

Hardware Quick Reference LANCOM 1800VAW

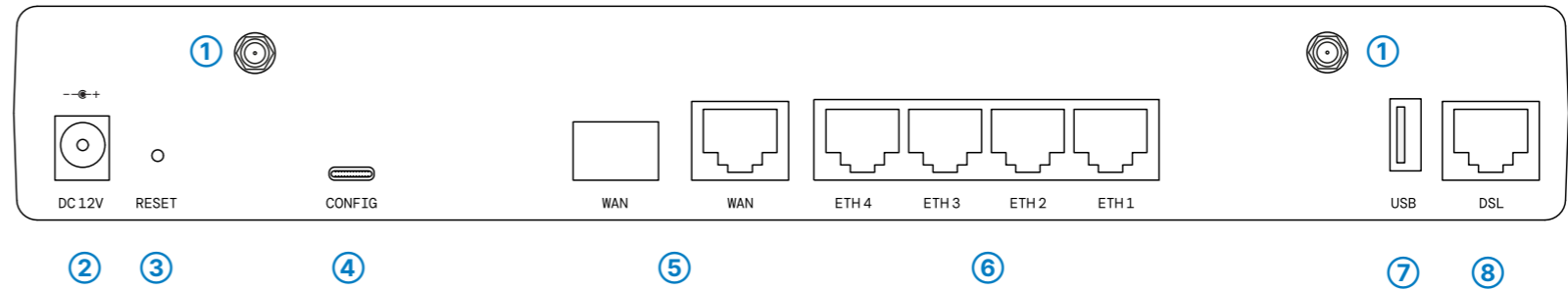

- 1 Wi-Fi antenna connectors**
Screw the supplied Wi-Fi antennas to the appropriate connectors.
- 2 Power supply connection socket**
Use only the supplied power adapter!
- 3 Reset button**
Short press > device restart
Long press > device reset
- 4 Serial USB-C configuration interface**
A USB-C cable can be used for optional configuration of the device on the serial console. (cable not included)

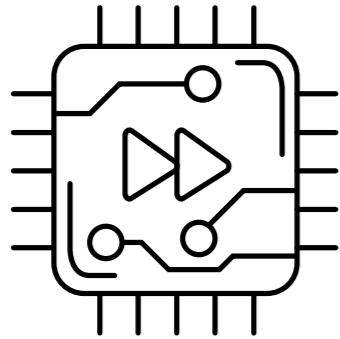
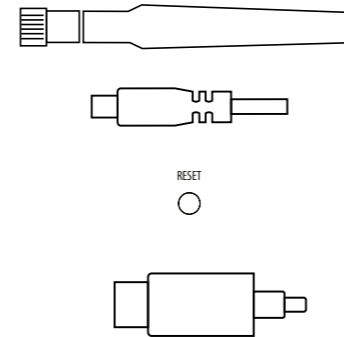

- 5 WAN interfaces (SFP / TP combo port)**
Insert a suitable LANCOM SFP module (e.g. 1000Base-SX or 1000Base-LX) into the WAN SFP interface. Choose a cable compatible with the SFP module and connect it as described in the SFP module's mounting instructions www.lancom-systems.com/SFP-module-MI (SFP module and cable are not included).

If desired, alternatively connect the WAN TP interface to a WAN modem using an Ethernet cable.

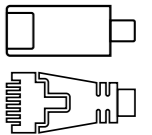

- 6 Ethernet interfaces**
Use the cable with the kiwi-colored connectors to connect one of the interfaces ETH 1 to ETH 4 to your PC or a LAN switch.

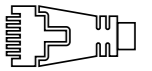

- 7 USB interface**
Connect a USB data medium or a USB printer to the USB interface. (cable not supplied)

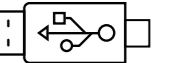

- 8 VDSL / ADSL interface**
Connect the VDSL interface and the TAE socket of the provider using the enclosed DSL cable for the IP-based connection. (For more information, please contact your Internet provider).



Before initial startup, please make sure to take notice of the information regarding the intended use in the enclosed installation guide!

Operate the device only with a professionally installed power supply at a nearby power socket that is freely accessible at all times.

The power plug of the device must be freely accessible.

Please note that support for third-party accessories is not provided.



Please observe the following when setting up the device

- When setting up on the table, use the enclosed self-adhesive rubber pads, if applicable.
- Do not rest any objects on top of the device and do not stack multiple devices.
- Keep all ventilation slots of the device clear of obstruction.
- Rack installation with the optional LANCOM [CPE blackline Rack Mount](#) / [CPE blackline Rack Mount Plus](#) (separately available)

LED description & technical details

Hardware Quick Reference LANCOM 1800VAW

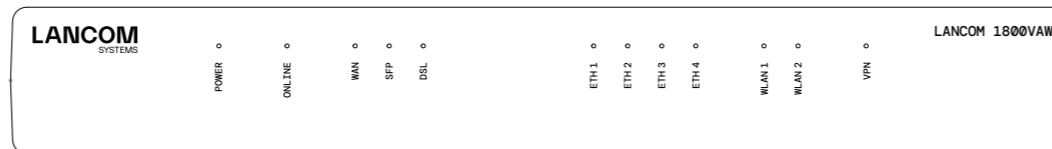
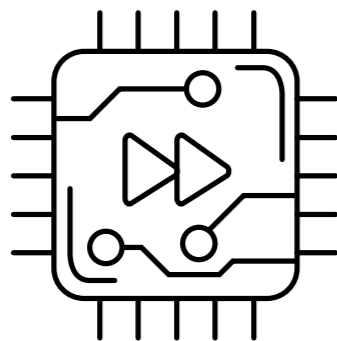

A **B** **C** **D** **E**

F **G** **H**

A Power

Off	Device switched off
Blue, permanently*	Device ready for operation or device paired and LANCOM Management Cloud (LMC) accessible.
1x blue, inverse blinking*	Connection to LMC active, pairing OK, device not claimed
2x blue, inverse blinking*	Pairing error or LMC activation code/ PSK not present.
3x blue, inverse blinking*	LMC not reachable resp. communication error

B Online

Off	WAN connection not active
Blue, blinking	WAN connection in progress (e.g. PPP negotiation)
Blue, permanently	WAN connection active

C WAN

Off	No link available / interface switched off
Blue, permanently	Link available, no data transmission
Blue, flickering	Data transmission

D SFP

Off	No link available / interface switched off
Blue, permanently	Link available, no data transmission
Blue, flickering	Data transmission

E DSL

Off	Interface switched off
Blue, blinking / fast blinking	DSL Handshake DSL Training
Blue, permanently	DSL Sync
Blue, flickering	Data transmission
Blue, flashing	Hardware error

F ETH1 - ETH4

Off	No link available or interface switched off
Blue, permanently	Link available, no data transmission
Blue, flickering	Data transmission

G WLAN 1 / WLAN 2

Off	No Wi-Fi network defined or Wi-Fi module disabled. No beacons are sent from the Wi-Fi module.
Blue, blinking	DFS Scanning or other scan process
Blue, permanently	At least one Wi-Fi network defined and Wi-Fi module activated. Beacons are sent from the Wi-Fi module.

H VPN

Off	No VPN connection active
Blue, blinking	VPN connection in progress
Blue, permanently	VPN connection active

Hardware

Power supply	12 V DC, external power adapter For an overview of the power supplies compatible with your device, see www.lancom-systems.com/kb/power-supplies .
Environment	Temperature range 0 – 40 °C; humidity 0 – 95 %; non-condensing
Housing	Robust plastic housing, connectors on the back, prepared for wall mounting; dimensions 293 × 44 × 190 mm (W x H x D)
Fan	1 quiet fan

Interfaces

VDSL2	VDSL2 acc. to ITU G.993.2; profiles 8a, 8b, 8c, 8d, 12a, 12b, 17a, 30a, 35b VDSL2 Supervectoring acc. to ITU G.993.2 (Annex Q) VDSL2 vectoring acc. to ITU G.993.5 (G.Vector) Compatible with VDSL2 and with Deutsche Telekom's U-R2 connection (1TR112) ADSL2+ over ISDN acc. to ITU G.992.5 Annex B/J with DPBO, ITU G.992.3 and ITU G.992.1 ADSL2+ over POTS acc. to ITU G.992.5 Annex A/M with DPBO, ITU G.992.3 and ITU G.992.1 Supports only one virtual circuit in ATM (VPI-VCI pair) at a time
WAN (Combo port) SFP / TP	WAN SFP: Slot for small form-factor pluggable Gigabit Ethernet transceiver (mini-GBIC). Compatible with optional LANCOM SFP modules for fiber optic connections. Switched as WAN port at delivery, can be configured as LAN port. WAN TP: 10 / 100 / 1000 Base-TX, Autosensing Full duplex, Auto node hub
ETH	4 individual 10 / 100 / 1000-Mbps Fast Ethernet ports; operate as switch ex-factory. Up to 3 ports can be switched as additional WAN ports.
USB	USB 2.0 Hi-Speed host port for connecting USB printers (USB print server), serial devices (COM-port servers), or USB data media (FAT file system)
Wi-Fi	2 SMA connectors for the supplied dual-band Wi-Fi antennas; Frequency bands: 2400-2483.5 MHz (ISM) and 5150-5725 MHz (country-specific restrictions possible); Radio channels 2.4 GHz: Up to 13 channels, max. 3 non-overlapping (2.4 GHz band); Radio channels 5 GHz: Up to 26 non-overlapping channels (available channels depending on country-specific regulation and associated with automatic, dynamic DFS channel selection)
Configuration interface	Serial USB-C configuration interface

WAN protocols

Ethernet	PPPoE, Multi-PPPoE, ML-PPP, PPTP (PAC or PNS) and IPoE (with or without DHCP)
----------	---

Package content

Cable	1 DSL cable for an IP-based line, 4.25 m; 1 Ethernet cable, 3m
Antennas	2 external 3 dBi dipole dual band antennas
Power adapter	External power adapter

*) The additional power LED statuses are displayed in 5-seconds rotation if the device is configured to be managed by the LANCOM Management Cloud.

This product contains separate open-source software components which are subject to their own licenses, in particular the General Public License (GPL). The license information for the device firmware (LCOS) is available on the device's WEBconfig interface under "Extras > License information". If the respective license demands, the source files for the corresponding software components will be made available on a download server upon request.

Hereby, LANCOM Systems GmbH | Adenauerstrasse 20/B2 | D-52146 Wuersele, declares that this device is in compliance with Directives 2014/30/EU, 2014/53/EU, 2014/35/EU, 2011/65/EU, and Regulation (EC) No. 1907/2006. The full text of the EU Declaration of Conformity is available at the following Internet address: www.lancom-systems.com/doc



LANCOM
SYSTEMS



Cloud-ready