



Reference Manual LCOS 8.82

Contents

1 About this documentation.....	22
1.1 Constituents of this documentation.....	22
1.1.1 LCOS, the operating system of LANCOM devices.....	23
1.1.2 Validity.....	23
1.1.3 Security settings.....	23
1.1.4 This documentation was created by	23
2 System design.....	25
2.1 Introduction.....	25
3 Configuration and management.....	27
3.1 Configuration tools and approaches.....	27
3.1.1 What is the difference between these three possibilities?.....	27
3.2 Configuration software.....	27
3.3 Searching and configuring devices.....	28
3.4 Configuration with LANconfig.....	29
3.4.1 Starting LANconfig.....	29
3.4.2 Switch graphical user interface language.....	31
3.4.3 Project management with LANconfig.....	32
3.4.4 User-specific settings for LANconfig.....	33
3.4.5 Customizing the toolbar.....	34
3.4.6 Automatic backup of configuration with LANconfig.....	35
3.4.7 Directory structure.....	35
3.4.8 Better overview in LANconfig with more columns.....	36
3.4.9 Multithreading.....	37
3.4.10 Manual and automatic searches for firmware updates.....	38
3.4.11 Password protection for SNMP read-only access.....	41
3.4.12 Device-specific settings for communications protocols.....	42
3.4.13 LANconfig behavior at Windows startup.....	44
3.4.14 Choice of Wizard or configuration dialog.....	46
3.4.15 WLAN configuration with the wizards in LANconfig.....	47
3.4.16 Addition(s) to LCOS 8.00.....	49
3.4.17 Addition(s) to LCOS 8.50.....	50
3.4.18 Addition(s) to LCOS 8.60.....	62
3.4.19 Addition(s) to LCOS 8.80.....	72
3.4.20 Addition(s) to LCOS 8.82.....	77
3.5 Group configuration with LANconfig.....	83
3.5.1 Create a group configuration.....	84
3.5.2 Update device configurations.....	85
3.5.3 Update group configurations.....	86
3.5.4 Using multiple group configurations.....	86
3.5.5 Transferring device configurations to similar models.....	87

3.5.6 Addition(s) to LCOS 8.60.....	88
3.6 LANmonitor—know what's going on.....	95
3.6.1 Extended display options.....	96
3.6.2 Enquiry of the CPU and Memory utilization over SNMP.....	96
3.6.3 Monitor Internet connection.....	96
3.6.4 Display functions in LANmonitor.....	98
3.6.5 Connection diagnosis with LANmonitor.....	100
3.6.6 Addition(s) to LCOS 7.70.....	102
3.6.7 Addition(s) to LCOS 7.80.....	105
3.6.8 Addition(s) to LCOS 8.50.....	106
3.6.9 Addition(s) to LCOS 8.80.....	109
3.7 Visualization of larger WLANs with WLANmonitor.....	113
3.7.1 Start the LANCOM WLANmonitor.....	113
3.7.2 Search for access points.....	113
3.7.3 Add access points.....	114
3.7.4 Organize access points.....	114
3.7.5 Rogue AP and rogue client detection with the WLANmonitor.....	115
3.8 Configuration with WEBconfig.....	118
3.8.1 Secure with HTTPS.....	118
3.8.2 Access with WEBconfig.....	119
3.8.3 Network without a DHCP server.....	119
3.8.4 Network with DHCP server.....	120
3.8.5 Login.....	120
3.8.6 Setup Wizards.....	121
3.8.7 System information.....	122
3.8.8 Configuration.....	124
3.8.9 LCOS menu tree.....	125
3.8.10 File management.....	125
3.8.11 Extras.....	125
3.8.12 HTTP session.....	126
3.9 Configuration with other tools.....	127
3.9.1 Telnet.....	127
3.9.2 SNMP.....	135
3.9.3 Encrypted configuration with SSH access.....	135
3.9.4 SSH authentication.....	136
3.9.5 ISDN Remote configuration via Dial-Up Network.....	137
3.9.6 Addition(s) to LCOS 8.80.....	140
3.10 Working with configuration files.....	146
3.10.1 Backup copies of configuration.....	146
3.10.2 Convenient series configuration.....	146
3.10.3 Running function.....	146
3.11 New firmware with FirmSafe.....	146
3.11.1 This is how FirmSafe works.....	147
3.11.2 Asymmetric FirmSafe.....	147

3.11.3 How to load new software.....	148
3.12 Load files directly from a TFTP or HTTP server into the device.....	150
3.12.1 TFTP.....	150
3.12.2 Loading firmware, device configuration or script via HTTP(S).....	151
3.12.3 Loading firmware, device configuration or script via HTTP(S) or TFTP.....	151
3.13 How to reset the device?.....	153
3.14 Addition(s) to LCOS 7.80.....	154
3.14.1 Deactivating Ethernet interfaces.....	154
3.15 Addition(s) to LCOS 8.20.....	154
3.15.1 Automatic uploading of firmware, configuration and scripts.....	154
3.16 Addition(s) to LCOS 8.80.....	159
3.16.1 Setting the device time from GPS.....	159
4 Advanced management.....	162
4.1 Scripting.....	162
4.1.1 Applications.....	162
4.1.2 Scripting function.....	163
4.1.3 Generating script files.....	163
4.1.4 Uploading configuration commands and script files.....	165
4.1.5 Multiple parallel script sessions.....	167
4.1.6 Scripting commands.....	167
4.1.7 Addition(s) to LCOS 8.80.....	170
4.2 Rollout Wizard.....	172
4.2.1 General settings in the Rollout Wizard.....	172
4.2.2 Variables.....	173
4.2.3 Actions to be executed by the Rollout Wizard.....	174
4.2.4 Actions for managing the Rollout Wizard.....	175
4.2.5 Addition(s) to LCOS 8.50.....	175
4.3 LANCOM Layer 2 Management protocol (LL2M).....	192
4.3.1 Introduction.....	192
4.3.2 Configuration of the LL2M server.....	193
4.3.3 Commands for the LL2M client.....	193
4.4 Messaging.....	194
4.4.1 Example: Broken connection alert as an SMS to a mobile telephone.....	195
4.4.2 Suppress messaging in case of re-connects with a DSL connection	196
4.4.3 Addition(s) to LCOS 7.70.....	196
4.5 Managing rights for different administrators.....	197
4.5.1 Rights for the administrators.....	197
4.5.2 Administrators' access via TFTP and SNMP.....	198
4.5.3 Configuration of user rights.....	199
4.5.4 Limitation of the configuration commands.....	201
4.5.5 TCP port tunnel.....	202
4.6 Named loopback addresses.....	203
4.6.1 Loopback addresses with ICMP polling.....	204
4.6.2 Loopback addresses for time servers.....	205

4.6.3 Loopback addresses for SYSLOG clients.....	205
4.7 Addition(s) to LCOS 8.00.....	206
4.7.1 Automatic upload of firmware or configuration from external data media.....	206
4.7.2 Alternative boot config.....	209
4.8 Addition(s) to LCOS 8.50.....	213
4.8.1 The commands LoadFirmware, LoadConfig, LoadScript and LoadFile.....	213
4.8.2 Enhanced Sysinfo.....	217
4.9 Addition(s) to LCOS 8.60.....	219
4.9.1 Configurable action for alive test.....	219
4.10 Addition(s) to LCOS 8.80.....	221
4.10.1 SYSLOG accounting is disabled by default.....	221
4.10.2 Boot-persistent SYSLOG, event log and boot log.....	221
4.10.3 SYSLOG: Delete old messages.....	223
4.10.4 Logging configuration changes made via the command line.....	225
4.10.5 SYSLOG: Change to the default order.....	226
5 Diagnosis.....	228
5.1 Trace information—for advanced users	228
5.1.1 How to start a trace.....	228
5.1.2 Overview of the keys.....	228
5.1.3 Overview of the parameters.....	228
5.1.4 Combination commands.....	230
5.1.5 Trace filters.....	230
5.1.6 Examples of traces.....	230
5.1.7 Recording traces.....	231
5.2 Tracing with LANmonitor.....	231
5.2.1 Introduction.....	232
5.2.2 Configuring the trace dumps with the Trace Wizard.....	233
5.2.3 LCOS menu tree of the trace dumps.....	234
5.2.4 Display of trace data.....	236
5.2.5 Backing up and restoring the trace configuration.....	237
5.2.6 Backing up and restoring the trace data.....	237
5.2.7 Backup settings for traces.....	237
5.2.8 Saving support file.....	237
5.2.9 Addition(s) to LCOS 8.50.....	238
5.3 SYSLOG.....	250
5.3.1 Introduction.....	250
5.3.2 Structure of SYSLOG messages.....	251
5.3.3 Configuring SYSLOG using LANconfig.....	253
5.3.4 Configuring SYSLOG using Telnet or WEBconfig.....	254
5.3.5 Addition(s) to LCOS 8.80.....	256
5.3.6 Addition(s) to LCOS 8.82.....	257
5.4 The ping command.....	260
5.5 Monitoring the switch.....	262
5.6 Cable testing.....	262

5.7 Addition(s) to LCOS 8.80.....	263
5.7.1 Trace output for the XML interface.....	263
5.7.2 Packet capturing.....	264
6 Security.....	266
6.1 Protection for the configuration.....	266
6.1.1 Password protection.....	266
6.1.2 Login barring.....	267
6.1.3 Restriction of the access rights on the configuration.....	267
6.2 Protecting the ISDN connection.....	270
6.2.1 Identification control.....	270
6.2.2 Callback	271
6.3 Location verification by ISDN or GPS.....	272
6.3.1 GPS location verification.....	272
6.3.2 ISDN location verification.....	272
6.3.3 Configuring location verification.....	272
6.4 The security checklist.....	276
6.5 Addition(s) to LCOS 8.60.....	279
6.5.1 Support for TLS 1.1 / 1.2.....	279
7 Routing and WAN -connections.....	280
7.1 General information	280
7.1.1 Bridges for standard protocols.....	280
7.1.2 What happens in the case of a request from the LAN?.....	280
7.2 IP routing.....	281
7.2.1 The IP routing table.....	281
7.2.2 Policy-based routing.....	283
7.2.3 Local routing.....	284
7.2.4 Dynamic routing with IP RIP.....	285
7.2.5 SYN/ACK speedup.....	289
7.3 Advanced Routing and Forwarding.....	289
7.3.1 Introduction.....	289
7.3.2 Defining networks and assigning interfaces.....	291
7.3.3 Assigning logical interfaces to bridge groups.....	292
7.3.4 Interfaces tags for remote sites.....	293
7.3.5 Virtual routers.....	294
7.3.6 NetBIOS proxy.....	295
7.4 Configuration of remote stations.....	295
7.4.1 Peer list.....	296
7.4.2 Layer list.....	297
7.5 IP masquerading.....	298
7.5.1 Simple masquerading.....	298
7.5.2 Inverse masquerading.....	299
7.6 Demilitarized Zone (DMZ).....	301
7.6.1 Assigning interfaces to the DMZ.....	301
7.6.2 Assigning network zones to the DMZ.....	302

7.6.3 Address check with DMZ and intranet interfaces.....	302
7.6.4 Unmasked Internet access for server in the DMZ.....	303
7.7 Multi-PPPoE.....	304
7.7.1 Example application: Home-Office with private Internet access.....	304
7.7.2 Configuration.....	304
7.8 Load balancing.....	305
7.8.1 DSL port mapping.....	306
7.8.2 DSL-channel bundling (MLPPPoE).....	308
7.8.3 Dynamic load balancing.....	308
7.8.4 Static load balancing.....	309
7.8.5 Configuration of load balancing.....	309
7.9 N:N mapping.....	311
7.9.1 Application examples.....	311
7.9.2 Configuration.....	313
7.10 Establishing connection with PPP.....	315
7.10.1 The protocol.....	315
7.10.2 Everything o.k.? Checking the line with LCP.....	316
7.10.3 Assignment of IP addresses via PPP.....	317
7.10.4 Settings in the PPP list.....	317
7.10.5 The meaning of the DEFAULT remote site.....	318
7.10.6 RADIUS authentication of PPP connections.....	319
7.11 DSL dial-in over PPTP.....	319
7.11.1 Configuration of PPTP.....	319
7.11.2 Addition(s) to LCOS 7.80.....	320
7.12 Extended connection for flat rates—Keep-alive.....	321
7.12.1 Configuration of Keep-alive function.....	321
7.13 Callback functions.....	322
7.13.1 Callback for Microsoft CBCP.....	322
7.13.2 Fast callback	323
7.13.3 Callback with RFC 1570 (PPP LCP extensions).....	323
7.13.4 Overview of configuration of callback function.....	323
7.14 ISDN Channel bundling with MLPPP.....	324
7.14.1 Two methods of channel bundling.....	324
7.14.2 Here's how to configure your system to combine channels.....	325
7.15 Operating a modem over the serial interface.....	325
7.15.1 Introduction.....	325
7.15.2 System requirements.....	326
7.15.3 Installation.....	326
7.15.4 Set the serial interface to modem operation.....	326
7.15.5 Configuration of modem parameters.....	327
7.15.6 Direct entry of AT commands.....	329
7.15.7 Statistics.....	329
7.15.8 Trace output.....	329
7.15.9 Configuration of remote sites for V.24 WAN interfaces.....	330

7.15.10 Configuration of a backup connection on the serial interface.....	331
7.15.11 Contact assignment of modem adapter kit	331
7.16 Manual definition of the MTU	331
7.16.1 Configuration.....	332
7.16.2 Statistics.....	332
7.17 WAN RIP.....	332
7.18 The rapid spanning tree protocol.....	333
7.18.1 Classic and rapid spanning tree.....	333
7.18.2 Improvements from rapid spanning tree.....	334
7.18.3 Configuring the Spanning Tree Protocol.....	334
7.18.4 Status reports via the Spanning Tree Protocol.....	336
7.19 The Action table.....	338
7.19.1 Introduction.....	338
7.19.2 Actions for Dynamic DNS.....	338
7.19.3 Further example actions.....	341
7.19.4 Configuration.....	342
7.20 Using the serial interface in the LAN.....	344
7.20.1 Introduction	344
7.20.2 Operating modes.....	345
7.20.3 Serial interface configuration.....	345
7.20.4 Configuring the COM port server.....	346
7.20.5 WAN device configuration.....	350
7.20.6 Serial connection status information.....	350
7.20.7 COM-port adapters.....	353
7.20.8 Addition(s) to LCOS 7.80.....	353
7.21 Addition(s) to LCOS 7.80.....	356
7.21.1 Routing of local services/ARP handling switchable	356
7.22 Addition(s) to LCOS 8.20.....	356
7.22.1 VDSL.....	356
7.23 Addition(s) to LCOS 8.80.....	361
7.23.1 Default mode in the DSLoL interface.....	361
8 Firewall.....	362
8.1 Threat analysis.....	362
8.1.1 The dangers.....	362
8.1.2 The ways of the perpetrators.....	362
8.1.3 The methods.....	363
8.1.4 The victims.....	363
8.2 What is a Firewall?.....	363
8.2.1 Tasks of a Firewall.....	364
8.2.2 Different types of Firewalls.....	364
8.3 The LANCOM Firewall.....	367
8.3.1 How the LANCOM Firewall inspects data packets.....	368
8.3.2 Special protocols.....	369
8.3.3 General settings of the Firewall.....	371

8.3.4 Parameters of Firewall rules.....	373
8.3.5 Alerting functions of the Firewall.....	377
8.3.6 Strategies for Firewall settings.....	381
8.3.7 Hints for setting the Firewall.....	382
8.4 Configuring the firewall with LANconfig.....	385
8.4.1 Firewall wizard.....	385
8.4.2 Definition of firewall objects.....	385
8.4.3 Defining firewall rules.....	388
8.5 Configuring firewall rules with WEBconfig or Telnet.....	390
8.5.1 Rule table.....	390
8.5.2 Object table.....	391
8.5.3 Action table.....	392
8.6 Firewall diagnosis.....	392
8.6.1 The Firewall table.....	392
8.6.2 The filter list.....	394
8.6.3 The connection list.....	395
8.6.4 Port block list.....	397
8.6.5 Host block list.....	397
8.7 Firewall limitations.....	398
8.8 Protection against break-in attempts: Intrusion Detection.....	398
8.8.1 Examples for break-in attempts.....	398
8.8.2 Configuration of the IDS.....	399
8.9 Protection against "Denial of Service" attacks.....	399
8.9.1 Examples of Denial of Service Attacks.....	399
8.9.2 Configuration of DoS blocking.....	401
8.9.3 Configuration of ping blocking and Stealth mode.....	402
8.10 Addition(s) to LCOS 7.80.....	402
8.10.1 Increased DoS threshold value for central devices.....	402
8.11 Addition(s) to LCOS 8.82.....	404
8.11.1 Source tags for firewall rules.....	404
9 IPv6.....	405
9.1 IPv6 basics.....	405
9.1.1 Why use IPv6-standard IP addresses?.....	405
9.1.2 IP address structure according to the IPv6 standard.....	405
9.1.3 Stages of migration.....	406
9.2 IPv6 tunneling technologies.....	406
9.2.1 6in4 tunneling.....	406
9.2.2 6rd tunneling.....	407
9.2.3 6to4 tunneling.....	407
9.3 DHCPv6.....	408
9.3.1 DHCPv6 server.....	408
9.3.2 DHCPv6 client.....	408
9.4 IPv4 VPN tunnel via IPv6.....	408
9.4.1 Setup Wizard – Setting up an IPv4 VPN connection via IPv6.....	409

9.5 IPv6 firewall.....	410
9.5.1 Function.....	410
9.5.2 Configuration.....	410
9.5.3 Default entries for the IPv6 firewall rules.....	410
9.5.4 IPv6 firewall log table.....	410
9.6 Additions to the Setup menu.....	412
9.6.1 Tunnel.....	412
9.6.2 Router advertisement.....	422
9.6.3 DHCPv6.....	433
9.6.4 Relay agent.....	447
9.6.5 Network.....	448
9.6.6 Firewall.....	452
9.6.7 LAN interfaces.....	474
9.6.8 WAN interfaces.....	478
9.6.9 Operating.....	481
9.6.10 Forwarding.....	481
9.6.11 Router.....	481
9.6.12 IPv6 address.....	483
9.7 Additions to the Status menu.....	484
9.7.1 Log table.....	484
9.8 Additional command-line commands.....	485
9.8.1 IPv6 addresses.....	485
9.8.2 IPv6 prefixes.....	486
9.8.3 IPv6 interfaces.....	486
9.8.4 IPv6 neighbor cache.....	487
9.8.5 IPv6 DHCP server.....	488
9.8.6 IPv6 DHCP client.....	488
9.8.7 IPv6 route.....	488
9.8.8 Release IPv6 address.....	488
9.8.9 Ping command for IPv6.....	488
9.8.10 Overview of parameters.....	488
9.9 Enhancements to LANconfig.....	491
9.9.1 IPv6 configuration menu.....	491
9.9.2 Settings in the PPP list.....	500
9.9.3 IP routing tables.....	501
9.9.4 Separate views for the IPv4 and IPv6 firewalls.....	503
9.9.5 IPv6 DNS hosts in the DNS list	503
9.9.6 Configuring the IPv6 firewall rules.....	503
9.10 Tutorials.....	514
9.10.1 Setting up IPv6 Internet access.....	514
9.10.2 Setting up a 6to4 tunnel.....	522
9.11 Addition(s) to LCOS 8.82.....	528
9.11.1 Reconfigure function of the DHCPv6 server.....	528
10 Quality of Service.....	536

10.1 Why QoS?	536
10.2 Which data packets to prefer?	536
10.2.1 What is DiffServ?	537
10.2.2 Guaranteed minimum bandwidths	537
10.2.3 Limited maximum bandwidths	538
10.3 The queue concept	538
10.3.1 Queues in transmission direction	538
10.3.2 Queues for receiving direction	540
10.4 Reducing the packet length	540
10.5 QoS parameters for Voice over IP applications	541
10.6 QoS in sending or receiving direction	544
10.7 QoS configuration	545
10.7.1 Evaluating ToS and DiffServ fields	545
10.7.2 Defining minimum and maximum bandwidths	547
10.7.3 Adjusting transfer rates for interfaces	548
10.7.4 Sending and receiving direction	548
10.7.5 Reducing the packet length	549
10.8 QoS for WLANs according to IEEE 802.11e (WMM/WME)	550
11 Virtual Private Networks (VPN)	551
11.1 What does VPN offer?	551
11.1.1 Conventional network infrastructure	551
11.1.2 Networking via the Internet	552
11.1.3 Private IP addresses on the Internet?	552
11.1.4 Secure communications via the Internet?	553
11.2 LANCOM VPN: an overview	553
11.2.1 VPN example application	553
11.2.2 LANCOM VPN functions	554
11.3 VPN connections in detail	554
11.3.1 LAN-LAN coupling	555
11.3.2 Dial-in connections (Remote Access Service)	555
11.4 What is LANCOM Dynamic VPN ?	555
11.4.1 A look at IP addressing	556
11.4.2 This is how LANCOM Dynamic VPN works	556
11.4.3 Information to the Dynamic VPN registration	559
11.5 Configuration of VPN connections	560
11.5.1 VPN tunnel: Connections between VPN gateways	561
11.5.2 Set up VPN connections with the Setup Wizard	561
11.5.3 1-Click-VPN for networks (site-to-site)	562
11.5.4 1-Click-VPN for LANCOM Advanced VPN Client	563
11.5.5 Inspect VPN rules	564
11.5.6 Manually setting up VPN connections	565
11.5.7 IKE config mode	565
11.5.8 Prepare VPN network relationships	566
11.5.9 Configuration with LANconfig	568

11.5.10 Configuration with WEBconfig.....	573
11.5.11 Establishing Security Associations collectively.....	576
11.5.12 Diagnosis of VPN connections.....	577
11.6 Working with digital certificates.....	577
11.6.1 Basics.....	577
11.6.2 Advantages of certificates.....	580
11.6.3 Structure of certificates.....	581
11.6.4 Security.....	583
11.6.5 Certificates for establishing VPN connections.....	583
11.6.6 Certificates from certificate service providers.....	584
11.6.7 Establishing a proprietary CA.....	584
11.6.8 Requesting a certificate with Stand-alone Windows CA.....	584
11.6.9 Export the certificate to a PKCS#12 file.....	588
11.6.10 Create certificates with OpenSSL.....	591
11.6.11 Upload certificates to the LANCOM.....	592
11.6.12 Storing and uploading certificates.....	593
11.6.13 Set up VPN connections to support certificates.....	595
11.6.14 Set up certificate-based VPN connections with the Setup Wizard.....	599
11.6.15 Set up LANCOM Advanced VPN Client for certificate connections.....	602
11.6.16 Simplified RAS with certificates.....	604
11.6.17 Simplified network connection with certificates – proadaptive VPN.....	605
11.6.18 Request certificates using CERTREQ.....	606
11.6.19 Certificate revocation list - CRL.....	606
11.6.20 Diagnosis of VPN certificate connections.....	608
11.6.21 Addition(s) to LCOS 8.00.....	609
11.6.22 Addition(s) to LCOS 8.50.....	609
11.7 Multi-level certificates for SSL/TLS.....	612
11.7.1 Introduction.....	612
11.7.2 SSL/TLS with multi-level certificates.....	613
11.7.3 VPN with multi-level certificates.....	613
11.8 Certificate enrollment via SCEP.....	613
11.8.1 SCEP server and SCEP client.....	613
11.8.2 Distributing certificates.....	614
11.8.3 Configuring SCEP.....	615
11.9 NAT Traversal (NAT-T).....	618
11.10 Extended Authentication Protocol (XAUTH).....	620
11.10.1 Introduction.....	620
11.10.2 XAUTH in LCOS.....	621
11.10.3 Configuring XAUTH.....	621
11.11 Backup via alternative VPN connection.....	622
11.11.1 Introduction.....	622
11.11.2 Backup-capable network infrastructure.....	623
11.11.3 Configuring the VPN backup.....	625
11.12 Specific examples of connections.....	627

11.12.1 Static/static.....	628
11.12.2 Dynamic/static.....	628
11.12.3 Static/dynamic (with LANCOM Dynamic VPN).....	629
11.12.4 Dynamic/dynamic (with LANCOM Dynamic VPN).....	629
11.12.5 VPN connections: High availability with VPN load balancing.....	630
11.13 How does VPN work?.....	631
11.13.1 IPSec—The basis for LANCOM VPN.....	632
11.13.2 Alternatives to IPSec.....	632
11.14 The standards behind IPSec.....	633
11.14.1 IPSec modules and their tasks.....	633
11.14.2 Security Associations – numbered tunnels.....	633
11.14.3 Encryption of the packets – the ESP protocol.....	634
11.14.4 Authentication – the AH protocol.....	635
11.14.5 Key management – IKE.....	636
11.15 Addition(s) to LCOS 8.00.....	637
11.15.1 VPN Pathfinder.....	637
11.16 Addition(s) to LCOS 8.60.....	640
11.16.1 Improved phase 1 rekeying.....	640
11.16.2 MPPE encryption for PPTP tunnels.....	640
11.17 Addition(s) to LCOS 8.62.....	641
11.17.1 Default proposals for IKE and IPSec.....	641
11.17.2 myVPN.....	641
11.18 Addition(s) to LCOS 8.80.....	659
11.18.1 Deleting all VPN errors with one command.....	659
11.18.2 Default proposals for IKE and IPSec.....	660
11.18.3 Selecting DH group 14 for VPN connections.....	660
11.18.4 Replay detection	662
11.18.5 myVPN.....	663
11.18.6 Intelligent precalculation of DH keys.....	681
11.18.7 Additions to the Setup menu.....	683
11.18.8 Enhancements to LANconfig.....	686
11.19 Addition(s) to LCOS 8.82.....	686
11.19.1 Hash function SHA2-256 selectable via LANconfig.....	686
12 Virtual LANs (VLANs).....	689
12.1 What is a Virtual LAN?.....	689
12.2 This is how a VLAN works.....	689
12.2.1 Frame tagging.....	690
12.2.2 Conversion within the LAN interconnection.....	690
12.2.3 VLAN Q-in-Q tagging.....	691
12.2.4 Application examples.....	691
12.3 Configuration of VLANs.....	692
12.3.1 VLAN and ARF.....	692
12.3.2 VLAN and WLAN Controllers.....	692
12.3.3 General settings.....	693

12.3.4 The network table.....	694
12.3.5 The port table.....	694
12.4 Configurable VLAN IDs.....	695
12.4.1 Different VLAN IDs per WLAN client.....	695
12.4.2 VLAN tags for DSL interfaces.....	696
12.4.3 Special VLAN ID for DSLoL interfaces.....	696
12.5 VLAN tags on layer 2/3 in the Ethernet.....	696
12.5.1 Introduction.....	696
12.5.2 Configuring VLAN tagging on layer 2/3.....	697
12.6 Addition(s) to LCOS 8.60.....	698
12.6.1 Group key per VLAN.....	698
13 Wireless LAN (WLAN).....	701
13.1 Introduction.....	701
13.2 Application scenarios.....	701
13.2.1 Infrastructure mode.....	702
13.2.2 Hotspot or guest access.....	702
13.2.3 Managed mode.....	702
13.2.4 WLAN bridge (point-to-point).....	703
13.2.5 WLAN bridge in relay mode.....	703
13.2.6 WLAN bridge to an access point – managed and unmanaged mixed.....	704
13.2.7 Wireless Distribution System (point-to-multipoint).....	704
13.2.8 Client mode.....	704
13.2.9 Client mode with mobile objects in industry.....	705
13.3 WLAN standards.....	705
13.3.1 Data rates in compatibility mode.....	705
13.3.2 IEEE 802.11n.....	706
13.3.3 IEEE 802.11a: 54 Mbps.....	712
13.3.4 IEEE 802.11h – ETSI 301 893.....	712
13.3.5 IEEE 802.11g: 54 Mbps.....	715
13.3.6 IEEE 802.11b: 11 Mbps.....	715
13.4 WLAN security	715
13.4.1 Basics	715
13.4.2 IEEE 802.11i /WPA2.....	716
13.4.3 TKIP and WPA	718
13.4.4 WEP	719
13.4.5 LEPS – LANCOM Enhanced Passphrase Security.....	719
13.4.6 Standard WEP encryption.....	720
13.4.7 Background WLAN scanning.....	723
13.5 Configuration of WLAN parameters.....	724
13.5.1 General WLAN settings.....	724
13.5.2 WLAN security.....	726
13.5.3 Selecting approved stations for the WLAN.....	731
13.5.4 Encryption settings.....	732
13.5.5 The physical WLAN interfaces.....	735

13.5.6 Point-to-point peers.....	745
13.5.7 The logical WLAN interfaces.....	746
13.5.8 IEEE 802.1x/EAP.....	754
13.5.9 Expert WLAN settings.....	755
13.5.10 WLAN routing (isolated mode).....	757
13.5.11 Addition(s) to LCOS 8.80.....	758
13.6 Configuring the client mode.....	763
13.6.1 Client settings.....	763
13.6.2 Set the SSID of the available networks.....	764
13.6.3 Encryption settings.....	764
13.6.4 Roaming.....	765
13.6.5 Addition(s) to LCOS 7.80.....	766
13.7 Configuring point-to-point connections.....	768
13.7.1 Geometric dimensioning of outdoor wireless network links.....	769
13.7.2 Antenna alignment for P2P operations.....	771
13.7.3 Measuring wireless bridges.....	773
13.7.4 Activating point-to-point operation mode.....	773
13.7.5 Configuration of P2P connections.....	774
13.7.6 Access points in relay mode.....	777
13.7.7 Security for point-to-point connections.....	777
13.7.8 Addition(s) to LCOS 8.50.....	778
13.7.9 Addition(s) to LCOS 8.60.....	779
13.8 Centralized WLAN Management.....	780
13.8.1 Starting position.....	780
13.8.2 Technical concepts.....	781
13.8.3 Configuration.....	785
13.8.4 Tutorial: Virtualization and guest access accounts via the LANCOM WLAN controller.....	804
13.8.5 Access point administration.....	814
13.8.6 Central firmware and script management.....	817
13.8.7 WLAN layer-3 tunneling.....	821
13.8.8 RADIUS.....	834
13.8.9 Dynamic VLAN assignment.....	836
13.8.10 Activating 802.1x accounting for logical WLANs in WLAN controllers.....	838
13.8.11 Displays and commands in LANmonitor.....	839
13.8.12 Automatic RF optimization.....	840
13.8.13 Channel-load display in WLC mode.....	841
13.8.14 Backing up the certificates.....	842
13.8.15 Backup solutions.....	843
13.8.16 Addition(s) to LCOS 8.82.....	847
13.9 Central firmware and script management.....	852
13.9.1 General settings for firmware management.....	853
13.9.2 Firmware management table.....	853
13.9.3 General settings for script management.....	854
13.9.4 Script management table.....	854

13.9.5 Internal script storage (script management without an HTTP server).....	854
13.10 DFS 2: Non-use of channels for weather radar.....	855
13.11 Bandwidth limits in the WLAN.....	855
13.11.1 Operating as an access point.....	856
13.11.2 Operating as a Client.....	856
13.12 Addition(s) to LCOS 7.70.....	857
13.12.1 APSD – Automatic Power Save Delivery.....	857
13.12.2 BFWA – higher transmission power for longer ranges.....	858
13.13 Addition(s) to LCOS 7.80.....	858
13.13.1 ARF network for IAPP.....	858
13.14 Addition(s) to LCOS 8.50.....	859
13.14.1 Alarm limits for WLAN devices.....	859
13.14.2 Interpoint alarm limits.....	860
13.14.3 IEEE 802.11e user priority converted into VLAN tags.....	861
13.15 Addition(s) to LCOS 8.60.....	862
13.15.1 Adjustable rate adaption algorithm.....	862
13.16 Addition(s) to LCOS 8.80.....	863
13.16.1 Spectral scan.....	863
13.16.2 WLAN band steering.....	873
13.16.3 STBC / LDPC.....	877
13.16.4 LANCOM-specific UUID information element for access points.....	882
13.16.5 DFS.....	882
13.16.6 PMK caching in the WLAN client mode.....	884
13.16.7 Pre-authentication in WLAN-client mode.....	887
13.16.8 Greenfield mode for access points with IEEE 802.11n.....	887
13.16.9 Separate RADIUS server for each SSID.....	888
13.17 Addition(s) to LCOS 8.82.....	893
13.17.1 Advanced ARP handling.....	893
13.17.2 Multicast and broadcasts in cells can be switched off.....	896
14 Public Spot.....	900
14.1 Introduction.....	900
14.1.1 What is a Public Spot?.....	900
14.1.2 Possible application scenarios.....	901
14.1.3 Overview of the Public Spot module.....	908
14.2 Setup and operation.....	910
14.2.1 Basic configuration.....	911
14.2.2 Security settings.....	930
14.2.3 Extended functions and settings.....	931
14.2.4 Alternative login methods.....	946
14.2.5 Default and customized authentication pages.....	979
14.3 Access to the Public Spot.....	988
14.3.1 Requirements for logging in.....	988
14.3.2 Logging in to the Public Spot.....	989
14.3.3 Session information.....	990

14.3.4	Logging out of the Public Spot.....	990
14.3.5	Advice and help.....	991
14.4	Tutorials for setting up and using Public Spots.....	992
14.4.1	Virtualization and guest access via WLAN controller with VLAN.....	992
14.4.2	Virtualization and guest access via WLAN controller without VLAN.....	1002
14.4.3	Setting up an external RADIUS server for user administration.....	1012
14.4.4	Internal and external RADIUS servers combined.....	1013
14.4.5	Checking WLAN clients with RADIUS (MAC filter).....	1016
14.4.6	Setting up an external SYSLOG server.....	1016
14.5	Appendix.....	1018
14.5.1	Commonly transmitted RADIUS attributes.....	1018
14.5.2	RADIUS attributes transmitted via WISPr.....	1023
14.5.3	Expert settings for the PMS interface.....	1023
15	Voice over IP (VoIP).....	1029
15.1	Introduction.....	1029
15.1.1	PC-to-PC communication	1029
15.1.2	PC-to-phone and phone-to-PC communication.....	1029
15.2	VoIP implementation in the LANCOM VoIP Router.....	1030
15.2.1	Example Applications.....	1030
15.2.2	The central position of the LANCOM VoIP Router.....	1032
15.3	Call switching: Call routing.....	1034
15.3.1	SIP proxy and SIP gateway.....	1034
15.3.2	User registration at the SIP proxy.....	1034
15.3.3	Number translation at network transitions.....	1037
15.3.4	The Call Manager.....	1037
15.3.5	Making telephone calls with the LANCOM VoIP Router.....	1038
15.3.6	Call hold, transfer call, connect call.....	1040
15.3.7	Transfer of DTMF tones.....	1041
15.3.8	Transfer toll information to the internal ISDN buses.....	1042
15.3.9	Supporting digital calls.....	1042
15.4	Configuration of VoIP parameters.....	1042
15.4.1	General settings.....	1043
15.4.2	Configuration of users.....	1044
15.4.3	Line configuration.....	1053
15.5	Call Manager Configuration.....	1064
15.5.1	Process of call routing.....	1064
15.5.2	Handling the calling party ID.....	1065
15.5.3	Call-routing table parameters.....	1066
15.5.4	Codecs.....	1071
15.5.5	Extended settings.....	1072
15.6	PBX functions for LANCOM VoIP Router.....	1073
15.6.1	Connect and forward call.....	1074
15.6.2	Spontaneous call management by the user.....	1077
15.6.3	Configure permanent call forwarding.....	1079

15.6.4 Fax via T.38 – Fax over IP (FoIP).....	1080
15.6.5 Hunt groups with call distribution.....	1081
15.6.6 Multi-login.....	1082
15.7 VoIP media proxy – Optimized management for SIP connections.....	1083
15.7.1 Multiple media streams in one SIP connection.....	1083
15.7.2 Management of media streams in case of an upstream SIP PBX.....	1084
15.7.3 Managing the media streams in the firewall.....	1084
15.7.4 Automatic QoS rules for media streams.....	1084
15.7.5 Handling subscribers using different codecs.....	1084
15.8 SIP-ID as switchboard number with trunk lines.....	1085
15.9 Switching at the SIP provider.....	1085
15.10 Handling canonical telephone numbers.....	1086
15.11 Processing Destination Domains.....	1086
15.11.1 Registration at upstream exchanges.....	1087
15.11.2 Switching internal calls.....	1087
15.12 ISDN interface configuration.....	1087
15.12.1 Point-to-multipoint and point-to-point connections.....	1087
15.12.2 Bus termination, life-line support and power relay.....	1088
15.12.3 Protocol setting.....	1089
15.12.4 ISDN connection timing.....	1089
15.13 Configuration examples.....	1090
15.13.1 VoIP telephony for stand-alone use.....	1090
15.13.2 Using VoIP telephony to extend the upstream ISDN PBX.....	1097
15.13.3 Using VoIP telephony to extend the downstream ISDN PBX.....	1102
15.13.4 Using VoIP telephony to supplement existing ISDN telephones.....	1106
15.13.5 Connecting to an upstream SIP PBX.....	1108
15.13.6 VoIP connectivity for locations without a SIP PBX.....	1111
15.13.7 The LANCOM VoIP Router at a P2P (point-to-point) connection.....	1116
15.13.8 SIP trunking.....	1117
15.13.9 Remote gateway.....	1119
15.14 Diagnosis of VoiP connections.....	1122
15.14.1 SIP traces.....	1122
15.14.2 Connection diagnosis with LANmonitor.....	1122
15.15 Addition(s) to LCOS 7.80.....	1124
15.15.1 Global settings, DiffServ for SIP & RTP.....	1124
15.16 Addition(s) to LCOS 8.60.....	1125
15.16.1 SIP ALG: Proxy for bypassing NAT in the router.....	1125
15.16.2 Restricting or preventing SIP registration over WAN connections.....	1131
15.17 Addition(s) to LCOS 8.62.....	1133
15.17.1 Default setting for WAN registration of a SIP user.....	1133
15.18 Addition(s) to LCOS 8.80.....	1134
15.18.1 Default setting for WAN registration of a SIP user.....	1134
16 High availability – backup solutions.....	1135
16.1 High availability for networks.....	1135

16.1.1	How is a network-connection disturbance detected?.....	1135
16.1.2	High-availability of lines – backup connections.....	1138
16.1.3	High-availability of gateways – redundant gateways with VPN load balancing.....	1140
16.1.4	High-availability of the Internet access – Multi-PPPoE.....	1141
16.1.5	Example applications.....	1141
16.2	Backup Solutions and Load Balancing with VRRP.....	1143
16.2.1	Introduction.....	1143
16.2.2	Virtual Router Redundancy Protocol.....	1143
16.2.3	Application scenarios.....	1148
16.2.4	Interaction with internal services.....	1150
16.2.5	VRRP in the WAN.....	1153
16.2.6	Configuration.....	1154
16.2.7	Status Information.....	1156
17	Office communication with LANCAPI.....	1158
17.1	What are the advantages of LANCAPI?.....	1158
17.2	The client and server principle.....	1158
17.2.1	Configuring the LANCAPI server.....	1158
17.2.2	Installing the LANCAPI client.....	1160
17.2.3	Configuration of the LANCAPI clients.....	1161
17.3	How to use the LANCAPI.....	1161
17.4	The LANCOM Systems CAPI Faxmodem.....	1162
17.4.1	Installation.....	1162
17.4.2	Faxing with the CAPI Faxmodem.....	1162
17.4.3	Faxing under Windows XP and Windows 2000.....	1162
17.5	LANCOM Faxmodem option.....	1162
17.6	Provided B channel protocols.....	1162
18	More services.....	1164
18.1	Automatic IP address administration with DHCP.....	1164
18.1.1	Introduction.....	1164
18.1.2	Configuring DHCP parametersLANconfig.....	1165
18.1.3	Configuring DHCP parameters with telnet or WEBconfig.....	1169
18.1.4	DHCP relay server.....	1173
18.1.5	Configuring clients.....	1174
18.1.6	Checking IP addresses in the LAN.....	1174
18.1.7	Addition(s) to LCOS 7.80.....	1174
18.1.8	Addition(s) to LCOS 8.00.....	1177
18.1.9	Addition(s) to LCOS 8.80.....	1178
18.2	Vendor Class and User Class Identifier.....	1179
18.3	DNS.....	1180
18.3.1	What does a DNS server do?.....	1180
18.3.2	DNS forwarding.....	1180
18.3.3	Setting up the DNS server.....	1181
18.3.4	URL blocking.....	1183
18.3.5	Dynamic DNS.....	1183

18.3.6 Addition(s) to LCOS 8.82.....	1185
18.4 Accounting.....	1188
18.4.1 Configuring accounting.....	1189
18.4.2 Snapshot configuration.....	1190
18.5 Call charge management.....	1190
18.5.1 Connection limits for DSL and cable modem.....	1191
18.5.2 Charge-based ISDN connection limits.....	1191
18.5.3 Time dependent ISDN connection limit.....	1192
18.5.4 Settings in the charge module.....	1192
18.6 Time server for the local net.....	1192
18.6.1 Configuration of the time server under LANconfig.....	1192
18.6.2 Configuration of the time server with WEBconfig or Telnet.....	1193
18.6.3 Configuring the NTP clients.....	1194
18.7 Scheduled Events.....	1196
18.7.1 Regular Execution of Commands.....	1196
18.7.2 CRON jobs with time delay.....	1196
18.7.3 Configuring the CRON job.....	1197
18.8 PPPoE Servers.....	1198
18.8.1 Introduction.....	1198
18.8.2 Example application.....	1199
18.8.3 Configuration.....	1201
18.9 Remote bridge.....	1202
18.10 RADIUS.....	1203
18.10.1 How RADIUS works.....	1204
18.10.2 Configuration of RADIUS as authenticator or NAS.....	1204
18.10.3 Configuring RADIUS as server.....	1210
18.10.4 Addition(s) to LCOS 7.70.....	1211
18.11 Extensions to the RADIUS server.....	1212
18.11.1 New authentication method.....	1212
18.11.2 EAP authentication.....	1212
18.11.3 RADIUS forwarding.....	1213
18.11.4 RADIUS server parameters.....	1214
18.11.5 Addition(s) to LCOS 7.80.....	1215
18.11.6 Addition(s) to LCOS 8.80.....	1217
18.11.7 Addition(s) to LCOS 8.82.....	1218
18.12 RADSEC.....	1222
18.12.1 Configuring RADSEC for the client.....	1222
18.12.2 Certificates for RADSEC.....	1222
18.13 Operating printers at the USB connector of the LANCOM.....	1223
18.13.1 Configuring the printer server in the LANCOM.....	1223
18.13.2 Printer configuration at the computer.....	1224
18.14 Addition(s) to LCOS 7.70.....	1227
18.14.1 IGMP snooping.....	1227
18.14.2 TACACS+.....	1236

18.15 Addition(s) to LCOS 8.00.....	1246
18.15.1 Basic HTTP file server for LCOS 8.0.....	1246
18.15.2 SSH client.....	1247
18.15.3 LANCOM Content Filter.....	1250
18.16 Addition(s) to LCOS 8.50.....	1279
18.16.1 Bandwidth restriction of the LAN interfaces.....	1279
18.17 Addition(s) to LCOS 8.80.....	1280
18.17.1 LLDP.....	1280
19 Appendix.....	1290
19.1 Error messages in LANmonitor.....	1290
19.1.1 General error messages.....	1290
19.1.2 VPN error messages.....	1290
19.2 SNMP Traps	1293
19.3 Radio channels.....	1294
19.3.1 Radio channels in the 2,4 GHz frequency band.....	1294
19.3.2 Radio channels in the 5 GHz frequency band.....	1294
19.3.3 Radio channels and frequency ranges for Indoor and Outdoor operating.....	1295
19.4 RFCs supported.....	1297
19.5 Glossary.....	1298

1 About this documentation

1.1 Constituents of this documentation

The documentation of this device includes the following:

- Installation Guide

In this getting started guide you find answers to the following questions:

- Which software needs to be installed for the configuration?
- How needs the device to be connected?
- How can the device be reached by LANconfig, WEBconfig or another interface?
- How do you start a setup assistant (e.g. for providing an internet access)?
- How do you make a hardware check?
- Where can you find more information and help?

- User's manual

The user's manual contains all information, which are important for starting up the device. In addition you find all technical specifications.

- Manual PBX functionalities (only models with VoIP support)

In the manual PBX functionalities you find a detailed step-by-step guide for using a LANCOM VoIP Router as a telephone system for a location. Also there are described the most important advices for the user and the connection of end devices.

- Reference manual

The reference manual completes the user's manual and describes topics in detail, which are valid for several models simultaneously. These are for example:

- Systems design of the LCOS operating system
- Configuration
- Management
- Diagnosis
- Security
- Routing and WAN functions
- Firewall
- Quality of Service (QoS)
- Virtual Private Networks (VPN)
- Virtual Local Networks (VLAN)
- Wireless Networks
- Voice communication in networks with Voice over IP (VoIP)
- Back up solutions
- LANCAPI
- Further server services (DHCP, DNS, charge management)

The description in the reference manual is geared to the configuration with LANconfig. For every LANconfig dialogue is given the associated path for the configuration with WEBconfig, e.g.:

LANconfig: Wireless LAN / 802.11i/WEP / WPA or Private WEP settings

WEBconfig: LCOS Menu Tree / setup / interfaces / WLAN / encryption

The path for the configuration with console/telnet is not explicit written, but can be deduced. The telnet path for the encryption setting is e.g.:

```
cd Setup/interfaces/WLAN/encryption
```

- Menu reference

The menu reference describes all parameter of LCOS, the operating system of all LANCOM devices. This description supports the user to configurate the devices with WEBconfig or telnet. The parameters in the menu reference are sorted the way they can be reached with WEBconfig. Every parameter is not only described, but you can find as well possible values and standards.

 You find all documents, which are not attached to your device in a printed version, as an acrobat document under www.lancom.de/download or on the attached product CD.

1.1.1 LCOS, the operating system of LANCOM devices

All LANCOM routers and LANCOM Wireless Access Points use the same operating system: LCOS. The operating system developed by LANCOM Systems itself is not attackable from the outside, and thus offers high security. The consistent use of LCOS ensures a comfortable and constant operation of all LANCOM products. The extensive feature set is available throughout all LANCOM products (provided respective support by hardware), and continuously receives further enhancements by free, regular software updates.

This reference manual applies to the following definitions of software, hardware and manufacturers:

- 'LCOS' describes the device-independent operating system
- 'LANCOM' stands as generic term for all LANCOM routers and LANCOM Router Access Points
- 'LANCOM Systems' stands as shortened form for the manufacturer, LANCOM Systems GmbH, Germany

1.1.2 Validity

The present reference manual applies to all LANCOM routers and LANCOM Router Access Points with firmware version 7.6 or better.

The functions and settings described in this reference manual are not supported by all models and/or all firmware versions. A table can be found in the appendix denoting the individual functions, from which firmware version they are supported in the respective devices.

Illustrations of devices, as well as screenshots always represent just examples, which need not necessarily correspond to the actual firmware version.

1.1.3 Security settings

For a carefree use of your device, we recommend to carry out all security settings (e.g. Firewall, encryption, access protection, charge lock), which are not already activated at the time of purchase of your device. The LANconfig wizard 'Check Security Settings' will support you accomplishing this. Further information regarding this topic can be found in chapter .

We ask you additionally to inform you about technical developments and actual hints to your product on our Web page www.lancom.eu, and to download new software versions if necessary.

1.1.4 This documentation was created by ...

... several members of our staff from a variety of departments in order to ensure you the best possible support when using your LANCOM product.

In case you encounter any errors, or just want to issue critics or enhancements, please do not hesitate to send an email directly to: info@lancom.de



Our online services www.lancom.eu are available to you around the clock should you have any queries regarding the topics discussed in this manual or require any further support. The area 'Support' will help you with many answers to frequently asked questions (FAQs). Furthermore, the knowledgebase offers you a large reserve of information. The latest drivers, firmware, utilities and documentation are constantly available for download. In addition, LANCOM support is available. For telephone numbers and contact addresses of LANCOM support, please see the enclosed leaflet or the LANCOM Systems website.

Information symbols

Very important instructions. Failure to observe this may result in damage.

Important instruction that should be observed.

Additional information that may be helpful but which is not required.

2 System design

2.1 Introduction

The LANCOM operating system LCOS is a collection of different software modules, the LANCOM devices themselves have different interfaces to the WAN and LAN. Depending on the particular application, data packets flow through different modules on their way from one interface to another.

The following block diagram illustrates in abstract the general arrangement of LANCOM interfaces and LCOS modules. In the course of this reference manual the descriptions of the individual functions will refer to this illustration to show important connections of the particular applications and to deduce the resulting consequences.

The diagram can thus explain for which data streams the firewall comes into play, or, in case of address translations (IP masquerading or N:N mapping), at which place which addresses are valid.

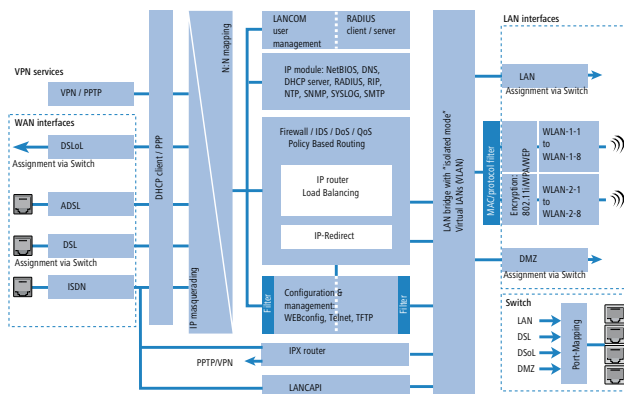

Notes regarding the respective modules and interfaces:

- The IP router takes care of routing data on IP connections between the interfaces from LAN and WAN.
- With IP redirect requests in the LAN are redirected to a specific computer
- The firewall (with the services "Intrusion Detection", "Denial of Service" and "Quality of Service") encloses the IP router like a shield. All connections via the IP router automatically flow through the firewall as well.
- LANCOM devices provide either a separate LAN interface or an integrated switch with multiple LAN interfaces as interfaces to the LAN.
- LANCOM Router access points resp. LANCOM routers with wireless modules offer additionally one or, depending on the respective model, also two wireless interfaces for the connection of Wireless LANs. Depending on the model every wireless interface can build up to eight different wireless networks ("multi SSID").
- A DMZ interface enables for some models a 'demilitarized zone' (DMZ), which is also physically separated within the LAN bridge from other LAN interfaces.
- The LAN bridge provides a protocol filter that enables blocking of dedicated protocols on the LAN. Additionally, single LAN interfaces can be separated by the "isolated mode". Due to VLAN functions, virtual LANs may be installed in the LAN bridge, which permit the operating of several logical networks on a physical cabling.
- Applications can communicate with different IP modules (NetBIOS, DNS, DHCP server, RADIUS, RIP, NTP, SNMP, SYSLOG, SMTP) either via the IP router, or directly via the LAN bridge.
- The functions "IP masquerading" and "N:N mapping" provide suitable IP address translations between private and public IP ranges, or also between multiple private networks.
- Provided according authorization, direct access to the configuration and management services of the devices (WEBconfig, Telnet, TFTP) is provided from the LAN and also from the WAN side. These services are protected by

2 System design

filters and login barring, but do not require any processing by the firewall. Nevertheless, a direct access from WAN to LAN (or vice versa) using the internal services as a bypass for the firewall is not possible.

- The IPX router and the LANCAPI access on the WAN side only the ISDN interface. Both modules are independent from the firewall, which controls only data traffic through the IP router.
- The VPN services (including PPTP) enable data encryption in the Internet and thereby enable virtual private networks over public data connections.
- Depending on the specific model, either xDSL/Cable, ADSL or ISDN are available as different WAN interfaces.
- The DSLoL interface (DSL over LAN) is no physical WAN interface, but more a "virtual WAN interface". With appropriate LCOS settings, it is possible to use on some models a LAN interface as an additional xDSL/Cable interface.

3 Configuration and management

This section will show you the methods and ways you can use to access the device and specify further settings. You will find descriptions on the following topics:

- Configuration tools
- Monitoring and diagnosis functions of the device and software
- Backup and restoration of entire configurations
- Installation of new firmware in the device

3.1 Configuration tools and approaches

LANCOM are flexible devices that support a variety of tools (i.e. software) and approaches (in the form of communication options) for their configuration. First, a look at the approaches.

You can connect to an LANCOM with three different access methods (according to the connections available).

- Through the connected network (LAN as well as WAN—inband)
- Through the configuration interface (config interface) on the rear of the router (also known as outband)
- Remote configuration via ISDN access or modem (analog or GSM with LANCOM Modem Adapter Kit)

3.1.1 What is the difference between these three possibilities?

On the one hand, the availability: Configuration via outband is always available. Inband configuration is not possible, however, in the event of a network fault. Remote configuration is also dependent on an ISDN connection.

On the other hand, whether or not you will need additional hardware and software: The inband configuration requires one of the computers already available in the LAN or WAN, as well as only one suitable software, such as LANconfig or WEBconfig (see following section). In addition to the configuration software, the outband configuration also requires a computer with a serial port. The preconditions are most extensive for ISDN remote configuration: In addition to an ISDN capable LANCOM, an ISDN card is needed in the configuration PC or alternatively, access via LANCAPI to an additional LANCOM that is ISDN capable.

3.2 Configuration software

Situations in which the device is configured vary—as do the personal requirements and preferences of the person doing the configuration. LANCOM routers thus feature a broad selection of configuration software:

- **LANconfig**—nearly all parameters of the LANCOM can be set quickly and with ease using this menu-based application. Outband, inband and remote configuration are supported, even for multiple devices simultaneously.
- **WEBconfig**—this software is permanently installed in the router. All that is required on the workstation used for the configuration is a web browser. WEBconfig is thus independent of operating systems. Inband and remote configuration are supported.
- **SNMP**—device-independent programs for the management of IP networks are generally based on the SNMP protocol. It is possible to access the LANCOM inband and via remote configuration using SNMP.
- **Terminal program, Telnet**—an LANCOM can be configured with a terminal program via the config interface (e.g. HyperTerminal) or within an IP network (e.g. Telnet).
- **TFTP**—the file transfer protocol TFTP can also be used within IP networks (inband and remote configuration).

The following table shows, how you can use the configuration:

Configuration software	LAN, WAN, WLAN (Inband)	Config Interface (Outband)	ISDN remote configuration	Analog dial-in (with LANCOM Modem Adapter Kit)
LANconfig	Yes	Yes	Yes	Yes
WEBconfig	Yes	No	Yes	Yes
SNMP	Yes	No	Yes	Yes
Terminal program	No	Yes	No	No
Telnet	Yes	No	No	No
TFTP	Yes	No	Yes	Yes

! Please note that all procedures access the same configuration data. For example, if you change the settings in LANconfig, this will also have a direct effect on the values under WEBconfig and Telnet.

3.3 Searching and configuring devices

! Always switch on your device first before starting the PC for configuration.

A Router or an Access Point can be configured in the following ways (provided that the model is equipped with the according interface):

- Via the local network (LAN) .
- Via the wireless network (WLAN) , if the WLAN encryption (e.g. WEP) of a device with a wireless interface and in the configuration PC has been adjusted correctly and/or has been deactivated.
- Via the serial configuration interface .
- Via a ISDN connection

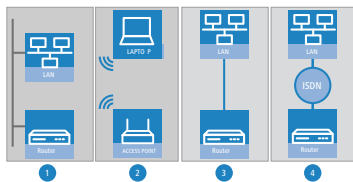

3.4 Configuration with LANconfig

3.4.1 Starting LANconfig

Start LANconfig by, for example, using the Windows Start menu: **Start / Programme / LANCOM / LANconfig**. LANconfig will now automatically search for devices on the local network. It will automatically launch the setup wizard if a device which has not yet been configured is found on the local area network LANconfig.

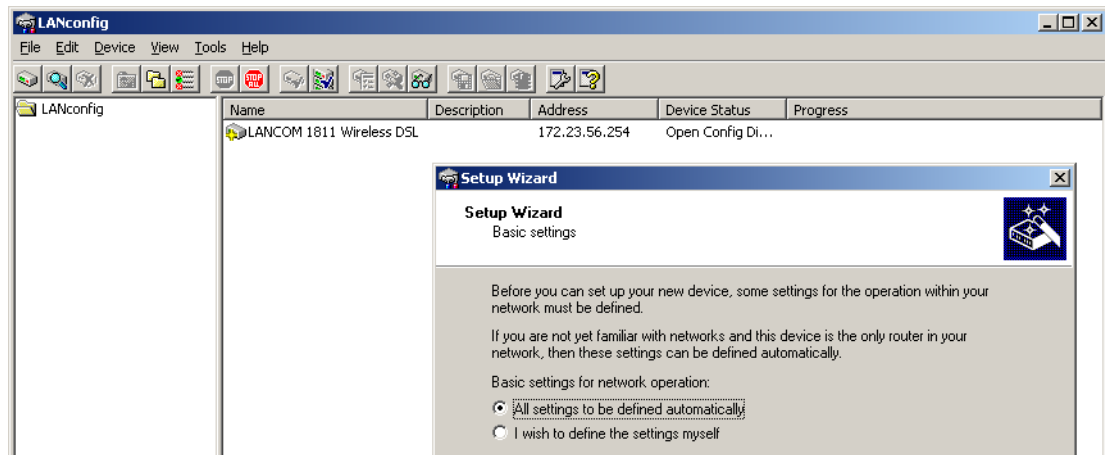

⚠ If the firewall is activated the LANconfig might not be able to find the new device in the LAN. In this occasion deactivate the firewall whilst the configuration.

Your LANCOM device is equipped with an extensive firewall and protects your computer even if no further firewall is active.

Find new devices

Click on the **Find** button or call up the command with **Device E Find** to initiate a search for a new device manually. LANconfig will then prompt for a location to search. You will only need to specify the local area network if using the inband solution, and then you're off.

3 Configuration and management

Once LANconfig has finished its search, it displays a list of all the devices it has found, together with their names and, perhaps a description, the IP address and its status.

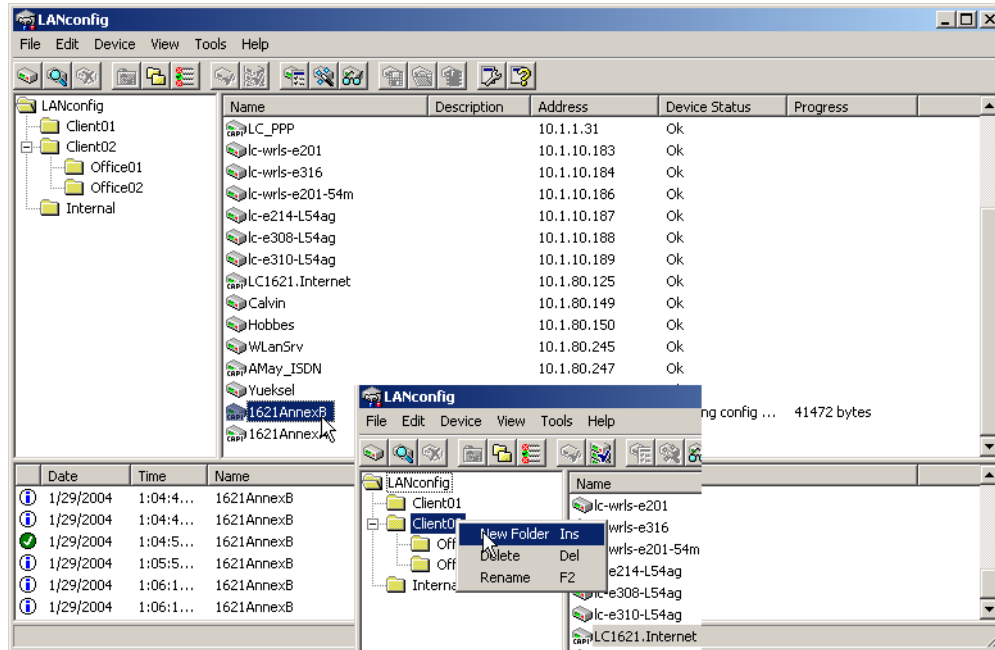

The expanded range of functions for professionals

Two different display options can be selected for configuring the devices with LANconfig:

- The 'Simple configuration display' mode only shows the settings required under normal circumstances.
- The 'Complete configuration display' mode shows all available configuration options. Some of them should only be modified by experienced users.

Select the display mode in the **View / Options** menu.

Double-clicking the entry for the highlighted device and then clicking the **Configure** button or the **Device/ Configure** option reads the device's current settings and displays the 'General' configuration selection.

The integrated Help function

The remainder of the program's operation is self-explanatory or you can use the online help. You can click on the 'Help' button top right in any window or right-click on an unclear term at any time to call up context-sensitive help.

Management of multiple devices

LANconfig supports multi device remote management. Simply select the desired devices, and LANconfig performs all actions for all selected devices then, one after the other. The only requirement: The devices must be of the same type.

In order to support an easy management, the devices can be grouped together. Therefore, ensure to enable 'Folder Tree' in the View menu, and group the devices by 'drag an drop' into the desired folders.

- ! LANconfig shows only those parameters that are suitable for multi device configuration when more than one device is selected, e.g. MAC Access Control Lists for all LANCOM Access Points.

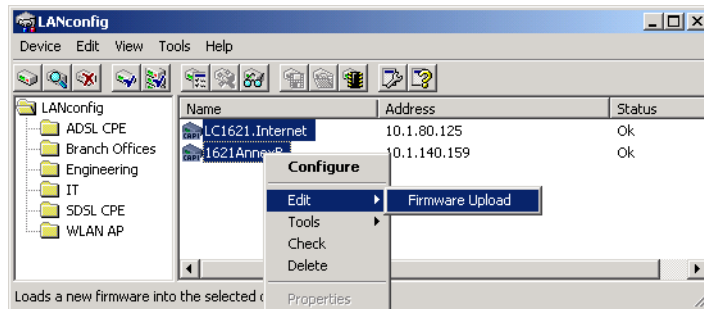

3.4.2 Switch graphical user interface language

The language for the LANconfig, LANmonitor or WLANmonitor graphical user interface can be set to 'German' or 'English'.

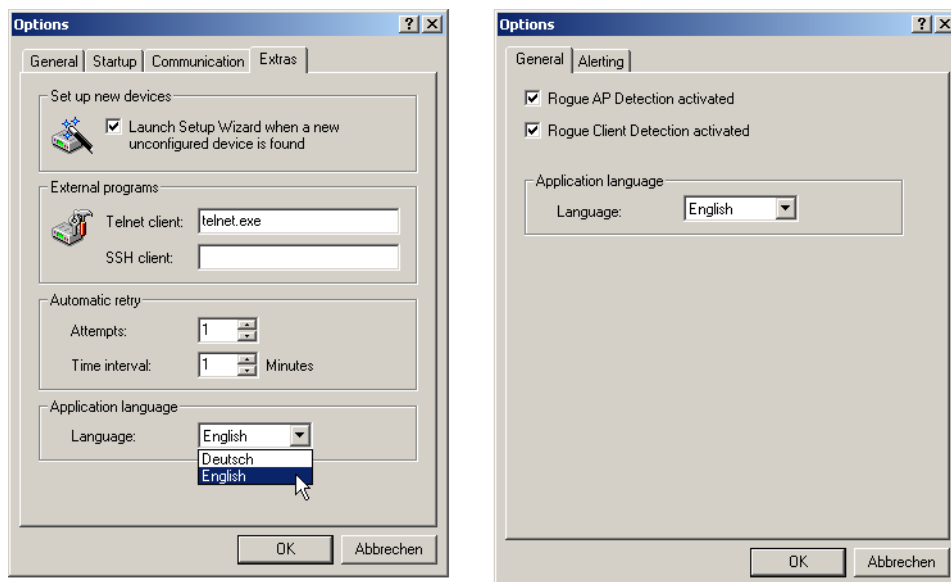

LANconfig: Tools / Options / Extras

LANmonitor and WLANmonitor: Tools / Options / General

3.4.3 Project management with LANconfig

LANconfig facilitates the configuration of various devices within a project with a range of functions that can be run on several devices at once. If the list in LANconfig contains multiple devices, just click on the device of your choice with the right mouse key to open a context menu offering the following actions:

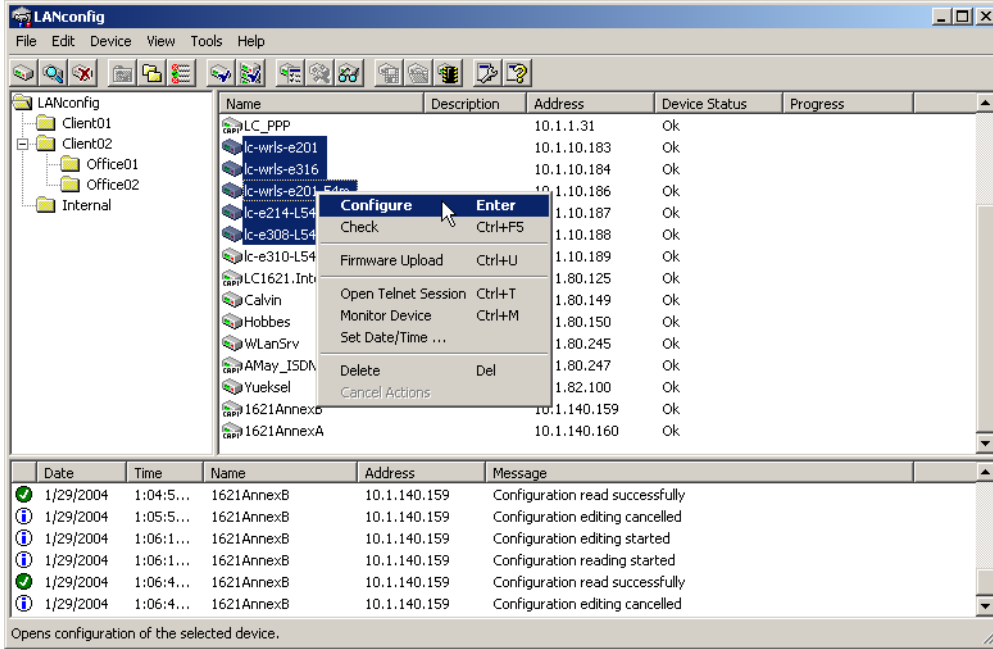

- Configure: Opens up the LANconfig configuration dialog for the selected device
- Check: Checks if the selected device can be contacted
- Firmware upload: Uploads firmware simultaneously to all selected devices
- Apply Script: Applies a configuration script to all selected devices

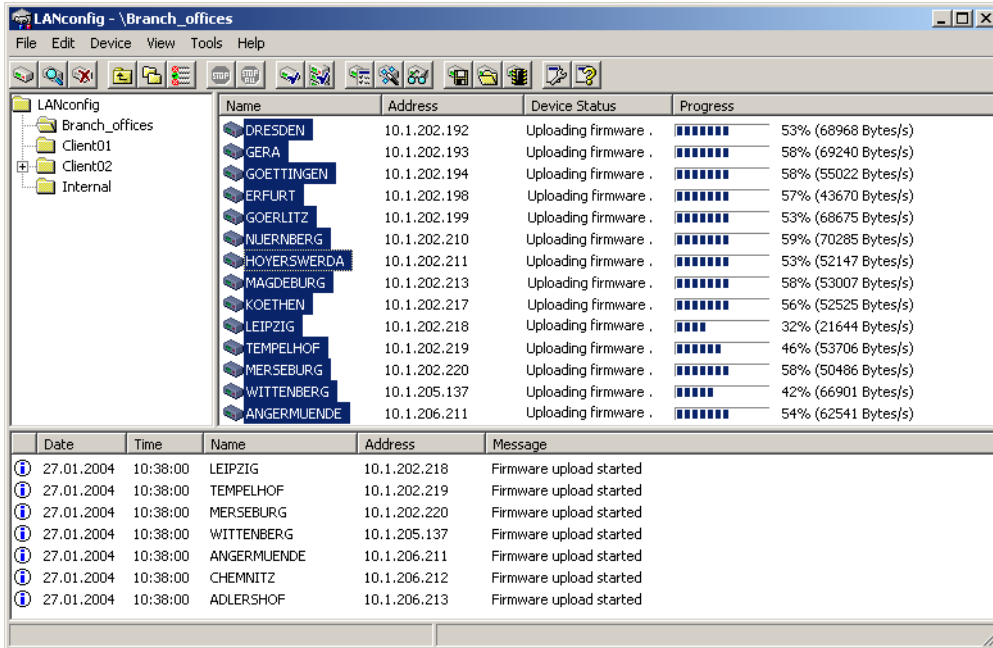

- Open Telnet session: Opens up multiple DOS windows and sets up a Telnet connection to each device
- Monitor device: Starts LANmonitor for the surveillance of the selected devices

- Set date/time: Sets the same time on all selected devices.

! When setting the time, please observe the functions of the LANCOM as NTP client and NTP server.

- Delete: Deletes the selected devices from the LANconfig list.

3.4.4 User-specific settings for LANconfig

The program settings for LANconfig are saved to the file 'lanconf.ini' located in the program directory when the program is ended. This includes, among others, the displayed devices, directory structure, selected language, etc. When the program is started, LANconfig reads this ini file and restores the previous status of the software. To save the ini file, the user needs a write authorization to the program directory.

As an alternative to the .ini file in the program directory, the program settings can be read from another source. The current user's user directory can be chosen, or indeed any other lanconf.ini from any location:

- By selecting the user directory, users can save their personal settings even if they don't have a write authorization for the program directory.
- Selecting an alternative storage location can be used, for example, to transfer program settings to any other LANconfig installation, or to save the program settings to a central location in the network for use by multiple users.

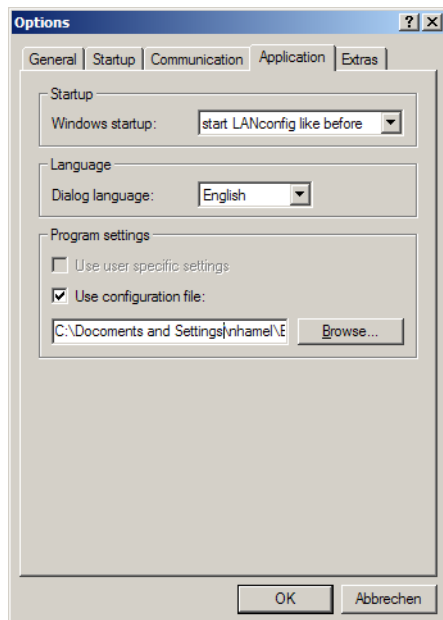

LANconfig: Options / Application

- Use user-specific settings

Activates the use of the lanconf.ini file in the current user's directory `.. \User\Application Files\LANCOM\LANconfig`.

With this option activated, changes to the program settings are saved to this ini file.

- Possible values: On/off
- Default: Off

! If this option is activated in parallel with the 'Use configuration file' option, then the file selected here will be used when the program starts and changes made to the program settings are stored to it.

- Use configuration file

Activates the usage of the lanconf.ini from the given directory.

With this option activated, changes to the program settings are saved to the ini file selected here.

3 Configuration and management

- Possible values: On/off and selection of the settings file
- Default: Off

! The file you select must be a valid LANconfig settings file.

! If neither of the two options is activated, the ini file from the program directory will be used instead.

3.4.5 Customizing the toolbar

To customize the toolbar, select the following options in LANconfig under **View / Toolbar**:

- Standard buttons: Hides/displays the buttons.
- Large icons: Shows a larger view of the icons.
- Show text: Text describing the action is displayed under each icon.

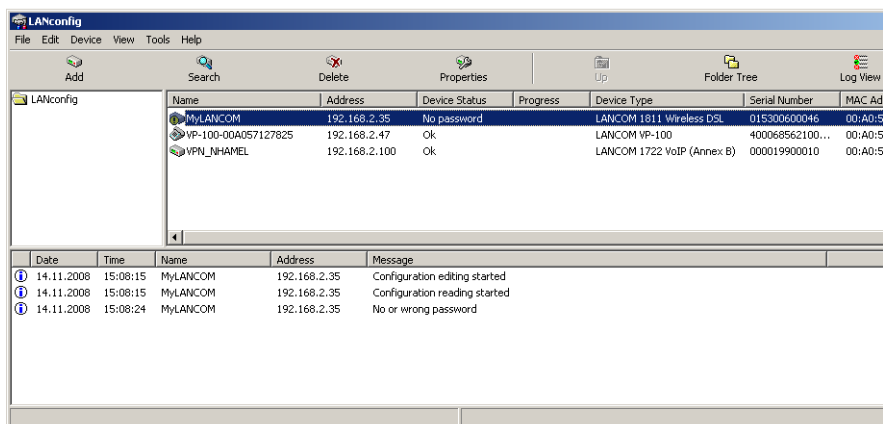

- Customize: Opens up a dialog enabling the displayed icons to be selected. A separator can be inserted between groups of icons. The order of the icons can also be changed.

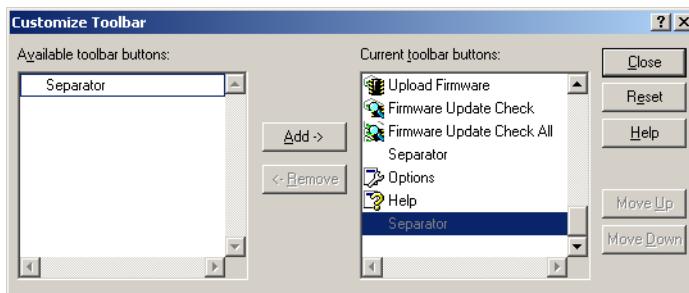

- Reset: Resets the settings for the toolbar to the default values.

3.4.6 Automatic backup of configuration with LANconfig

LANconfig can automatically save backups of the current configuration prior to changes in firmware or configuration. Global settings to be used for all devices are available under **Tools / Options / Backup**. Additionally, special backup settings can be defined for individual devices. To access them, right-click the appropriate device and select entry **Properties / Backup** from the context menu.

Select the following options here:

- Are the global or the device-specific backup settings for this device to be used (in device-specific dialogue only)?
- The event prior to which the configuration is to be saved (firmware upload, configuration change or script execution).
- In which format the configuration is to be saved (configuration file, script - possibly with options).
- In which directory the configuration is to be saved.
- How the file name of the backup file is to be structured. Placeholders can be used for device information (IP address, hardware type, etc.) and time information. Please refer to the online help function for further information on placeholders.

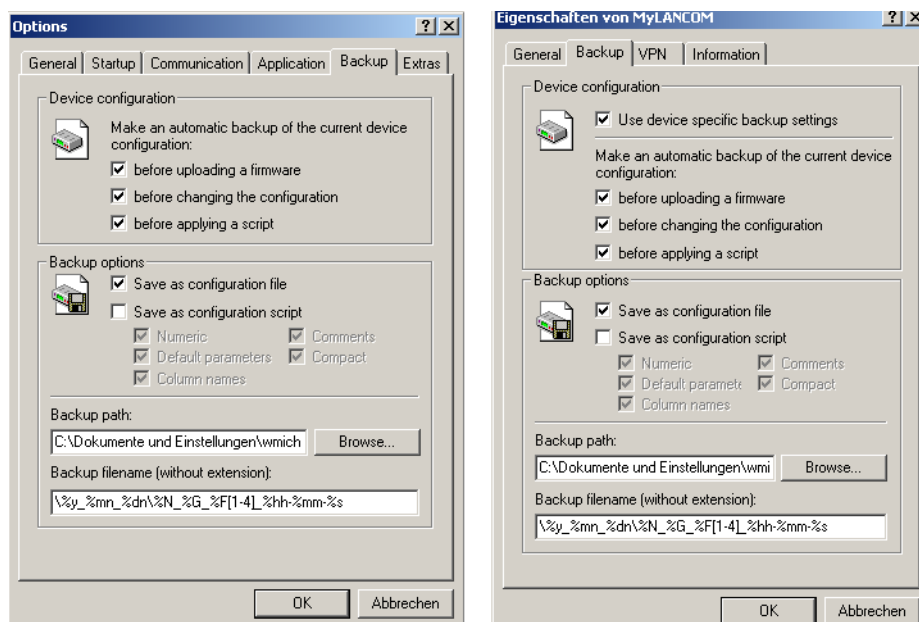

3.4.7 Directory structure

LANconfig uses a directory structure for a clear overview when managing multiple devices. Folders dedicated to projects or customers can be set up to organize the relevant devices:

- Create a new folder by clicking on the parent directory with the right mouse key and selecting "New Folder" from the context menu.
- Just use the mouse to drag and drop the devices into the appropriate folder. Devices can also be moved from one folder to another in this way.

! The arrangement of devices in folders effects only the display of the devices within LANconfig. The organization of the folders has no influence on the configuration of the devices.

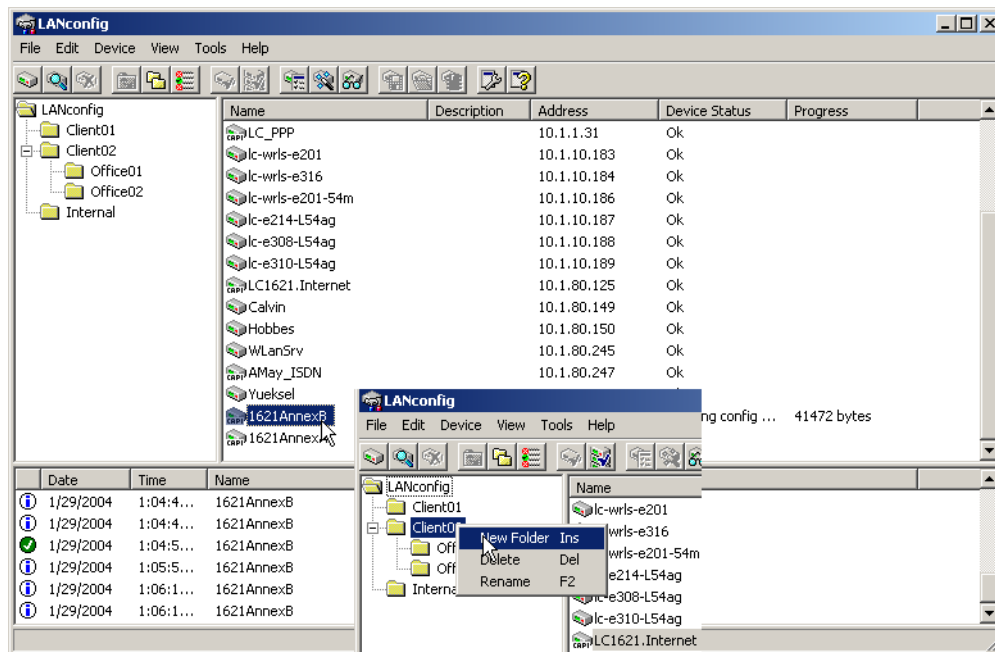

! The directory structure in the left margin of the LANconfig window can be switched on and off with the **F6** function key or by using the menu **View / Folder Tree**.

3.4.8 Better overview in LANconfig with more columns

Even for large-scale projects, a better overview and quicker orientation are facilitated in LANconfig by the columns featuring device-related details that can be displayed or concealed according to your needs. Simply click on the column header with the right-hand mouse button and use **Select columns**. The menu item **Arrange icons** allows you to sort the items as you prefer.

The following details can be displayed in the various columns:

- Device name
- Description
- Address
- Device status
- Progress
- Device type
- Hardware release
- Serial number
- MAC address
- Firmware version (active)
- FirmSAFE
- 1. Image version

2. Image version

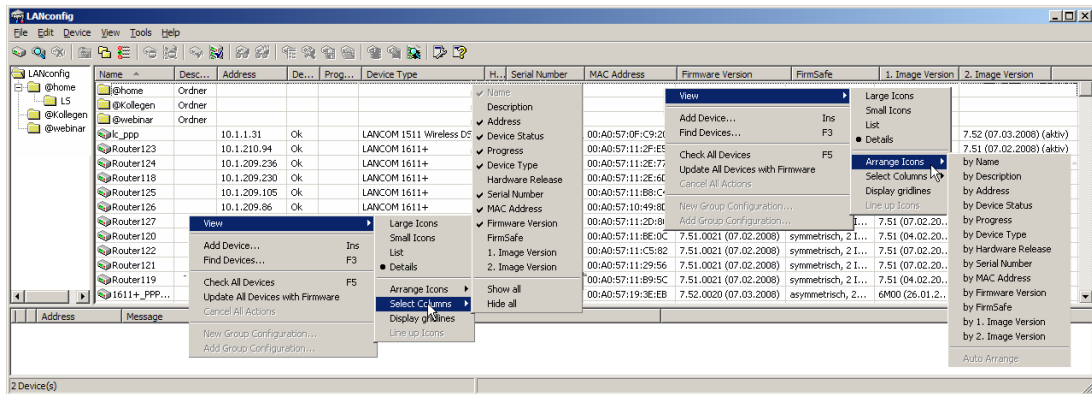

3.4.9 Multithreading

The management of larger projects can be aided by simultaneously opening up configuration windows for multiple devices to compare similarities and differences. LANconfig allows multiple configuration dialogs to be opened at the

3 Configuration and management

same time ("multithreading"). After opening the configuration for a device, simply open up further configurations from the device list in LANconfig. All of the configurations can be processed in parallel.

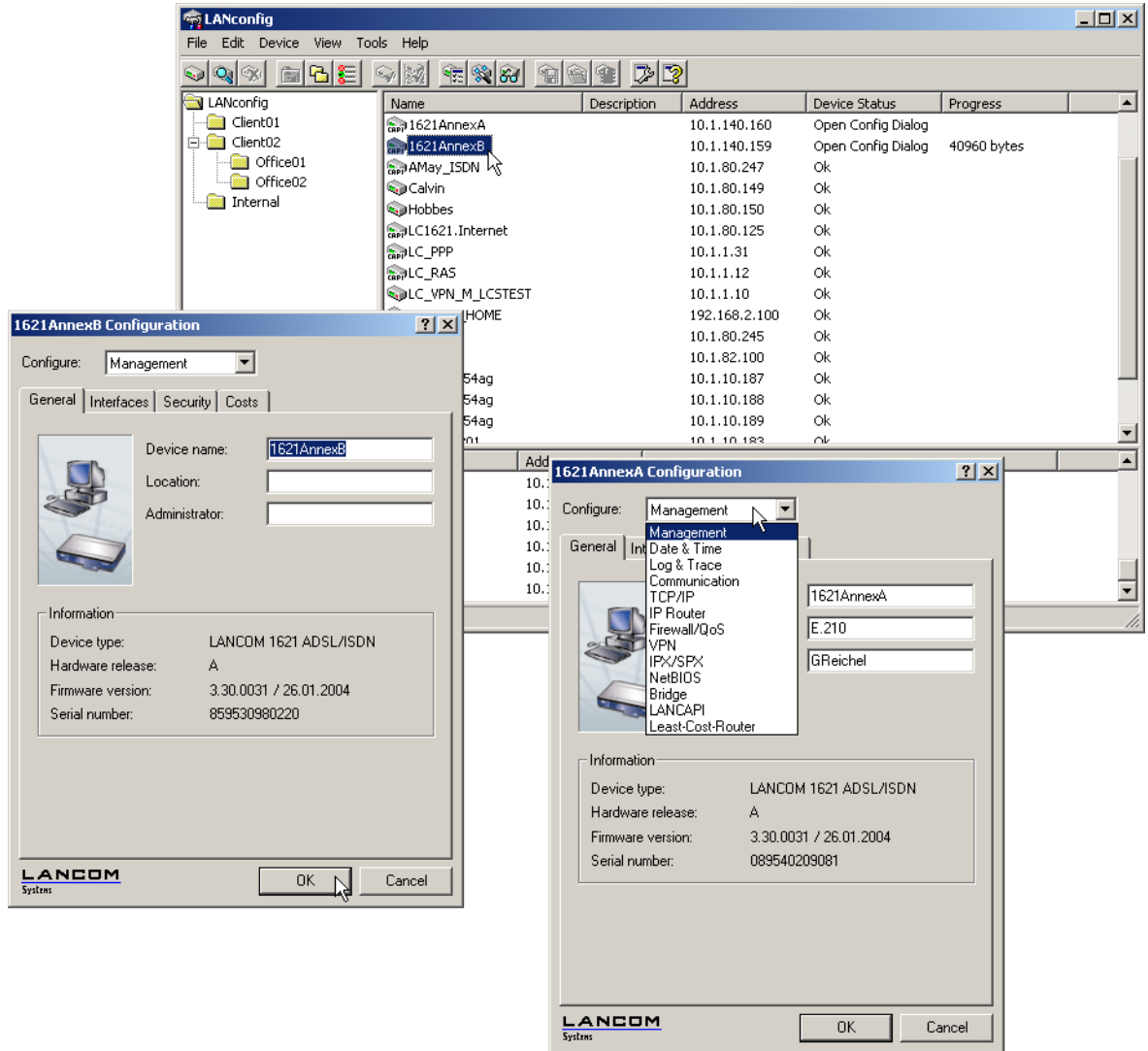

! "Cut and paste" can be used to transfer content between the configuration windows via the Windows clipboard.

Multithreading allows changes to both the internal configurations of the available devices and to the configuration files. Each configuration is written separately to the file and to the device when the dialog is closed.

3.4.10 Manual and automatic searches for firmware updates

To make the update of LANCOM devices with new firmware as convenient as possible, the firmware files for the various LANCOM models and LCOS versions are, ideally, saved to a central archive directory. The search for new versions of the firmware in this directory can either be initiated manually or automatically after starting LANconfig.

Automatic search for firmware updates

The directory where LANconfig is to search for the updates is set under **Tools / Options / Extras**. It is also possible to set up LANconfig to search the firmware archive and to check if any of the devices found require an update. With this option activated, starting LANconfig automatically displays all of the devices for which new updates are available.

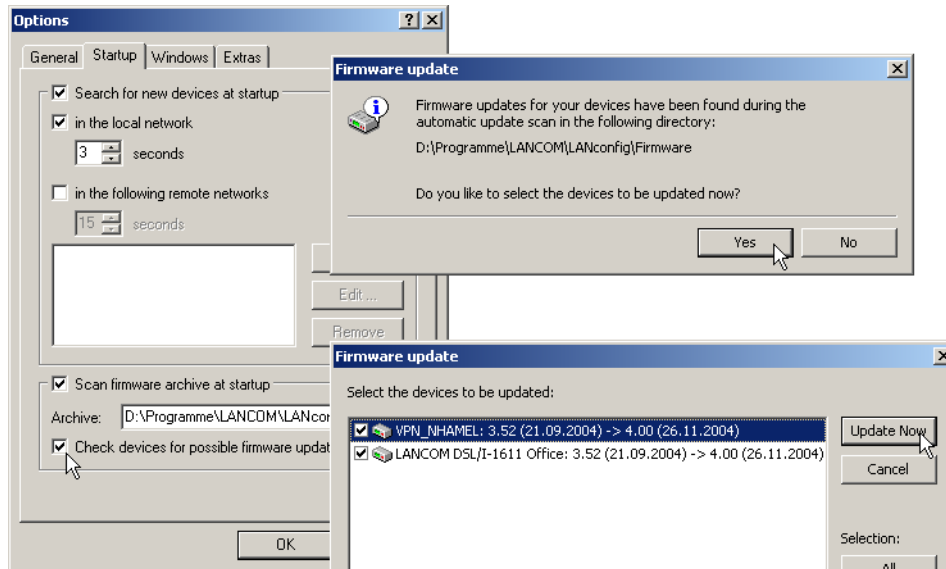

Manual search for firmware updates

To search manually for firmware updates, click with the right-hand mouse key on a device marked in the list and select the following point from the context menu: **Firmware management / Check for firmware update**. If you wish to update several devices simultaneously, the entry **Check for firmware updates** is displayed directly in the context menu.

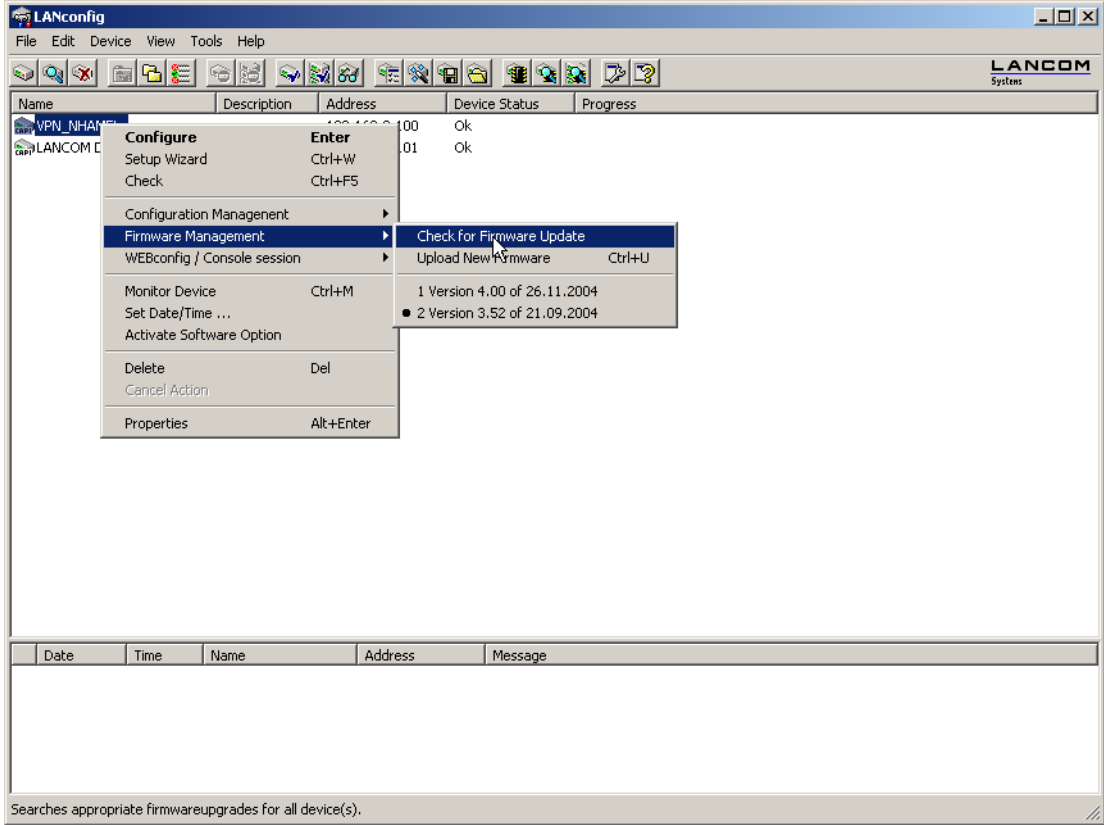

View a full list of all firmware versions

If your search in the archive did not reveal a new firmware version, you can alternatively view a full list of all of the firmware files that have been found. You can, for example, switch back to an older version. LANconfig displays all versions found for the marked devices, including the version currently active in each device. For each device, you can select precisely one firmware version that will then be uploaded onto the device.

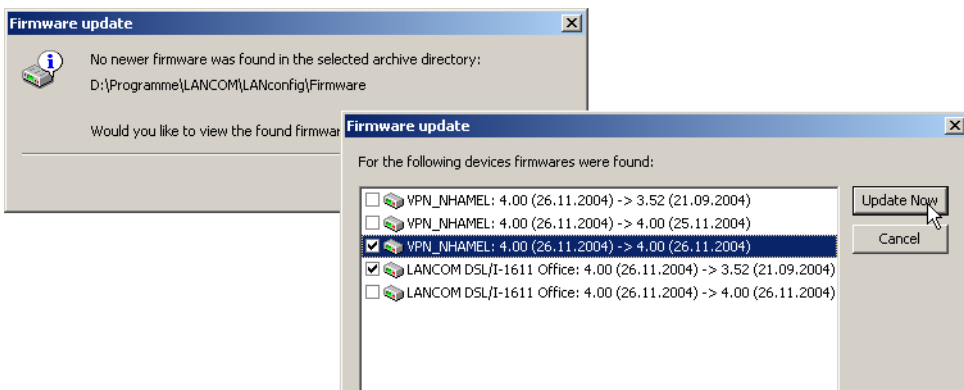

3.4.11 Password protection for SNMP read-only access.

The read-only access to a LANCOM device via SNMP—for example with LANmonitor--can be password protected. This uses the same user data as with access to LANconfig. Password protection of SNMP access means that the user data must be entered before information about the device status, etc. can be accessed over SNMP.

User information can be entered in LANmonitor separately for each device. To do this, click with the right-hand mouse key on the required device, select the **Options** point from the context menu and enter your user data.

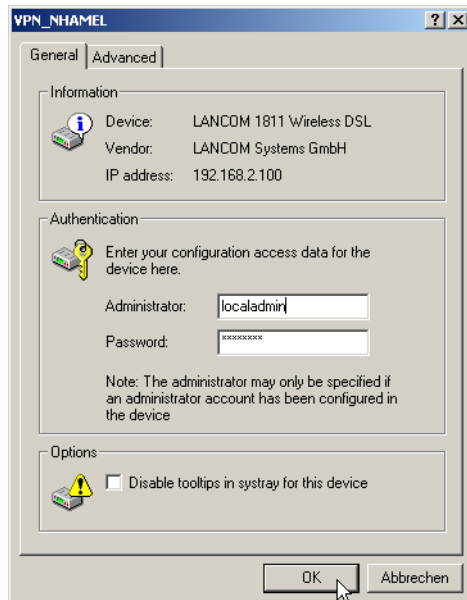

Access rights in LANmonitor depend on the rights possessed by the user:

- A supervisor has full access to the information in LANmonitor and can execute actions such as closing a connection, among others.
- A local administrator also has full access to the information in LANmonitor and can execute actions such as closing a connection, among others.
- A user with read-only rights can view the information in LANmonitor but cannot take any actions such as closing a connection.

- A user without rights has no SNMP access to the device's information.

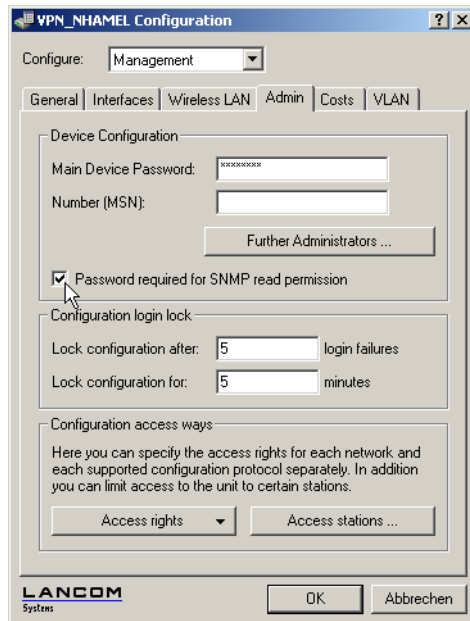

LANconfig: Management/ General

WEBconfig: LCOS menu tree / Setup / Config modul / Password-required-for-SNMP-read-access

3.4.12 Device-specific settings for communications protocols

With LANconfig, all device actions are conducted using the TFTP protocol. Since this protocol has disadvantages compared to other protocols when transmitting large volumes of data, the protocols HTTPS and HTTP can also be used as alternatives.

The use of the protocols can be set either globally for all devices managed by a LANconfig or specifically for each individual device. The global settings overwrite the specific settings here – therefore, in the specific device settings, only the settings allowed in the global configuration can take effect.

Configuration of the global communication settings

When setting up the communications protocols, one must differentiate between the protocol that is used solely for checking the device and for other operations such as a firmware upload, etc.:

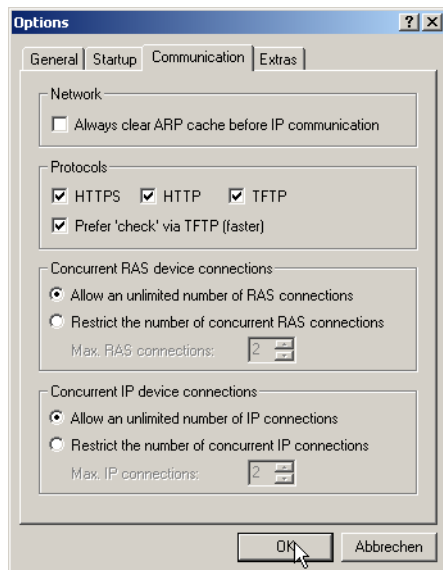

LANconfig: Tools / Options / Communication

- HTTPS, HTTP, TFTP

When this is selected, the individual protocols are enabled for the operations firmware upload, configuration up/download, and script up/download. In these operations, LANconfig attempts to use these protocols in the order HTTPS, HTTP and TFTP. If the transfer fails when using a selected protocol, then the next protocol is automatically attempted.

- Prefer checks via TFTP

When checking the devices, only small amounts of data are transferred with the system information. As such, device checks could be performed using the TFTP protocol, particularly in the LAN. When this option is activated, the TFTP protocol is used to check the device first, regardless of the previously set communications protocols. If the check via TFTP fails, then the protocols HTTPS and HTTP are attempted in that order.

! The device-specific settings are subordinate to the global communications settings. This allows, for example, the use of a protocol to be restricted centrally.

Configuration of the specific communication settings

For configuring the specific communications settings, the properties dialog of a device is opened via the context menu (right-click on mouse):

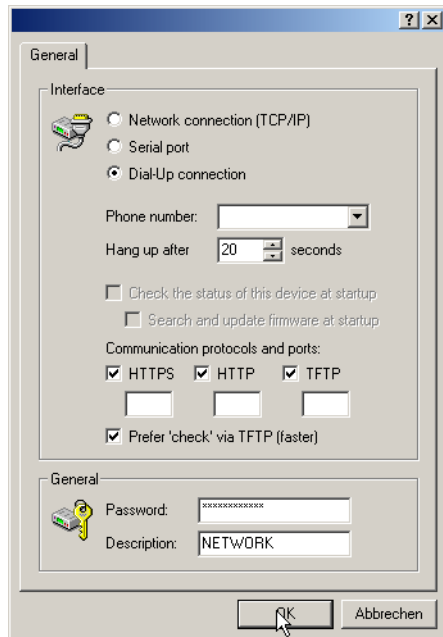

- HTTPS, HTTP, TFTP

Select the communications protocols as described in the global settings:

In the fields under the protocols, the port to be used can be entered using the following default values:

- HTTPS: 443
- HTTP: 80
- TFTP: 69
- Prefer checks via TFTP

Preferred checking via TFTP as described in the global settings.

For all specific communications settings, the global settings are considered to be superordinate. A protocol can therefore only be used for operating a device when it is also activated in the global settings.

3.4.13 LANconfig behavior at Windows startup

LANconfig can be automatically started when the operating system starts.

Configuring the behavior of LANconfig at startup

The following parameters are used to configure the startup behavior of LANconfig:

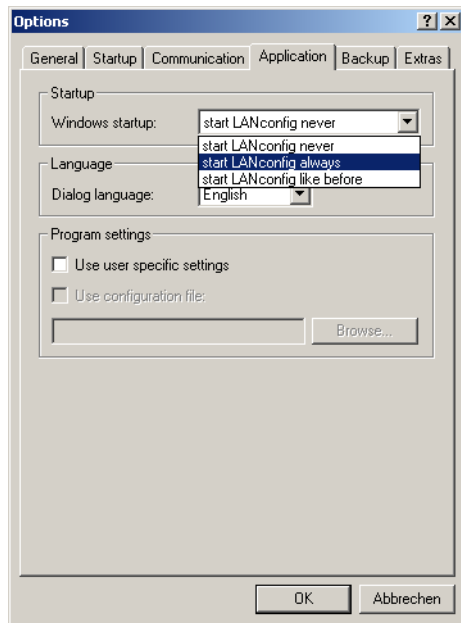

LANconfig: Options / Extras / Application

- Windows system startup
 - Start LANconfig never: LANconfig does not start automatically with the operating system, and it has to be started manually.
 - Start LANconfig always: LANconfig always starts automatically after Windows starts successfully.
 - Start LANconfig like last time: LANconfig starts in the program in the same status as when Windows was shut down the last time: If LANconfig was active then it will be started again; if inactive, LANconfig will not be automatically restarted.

ⓘ When changing to a setting that enables LANconfig to be started automatically, a change is made to the operating system's registry. Personal firewalls on the computer or the operating system itself (Windows XP or Windows Vista™) may interpret this change as an attack and may issue a warning or even prevent the entry from being made. In order for LANconfig's startup behavior to be controlled as desired, you can ignore these warnings and allow the changes to be made.

3.4.14 Choice of Wizard or configuration dialog

You can define how LANconfig reacts when an entry in the list of devices is double-clicked, i.e. whether a Setup Wizard or the dialog for manually editing the configuration appears.

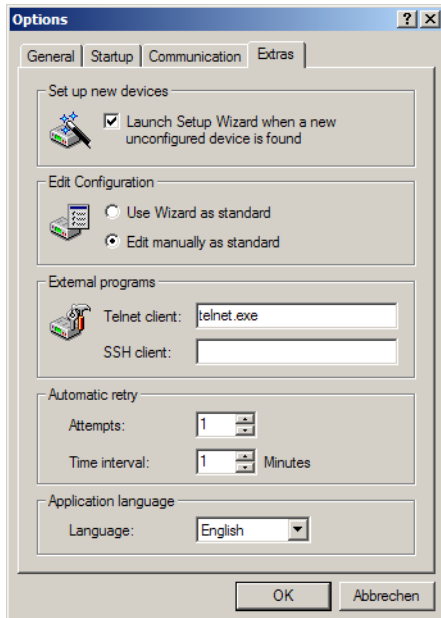

The standard behavior of LANconfig can be set under:

LANconfig: Tools / Options / Extras

- Editing the configuration

- Use Wizard as standard: Double-clicking on a device entry in LANconfig will open up a dialog offering a choice of Wizards. As an alternative, the option 'Manually edit the configuration' can be selected here.

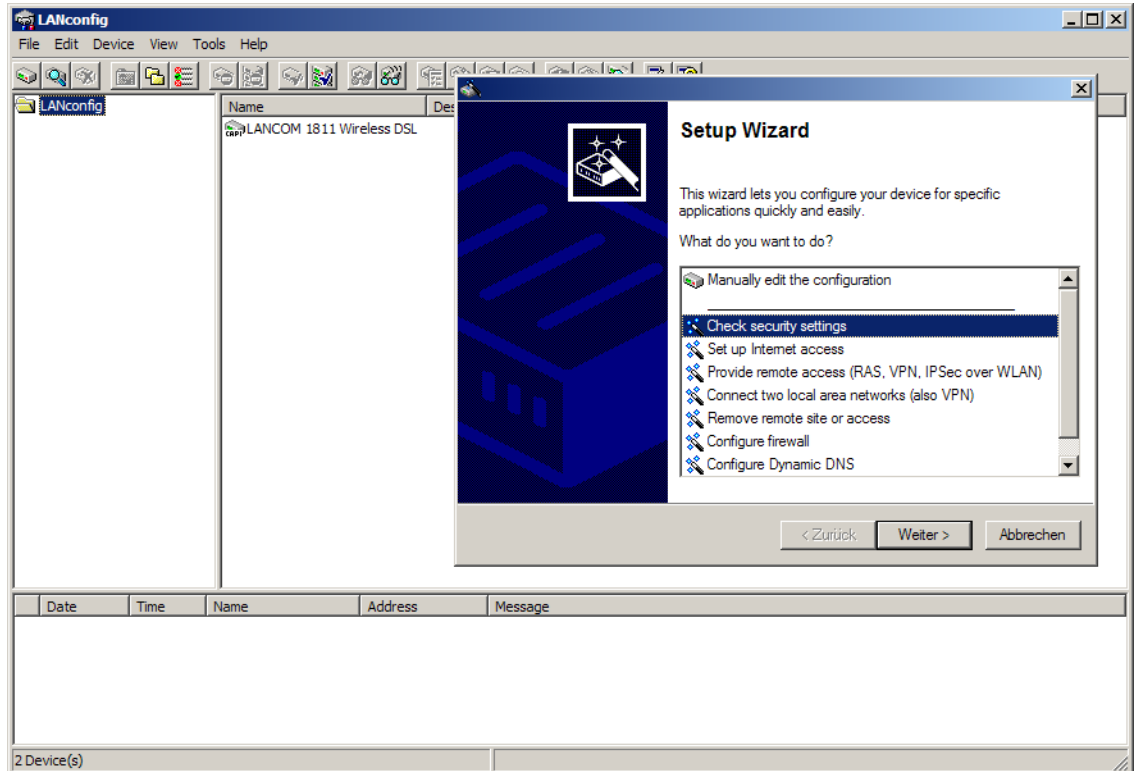

- Edit manually as standard: Double-clicking on a device entry in LANconfig will open up a dialog for editing the configuration manually.

3.4.15 WLAN configuration with the wizards in LANconfig

Highly convenient installation wizards are available to help you with the configuration of LANCOM Access Points for your wireless LAN.

The settings include the general shared parameters and also the individual settings for one or more logical wireless LAN networks (WLAN radio cells or SSIDs).

1. Mark your LANCOM Access Point in the selection window in LANconfig. From the command line, select **Extras / Setup Wizard**.

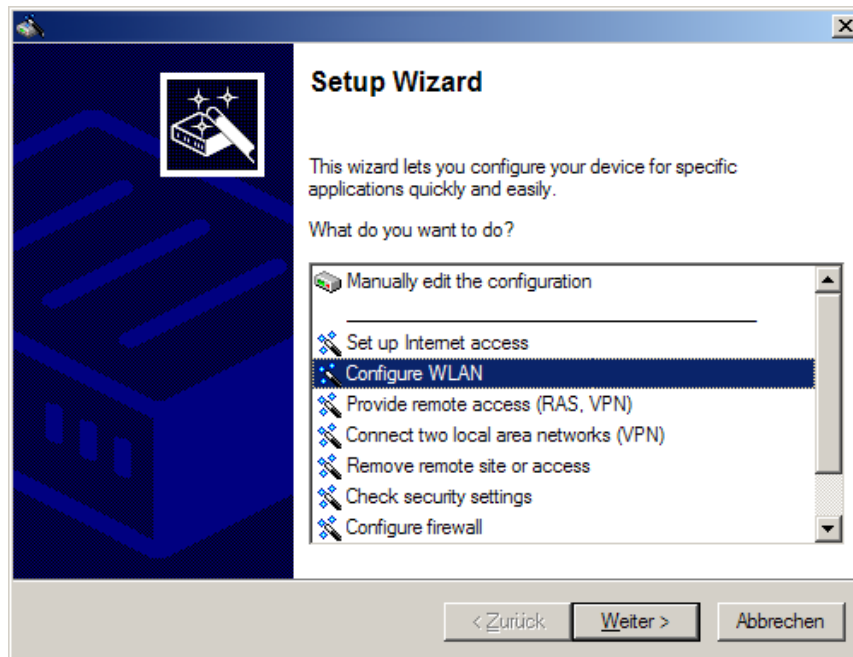

1. In the selection menu, select the Setup Wizard, **Configure WLAN interface** and confirm the selection with **Continue**.
2. Make the settings as requested by the wizard and as described as follows.

Country settings

Regulations for the operation of WLAN cards differ from country to country. The use of some radio channels is prohibited in certain countries. To operate the LANCOM Access Points while observing the regulations in various countries, all physical WLAN interfaces can be set up for the country where they are operated.

WLAN module operation

The WLAN modules can be operated in various operating modes:

- As a base station (Access Point mode), the device makes the link between WLAN clients and the cabled LAN. Parallel to this, point-to-point connections are possible as well.
- In Managed Mode the Access Points also accept WLAN clients into the network, although the clients then join a WLAN infrastructure that is configured by a central WLAN-Controller. In this operating mode, no further WLAN configuration is necessary as all WLAN parameters are provided by the WLAN-Controller.
- In client mode, the device itself locates the connection to another Access Point and attempts to register with a wireless network. In this case the device serves, for example, to link a cabled network device to an Access Point over a wireless connection. In this operating mode, parallel point-to-point connections are **not** possible.

For further information please refer to section Client Mode.

Physical WLAN settings

Along with the radio channels, the physical WLAN settings can also be used to activate options such as the bundling of WLAN packets (TX Burst), hardware compression, or the use of QoS compliant with 802.11e. You also control the settings for the diversity behavior here.

Logical WLAN networks

Each WLAN module can support up to eight logical WLAN networks for mobile WLAN clients to register with. The following parameters have to be set when configuring a logical WLAN network:

- The network name (SSID)
- Open or closed radio LAN
- Encryption settings
- MAC filter
- Client-bridge operation
- Filter settings

Point-to-point settings

The configuration of P2P connections involves setting not only the operating mode but also the station name that the Access Point can connect to. Also, the role as "Master" or "Slave" is set here.

Along with the settings for the Access Point itself, also to be defined is the remote site that the Access Point can contact via the P2P connection.

For further information please refer to section Point-to-point connections.

3.4.16 Addition(s) to LCOS 8.00

LANconfig configuration tree

As of version 8.00, the two top layers of the configuration menu in LANconfig are permanently visible in a dedicated area as a "configuration tree". This new structure makes it easier to navigate through the program for quick switching between the main configuration areas.

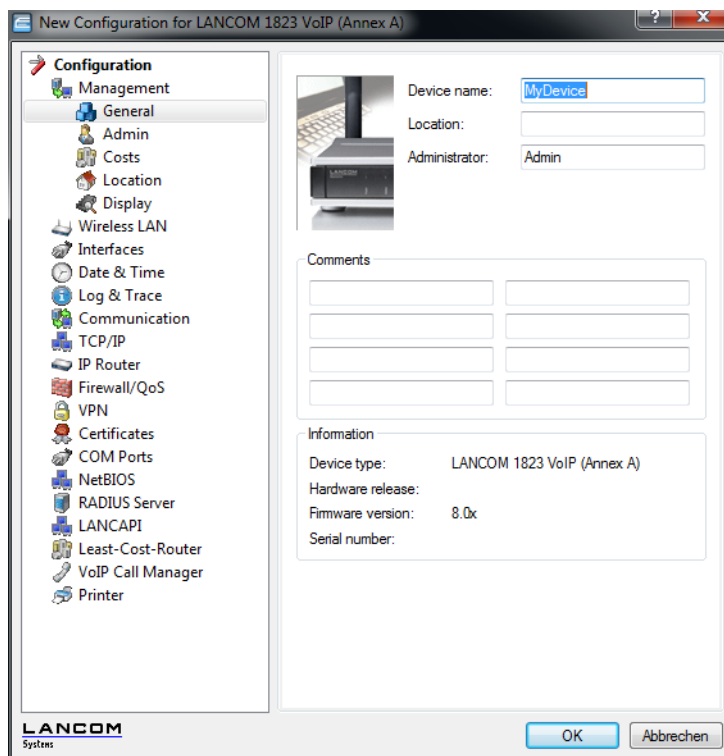

3.4.17 Addition(s) to LCOS 8.50

LANCOM QuickFinder

The configuration dialogs in LANconfig, LANmonitor and WLANmonitor include numerous sections, parameters and their values, as well as tables.

LANCOM QuickFinder in LANconfig

In the main view of LANconfig you will find the LANCOM QuickFinder in the toolbar. Entering a search term in the search window reduces the number of available devices in the list. LANconfig searches through all the values available in the columns in the device list, including any hidden columns. Click on the icon next to the magnifying glass to make the search case sensitive.

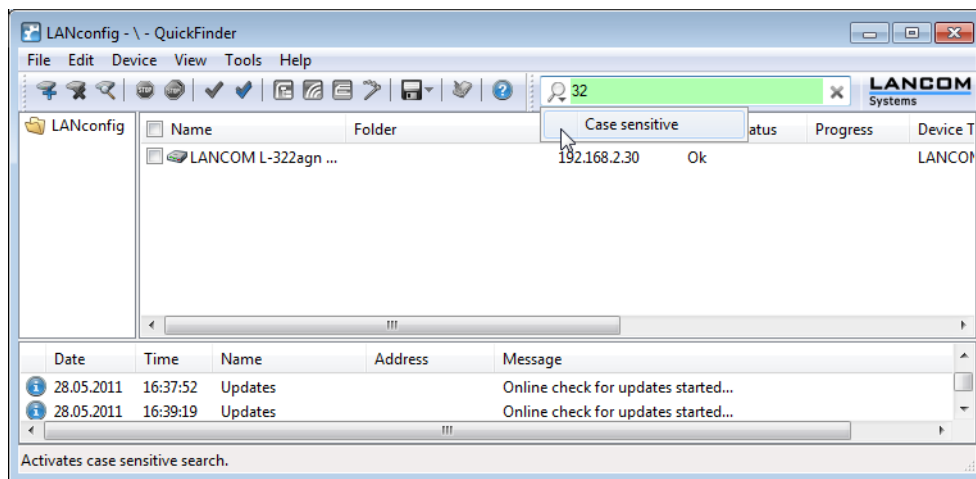

If you are looking for a particular value or term in LANconfig or in the configuration, LANCOM QuickFinder quickly displays all of the locations where the string occurs in the LANconfig dialogs.

1. Start LANconfig.
2. Open the device configuration that you want to search through.
3. In the search box, type the phrase that you are looking for (e.g. 'wlan'). Searching is not case-sensitive. You can enter parts of words or numbers, as well as complete strings. If there are spaces in the search string, then only strings containing the matching spaces will be searched for. The search function does not support wildcards.

The configuration tree in the left pane of LANconfig is now reduced to just those sections that feature the search string:

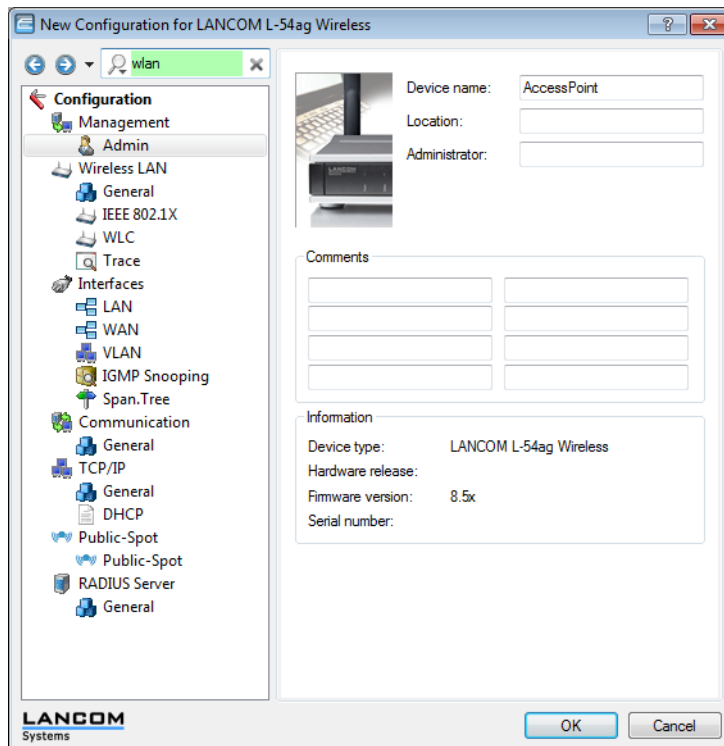

Select an area in the configuration (e.g. 'WLAN/General') to view the relevant search results framed in color in the configuration dialog:

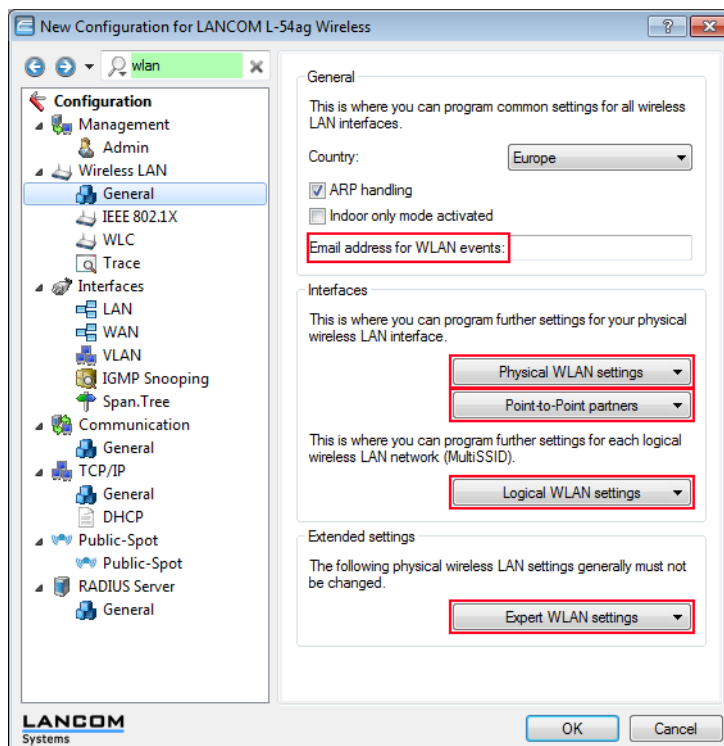

! In LANconfig version 8.50, the search results in the firewall section are not displayed in color.

3 Configuration and management

Use the navigation buttons 'forwards' and 'back' to move between the most recently visited dialogs:

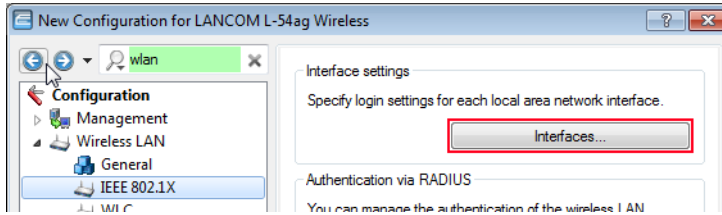

For quick access to the last 10 visited dialogs, click on the arrow to the right of the 'forwards' button:

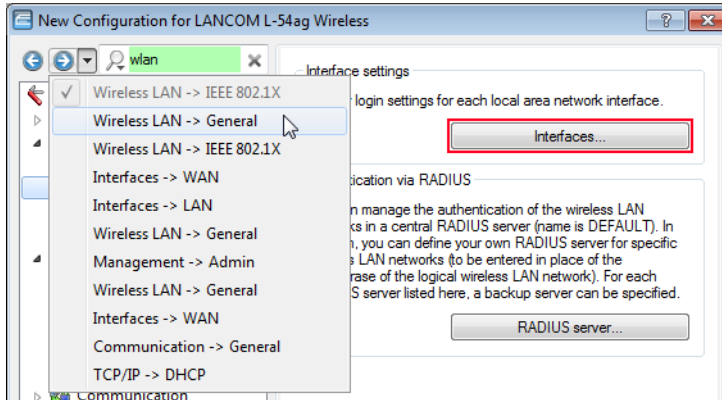

Click on the 'x' to the right of the search box to clear the search and display all entries in the configuration again.

An option to reduce the number of search results is to select the sections where LANconfig should limit the search to. Click on the magnifying glass to the left of the search box and select or deselect the required categories. Here you can also specify whether the search should highlight the results in color, or whether the configuration tree is to be reduced to the relevant dialogs only:

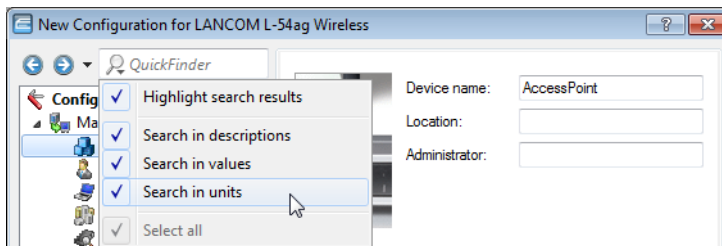

! LANconfig resets the search settings and the list of recent dialogs when the configuration is closed.

LANCOM QuickFinder in LANmonitor

Depending on the application, LANmonitor can display multiple devices with entries containing the searched term. After starting the search LANmonitor initially highlights the first finding. You can move between the search results either by

using the arrow keys to the right of the search window, or by pressing Ctrl+F3 for the next occurrence and Ctrl+Shift+F3 to the previous occurrence.

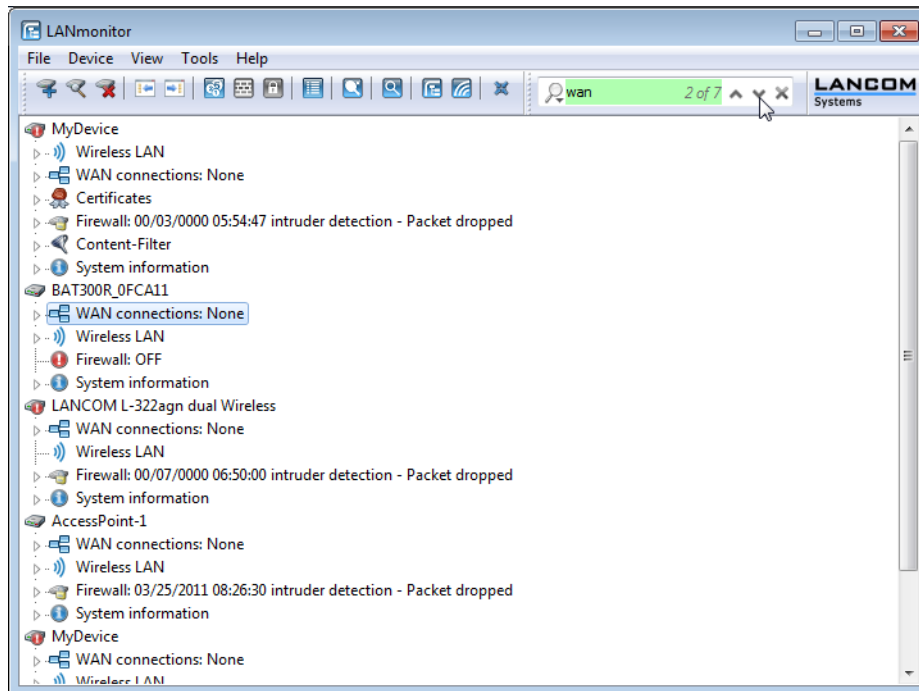

LANCOM QuickFinder in WLANmonitor

WLANmonitor includes access points and WLAN clients. Clicking on the magnifying glass on the left side of the search window opens a context menu to select the type of search. Depending on the application you can search for access points only, clients only, or all entries.

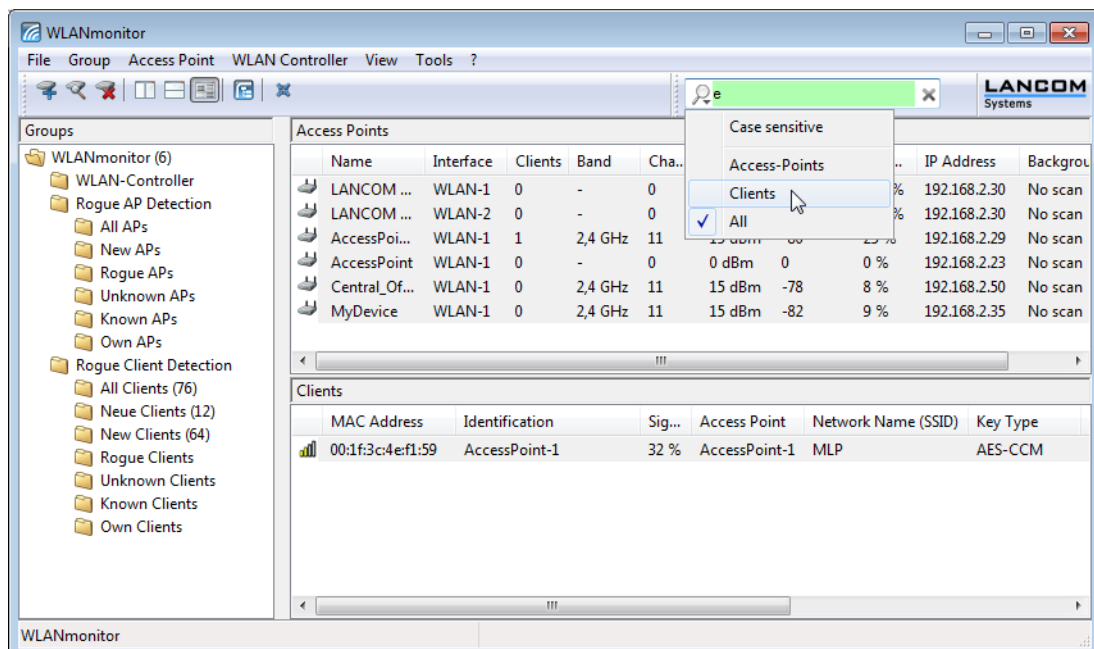

For example, your configuration may contain settings for your Internet provider. To find these you just have to enter the name to find all of the places in the configuration that refer to this provider.

You can search for text from the following areas:

3 Configuration and management

- Entries in the configuration tree
- Names of the sections in each configuration dialog
- Parameters
- Values of the parameters
- Explanatory texts in the dialogs
- Table names
- Column names in tables

To use the search in LANconfig proceed as follows:

LANCOM QuickFinder in LANconfig

In the main view of LANconfig you will find the LANCOM QuickFinder in the toolbar. Entering a search term in the search window reduces the number of available devices in the list. LANconfig searches through all the values available in the columns in the device list, including any hidden columns. Click on the icon next to the magnifying glass to make the search case sensitive.

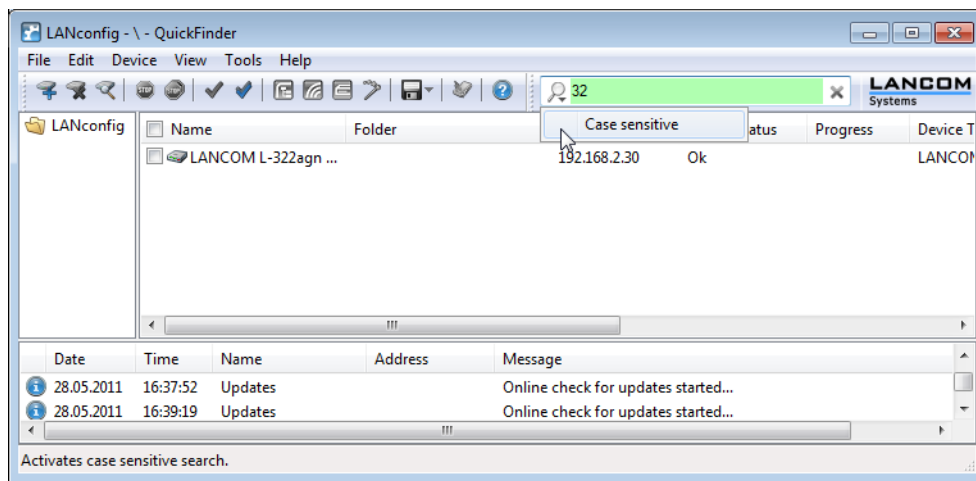

If you are looking for a particular value or term in LANconfig or in the configuration, LANCOM QuickFinder quickly displays all of the locations where the string occurs in the LANconfig dialogs.

1. Start LANconfig.
2. Open the device configuration that you want to search through.
3. In the search box, type the phrase that you are looking for (e.g. 'wlan'). Searching is not case-sensitive. You can enter parts of words or numbers, as well as complete strings. If there are spaces in the search string, then only strings containing the matching spaces will be searched for. The search function does not support wildcards.

The configuration tree in the left pane of LANconfig is now reduced to just those sections that feature the search string:

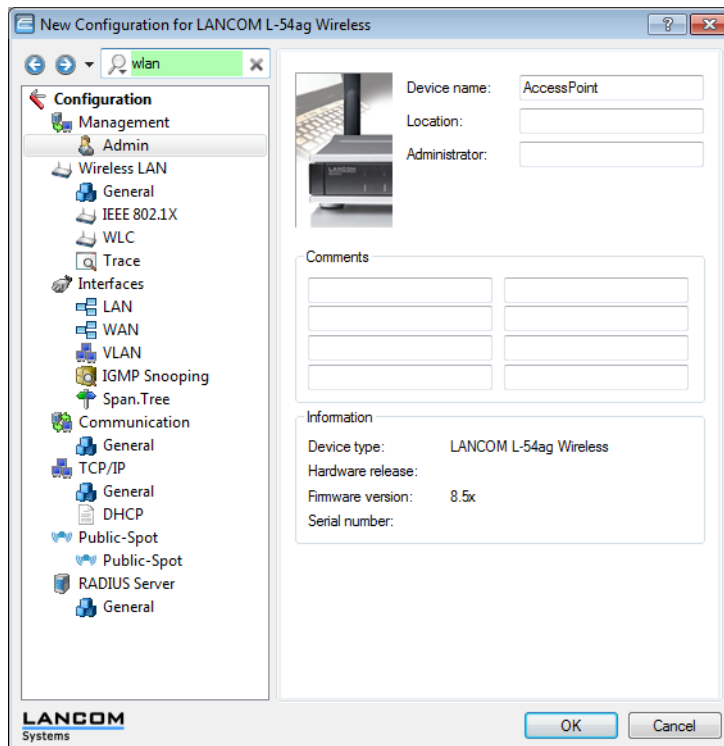

Select an area in the configuration (e.g. 'WLAN/General') to view the relevant search results framed in color in the configuration dialog:

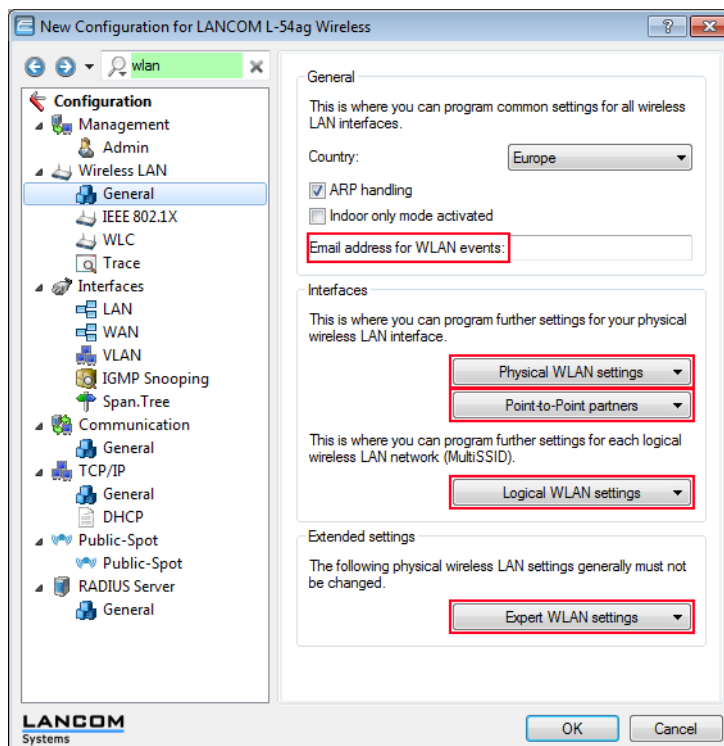

! In LANconfig version 8.50, the search results in the firewall section are not displayed in color.

3 Configuration and management

Use the navigation buttons 'forwards' and 'back' to move between the most recently visited dialogs:

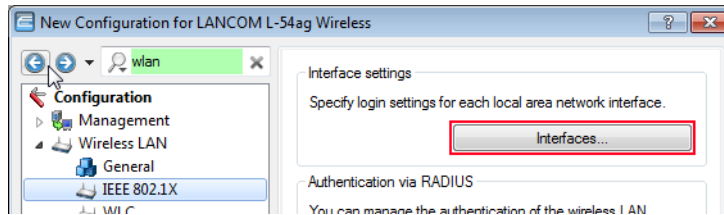

For quick access to the last 10 visited dialogs, click on the arrow to the right of the 'forwards' button:

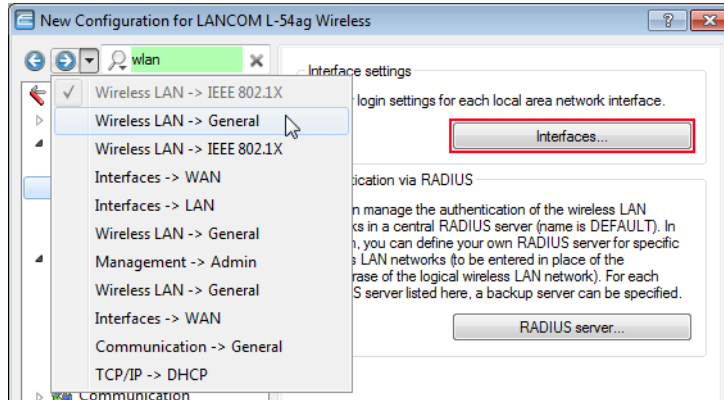

Click on the 'x' to the right of the search box to clear the search and display all entries in the configuration again.

An option to reduce the number of search results is to select the sections where LANconfig should limit the search to. Click on the magnifying glass to the left of the search box and select or deselect the required categories. Here you can also specify whether the search should highlight the results in color, or whether the configuration tree is to be reduced to the relevant dialogs only:

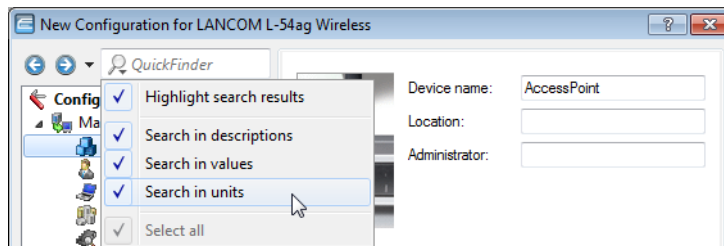

! LANconfig resets the search settings and the list of recent dialogs when the configuration is closed.

For example, your configuration may contain settings for your Internet provider. To find these you just have to enter the name to find all of the places in the configuration that refer to this provider.

You can search for text from the following areas:

- Entries in the configuration tree
- Names of the sections in each configuration dialog
- Parameters
- Values of the parameters
- Explanatory texts in the dialogs
- Table names
- Column names in tables

To use the search in LANconfig proceed as follows:

LANCOM QuickFinder in LANmonitor

Depending on the application, LANmonitor can display multiple devices with entries containing the searched term. After starting the search LANmonitor initially highlights the first finding. You can move between the search results either by using the arrow keys to the right of the search window, or by pressing Ctrl+F3 for the next occurrence and Ctrl+Shift+F3 to the previous occurrence.

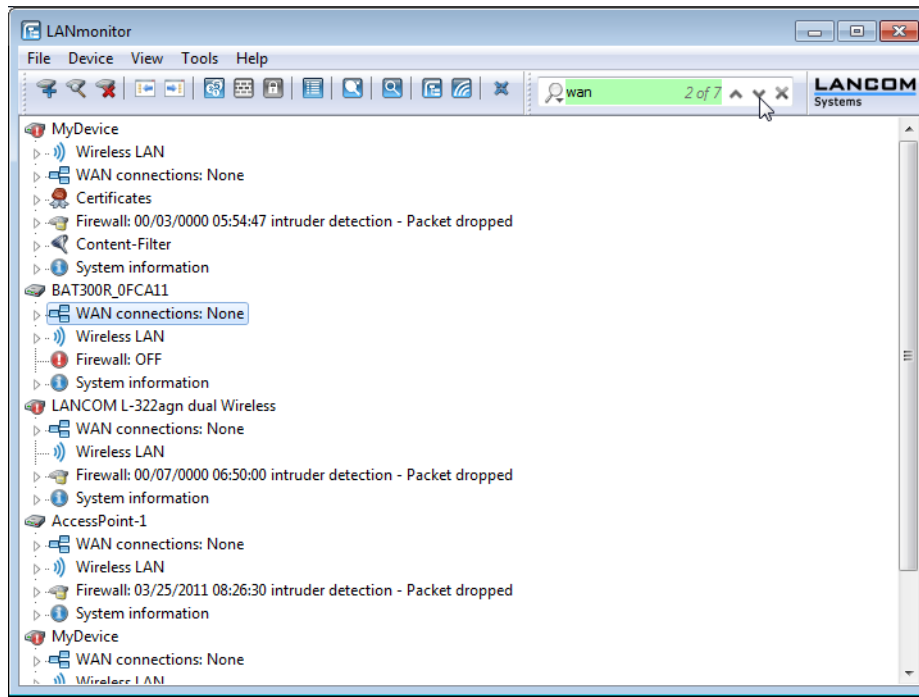

LANCOM QuickFinder in WLANmonitor

WLANmonitor includes access points and WLAN clients. Clicking on the magnifying glass on the left side of the search window opens a context menu to select the type of search. Depending on the application you can search for access points only, clients only, or all entries.

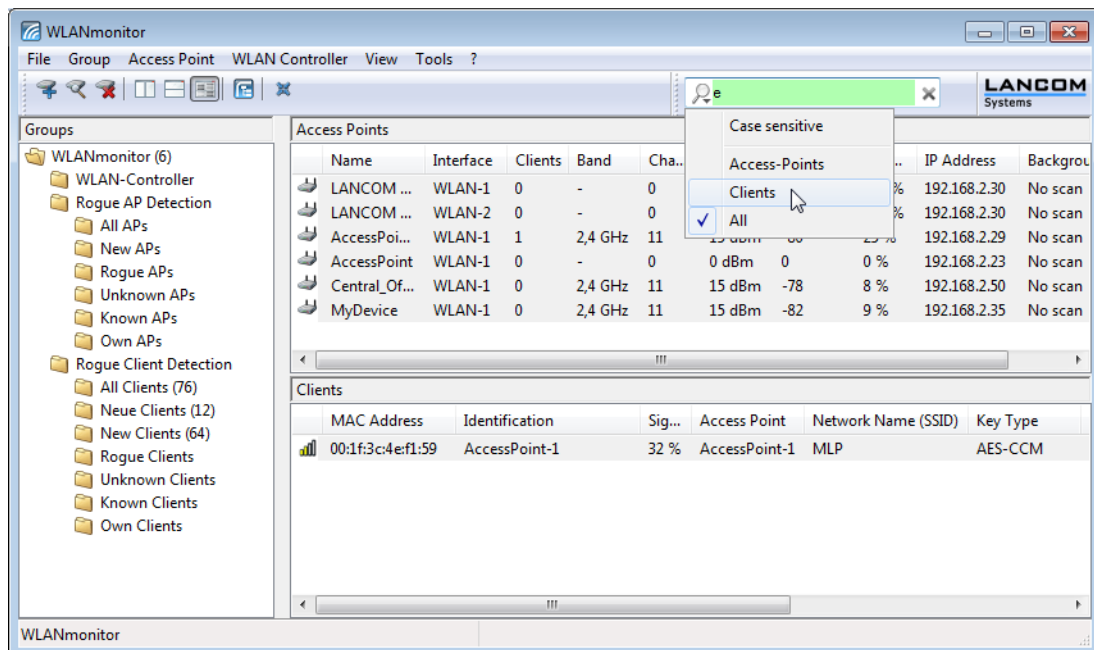

LANCOM Software Update for LCMS

The software update for LCMS allows you to automatically download new versions of the LCMS and your device firmware.

- ! New versions for LCMS (LANconfig, LANmonitor and WLANmonitor) are downloaded directly from the freely accessible download section of the LANCOM web server. Device-specific software such as new firmware versions require an account in the customer portal myLANCOM.

Manually starting the Software Update

To start the software update manually in LANconfig proceed as follows:

1. Start LANconfig.
2. Click on the Tools menu and select 'Check for updates...'

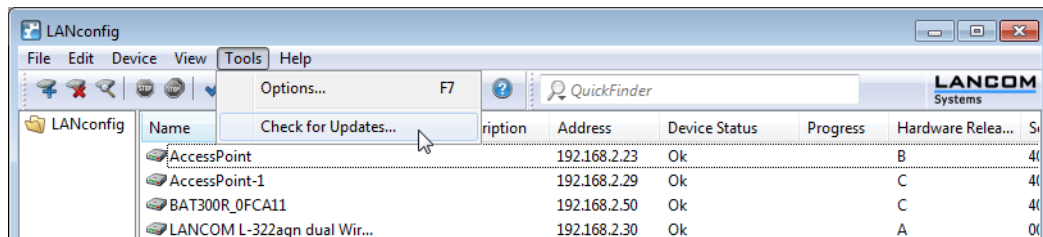

LANconfig searches the local firmware archive for updates. Optionally, you can extend the search with the following items:

- Find more updates online in the download area of the LANCOM web server.
- Include Release Candidates in the search. If you enable this option, the Software Update will not only offer to download the released software versions for use in productive environments, but also any available release candidates.

- ! Release candidates include the new features of upcoming software versions and have been thoroughly tested. Until the final release of version, the software may be further optimized—partly due to user feedback.

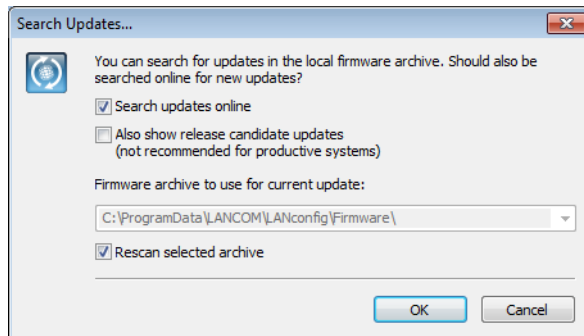

Settings for the automatic search for new updates

Proceed as follows to start the software update automatically in LANconfig each time the application starts:

1. Start LANconfig.
2. Click on the Tools menu and select 'Options...'

3. Go to the 'Update' tab.

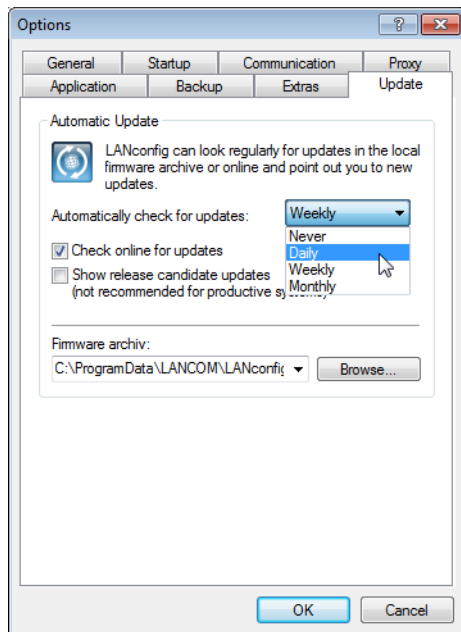

Configure the following items for the automatic update:

- Select the time interval for the automatic check for updates (daily, weekly or monthly). Alternatively, disable the automatic search with the setting 'Never'.
- Find more updates online in the download area of the LANCOM web server.
-  Release candidates include the new features of upcoming software versions and have been thoroughly tested. Until the final release of version, the software may be further optimized—partly due to user feedback. Include Release Candidates in the search. If you enable this option, the Software Update will not only offer to download the released software versions for use in productive environments, but also any available release candidates.
- Select a suitable location for the firmware archive. The firmware archive has the following functions:
 - When carrying out the automatic search for updates, LANconfig searches this location for new versions of the LCMS and the firmware.
 - This is the location where LANCOM Software Update stores the updates from the download section of the LANCOM web server.

Selecting and installing the available updates

After successful connection to the update server, LANconfig displays the available updates.

3 Configuration and management

Select the appropriate versions and click on 'Download'. As an alternative, you can click on the entries with the right-hand mouse key and select the entry 'Select all' or 'Select none' from the context menu.

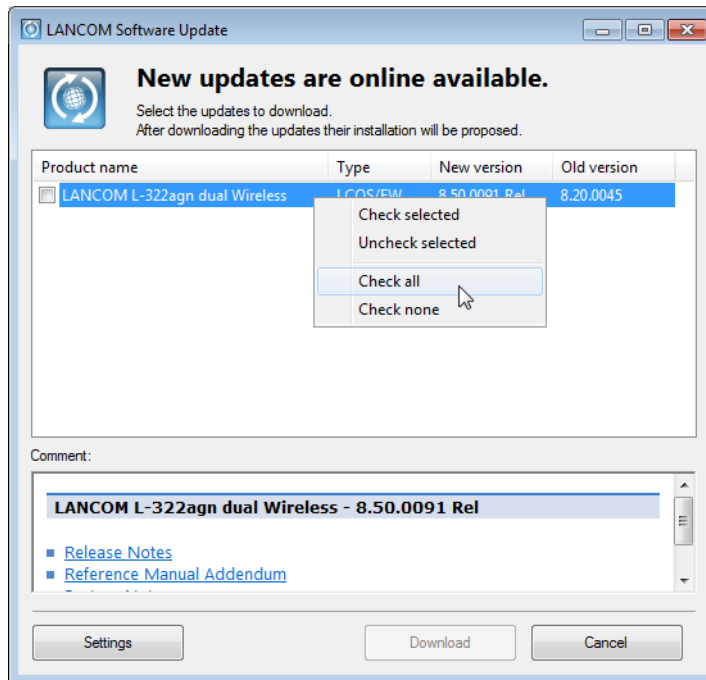

! The first time you select firmware for download, the LANCOM Software Update requests you to enter your login data for myLANCOM.

LANCOM Software Update now downloads the selected software one after other and stores the files in the firmware archive.

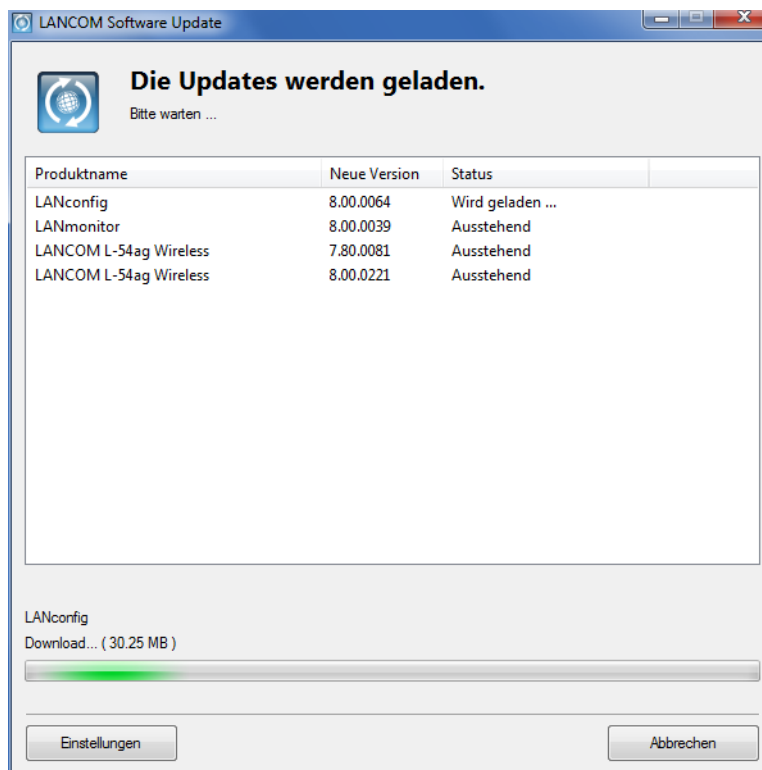

After successfully downloading the software, LANCOM Software Update offers to install the downloaded software (LANconfig and LANmonitor only):

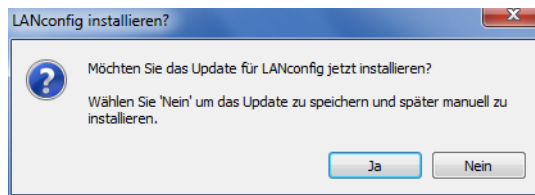

After installation, the LANCOM Software Update displays the results of the update procedure:

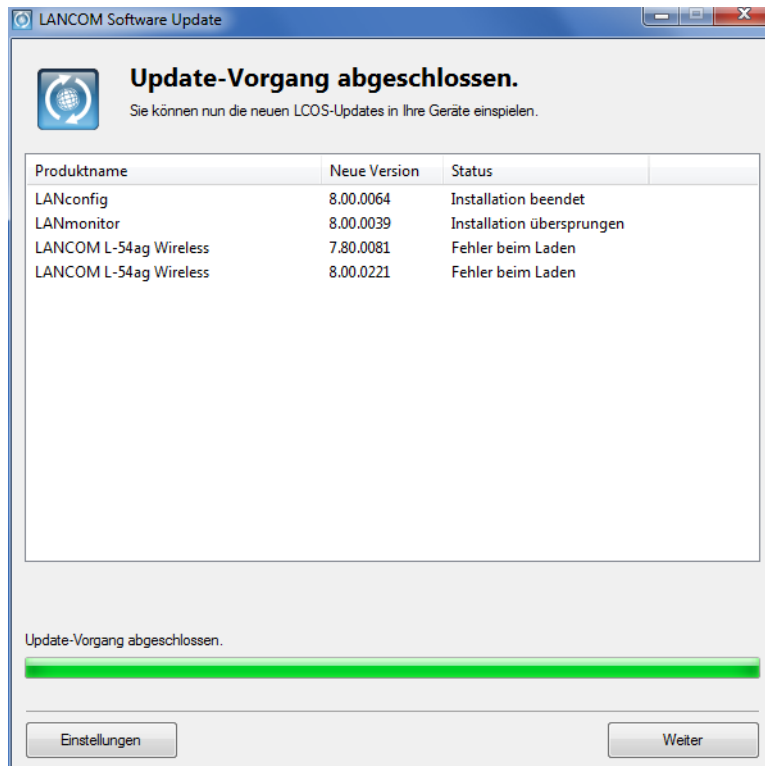

Software update via MyLANCOM

For some functions, the LANCOM Software Update requires access to the customer portal myLANCOM.

Proceed as follows to enter your myLANCOM credentials:

1. Start LANconfig.
2. Click on the Tools menu and select 'Check online for updates...'
3. In the dialog with the results of the software updates, click on the 'Settings' button.
4. In the next dialog, enter the user name and password for access to myLANCOM.

- If you wish, you can select the option 'Offer release candidate updates if available'. If you enable this option, the Software Update will not only offer to download the released software versions for use in productive environments, but also any available release candidates.

3.4.18 Addition(s) to LCOS 8.60

Exporting CSV data sets

You can export the list of devices found on the network and later import them into LANconfig in one go. LANconfig stores the list of managed devices in a CSV file.

To export the data, proceed as follows:

- Select the menu item **File > Export device list**.
- Set the location to save the file.
- Enter a file name.
- Specify the column separator, which separates the various device parameters.
- Start saving by clicking on **Save**.
- A dialog confirms the number of data sets stored.
- Close the dialog by clicking **OK**.

The CSV file that is generated contains the following data:

```
DEVICE_PATH;DEVICE_INTERFACE;DEVICE_ADDRESS;DEVICE_TIMEOUT;DEVICE_STARTUP;
DEVICE_PROTOCOLS;DEVICE_PORTS;DEVICE_ADMIN;DEVICE_PASSWORD;DEVICE_NAME;
DEVICE_DESCRIPTION;DEVICE_TYPE;DEVICE_SERNO;DEVICE_HWADDR;DEVICE_HWREL;
DEVICE_LOCATION;DEVICE_COMMENT;DEVICE_BACKUP;DEVICE_VPN
Group1;IP;192.168.2.35;10;1;263;;admin;Ht34bd5L;Etagel;L-54ag;LANCOM
L-54ag Wireless;008520600482;00a0570bc9bf;B;;;
Group1;IP;192.168.2.34;10;1;263;;admin;Ht34bd5L;Etag2;L-54ag;LANCOM
L-54ag Wireless;008520600843;00a05719a8fb;B;;;
```

The first row contains the name of the device parameters. Each row that follows contains the parameter values for one device. If 2 semicolons appear in direct succession, then the enclosed parameter value is blank.

The variable name in the first row correspond to the following LANconfig entries:

- **DEVICE_PATH**: Path name in the folder view
- **DEVICE_INTERFACE**: Connection type
- **DEVICE_ADDRESS**: IP address or domain name and COM port or telephone number respectively
- **DEVICE_TIMEOUT**: Maximum response time of the device
- **DEVICE_STARTUP**: Device check at startup

- **DEVICE_PROTOCOLS**: Communication protocols
- **DEVICE_PORTS**: Ports
- **DEVICE_ADMIN**: Administrator name
- **DEVICE_PASSWORD**: Administrator password
- **DEVICE_NAME**: Device name
- **DEVICE_DESCRIPTION**: Description
- **DEVICE_TYPE**: Device type
- **DEVICE_SERNO**: Serial number
- **DEVICE_HWADDR**: MAC address
- **DEVICE_HWREL**: Hardware release
- **DEVICE_LOCATION**: Location
- **DEVICE_COMMENT**: Comment
- **DEVICE_BACKUP**: Storage location for the configuration backup created by LANconfig
- **DEVICE_VPN**: Parameter set for 1-Click-VPN

 Use a text editor or spreadsheet to manage the list of exported devices.

 If a device password is stored in LANconfig, the password is saved in plain text in the CSV file. Remember to delete these access credentials before you pass this file on or save it to a freely accessible server.

Additions to the menu system

File

The menu item 'File' is used to manage devices in general and to exit LANconfig.

Export device list

You can export the list of devices found on the network and later import them into LANconfig in one go. LANconfig stores the list of managed devices as a CSV file.

Importing from a data source

In LANconfig you can import a large number of devices from a script file in one go by processing the device files with an Import Wizard. You also have the option of using this device file together with a configuration template file to create a custom configuration file for each device. The template file contains variables for the values in the device file.

 The device file is saved in CSV format.

Additions to the menu system

File

The menu item 'File' is used to manage devices in general and to exit LANconfig.

Devices/configurations from CSV file...

In LANconfig you can import a large number of devices from a script file in one go by processing the device files with an Import Wizard. You also have the option of using this device file together with a configuration template file to create a custom configuration file for each device. The template file contains variables for the values in the device file.

Example application: Importing from a single data source

This scenario describes how to use a script file and a simple CSV-format device file to generate your own data source for importing data.

Content of the CSV file

The CSV file contains device-related data records, which LANconfig can import. This provides you with a convenient method of managing this data on the network.

The following is an example of a simple CSV file:

```
CONFIG_FILENAME;DEVICE_PATH;DEVICE_INTERFACE;DEVICE_ADDRESS;DEVICE_LOCATION;DEVICE_NAME;KEY;USER
Fil52146.lcs;Affiliate/NRW;IP;192.168.1.1;Wuerselen;Fil52146;secret1;user1@internet
Fil80637.lcs;Affiliate/BAY;IP;192.168.2.1;Muenchen;Fil80637;secret2;user2@internet
```

The header contains the names of the device parameters. The following lines itemizes the various devices line by line, and their parameters are separated by semicolons. If 2 semicolons appear in direct succession, then the enclosed parameter value is blank.

The parameter names on the first line can be freely defined. If you decide to use the standard LANCOM variable names, LANconfig automatically allocates the device parameters during the import.

- **DEVICE_PATH**: Path name in the folder view
- **DEVICE_INTERFACE**: Connection type
- **DEVICE_TIMEOUT**: Maximum response time of the device
- **DEVICE_STARTUP**: Device check at startup
- **DEVICE_PROTOCOLS**: Communication protocols
- **DEVICE_PORTS**: Ports
- **DEVICE_ADMIN**: Administrator name
- **DEVICE_PASSWORD**: Administrator password
- **DEVICE_NAME**: Device name
- **DEVICE_DESCRIPTION**: Description
- **DEVICE_BACKUP**: Storage location for the configuration backup created by LANconfig
- **DEVICE_VPN**: Parameter set for 1-Click-VPN

If you choose not to use the LANCOM default variable names, you may need to manually assign the values to the appropriate device properties in LANconfig during the import.

Content of the configuration template file

The template file contains Telnet commands that Telnet executes sequentially. This is why this template file is also referred to as a script file.

 For an overview of the available Telnet commands see the Reference Manual chapter "Configuration with different tools" under "Telnet".

A configuration template file can appear as follows:

```
lang English
flash No
set /Setup/Name "$DEVICE_NAME$"
set /Setup/SNMP/Location "$DEVICE_LOCATION$"
cd /Setup/TCP-IP/Network-list
tab Network-name IP-Address IP-Netmask VLAN-ID Interface Src-check Type
Rtg-tag Comment
add "INTRANET" $DEVICE_ADDRESS$ 255.255.255.0 0 any loose Intranet 0
```



```

"local intranet"
cd /
cd /Setup/WAN/PPP
tab Peer Authent.request Authent-response Key Time Try Conf Fail Term
Username Rights
add "INTERNET" none PAP "$KEY$" 6 5 10 5 2 "$USER$" IP
cd /
cd /Setup/WAN/DSL-Broadband-Peers
del *
tab Peer SH-Time AC-name Servicename WAN-layer ATM-VPI ATM-VCI MAC-Type
user-def.-MAC DSL-ifc(s) VLAN-ID
add "INTERNET" 9999 "" "" "PPPOEOA" 1 32 local 000000000000 "" 0
cd /
cd /Setup/IP-Router/IP-Routing-Table
tab IP-Address IP-Netmask Rtg-tag Peer-or-IP Distance Masquerade Active
Comment
add 255.255.255.255 0.0.0.0 0 "INTERNET" 0 on Yes "default route"
cd /
flash Yes

# done
exit

```

The variables begin and end with a character or a string (here:'\$').

In this template file, the variables represent certain device parameters. During the import process, you associate these variables with the corresponding entries in the device file. The Configuration Wizard then replaces the variables with the associated device data from the CSV file.

Creating the configuration files

Proceed as follows to create device-specific configuration files:

1. Open the Import Wizard in the menu **File > Devices/Configurations from CSV file...**
2. If necessary, confirm the Welcome dialog with **Next**. The option to **Skip this page on next call** will suppress the appearance of the welcome screen when the Wizard is run in future.
3. If applicable, select the profile used for a previous data import. The option **Skip profile settings and start the import immediately** uses the settings in the selected profile without modification. Select **<New profile>** to use a new profile instead of an existing one. Click on **Next**.

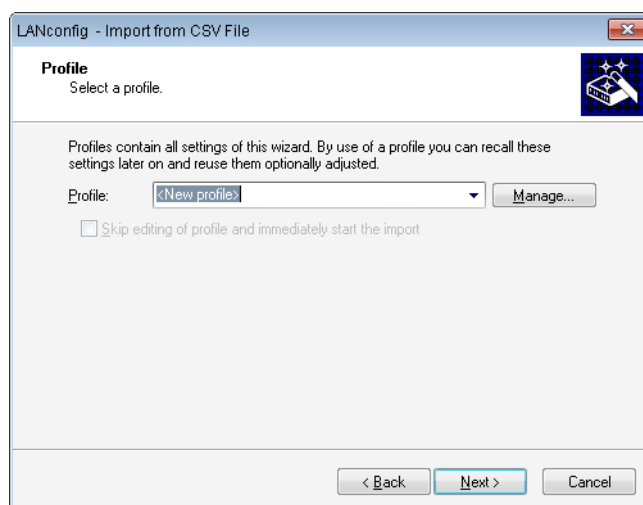

4. In the **Data source** field enter the path to the CSV file. With **Browse ...** you select the file from your local file system.

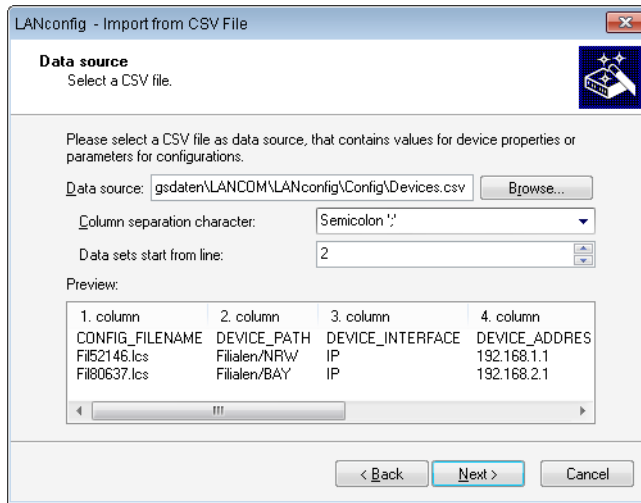

5. You can select the column delimiter in the CSV file. The default is the semicolon.
6. Set the row number where the data records start. This allows you to avoid importing any existing column headings and additional information. If a line in the CSV file contains only LANCOM default variable names (see section [Exporting CSV data sets](#)), then this line is used to assign the variables automatically. This ensures that exporting and importing the same file will function without any manual assignment. However, if a configuration is generated with additional variables, the auto-detect will not function.
7. The **Preview** field instantly shows the parameters you have selected for import. Confirm your entries with **Next**.
8. To use the data records to create new devices in LANconfig, select the option **Automatically create devices in LANconfig**. After clicking **Next**, the following pages are used to select the device properties to be carried over to LANconfig.

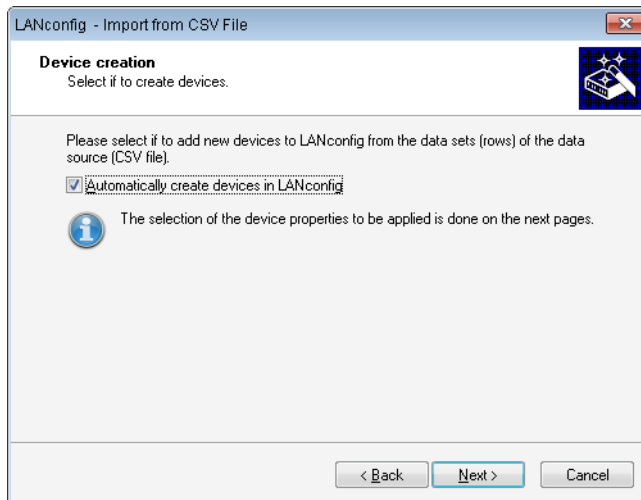

- ! If this option is disabled, the Wizard will skip the subsequent 2 steps.

9. The devices are identified using their connection address. Use the drop-down list to select the column in the data set that contains the connection address and click on **Next**. If you use LANCOM default variable names, assignment takes place automatically.

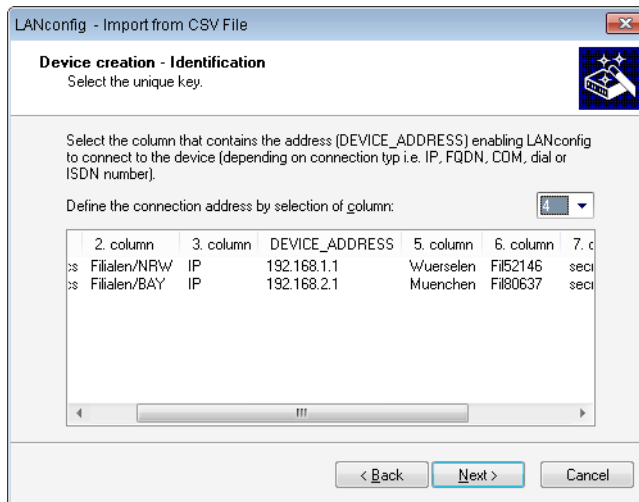

10. Align the columns according to the relevant device properties. Properties that have been aligned are marked in the list with a preceding "+". Then click on **Next**. If you use LANCOM default variable names, assignment takes place automatically.

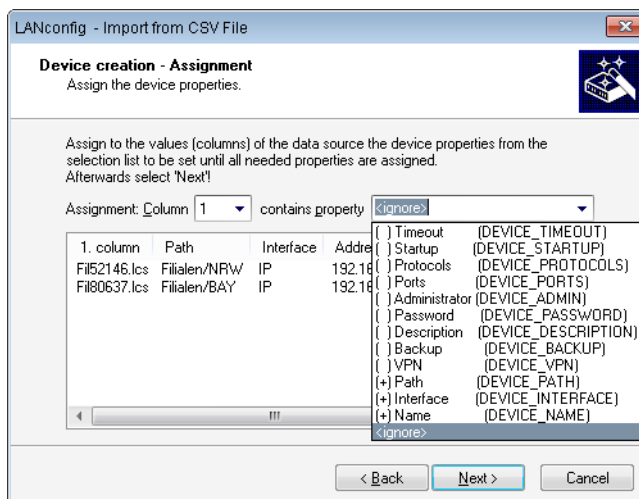

11. You have the option to create individual configuration files from the data sets. Simply activate the option **Generate configuration files**.

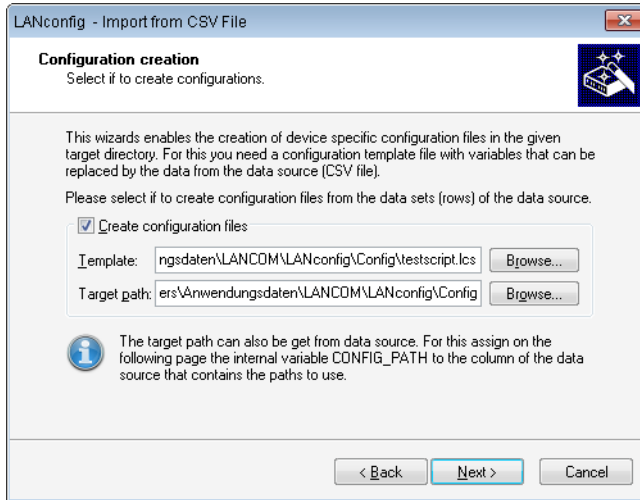

12. Use the **Template** field to set the path to the template file to be used as the basis for these configuration files. By clicking on **Browse** you open the dialog for loading a configuration script template. In the fields **Variable start** and **Variable end** you define which characters (or strings) are to mark the start and end of the variables in the template file. This enables the Wizard to identify the variables in the template file.
13. You determine the storage path in the field **Target path**. This is where LANconfig stores the new configuration files. Click on **Browse** to specify a target path on your local file system. Click on **Next**.
14. Assign the columns in the data source to the variables used in the template file. Do this by selecting the column number from the list of columns and assigning this number to a variable from the properties list. Variables are also assigned automatically if the column headings contain the same variable names as those between the start and end characters in the script file. The column headings in the view below updates immediately with every change. To continue, click on **Next**.

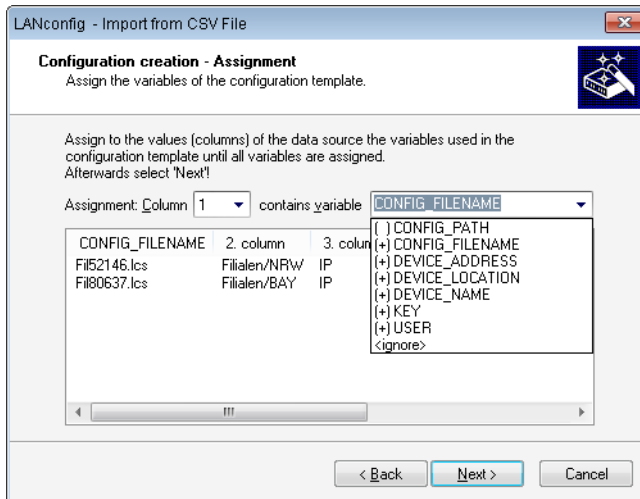

! If your entries are incomplete, the Wizard alerts you about potential import problems and suggests corrections.

15. The summary informs you about the actions that are executed in the next step. If you need to make any changes, click on **Back**. This returns you to the appropriate input mask. By clicking on **Next** you start the data import.

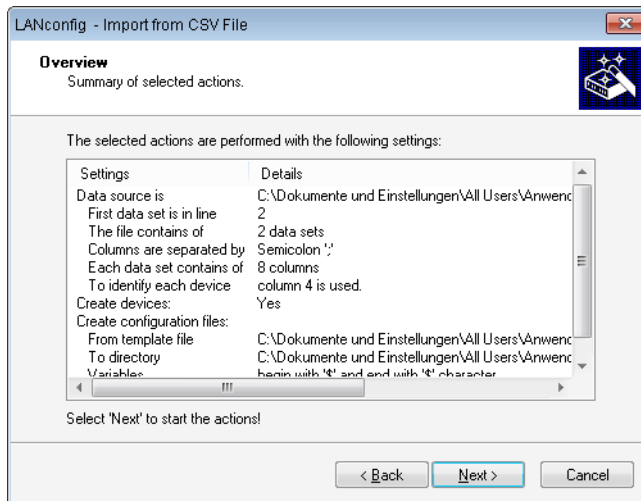

! If the data import would overwrite a device that already exists in LANconfig, the Wizard gives you the following options:

- Overwrite the device.
- Create a configuration file anyway.
- Use this decision for all other existing devices.

16. The status dialog that follows indicates the actions performed. Click on **Copy to clipboard** to save the status message to the clipboard. Click on **Next**.
17. Finally, you have the option to save the current import settings to a profile for future actions.
18. Complete the import by clicking on **Finish**.

If you have opted to generate a custom configuration file, the Wizard saves a separate configuration file for each device in the specified folder. These configuration files are named according to the file name "<CONFIG_FILENAME>.lcs", which defines the CSV file:

```
lang English
flash No
set /Setup/Name "Fil52146"
set /Setup/SNMP/Location "Wuerselen"
cd /Setup/TCP-IP/Network-list
tab Network-name IP-Address IP-Netmask VLAN-ID Interface Src-check Type
  Rtg-tag Comment
add "INTRANET" 192.168.1.1 255.255.255.0 0 any loose Intranet 0 "local
intranet"
cd /
cd /Setup/WAN/PPP
tab Peer Authent.request Authent-response Key Time Try Conf Fail Term
  Username Rights
add "INTERNET" none PAP "secret1" 6 5 10 5 2 "user1@internet" IP
cd /
cd /Setup/WAN/DSL-Broadband-Peers
del *
tab Peer SH-Time AC-name Servicename WAN-layer ATM-VPI ATM-VCI MAC-Type
  user-def.-MAC DSL-ifc(s) VLAN-ID
add "INTERNET" 9999 " " " " "PPPOEOA" 1 32 local 000000000000 " " 0
cd /
cd /Setup/IP-Router/IP-Routing-Table
tab IP-Address IP-Netmask Rtg-tag Peer-or-IP Distance Masquerade Active
```

3 Configuration and management

```

Comment
add 255.255.255.255 0.0.0.0 0 "INTERNET" 0 on Yes "default route"
cd /
flash Yes

# done
exit

```

The Wizard has replaced all variables with the appropriate device parameters.

This configuration file gives you the option to use LANconfig to transfer the device settings as defined in the template file to other devices. Highlight the appropriate device and click on **Device > Configuration management > Restore script from script file**.

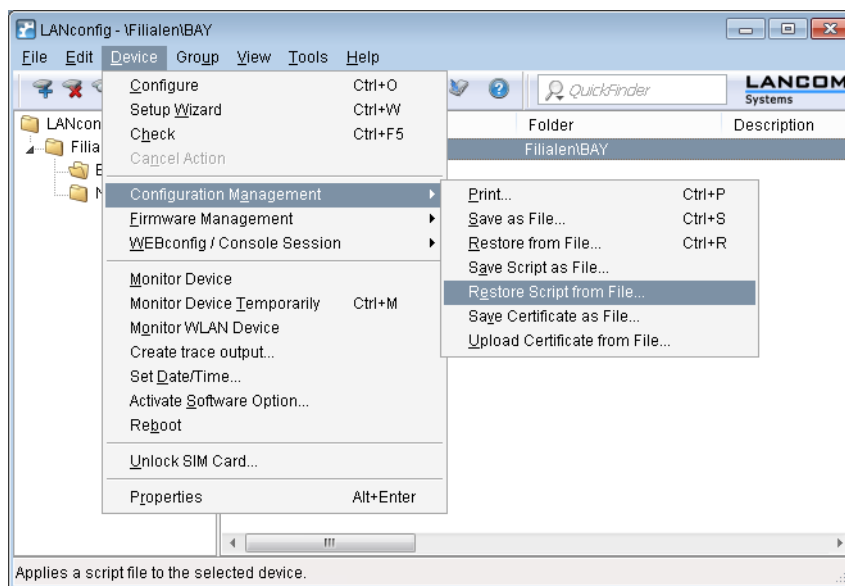

Better overview in LANconfig with more columns

As a help for large-scale projects, LANconfig provides a better overview and quicker orientation with its columns featuring device-related details that can be shown or hidden according to your needs. Choose the columns to be displayed from **View > Select columns**. The menu item **View > Arrange icons** allows you to sort the items as you prefer.

- ! Sort the view by clicking with the left mouse button in the appropriate column heading. Each new click reverses the sorting.

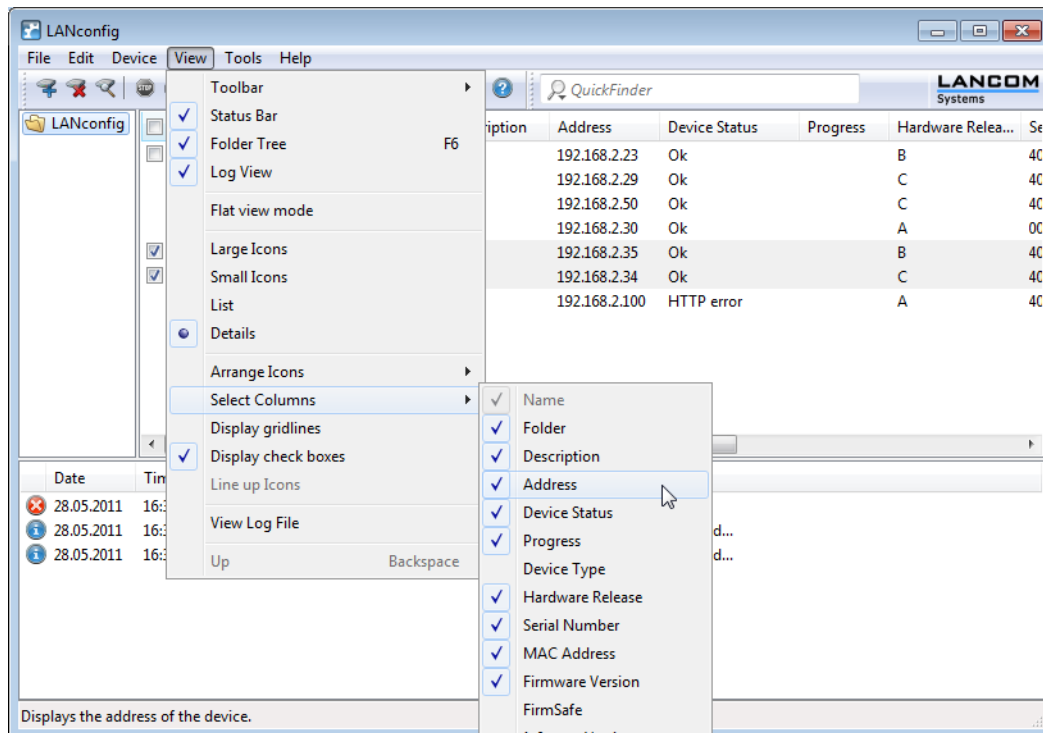

The following details can be displayed in the various columns:

- Name
- Folder
- Description
- Comment
- Address
- Location
- Device status
- Progress
- Device type
- Product code
- Hardware release
- Serial number
- MAC address
- Firmware version
- FirmSafe
- 1) Image version
- 2) Image version

With **Select all** or **Hide all** you can show or hide all columns with just one click.

 The column **Comment** contains the information in comment field 1 for the device.

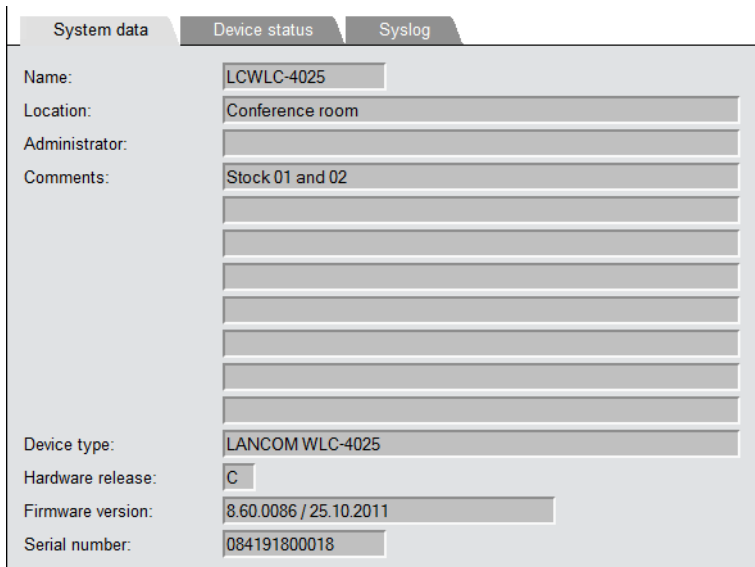

The screenshot shows the 'System data' tab in LANconfig. The fields are as follows:

Name:	LCWLC-4025
Location:	Conference room
Administrator:	
Comments:	Stock 01 and 02
Device type:	LANCOM WLC-4025
Hardware release:	C
Firmware version:	8.60.0086 / 25.10.2011
Serial number:	084191800018

3.4.19 Addition(s) to LCOS 8.80

Creating a password in LANconfig

LANconfig provides the option to automatically generate a password at all points in the configuration, which require the input of a password or a passphrase.

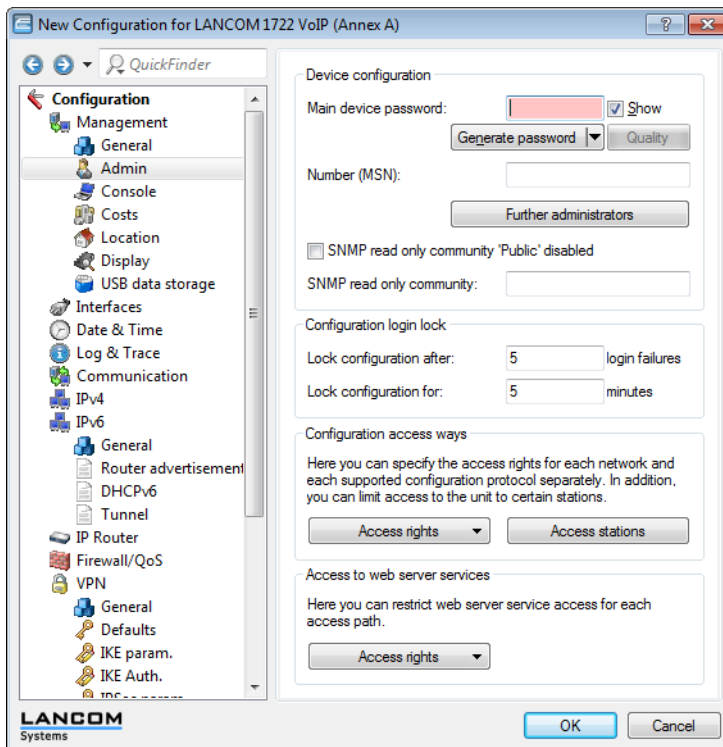

The screenshot shows the 'New Configuration for LANCOM 1722 VoIP (Annex A)' dialog box. The 'Device configuration' section includes:

- Main device password: Show
- Buttons: Generate password, Quality
- Number (MSN):
- Button: Further administrators
- SNMP read only community 'Public' disabled
- SNMP read only community:

The 'Configuration login lock' section includes:

- Lock configuration after: 5 login failures
- Lock configuration for: 5 minutes

The 'Configuration access ways' section includes:

- Buttons: Access rights, Access stations

The 'Access to web server services' section includes:

- Button: Access rights

At the bottom, there are 'OK' and 'Cancel' buttons.

Enable the option **Show** next to the box for entering the password. Then click on the button **Generate password** to create a password suggestion.

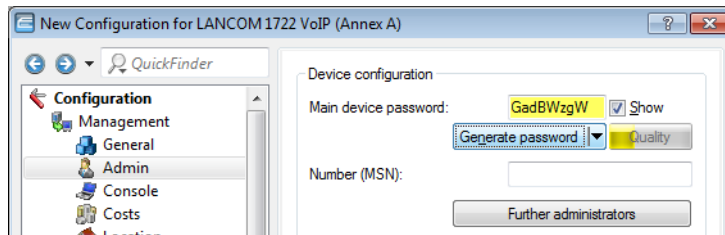

Optionally click the arrow next to the **Generate password** button to open the dialog box for the password policy settings.

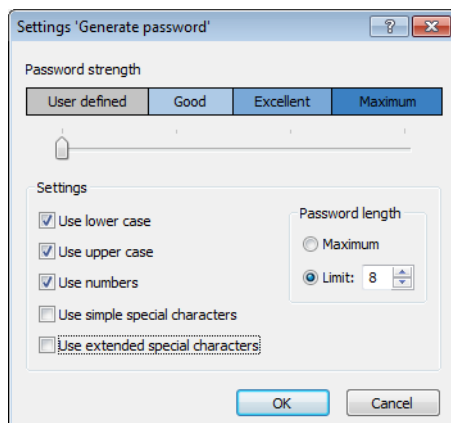

Use the slider to set the desired password strength. With the **User defined** setting, you can define the maximum password length and the required character types. The settings **Good**, **Very good** and **Maximum** are predefined settings with reasonable, non-modifiable values.

After making your changes, click on the **Generate password** button again to create a new password proposal in line with your password guidelines.

! LANconfig stores the current settings in this dialog box for the current user.

Internal browser in LANconfig

Until now, LANconfig opened WEBconfig in the system's default browser. As of LCOS version 8.80, you have the option of starting LANconfig's own internal browser as an alternative.

LANconfig menu structure

Using the menu bar, you can manage devices and their configurations, and you can customize the appearance and functioning of LANconfig.

Device

Under the menu item **Device** you can edit the configurations of devices connected to the network, organize firmware updates and monitor device connections.

The functions in the **Device** menu are only offered for selection if at least one device has been chosen from the list of devices. The menu can also be called by clicking on a device with the right mouse button when it is marked.

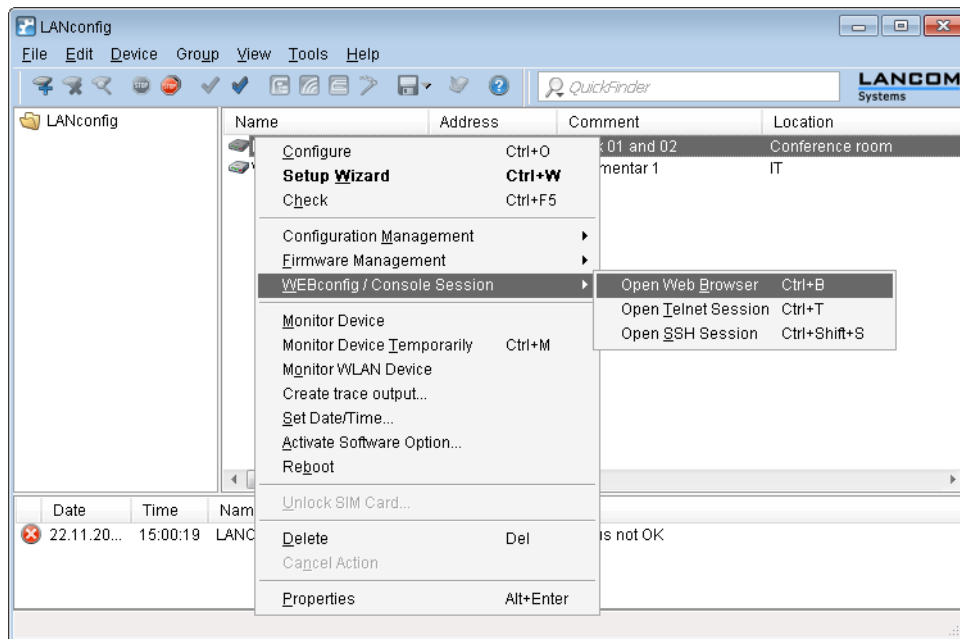
WEBconfig / console session

You can select the following actions under **Device > WEBconfig / console session**:

Open web browser

Opens the web browser for the device marked.

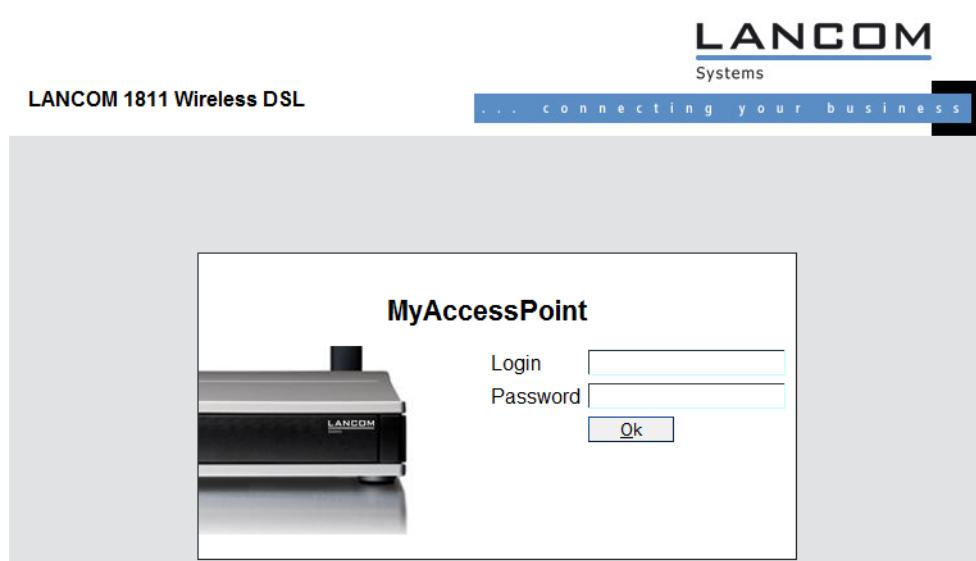

! Under **Tools > Options > Extras > Browser used to display WEBconfig**, you choose whether LANconfig should use the system default browser or its own internal browser.

Open Telnet session

Opens the telnet session.

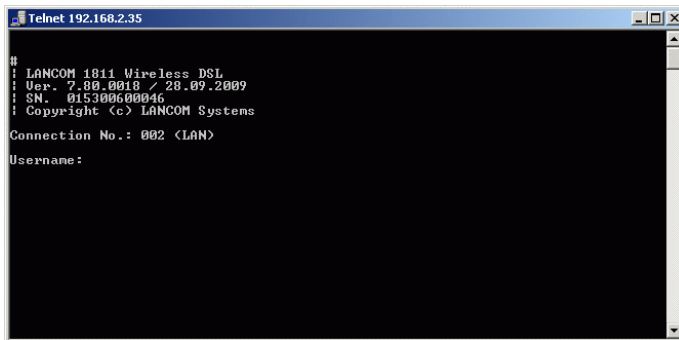

Open SSH session

Opens a configuration session with an SSH client.

! For Telnet and SSH connections, you must specify the programs that LANconfig should use to connect to the device. Set these items under **Tools > Options > Extras > External programs**.

Extras

Clicking on **Tools > Options** opens up the dialog box for further optional settings. (You can also reach this dialog box by pressing F7).

Options

Under the menu item **Options** you can invoke additional functions, for example to communicate with connected devices, invoke external applications, or carry out automatic searches for firmware updates.

Extras

This dialog window allows you to make **additional settings**.

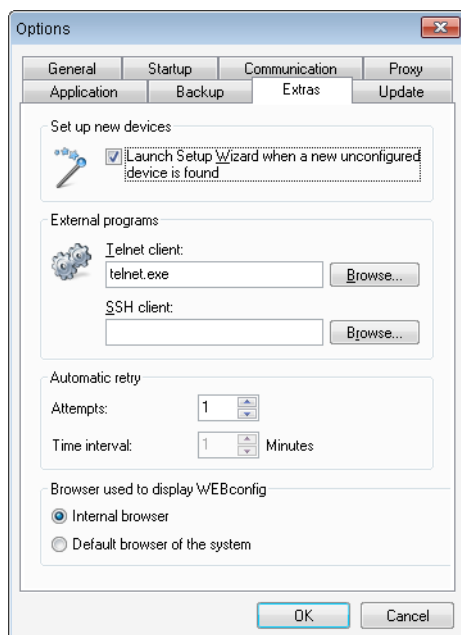

Set up new devices

If this option is checked, LANconfig launches the Setup Wizard whenever it finds an unconfigured device.

External programs

This item determines the executable files for the Telnet client and the SSH client to be used by LANconfig for connections to the devices.

Automatic retry

Attempts

Specify the number of attempts for a firmware or configuration upload.

You can set a number between 1 and 9999. LANconfig always attempts to make a connection. If this fails a retry is attempted after the defined interval. The operation is retried until LANconfig reaches the number of defined attempts or until the operation succeeds. LANconfig may terminate the retries if a situation arises in which completion is unlikely without external intervention. This may be when the device cannot open a file, for example.

Time interval

Enter the time interval in minutes between two attempts to upload the firmware or configuration. You can set an interval between 1 and 9999.

Browser used to display WEBconfig

This item sets the default browser used by LANconfig to display WEBconfig. You can choose between your operating system's default browser and LANconfig's internal browser, LCCEF (LANCOM Chromium Embedded Framework).

Setting the SNMP read-only community 'Public'

In LANconfig, the setting for the SNMP read-only community 'Public' is to be found under **Management > Admin**.

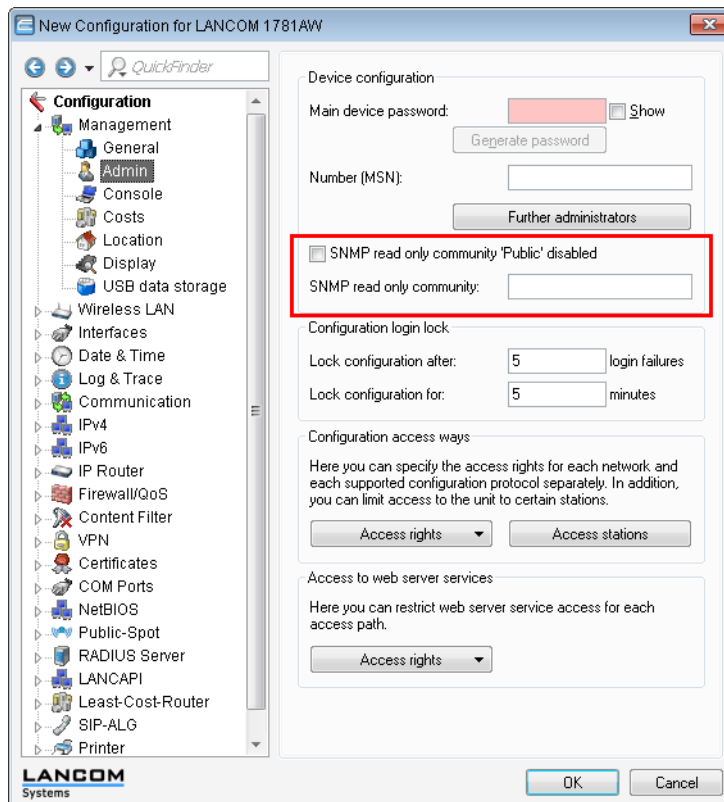

Quicklinks for managing source tables

Values can be selected from an input field after they have previously been specified in one or more tables. So-called Quicklinks offer you a direct way to manage these source tables. This allows you to bypass the default configuration order. Instead of creating new elements after first exiting the current selection, you can create these items directly if necessary. These new elements are immediately available for selection.

To clarify the structure of the configuration, LANconfig shows the configuration path apart along with the individual sources. If the configuration parameters can be chosen from multiple source tables, LANconfig groups the entries accordingly. For each group, LANconfig additionally specifies the number of entries contained.

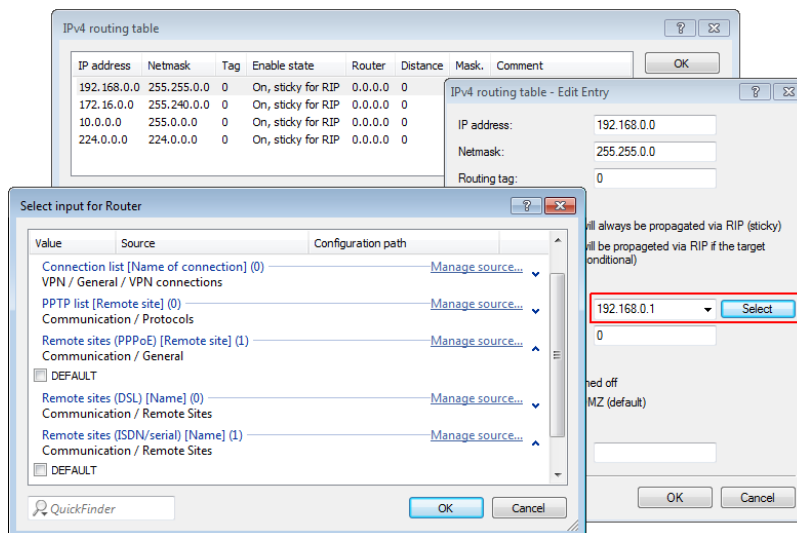

3.4.20 Addition(s) to LCOS 8.82

SSH configuration protocol in LANconfig

In conjunction with CC compliance (Common Criteria), LANconfig supports the configuration of LANCOM CC products via SSH or data transfer via SCP as of the LCOS version 8.82.

Enhancements to LANconfig

Device-specific settings for communications protocols

The transfer of configuration data when working with LANconfig can be handled by various protocols: HTTPS, SSH, HTTP or TFTP.

Widely available protocols are defined globally. In addition, it is possible to disable protocols for specific devices. However, it is not possible to re-enable a globally disabled protocol for an individual device.

Configuration of the global communication settings

The configuration of the communication protocols differentiates between the protocol strictly for testing the device and the protocols for other operations, such as firmware uploads, etc.:

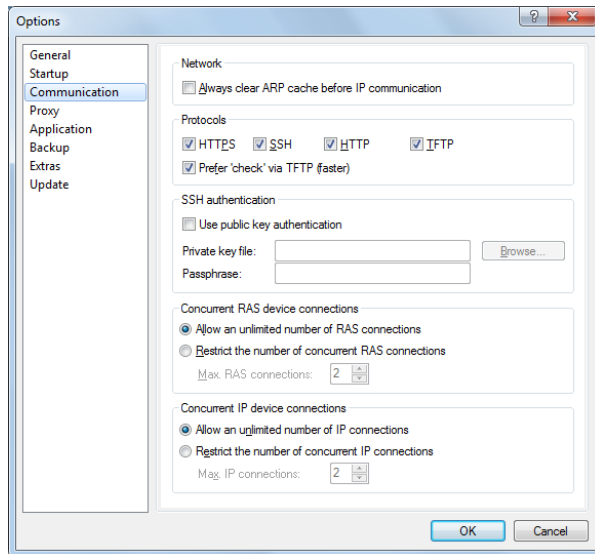

LANconfig: **Extras > Options > Communication**

- **HTTPS, SSH, HTTP, TFTP**

When this is selected, you enable the individual protocols for the operations firmware upload, configuration up/download, and script up/download. In these operations, LANconfig attempts to use these protocols in the order HTTPS, SSH, HTTP and TFTP. If the transfer fails when using one of the selected protocols, LANconfig automatically tries the next protocol.

- **Prefer checks via TFTP**

The device evaluation only transfers small amounts of data with the system information. As such, it makes sense to perform device checks in the LAN by TFTP protocol. When this option is activated, LANconfig first uses the TFTP protocol to check the device, regardless of the communication protocols set previously. If the check via TFTP fails, then LANconfig attempts the protocols HTTPS, SSH, and HTTP.

- **Using public key authentication**

If you have selected the SSH protocol, you can alternatively perform the authentication via a private key. In this case, the authentication dialog for password entry is not invoked. Enter the path to your private key file in the fields, and, if necessary, the passphrase that you used to encrypt the file. Load the corresponding public key with LANconfig or WEBconfig onto each device.

 The global communication settings take precedence over the device-specific settings in order to prevent, for example, the central use of a protocol.

LANconfig menu structure

Using the menu bar, you can manage devices and their configurations, and you can customize the appearance and functioning of LANconfig.

File

The menu item **File** is used to manage devices in general, and to exit LANconfig as needed.

Add device

You can add a new device under **File > Add device**. A window is displayed where you can make the settings for the device, the connection, and backups.

General

Interface

In **Interface** you can configure the connection settings for a device.

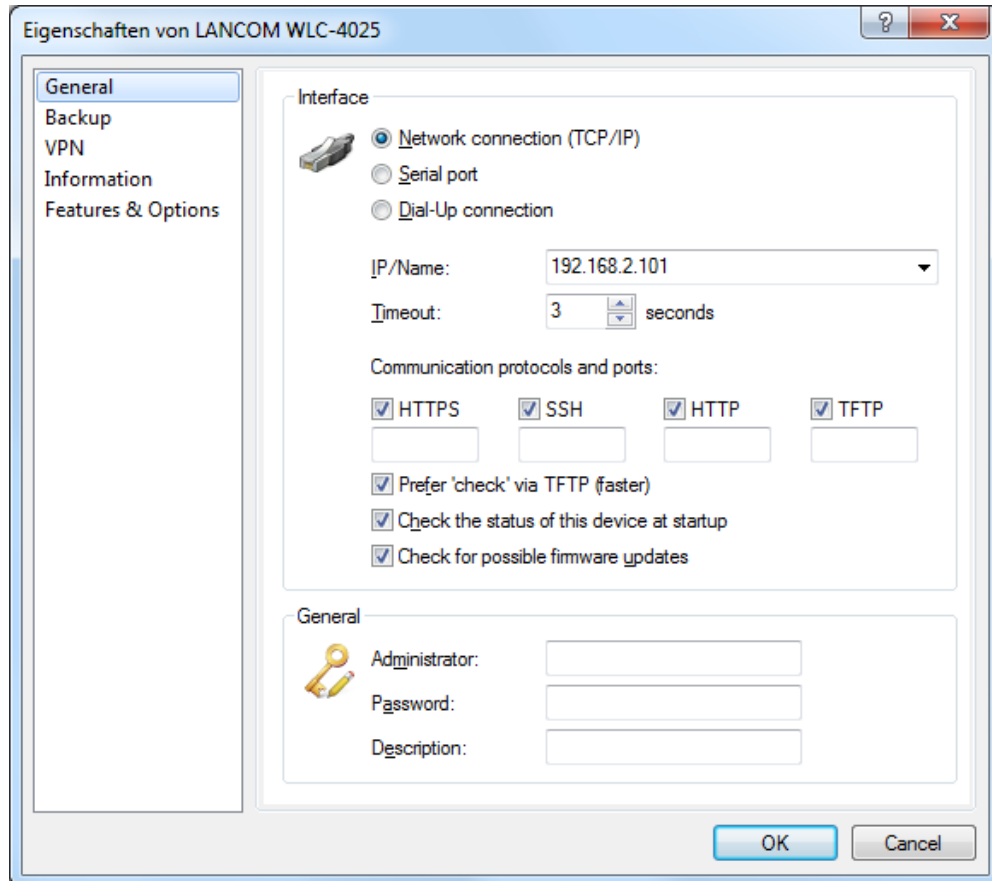

Please select how the device is to be reached:

- **Network connection (TCP/IP):** Select this option if the device can be reached over an IP network.
- **Serial port:** Select this option if the device is connected directly to your computer's serial port.
- **Dial-up connection:** Select this option if the device can be reached via Dial-Up Networking.



Please note that some routers do not support remote configuration via a dial-up connection.

- **IP/Name:** Enter the IP address of the device. You can also enter a domain name (DN or FQDN) or a NetBIOS name. This name is checked at every access. LANconfig stores and uses the resolved IP address. If this check is not possible, then LANconfig takes the last IP address that was last used successfully.
- **Timeout:** Here you enter how many seconds the program should wait for a response from this device.
- **HTTPS, SSH, HTTP, TFTP:** When this is selected, you enable the individual protocols for the operations firmware upload, configuration up/download, and script up/download. In these operations, LANconfig attempts to use these protocols in the order HTTPS, SSH, HTTP and TFTP. If the transfer fails when using one of the selected protocols, LANconfig automatically tries the next protocol.
- **Prefer 'check' via TFTP:** This option causes LANconfig to perform checks with TFTP, irrespective of other protocols that are selected. This is advantageous for devices located in the LAN. The checks are faster and place less load on the computer, which makes an appreciable difference when processing a large number of devices. The fact that HTTPS is not used should not be a problem in the LAN.

- **Check the status of this device at startup:** Check this box if LANconfig should check the status of the device every time it is started.
- **Check for possible firmware updates:** Select this option if LANconfig should check for possible firmware updates.

As described in the section 'Communication protocols and ports', LANconfig tests other protocols and executes them if TFTP is not available. Here, too, global settings take priority over the device-specific settings.

After you have made the settings, the program tries to access the device and retrieve its name and version. If this fails, LANconfig shows a short error message in the **Device status** column.

General

In this section you can access the credentials for the device and enter a description.



The screenshot shows a window titled 'General' with a key icon. It contains three input fields: 'Administrator:', 'Password:', and 'Description:'.

- **Administrator:** Enter the username for the administrator.
- **Password:** Enter the associated password here.
- **Description:** Enter the description of the device that you want LANconfig to display in the main window.

LANconfig stores the credentials persistently, so that you no longer need to enter them when re-accessing the device.



If you save the username and password permanently, any user who is permitted to run LANmonitor also has access to the device.

Communication protocols and ports

LANconfig performs these checks, i.e. the transfer of system information, by using the communications protocols set here.

LANconfig performs device actions such as uploading scripts, firmware and configurations, as well as configuration download, with the communications protocols selected here.



For devices with LCOS versions predating version 5.20, LANconfig uses the TFTP protocol for all actions, irrespective of the protocols set here.

LANconfig attempts to carry out the device actions outlined above in the order HTTPS, SSH, HTTP, and TFTP and SSH. If an action fails because of the protocol, then LANconfig repeats them with the next selected protocol.

At least one protocol must be selected in order for the action to function.



When using HTTP(S) and a proxy server, it may be necessary to circumvent this proxy server so that LANconfig can reach the device. You can bypass the proxy server for local addresses by using a setting in the Window's Control Panel, Internet options. In the Internet options' advanced settings, you can also define further addresses which should not be contacted via the proxy server.

Protocols can be set globally or by means of device-specific settings. The global settings in the options menu take priority over the device-specific settings. A benefit of this is that a single global switch can be used to disable a protocol for all devices.

Tips

- When shipped, the device does not yet have an IP address. In this case, enter the IP address of your computer and replace the last part of the number sequence by 254: If your computer's IP address is 192.168.1.1, then assign the IP address 192.168.1.254 to the device.
- Also, if you do not know the device's IP address, you additionally have the option of searching for it with **File > Devices**.

Potential problems when connecting with a new device

If LANconfig cannot reach a device at all, then one of the following error messages is displayed under status.

To check a device again, mark it in the list and click on **Device > Check** in the menu bar.

- **Serial error:** LANconfig could not open the serial interface. Close any program that may be accessing the port.
- **IP error:** Check that the IP address of the device is correct and that your computer is properly connected to the network. You can also check that the TCP/IP protocol is installed properly and correctly configured.
- **No response:** Check if the IP address of the device is correct. Another possibility is that the network connection between your computer and the device is too slow or unreliable.
- **Status unknown:** LANconfig reached the device via the specified IP address, but was unable to request any additional information. LANconfig may not support this device.
- **Access denied:** Access to this device from your computer is blocked.

Device

Under the menu item **Device** you can edit the configurations of devices connected to the network, organize firmware updates and monitor device connections.

The functions in the **Device** menu are only offered for selection if at least one device has been chosen from the list of devices. The menu can also be called by clicking on a device with the right mouse button when it is marked.

WEBconfig / console session

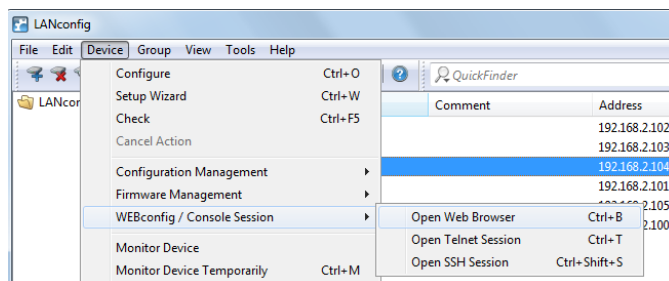

You can select the following actions under **Device > WEBconfig / console session**:

Open web browser

Opens the web browser for the device marked.

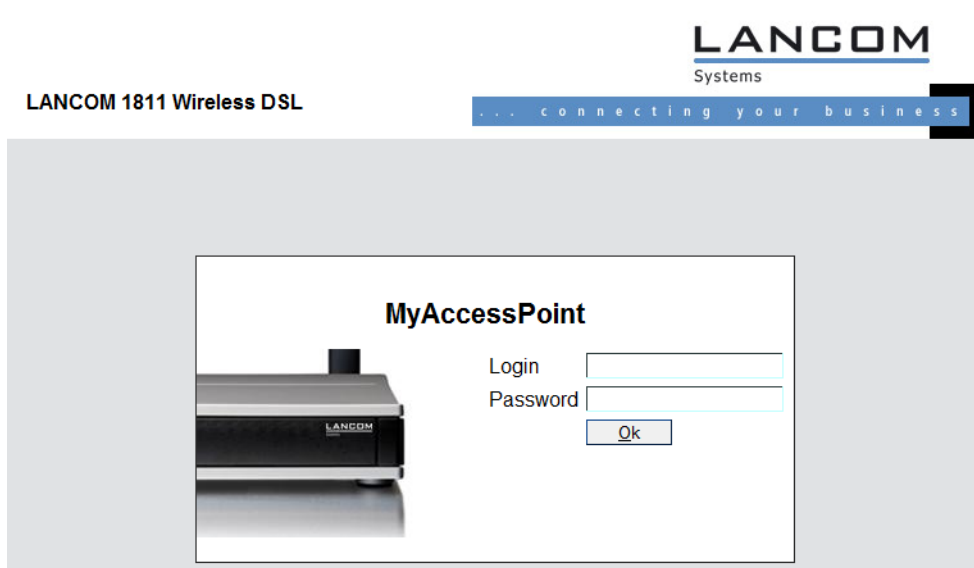

! Under **Tools > Options > Extras > Browser used to display WEBconfig**, you choose whether LANconfig should use the system default browser or its own internal browser.

Open Telnet session

Opens the telnet session.

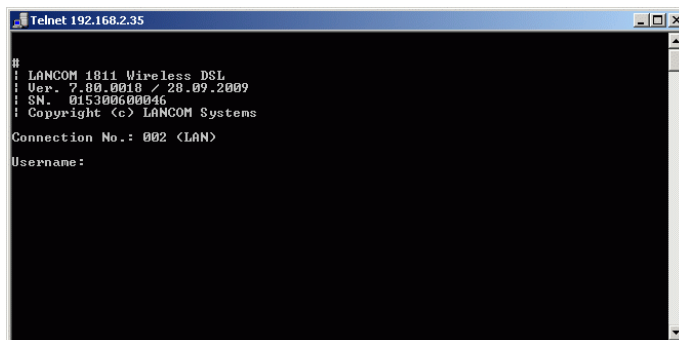
**Open SSH session**

Opens a configuration session with an SSH client.

Extras

Clicking on **Tools > Options** opens up the dialog box for further optional settings. (You can also reach this dialog box by pressing F7).

Options

Under the menu item **Options** you can invoke additional functions, for example to communicate with connected devices, invoke external applications, or carry out automatic searches for firmware updates.

Extras

This dialog window allows you to make **additional settings**.

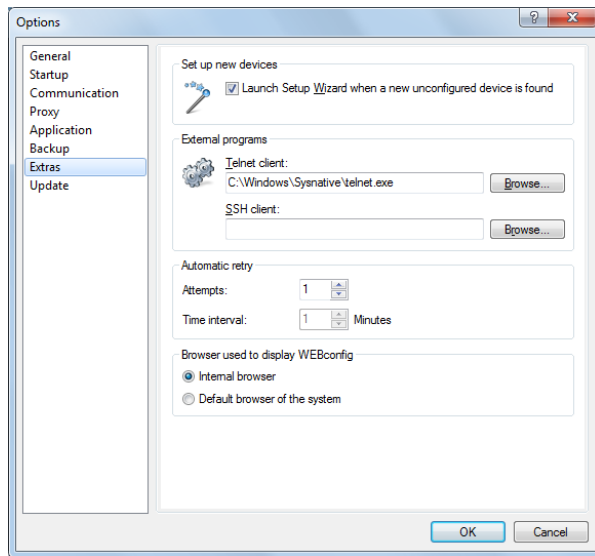

Set up new devices

If this option is checked, LANconfig launches the Setup Wizard whenever it finds an unconfigured device.

External programs

This item specifies the executable files for the Telnet client and the SSH client to be used by LANconfig for connections to the devices.

Automatic retry

Attempts

Specify the number of attempts for a firmware or configuration upload. You can set a number between 1 and 9999. LANconfig always attempts to make a connection. If this fails a retry is attempted after the defined interval. The operation is retried until LANconfig reaches the number of defined attempts or until the operation succeeds. LANconfig may terminate the retries if a situation arises in which completion is unlikely without external intervention. This may be when the device cannot open a file, for example.

Time interval

Enter the time interval in minutes between two attempts to upload the firmware or configuration. You can set an interval between 1 and 9999.

Browser used to display WEBconfig

This item sets the default browser used by LANconfig to display WEBconfig. You can choose between your operating system's default browser and LANconfig's internal browser, LCCEF (LANCOM Chromium Embedded Framework).

3.5 Group configuration with LANconfig

When managing multiple devices it can be very helpful to upload a selection of configuration parameters into a group of devices at once, as opposed to setting each and every parameter manually in the individual devices, e.g. with identical client rights in WLAN access points. Importing complete configuration files is not a viable alternative since device-specific parameters such as the IP address are uploaded as well. Group configuration with LANconfig enables the easy import of partial configuration files and thus makes the simultaneous administration of multiple devices a reality.

The partial configuration files with the common parameters for a group of LANCOM devices are, just like the full configuration files, stored on hard disk or on a server. To aid the configuration of entire groups of devices, links to the partial configuration files are created under LANconfig to provide a convenient connection between the device entries in LANconfig and these partial configuration files.

! Group configuration is supported only by LANCOM devices with a firmware version LCOS 5.00 or higher.

LCOS version 5.00 initially support the group configuration of WLAN devices. Later firmware versions will also support further types of group configuration, such as the VPN parameters. Refer to the LANCOM web site www.lancom.de for more information about the latest firmware versions and the additional possibilities of group configuration.

3.5.1 Create a group configuration

A requirement for working with group configuration to the grouping of devices within folders. These LANconfig folders contain those device entries which are effectively managed by common partial configurations, and the group configurations as links to the partial configuration files.

Group configuration with a new partial configuration file

1. Create a new folder and move the devices that are to be grouped into it with the mouse.
2. Then click on the folder with the right-hand mouse key and select the entry **New group configuration...** from the context menu. After selecting the group type and the firmware version, the LANconfig configuration dialogue opens up with a reduced selection of configuration options.

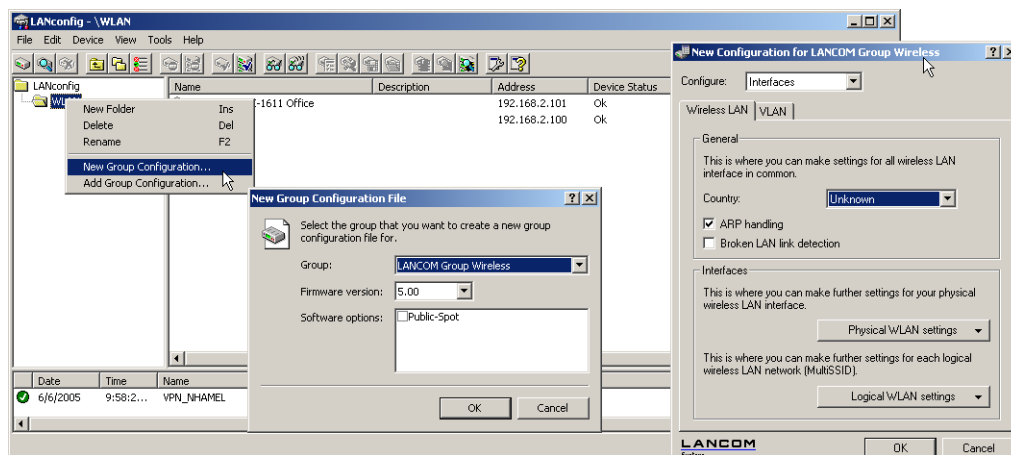

1. The parameters here should be set as required for the entire group. When the configuration dialogue is closed, LANconfig will request that you save the partial configuration file to a location of your choice.

! The group configuration then saves all parameters to a partial configuration file. Those parameters which were not changed are also set to the standard values. Use the scripting function to read out non-standard settings from a device and transfer them to other devices, if required.

- The link to the partial configuration file appears in the list of entries and has the description 'Group Configuration'. The name of the group configuration can be changed via the Properties. To do this, click on the entry with the right-hand mouse key and select **Properties** from the context menu.

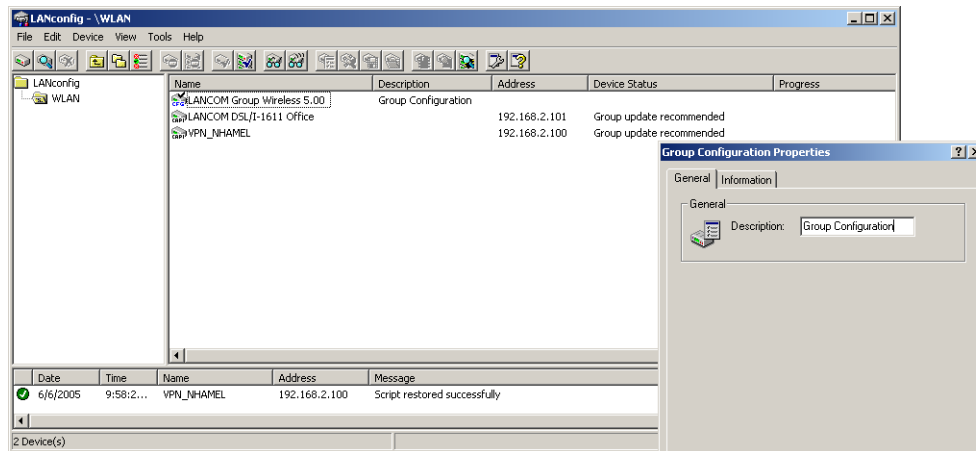

- ! The group configuration is a link to the partial configuration file. Please note that changes to the partial configuration file will lead to changes in that group configuration.

Use an existing partial configuration file

There are cases where it is more effective to use a different folder structure in LANconfig than that required for group configuration. Devices in location-specific folders can indeed be set up with the same group configurations. To avoid having to create the same partial configuration for every folder, links to a common partial configuration file can be created in multiple folders.

- To use an existing partial configuration file for a group configuration, click on the appropriate folder with the right-hand mouse key and select **Add group configuration...** from the context menu.
- In the subsequent dialog, select the existing partial configuration file to create a link to this file in the folder.

- ! Please note that changes to the partial configuration file will lead to changes in that group configuration in various folders.

3.5.2 Update device configurations

By selecting or updating a folder, LANconfig checks the configuration of the devices in this folder for agreement with the settings in the active group configuration. In case of discrepancy from the group configuration, the device status informs that 'Group update recommended'.

3 Configuration and management

To load the group configuration into the WLAN device, drag the group configuration entry onto the appropriate device entry. After successfully transferring the parameters, the device status will change to 'OK'.

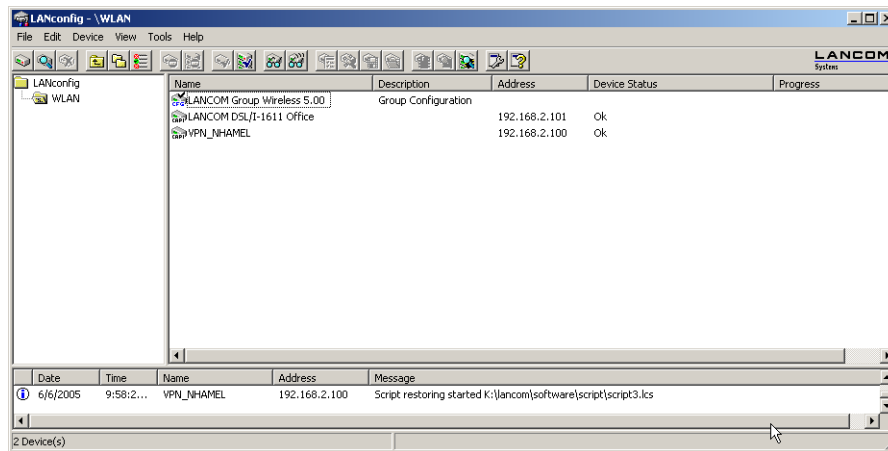

! It is also possible to use the partial configuration for a device as a group configuration. Simply drag the device entry onto the group configuration entry.

3.5.3 Update group configurations

Apart from manually changing the parameters in a group configuration, the current configuration of a device can be used as the basis for a group configuration. One device is thus declared as "Master" for all other devices in the same file.

To take over the values from a current device configuration for a group configuration, simply drag the entry for this device onto the desired group configuration. All of the parameters defined in the group configuration are then overwritten by the values in the device configuration.

The next time that LANconfig checks the devices, it will find that the configurations in the other devices no longer agrees with the new group configuration; this will be displayed by the device status.

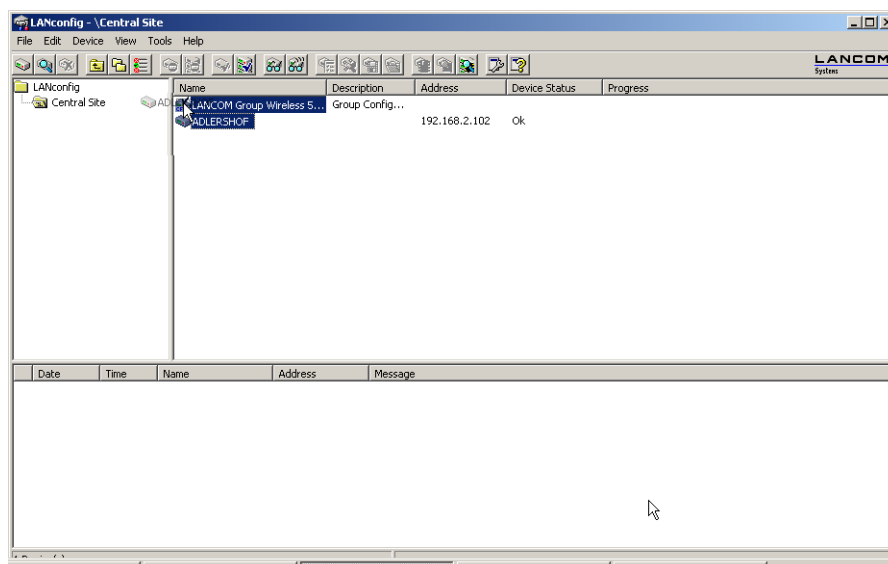

3.5.4 Using multiple group configurations

Multiple group configurations can be created within a single folder. Only one of these group configurations may be active at a time since the device status only relates to **one** group configuration. Active group configurations are indicated

by a blue tick, inactive group configurations are indicated by a red cross. To activate a group configuration, click on the entry with the right-hand mouse key and select **Active** from the context menu. All other group configurations are then deactivated automatically.

! Different group configurations in one folder may not be linked to the same partial configuration file.

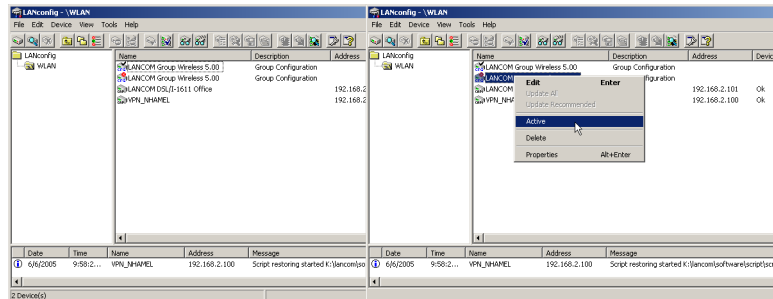

3.5.5 Transferring device configurations to similar models

When changing to a different device type, it is often necessary to adopt aspects of the configuration of the previous model. To do this, LANconfig offers the ability to load the configuration file (*.lcf) of a source device onto a similar destination device. All of the configuration parameters available on both source and destination devices assume the previously used values where possible:

- If the destination device has the appropriate parameter, and the value lies within the possible range, the value of the source device is taken.
- If the value of a parameter available on the destination device is not supported, the default value is used. Example:
 - The source device has four Ethernet interfaces.
 - The destination device only has two Ethernet interfaces.
 - The interface for an IP network is set to LAN-4 on the source device.
 - This value is not supported on the destination device. The value is therefore set to default value "LAN-1" on loading the configuration file.
- All destination-device parameters that were not available on the source device retain their respective values.

Proceed as follows to transfer the configuration onto a new device:

1. The firmware levels of the source and destination devices should be matched as closely as possible. Every new LCOS firmware version features new parameters. Using the same firmware on the two devices allows the greatest possible matching of available parameters.
2. Save the configuration of the source device with LANconfig, e.g. via **Device / Configuration Management / Save as File**.
3. Disconnect the source device from the network to avoid address conflicts.
4. Load the configuration onto the destination device using **Device / Configuration Management / Restore from File**. Messages on the conversion of the configuration are displayed in an information window.

! Please note that this function is intended primarily for replacement devices and not for the configuration of new devices to be operated in parallel with the source device in the same network. Because key communication settings, such as the IP address of the device and DHCP settings, are transferred to the destination device, parallel operation of the source and destination devices in one network may result in conflicts. The configuration of several devices in one network is facilitated by group configuration and configuration via scripts.

3.5.6 Addition(s) to LCOS 8.60

Flexible group configuration with LANconfig

 LCOS version 8.60 offers the full flexibility of the group configuration function.

Flexible group configuration helps you to manage multiple devices: You apply a carefully selected range of configuration parameters to a group of devices, in one go. This is far more convenient than manually setting the parameters in each individual device, e.g. identical SSID settings in WLAN access points. This helps you to avoid transferring complete configuration files from other devices, in which case device-specific parameters such as the IP address are also included. Group configuration with LANconfig enables the simultaneous setting of shared group-configuration parameters, thus facilitating the simultaneous administration of multiple devices.

By collecting multiple devices into a group configuration, these devices can be co-managed as a group. The group configuration files with the common parameters for a group of LANCOM devices are, just like the full configuration files, stored on hard disk or on a server. To aid the configuration of entire groups of devices, links to the group configuration files are created under LANconfig. These links provide a convenient connection between these group-configuration files and the device entries in LANconfig.

LANconfig provides general "group templates" as an aid to creating group configurations. You define which parameters are to be used for a group according to your individual needs. Use this feature to add additional configuration parameters to the group parameters, or to remove the suggested group parameters. You can store the configurations you created either as group configurations or as a customized template for the generation of further group configurations.

 Subsequently you can edit your own group configuration templates, but not the LANconfig basic templates.

The following templates for group configurations are available in LANconfig:

- **LANCOM Group Template WLAN:** Includes the parameters that are co-managed on wireless LAN devices.
- **LANCOM Group Template WLC:** Useful when operating LANCOM WLCs in a cluster, this template includes the full range of parameters that minimize the need for individual device configuration.
- **LANCOM Group Template empty:** Contains no pre-selected group parameters, and so serves as a basis for creating your own group templates which exceed the scope of the WLAN and WLC group templates. Here, the total amount of all available configuration parameters in all device types is available for you to choose those which you want to use for your group configuration.
- **Alternative basic settings:** The LANCOM Group Templates give you the option of including the common parameters for different device types into the group template. However, some parameters overlap between different device types (e.g. DSL and DSLoL). Thus the group templates are always a compromise in which some parameters may be missing. For homogeneous groups containing just one type of device, a specific device configuration with a specific firmware version can be used as the "alternative basic settings" as a template for the group. These basic settings thus allow you to choose from precisely those configuration parameters that are required for this type of device.

Creating a group configuration

To work with group configurations, the devices are collected into folders. These LANconfig folders contain entries for the devices that benefit from the co-management of shared group-configuration parameters and a link to the group configuration.

 A group configuration allows you to manage all device parameters that are shared by the devices in the group. An individual device configuration refers to the parameters that are device specific.

New group configuration file

1. Create a new folder for the devices to be grouped. You have two ways to create this folder:

- Click the right mouse button on an existing folder in the folder view. Select **New folder with group configuration**. The configuration dialog initially creates a new folder as a sub-directory and then continues with the selection of the template to be used for creating a new group configuration.
- In the folder view, click the right mouse button to the directory where you wish to create the new folder. Select the context dialog **New folder** and enter a name. Use the mouse to move the devices for grouping into the new folder. Then click on the folder with the right-hand mouse key and select the context-menu entry **New group configuration**.

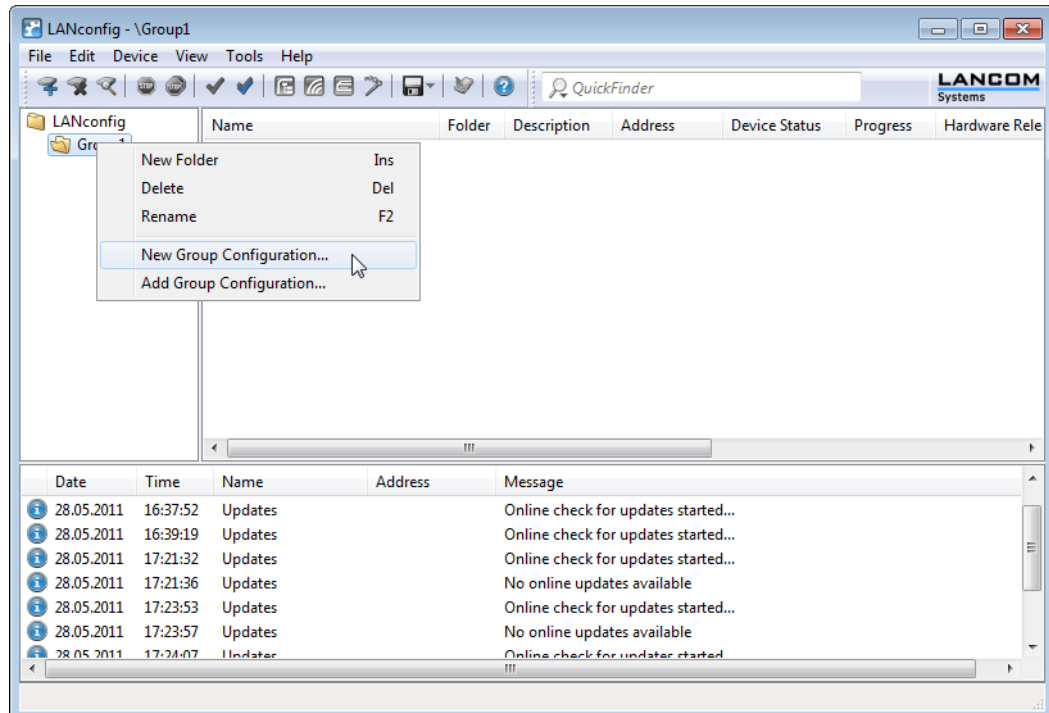

2. Select a template and the appropriate firmware version and click on **OK**.

ⓘ If you have saved your own group templates previously, these will be also displayed in the list of templates.

3. You have the option of selecting the alternative basic settings if you wish to use a specific device type as the basis for the new group configuration. In this case, the new group configuration is created with the default values for the selected device type.

ⓘ In order to avoid inconsistent sets of configuration parameters, the alternative basic settings are based on a blank template corresponding to the "LANCOM Group Template Empty".

4. A configuration dialog opens. Two alternative processing modes are available here. Select this from the list **Group Configuration**:
 - **Edit config. values** mode.
 - **Select group parameters** mode.

3 Configuration and management

- The configuration dialog opens in the **Edit config. values** mode. In this view, you see only the common parameters which are to be co-managed for the group. You can define the required values and content here. Parameters that apply to individual devices are hidden.

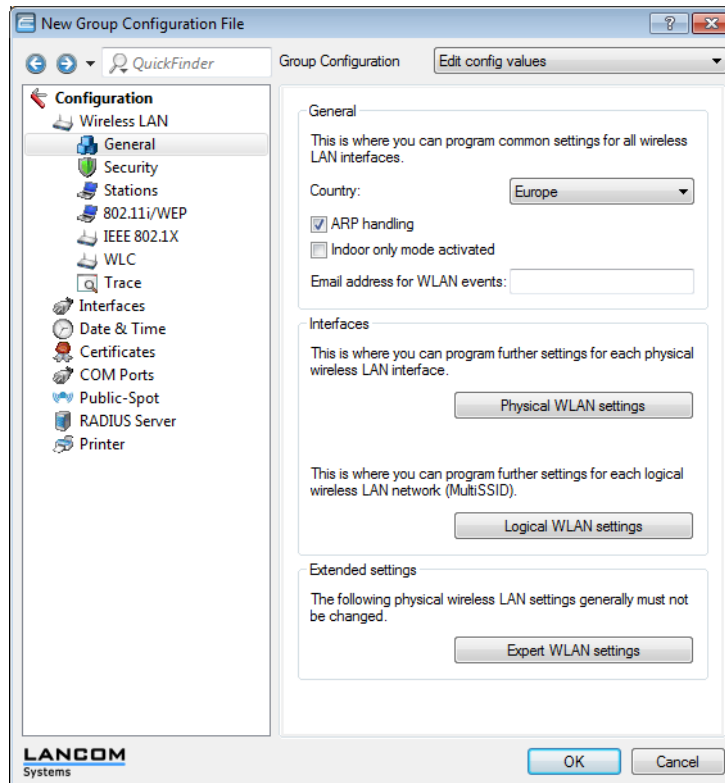

- In the **Select group parameters** mode you can select or de-select all of the parameters that you require for a customized group configuration.

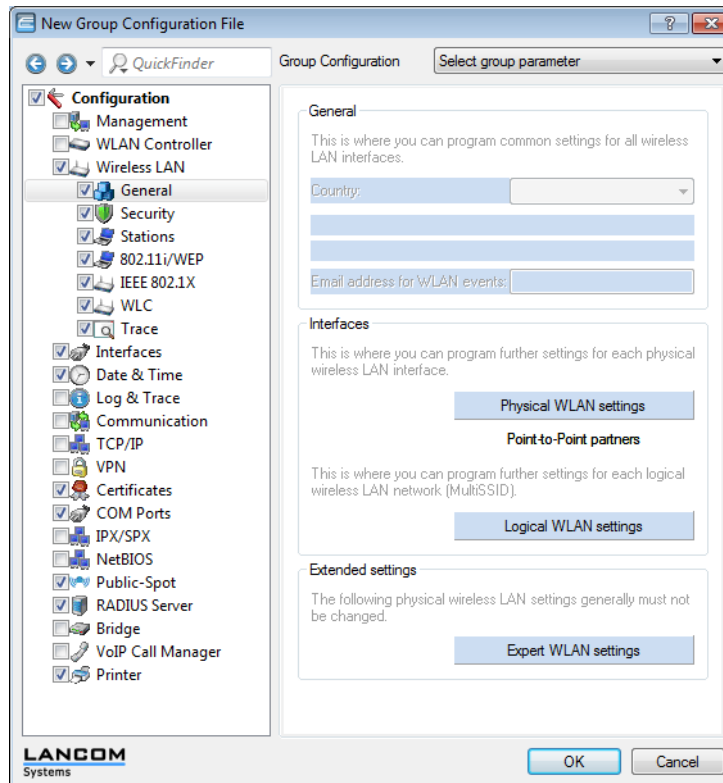

Light-blue colored items are selected for use in the group configuration. Click once with the left mouse button on an item to change its selection status.

Please note the following:

- For tables with statically specified rows (such as interface-related tables and logical WLAN settings) you additionally have the option of transferring individual parameters into the group configuration. You can access some of these parameters in LANconfig via the pull-down menus from buttons.
- For tables with dynamically generated rows (such as the routing table, for example) you can only select or de-select the entire table for the group configuration.
- Similarly, it is only possible to select or de-select the entire firewall for the group configuration.

5. Then click on **OK**.
6. Specify the storage path for the new group configuration. The default directory is the one you specified in **Tools > Options > Backup > Backup path** (default: "\\ config \")

7. As an option you can include this group configuration into the list of templates for creating further group configurations in future. Enable the option **Provide as template** and give the file a descriptive name.

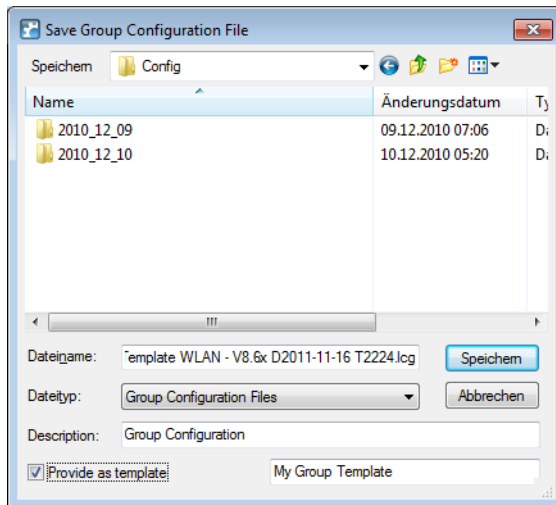

- ! It is also possible to use an existing group configuration to create a template at a later time. Do this by right-clicking on the LANconfig group configuration in the appropriate folder. Then enable the context-menu option **Provide as template** and give the file a descriptive name.

8. Click on **Save** to conclude the action.

- ! The group configuration saves all parameters in a group configuration file, including parameters with preset default values. Use the scripting function to read out only the non-default settings from a device and, if applicable, transfer them to other devices.

The associated group configuration file appears in the list of entries and has the description **Group configuration**. To change the name of the group configuration, access the file's properties. To do this, click on the entry with the right-hand mouse key and select **Properties** from the context menu.

- ! In LANconfig you have the option of creating multiple references to the same group configuration. A change to this effects the devices in all of the folders if a group configuration is assigned to different LANconfig folders.

Using an existing group configuration file

In some cases it may be useful to use a different structure of devices managed with LANconfig than required by the group configuration. For example, devices in different site-specific folders may belong to the same groups. In order to avoid redundant group configuration files for every folder, you may want to create links to a shared file in multiple folders.

To use an existing group configuration file for a group of devices, use the mouse to right-click on the appropriate folder. In the context menu select **Add group configuration**.

In the subsequent dialog, select the existing group configuration file to create a link to this file in the folder.

- ! Please note that changes to the group configuration file will lead to changes in that group configuration in various folders.

If you create additional devices in a group folder, or if you modify an existing group configuration, LANconfig informs you that an update to the appropriate devices is available. This update can be carried out either directly afterwards or at any later time by using the context menu.

Additions to the menu system

Group

Group configurations are managed under the menu item 'Group'.

For further information please refer to section [Flexible group configuration with LANconfig](#).

New group configuration

Under **Group > New group configuration** you create a new group configuration in the current folder.

New folder with group configuration

Under **Group > New folder with group configuration** you create a new sub-folder with a new group configuration in the current folder.

Add group configuration

Under **Group > Add group configuration** you can save an existing group configuration to the active folder. Select the relevant file to do this.

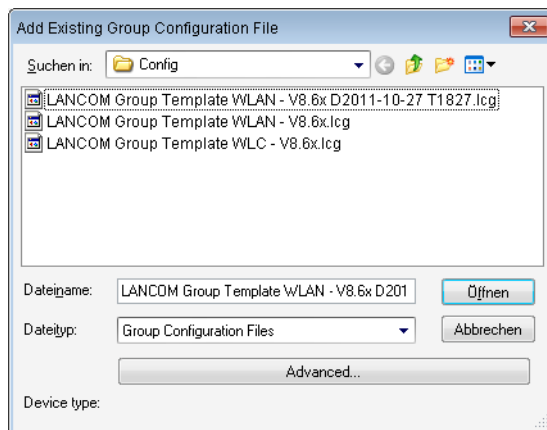

Edit group configuration

Under **Group > Edit group configuration** you have the option to edit the highlighted group configuration.

The parameters set here must be valid for the entire group. When the configuration dialog is closed, LANconfig will request that you save the group configuration file to a location of your choice.

Refresh all devices

Under **Group > Update all devices** you have the option to use the selected and activated group to update all of the devices in the current folder.

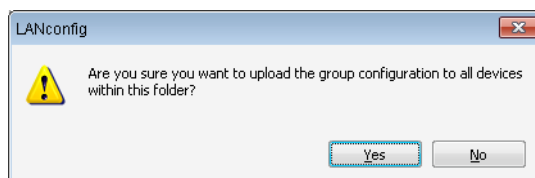

Update recommended devices

Under **Group > Update recommended devices** you have the option to use the selected and activated group to update the recommended devices in the current folder.

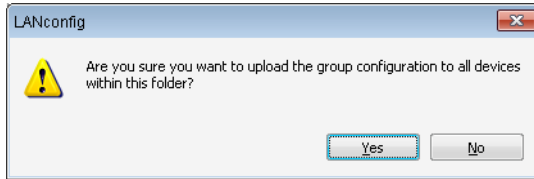

Provide as template

Under **Group > Provide as template** you have the option to set the highlighted group configuration as a template for future group configurations.

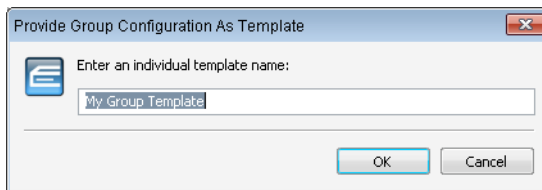

Active

Enable or disable the selected group configuration with the menu item **Group > Active**.

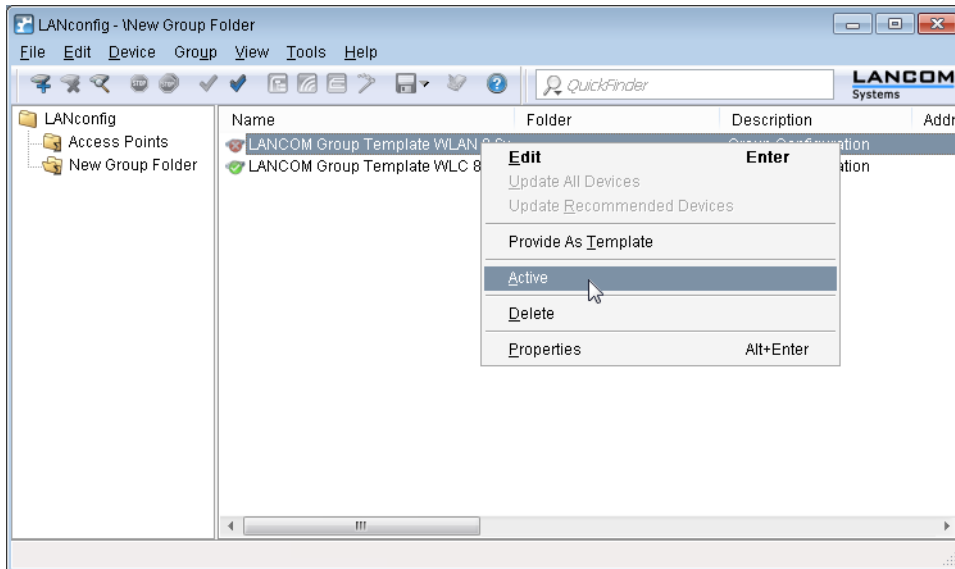

Delete

With **Group > Delete** you can delete the highlighted group configuration.

Features

Under **Group > Properties** you can view information about an existing group configuration. Select the relevant file to do this.

The **General** tab displays the description of the group configuration.

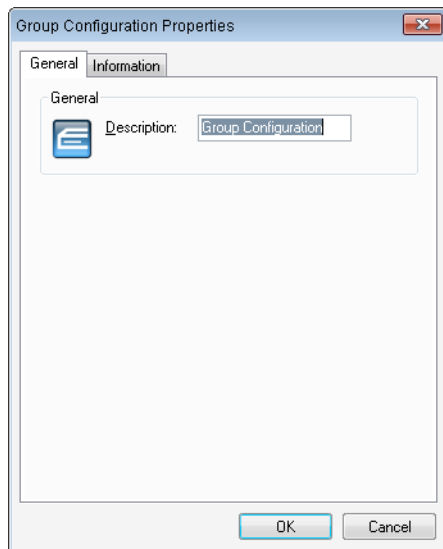

The **Information** tab shows the name, status, and the file name of the group configuration.

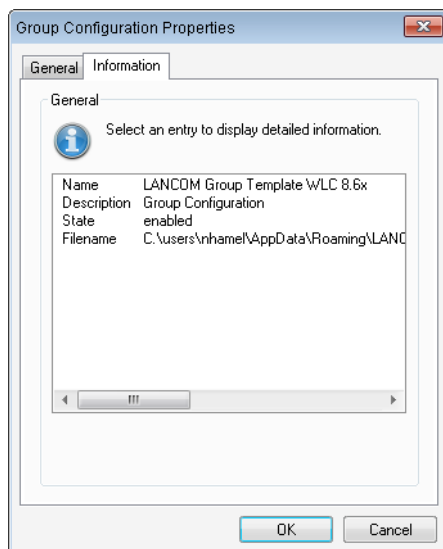

3.6 LANmonitor—know what's going on

The LANmonitor includes a monitoring tool with which you can view the most important information on the status of your routers on your monitor at any time under Windows operating systems—of all of the LANCOM routers in the network.

Many of the internal messages generated by the devices are converted to plain text, thereby helping you to troubleshoot.

! Explanations about the LANmonitor messages and helpful tips can be found in the appendix under .

You can also use LANmonitor to monitor the traffic on the router's various interfaces to collect important information on the settings you can use to optimize data traffic.

In addition to the device statistics that can also be read out during a Telnet or terminal session or using WEBconfig, a variety of other useful functions are also available in LANmonitor, such as the enabling of an additional charge limit.

! With LANmonitor you can only monitor those devices that you can access via IP (local or remote). With this program you cannot access a router via the serial interface.

3.6.1 Extended display options

Under **View / Show Details** you can activate and deactivate the following display options:

- Error messages
- Diagnostic messages
- System information

! Many important details on the status of the LANCOM are not displayed until the display of the system information is activated. These include, for example, the ports and the charge management. Therefore, we recommend that interested users activate the display of the system information.

3.6.2 Enquiry of the CPU and Memory utilization over SNMP

The load on CPU and memory in the LANCOM can be queried with SNMP or displayed in LANmonitor.

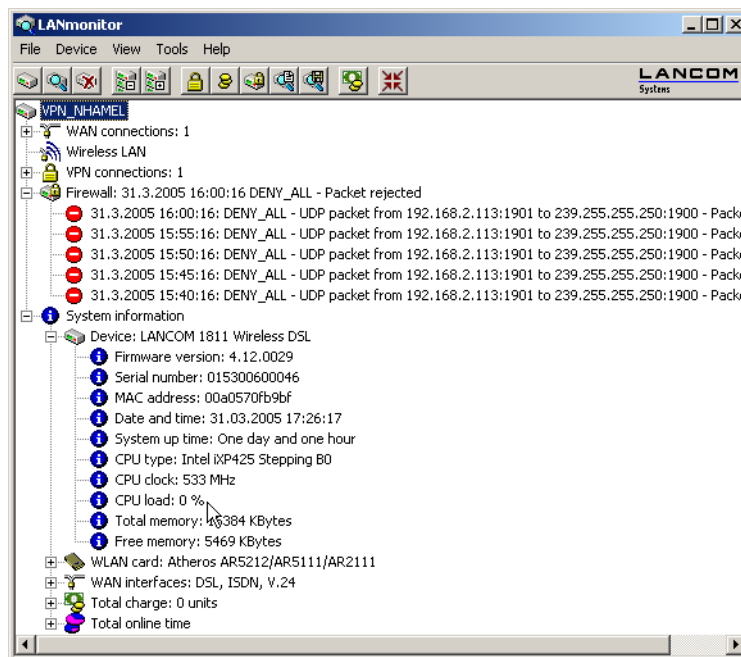

3.6.3 Monitor Internet connection

To demonstrate the functions of LANmonitor we will first show you the types of information LANmonitor provides about connections being established to your Internet provider.

1. To start LANmonitor, go to **Start / Programme / LANCOM / LANmonitor**. Use **File / Add Device** to set up a new device and in the following window, enter the IP address of the router that you would like to monitor. If the configuration of the device is protected by password, enter the password too.

Alternatively, you can select the device via the LANconfig and monitor it using **Device / Monitor Device**.

2. LANmonitor automatically creates a new entry in the device list and initially displays the status of the transfer channels. Start your Web browser and enter any web page you like. LANmonitor now shows a connection being established on one channel and the name of the remote site being called. As soon as the connection is established,

a plus sign against the communication channel entry indicates that further information on this channel is available. Click on the plus sign or double-click the appropriate entry to open a tree structure in which you can view various information

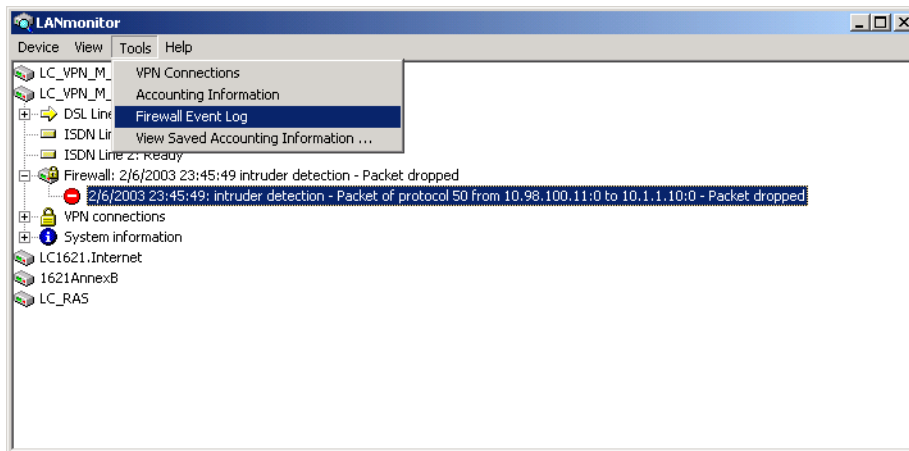

1. In this example, you can determine from the PPP protocol information the IP address assigned to your router by the provider for the duration of the connection and the addresses transmitted for the DNS and NBNS server. Under the general information you can watch the transmission rates at which data is currently being exchanged with the Internet.
2. To break the connection manually, click on the active channel with the right mouse button. You may be required to enter a configuration password.
3. If you would like a log of the LANmonitor output in file form, select **Device / Device Activities Logging** and go to the 'Logging' tab. Open the dialog for the settings for the activity protocol, click on Tools / Options.

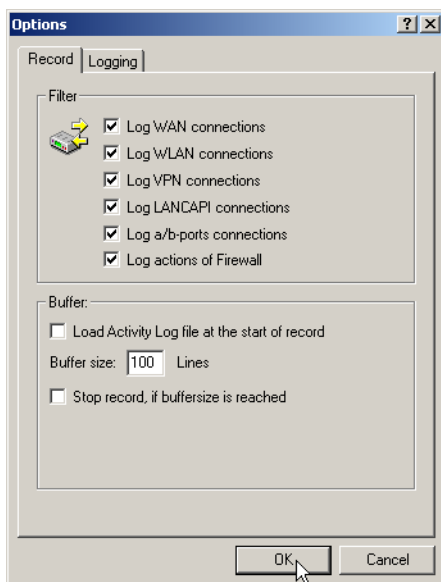

1. On the 'Protocol' tab you can define whether the following activities should be protocolled:
 - WAN connections
 - WLAN connections
 - VPN connections
 - LANCAP connections
 - a/b port connections
 - Firewall actions

You can also specify whether LANmonitor should create a log file daily, monthly, or on an ongoing basis.

3.6.4 Display functions in LANmonitor

LANmonitor supports the administration of the LANCOM applications by offering a range of functions that simplify the surveillance of devices at widely dispersed locations. The overview of devices monitored by LANmonitor already shows the most important information about the status of the devices:

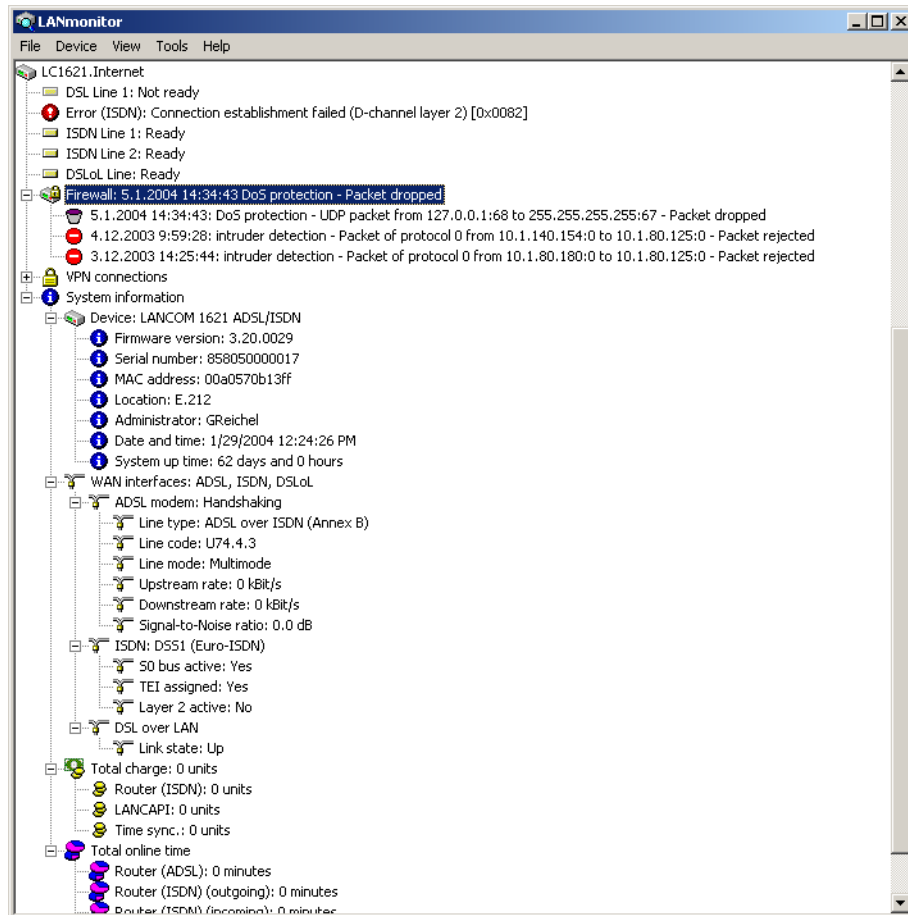

The information that can be taken from the overview includes, among others, details about active WAN connections, the five most recent firewall messages, the current VPN connections and system information about charges and online times.

Right-clicking with the mouse on a device in LANmonitor opens up a context menu with further information:

- VPN connections

The list of VPN connections is a log of the 100 most recent VPN connections. The detailed recorded information includes

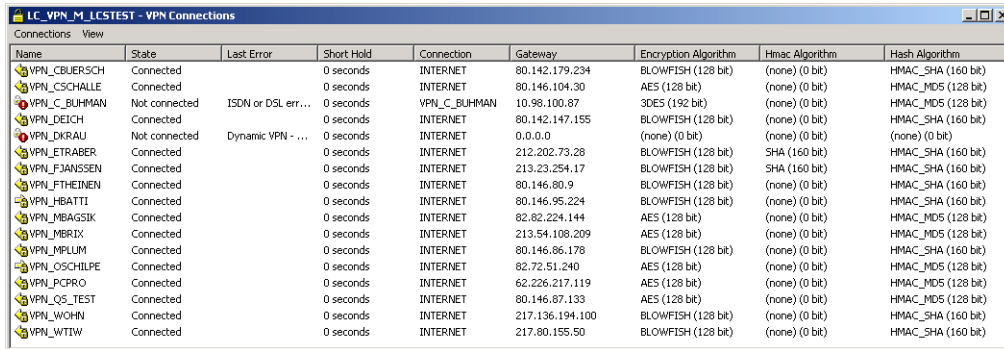

Name	State	Last Error	Short Hold	Connection	Gateway	Encryption Algorithm	Hmac Algorithm	Hash Algorithm
VPN_CBUERSCH	Connected		0 seconds	INTERNET	80.142.179.234	BLOWFISH (128 bit)	(none) (0 bit)	HMAC_SHA (160 bit)
VPN_CSCHALLE	Connected		0 seconds	INTERNET	80.146.104.30	AES (128 bit)	(none) (0 bit)	HMAC_MD5 (128 bit)
VPN_C_BUHMAN	Not connected	ISDN or DSL err...	0 seconds	VPN_C_BUHMAN	10.98.100.87	3DES (192 bit)	(none) (0 bit)	HMAC_MD5 (128 bit)
VPN_DEICH	Connected		0 seconds	INTERNET	80.142.147.155	BLOWFISH (128 bit)	(none) (0 bit)	HMAC_SHA (160 bit)
VPN_DKRAU	Not connected	Dynamic VPN - ...	0 seconds	INTERNET	0.0.0.0	(none) (0 bit)	(none) (0 bit)	(none) (0 bit)
VPN_ETRABER	Connected		0 seconds	INTERNET	212.202.73.28	BLOWFISH (128 bit)	SHA (160 bit)	HMAC_SHA (160 bit)
VPN_FJANSSEN	Connected		0 seconds	INTERNET	213.23.254.17	BLOWFISH (128 bit)	(none) (0 bit)	HMAC_SHA (160 bit)
VPN_FTHEINEN	Connected		0 seconds	INTERNET	80.146.80.9	BLOWFISH (128 bit)	(none) (0 bit)	HMAC_SHA (160 bit)
VPN_HBATTI	Connected		0 seconds	INTERNET	80.146.95.224	BLOWFISH (128 bit)	(none) (0 bit)	HMAC_SHA (160 bit)
VPN_MBAGSIK	Connected		0 seconds	INTERNET	82.82.224.144	AES (128 bit)	(none) (0 bit)	HMAC_MD5 (128 bit)
VPN_MBRIX	Connected		0 seconds	INTERNET	213.54.108.209	AES (128 bit)	(none) (0 bit)	HMAC_MD5 (128 bit)
VPN_MPLUM	Connected		0 seconds	INTERNET	80.146.86.178	BLOWFISH (128 bit)	(none) (0 bit)	HMAC_SHA (160 bit)
VPN_OSCHILPE	Connected		0 seconds	INTERNET	82.72.51.240	AES (128 bit)	(none) (0 bit)	HMAC_MD5 (128 bit)
VPN_PCPRO	Connected		0 seconds	INTERNET	62.226.217.119	AES (128 bit)	(none) (0 bit)	HMAC_MD5 (128 bit)
VPN_QS_TEST	Connected		0 seconds	INTERNET	80.146.87.133	AES (128 bit)	(none) (0 bit)	HMAC_MD5 (128 bit)
VPN_WOHN	Connected		0 seconds	INTERNET	217.136.194.100	BLOWFISH (128 bit)	(none) (0 bit)	HMAC_SHA (160 bit)
VPN_WTIW	Connected		0 seconds	INTERNET	217.80.155.50	BLOWFISH (128 bit)	(none) (0 bit)	HMAC_SHA (160 bit)

- Name of the remote device
- Current status
- Last error message
- IP address of the gateway
- Encryption information
- Accounting information

The accounting information is a protocol of the connections from each station in the LAN to remote sites in the WAN. The detailed information recorded includes

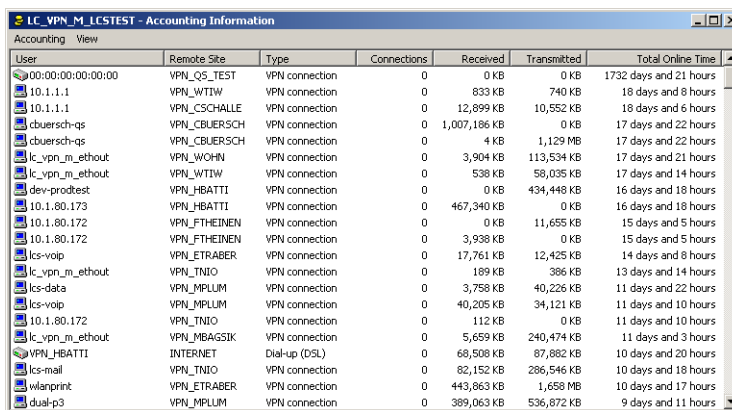

User	Remote Site	Type	Connections	Received	Transmitted	Total Online Time
00:00:00:00:00:00	VPN_QS_TEST	VPN connection	0	0 KB	0 KB	1732 days and 21 hours
10.1.1.1	VPN_WTIW	VPN connection	0	833 KB	740 KB	18 days and 8 hours
10.1.1.1	VPN_CSCHALLE	VPN connection	0	12,899 KB	10,552 KB	18 days and 6 hours
cbuersch-qs	VPN_CBUERSCH	VPN connection	0	1,007,186 KB	0 KB	17 days and 22 hours
cbuersch-qs	VPN_CBUERSCH	VPN connection	0	4 KB	1,129 MB	17 days and 22 hours
lc_vpn_m_ethout	VPN_WOHN	VPN connection	0	3,904 KB	113,534 KB	17 days and 21 hours
lc_vpn_m_ethout	VPN_WTIW	VPN connection	0	538 KB	58,035 KB	17 days and 14 hours
dev-prodttest	VPN_HBATTI	VPN connection	0	0 KB	434,448 KB	16 days and 18 hours
10.1.80.173	VPN_HBATTI	VPN connection	0	467,340 KB	0 KB	16 days and 18 hours
10.1.80.172	VPN_FTHEINEN	VPN connection	0	0 KB	11,655 KB	15 days and 5 hours
10.1.80.172	VPN_FTHEINEN	VPN connection	0	3,938 KB	0 KB	15 days and 5 hours
lcs-voip	VPN_ETRABER	VPN connection	0	17,761 KB	12,425 KB	14 days and 8 hours
lc_vpn_m_ethout	VPN_TNIO	VPN connection	0	189 KB	386 KB	13 days and 14 hours
lcs-data	VPN_MPLUM	VPN connection	0	3,758 KB	40,226 KB	11 days and 22 hours
lcs-voip	VPN_MPLUM	VPN connection	0	40,205 KB	34,121 KB	11 days and 10 hours
10.1.80.172	VPN_TNIO	VPN connection	0	112 KB	0 KB	11 days and 10 hours
lc_vpn_m_ethout	VPN_MBAGSIK	VPN connection	0	5,659 KB	240,474 KB	11 days and 3 hours
VPN_HBATTI	INTERNET	Dial-up (DSL)	0	68,508 KB	87,882 KB	10 days and 20 hours
lcs-mail	VPN_TNIO	VPN connection	0	82,152 KB	286,546 KB	10 days and 18 hours
wlangprint	VPN_ETRABER	VPN connection	0	443,863 KB	1,658 MB	10 days and 17 hours
dual-p3	VPN_MPLUM	VPN connection	0	389,063 KB	536,072 KB	9 days and 11 hours

- Name or IP address of the station
- Remote station used to establish the connection
- Type of connection, e.g. DSL or VPN
- Number of connections
- Data volume sent and received
- Online time
- Activity log

3 Configuration and management

The activity log is a detailed list of the connections via WAN, WLAN, VPN, LANCAPI and a/b port, and a list of firewall activities. The detailed information recorded includes

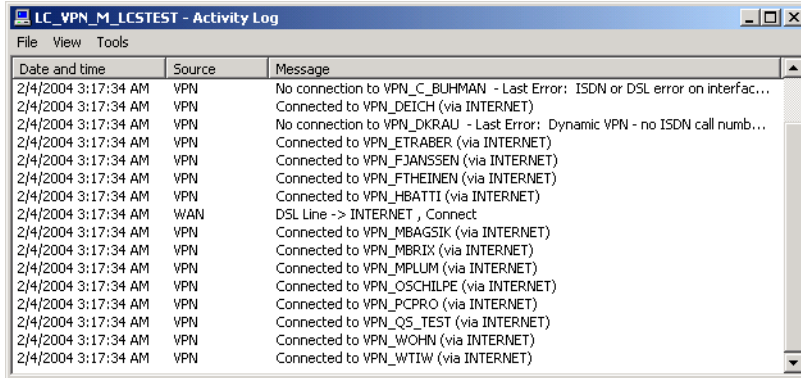

- Date and time
- Source
- Message
- Firewall actions log

The firewall actions log lists the last 100 actions taken by the firewall. The detailed information recorded includes

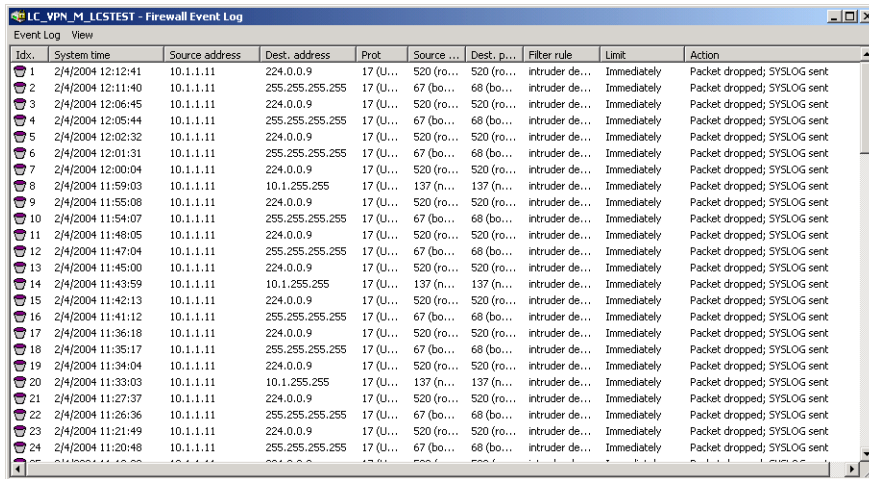

- Time
- Source and destination address
- Protocol with source and destination port
- Activated filter rule and exceeded limit
- Action carried out

3.6.5 Connection diagnosis with LANmonitor

LANmonitor can be used to check the connection quality between stations in the LAN, WAN or WLAN. LANmonitor sends pings from the computer on which it is installed to the remote site at regular intervals. The responses it receives are the basis for a compiled report.

To enter the parameters and display the results, a dedicated dialog has been implemented in LANmonitor.

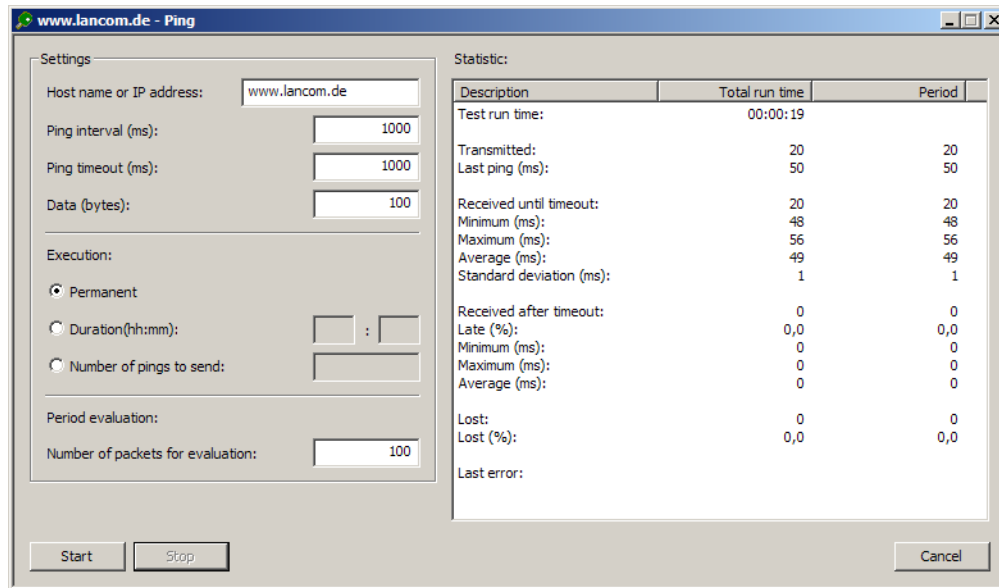

LANmonitor: Tools / Ping... or via the context menu

Configuring Ping execution

- Host name or IP address

The remote station which is to be queried by Ping is entered here. The following information can be entered for all of the different network devices (servers, clients, routers, printers, etc.) which can be reached via LAN, WAN or WLAN.

! If a device is selected when the Ping dialog is opened with **Device / Ping...** or via the context menu in LANmonitor, then the IP address of this device is assumed to be the remote site.

- Ping interval

The time interval between two consecutive pings in [ms].

! The interval between two pings cannot be less than the packet transmission time, i.e. before sending a ping, the previous ping must have been answered or the ping timeout must have expired.

- Ping timeout

The time waited for the response to a ping to arrive [ms]. If this time expires and no response was received then the ping is assumed to be lost.

- Data

The size of a ping packet [bytes]. A "ping" is an ICMP packet which is generally transmitted without any content, i.e. it is just a header. To increase the load of the packets used for testing a connection, a payload can be created artificially. The overall packet size then consists of an IP header (20 bytes), an ICMP header (8 bytes) and the payload.

! The packets will be fragmented if the payload of the ICMP packets exceeds the maximum IP packet size.

- Execution

Repeat mode for the ping command.

Evaluation

The right-hand portion of the Ping dialog displays the results of the ping test. The first column shows the sum values over the entire test; the second column shows only the values collected over the evaluation period, i.e. the sum of the most recent packets. Unanswered pings are not included in the evaluation.

 The period evaluation considers only the pings sent during the defined period.

The following information is displayed for evaluation:

- Test run time
 - The total run time [hr./ min./ sec.]
- Transmitted
- Total number of pings sent
 - Run time of the last ping [ms]
- Received until timeout
 - The number of pings answered in the timeout period
 - Minimum runtime
 - Maximum runtime
 - Average
 - Standard deviation from the mean run time
- Received after timeout
 - The number of pings answered after the timeout period
 - Late packets as a proportion of the total number
 - Minimum runtime
 - Maximum runtime
 - Average
- Lost
 - The number of lost packets
 - Lost packets as a proportion of the total number

3.6.6 Addition(s) to LCOS 7.70

Setting up point-to-point connections with LANmonitor

To find the best possible alignment for point-to-point connection antennas, the current signal quality over a P2P connection can be displayed on the device's LEDs or in LANmonitor. LANmonitor provides not only an optical display of link strength, but an acoustic signal as well.

In LANmonitor the connection quality display is opened with the context menu. Right-clicking with the mouse on 'Point-to-point' activates the option 'Adjusting Point-to-Point WLAN Antennas...'

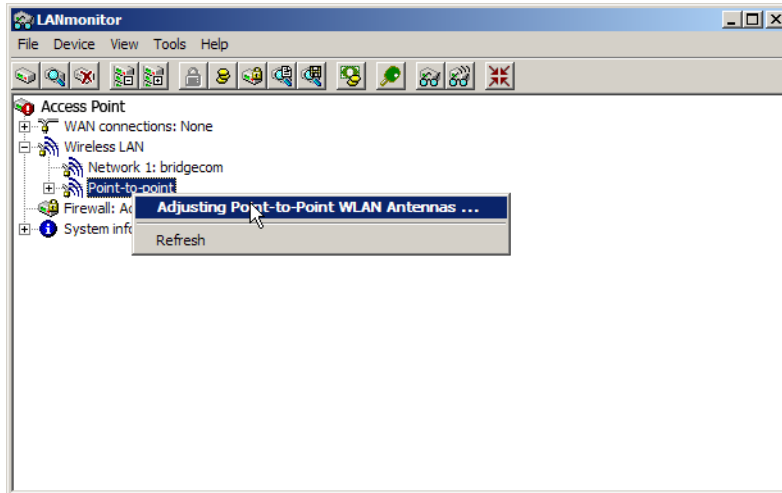

Once signal monitoring has commenced, the P2P dialog displays the absolute values for the current signal strength and the maximum value since starting the measurement. The development of the signal strength over time and the maximum value are displayed in a diagram, too.

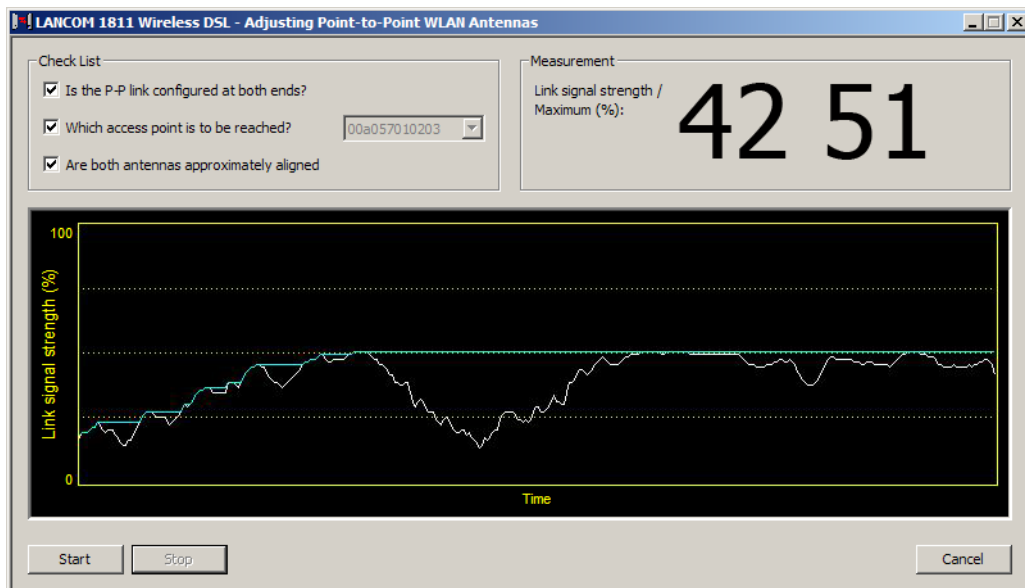

Initially only one of the two antennas should be adjusted until a maximum value is achieved. This first antenna is then fixed and the second antenna is then adjusted to attain the best signal quality.

An acoustic signal can be activated to help align the antennas precisely. With this option, the PC can emit a tone which varies according to signal strength. Maximum signal strength over the link is signaled by a constant tone. If the signal strength drops below the maximum, tones are emitted at intervals indicating the difference from the former maximum. The shorter the interval, the closer the current link signal strength is to the maximum.

Performance monitoring with LANmonitor

LANmonitor logs various parameters in the devices and displays these graphically:

- Transmit and receive rates for WAN connections
- Transmit and receive rates for point-to-point connections

3 Configuration and management

- Signal reception strength for point-to-point connections
- Link signal strength for point-to-point connections
- Throughput for point-to-point connections
- CPU load
- Free memory
- Temperature (not available on all models)

LANmonitor displays the current values directly in the corresponding groups.

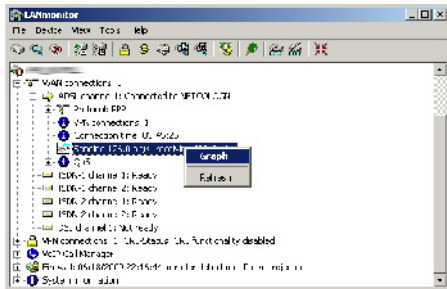

A click on the **Graph** item in the context menu opens a new window which displays these parameters over time.

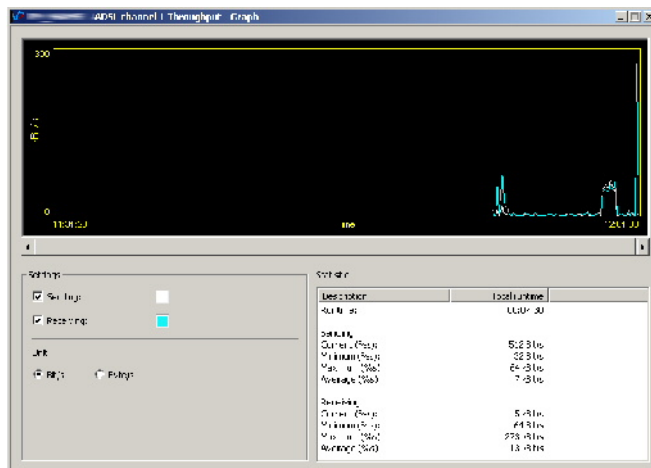

You can use the left-hand mouse key to mark any period in the graph, and these statistical values will be displayed separately.

This dialog displays the values collected over the last 24 hours.



Please note that the values on display are deleted when the dialog is closed. For monitoring over a longer period, leave the window open.

3.6.7 Addition(s) to LCOS 7.80

Averaging of CPU-load display

Introduction

The current CPU load for the device can be output in various ways (LANmonitor, WEBconfig, or CLI in the status area; some models have an integrated display).

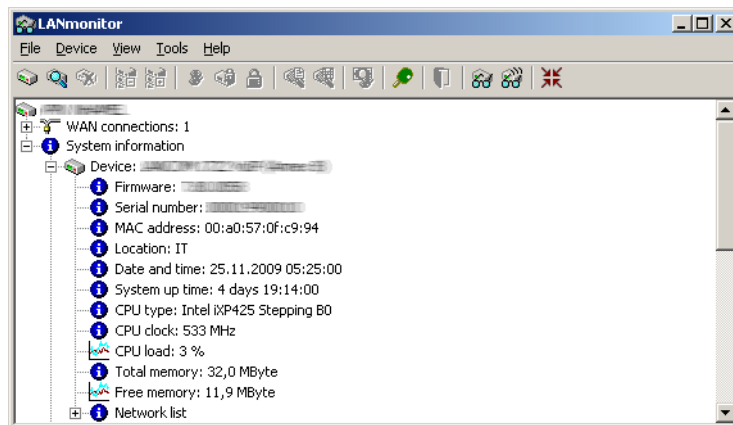

Configuration

You can set the time interval for averaging the value for the displayed CPU load.

WEBconfig: LCOS menu tree / Setup / Config

- CPU-load interval

You can select the time interval for averaging the CPU load. The CPU load displayed in LANmonitor, in the status area, in the display (if fitted), or by SNMP tools is a value which is averaged over the time interval set here. The status area under WEBconfig or CLI additionally display the CPU load values for all four of the optional averaging periods.

Possible values:

- 1, 5, 60 or 300 seconds.

Default:

- 60 seconds.



The default period of 60 seconds is specified by the HOST-RESOURCES-MIB, which is used by many SNMP tools to display CPU load in a tacho display. Please consider this specification when altering the CPU-load interval.

Hardware-Info	
Board-Revision	A
CPU-Clock-MHz	533
CPU-Load-1s-Percent	3
CPU-Load-300s-Percent	3
CPU-Load-5s-Percent	7
CPU-Load-60s-Percent	3
CPU-Load-Percent	3
CPU-Type	Intel iXP425 Stepping B0
Ethernet-Switch-Type	88E6060 Rev. 2
Free-Memory-KBytes	11586
Model-Number	LANCOM 1722 VoIP (Annex B)
Serial-Number	000019900010
SW-Version	7.80.0058 / 18.11.2009
Temperature-Degrees	51
Total-Memory-KBytes	32768
VPN-HW-Accelerator	Yes

3.6.8 Addition(s) to LCOS 8.50

Monitoring the input voltage for universal power adapters

Some devices feature a universal power adapter for two-pin industrial connectors, which caters for variable power supply voltages of 10 – 28 volts.

To avoid a failure or damage to the device, these models monitor and the voltage and report over- and undershooting of the allowed voltage range.

The displayed voltage is the actual momentary input voltage at the integrated universal power adapter. The input voltage can have a minimum value of 10 volts and a maximum value of 28 volts. If input voltage over- or undershoots the allowable range, the device reports the error via SNMP trap and as a SYSLOG message. Furthermore, LANmonitor logs these states to the device activity list. In such cases you should quickly ensure that the permissible input voltage is supplied again.

! Configure the necessary SYSLOG server or SNMP manager in the device to ensure that messages are sent to the appropriate monitoring systems.

Display in LANmonitor

LANmonitor displays the current input voltage in the System Information section:

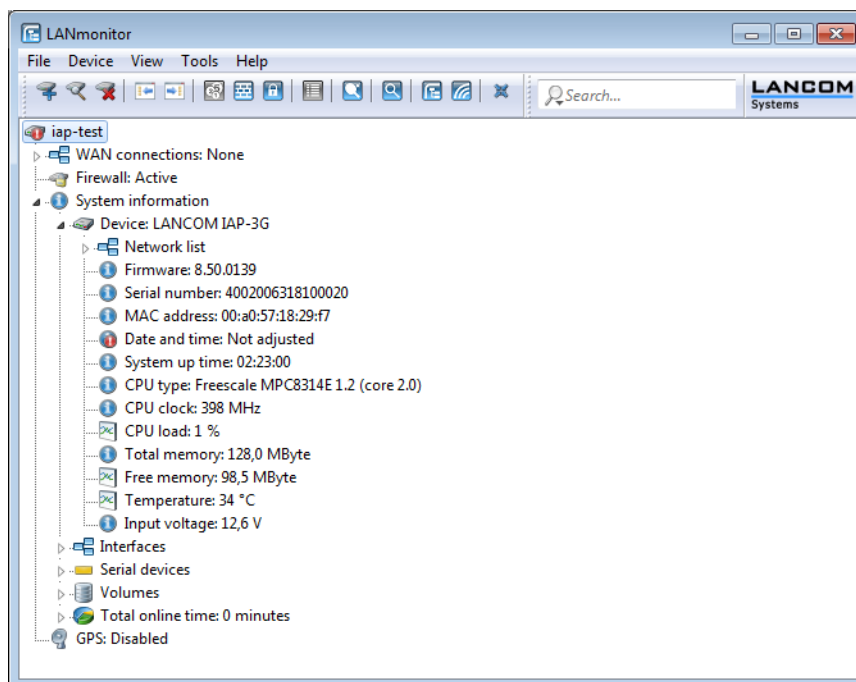

In the case of overvoltage or undervoltage, LANmonitor displays a warning symbol for the input voltage:

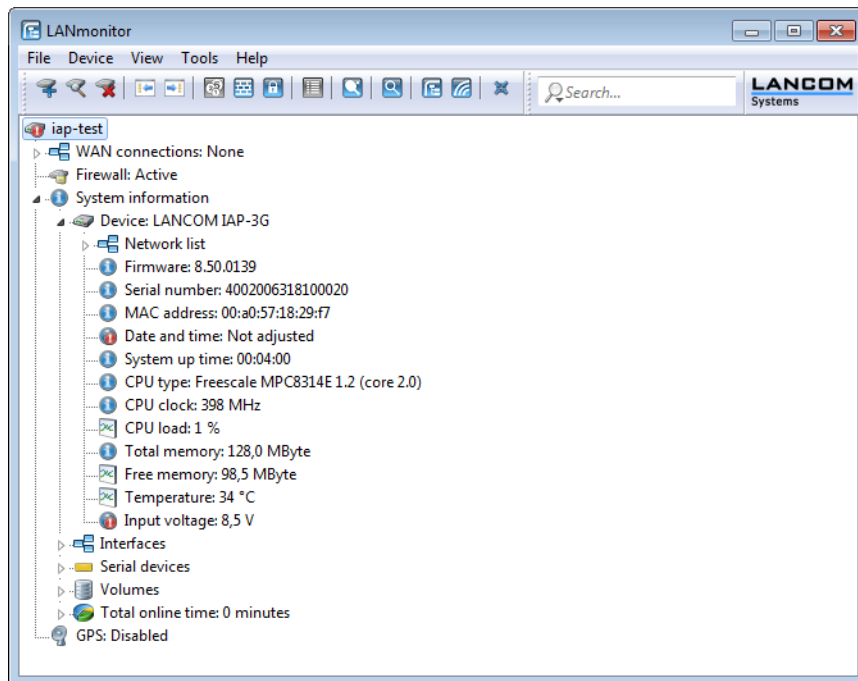

Display in Webconfig

Webconfig displays the current input voltage in the section Hardware Info (Status > Hardware Info > Wide-Range-Power-Supply-mV):

Hardware-Info	
Security-Unit	
PCI-Clocks	4 x [Host-Bridge,Bus,Clock-kHz]
PCI-Device-List	32 x [Host-Bridge,Bus,Device,Function,Type,Device-ID,Subsystem-ID,...]
Board-Revision	A
CPU-Clock-MHz	398
CPU-Load-1s-Percent	2
CPU-Load-300s-Percent	1
CPU-Load-5s-Percent	2
CPU-Load-60s-Percent	1
CPU-Load-Percent	1
CPU-Type	Freescale MPC8314E 1.2 (core 2.0)
Free-Memory-KBytes	97982
Model-Number	LANCOM IAP-321-3G
Security-Engine	Yes
Serial-Number	4002061118100002
SW-Version	8.50.0142 / 12.07.2011
Temperature-Degrees	36
Total-Memory-KBytes	131072
Wide-Range-Power-Supply-mV	8785

SNMP traps

Devices with a universal power adapter report the over- and undershooting of the permitted input voltage range with the following SNMP traps:

- TRP_VOLTMON_OVERVOLT (4500): This trap indicates that the current input voltage exceeds the permissible range.

3 Configuration and management

- TRP_VOLTMON_NO_OVERVOLT (4501): This trap indicates that the input voltage exceeded the permissible maximum voltage and has returned to the permissible range.
- TRP_VOLTMON_UNDERVOLT (4502): This trap indicates that the current input voltage is below the permissible range.
- TRP_VOLTMON_NO_UNDERVOLT (4503): This trap indicates that the input voltage fell below the permissible minimum voltage and has returned to the permissible range.

! Configure the necessary SNMP manager in the device to ensure that messages are sent to the appropriate monitoring systems.

SYSLOG messages

Devices with a universal power adapter report the over- and undershooting of the permitted input voltage range with the following SYSLOG messages:

- Voltage above the permissible range: <current input voltage>: This SYSLOG message indicates that the current input voltage exceeds the permissible range.
- Voltage within the permissible range: <current input voltage>: This trap indicates that the input voltage exceeded or fell below the permissible voltage range and has returned to the permissible range again.
- Voltage below the permissible range: <current input voltage>: This SYSLOG message indicates that the current input voltage is below the permissible range.

! Configure the necessary SYSLOG server in the device to ensure that messages are sent to the appropriate monitoring systems.

Show the current protocol for the ADSL interface

For devices with integrated ADSL modem, LANmonitor's system information displays the ADSL standard currently being used.

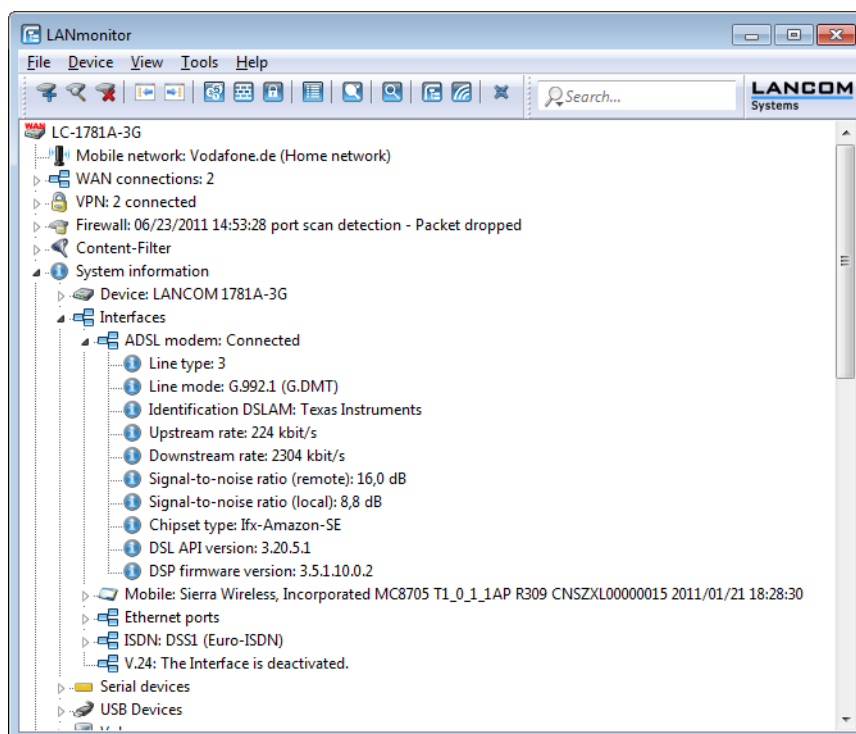

3.6.9 Addition(s) to LCOS 8.80

Display local IPv6 addresses

As of LCOS version 8.80, LANmonitor can display the IPv6 addresses of local networks. This display function is available in various places within the menu.

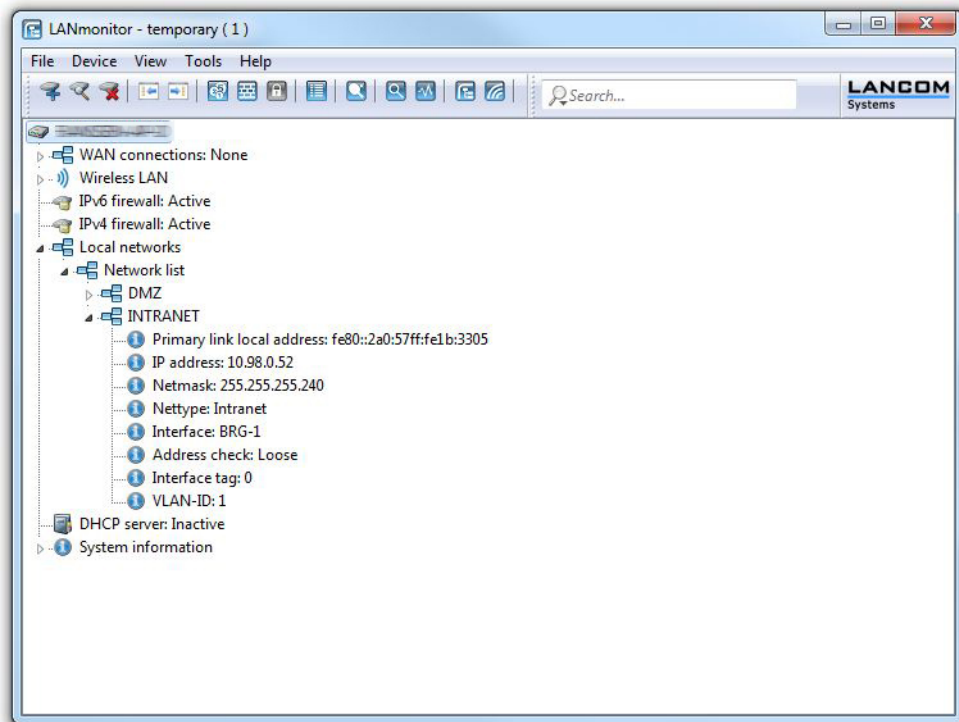

Displaying PBX lines in the SIP ALG

As of LCOS version 8.80, LANmonitor displays the PBX lines separately with the registration method **Options** in the section **SIP ALG > Registrations**.

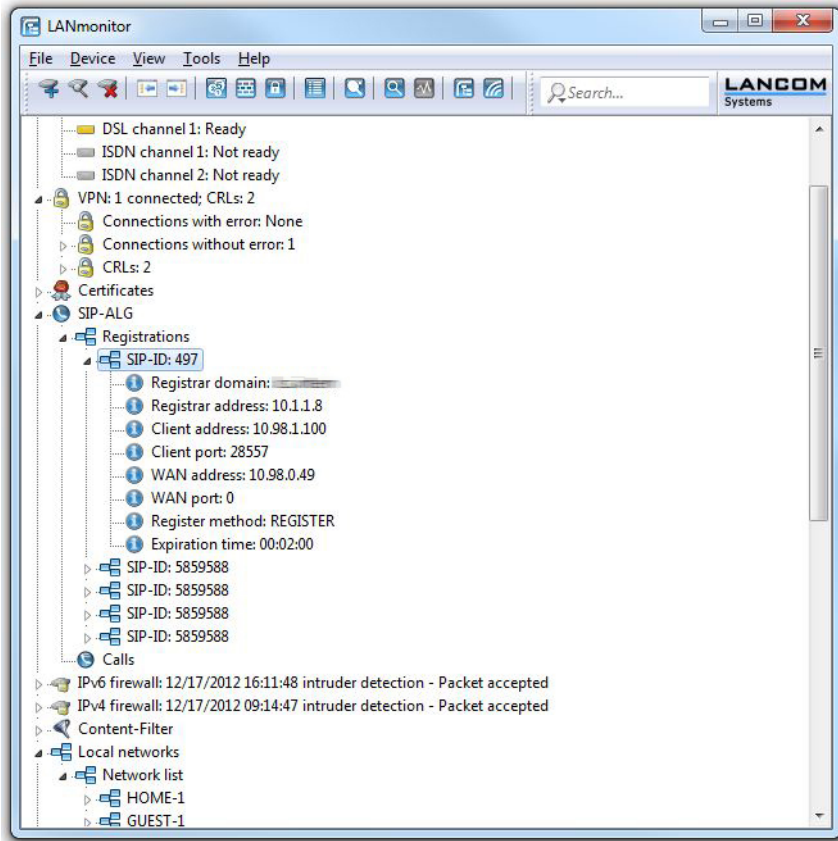

Displaying the active Ethernet ports

As of LCOS version 8.80, LANmonitor allows you to display the operating status of the Ethernet ports.

The menu item **System information > Interfaces > Ethernet ports** shows whether ports are in operation and, if so, which network the port is assigned to (e.g. LAN-1 after the port name).

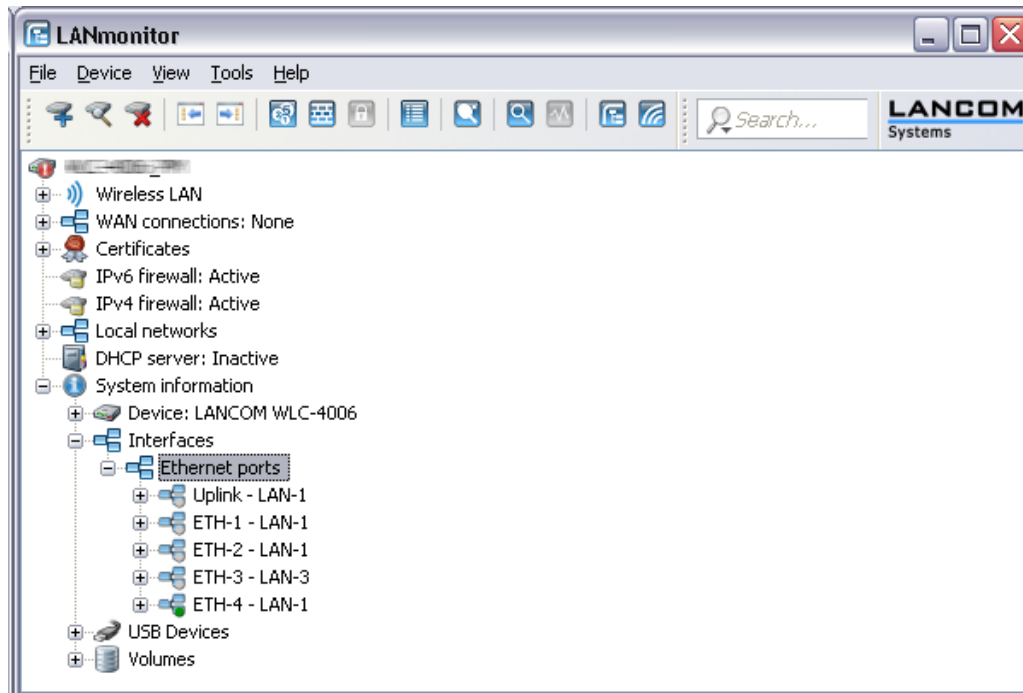

Displaying the DHCP assignment

As of LCOS version 8.80, the LANmonitor menu item **DHCP server** displays the connection status of the individual DHCP clients by the color of the corresponding device icon.

- A blue icon shows DHCP clients which are active in the network.
- A gray icon shows DHCP clients which are not currently active in the network (e.g. switched off or disconnected), but which still have a valid DHCP assignment.

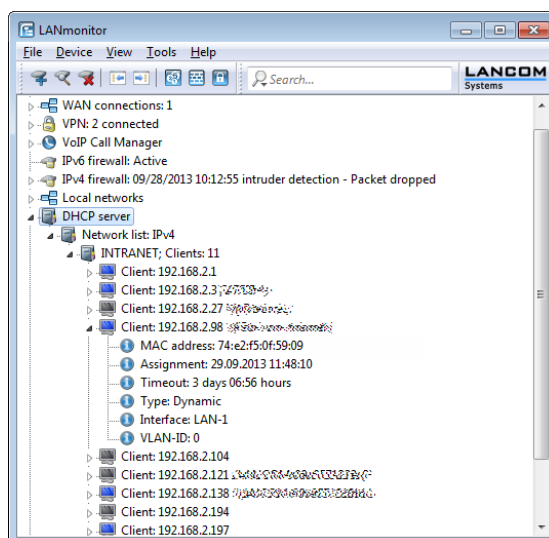

! DHCP clients for some operating systems such as Android do not submit a device name. In this case, LANmonitor displays the MAC address of the DHCP client only. This behavior may be undesirable with a large number of

3 Configuration and management

clients. To display a device name in these cases, enter the MAC address of the DHCP client with the desired device name into the BOOTP table on the DHCP server.

Delete all VPN connection failures

As of LCOS version 8.80, LANmonitor gives you the option of deleting all of the VPN connection errors with just one click.

To do this, navigate to the area of LANmonitor for VPN connections, right-click on the entry **Connections with error:** x and select **Clear all VPN connection errors**.

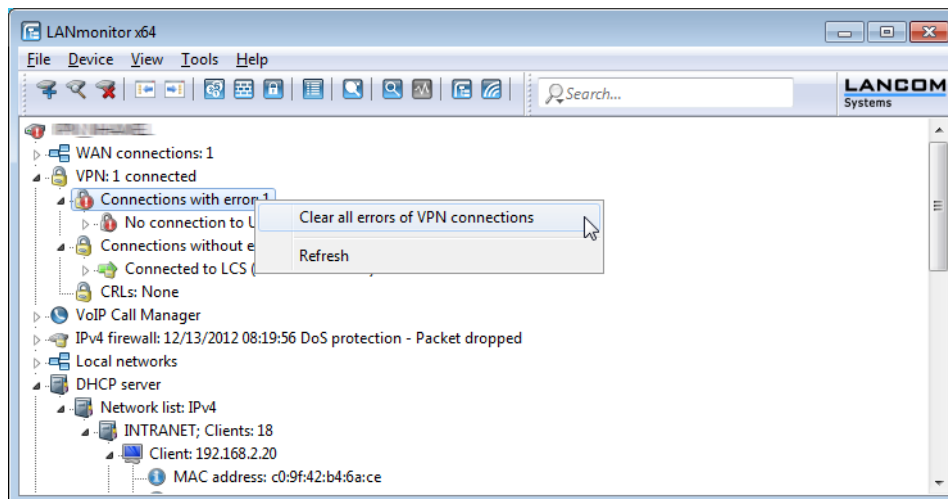

Display of the GPS time

As of LCOS version 8.80, LANmonitor gives you the option to display the time received from the GPS network.

Navigate to the **GPS** section for the device in LANmonitor. The current GPS time is displayed under **Timestamp**.

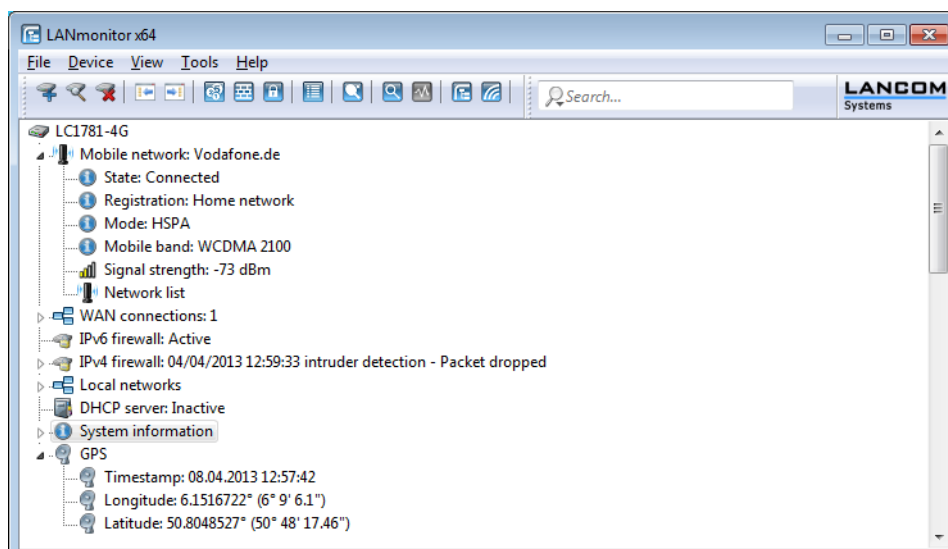

3.7 Visualization of larger WLANs with WLANmonitor

With LANCOM WLANmonitor you can centrally monitor the status of a wireless network (WLAN). It presents information about the entire network in general and detailed information about individual access points and logged-in clients. LANCOM WLANmonitor can also collect access points into groups. These groups may consist of access points gathered in buildings, departments, or at particular locations. In particular with large WLAN infrastructures, this helps to keep an overview of the entire network.

3.7.1 Start the LANCOM WLANmonitor

WLANmonitor is a component of LANmonitor. Start WLANmonitor from LANmonitor using the menu item **Tools / WLANmonitor**, by using the corresponding button in the LANmonitor button bar or directly with **Start / Programme / LANCOM / WLANmonitor**.

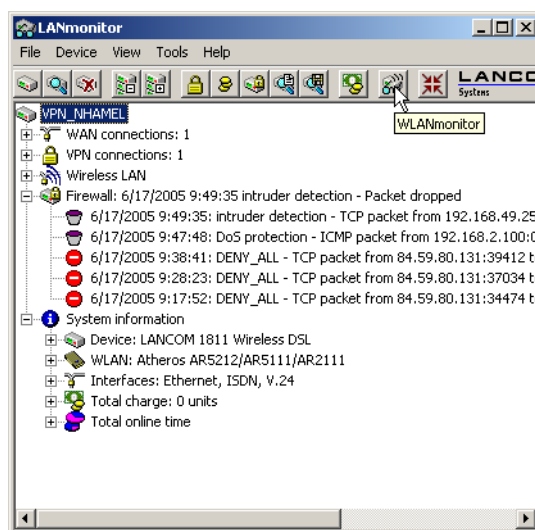

Alternatively, WLANmonitor can be started from the console with the command

- `[installation path]lanmon -wlan`

3.7.2 Search for access points

After starting WLANmonitor, commence a search for available access points via the menu item **File / Find access points**. The access points found are listed in the middle column. Also shown here is the main information for each access point such as the name, number of registered clients, the frequency band and channels being used.

- Name of the access point
- Number of the connected clients
- Used frequency band
- Used channel
- IP address of the access point

The right-hand column (client list) lists the clients that are logged in to the selected access point. The following information is shown for each client:

- Connection quality as a bar chart
- Identification: The name of the logged-in client in as far as this is entered into the access list or a RADIUS server.

LANconfig: WLAN Security / Stations / Stations

3 Configuration and management

Telnet: Setup/WLAN/Access-List

WEBconfig: LCOS menu tree / Setup / WLAN E Access-List

- Signal: Connection signal strength
- Access point: Name of the access point that the client is logged on to
- SSID: Identifier for the WLAN network
- Encryption: Type of encryption used for the wireless connection
- WPA version (WPA-1 or WPA-2)
- MAC address: Hardware address of the WLAN client
- TX rate: Transmission data rate
- RX rate: Reception data rate
- Last event, e.g. 'Authentication successful', 'RADIUS successful'
- IP address of the WLAN clients

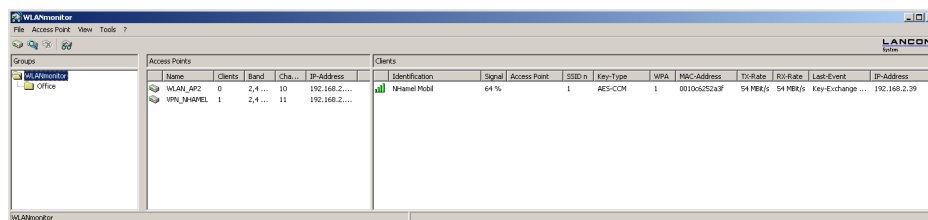

Groups		Access Points				Clients											
		Name	Clients	Band	Ch...	IP-Address	Identification	Signal	Access Point	SSID n...	Key-Type	WPA	MAC-Address	Tx-Rate	Rx-Rate	Last-Event	IP-Address
Office	WLAN_AP2	0	2,4...	10	192.168.2...		HPnetel Model	54 %					0010x5223F	54 MB/s	54 MB/s	Key-Exchange ...	192.168.2.39
	WPA_WAP1EL	1	2,4...	11	192.168.2...												

3.7.3 Add access points

If an access point was not recognized automatically, it can be added to the list manually with the menu item **File / Add access point**. In the following window, enter the IP address or the name of the access point, the administrator name, and the corresponding password.

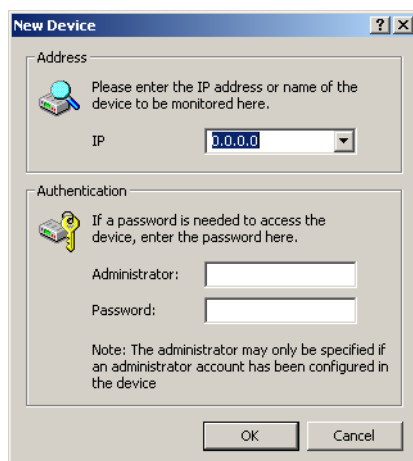

New Device

Address
Please enter the IP address or name of the device to be monitored here.
IP:

Authentication
If a password is needed to access the device, enter the password here.
Administrator:
Password:

Note: The administrator may only be specified if an administrator account has been configured in the device

OK Cancel

3.7.4 Organize access points

The LANCOM WLANmonitor lets you organize all of the available access points in a manner that is independent of their physical location. This helps to maintain an overview of the network and is particularly useful when localizing problems. Further, WLAN information can be called up according to the groups. You can group your access points according to their departments, locations or applications (e.g. public hotspot), for example.

The groups are shown in the left column in WLANmonitor. Starting from the top group 'WLANmonitor', you can use the menu item **File / Add group** to create new sub-groups and so build up a structure. Access points found during a search

are assigned to the currently selected group in the group tree. Access points that have been recognized already can be moved to the another group with drag and drop.

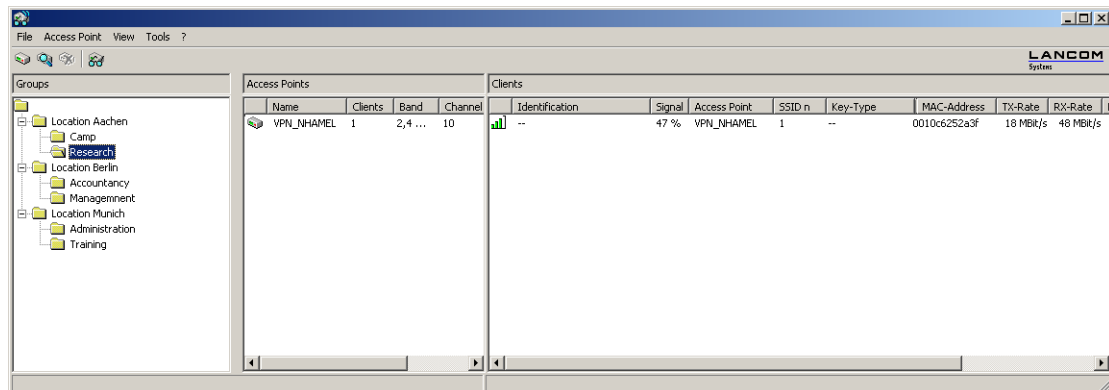

To aid the allocation of access points and clients, you can mark a device with the mouse. The counterpart(s) will then be marked in the list as well:

- If an access point is marked in the access point list, all of the clients logged in to this device will also be marked in the client list.
- If a client is marked in the client list, the access point that it is registered with will be marked in the access point list.

3.7.5 Rogue AP and rogue client detection with the WLANmonitor

WLAN devices that make unauthorized attempts at accessing a WLAN by posing as an access point or client are called rogues.

- Rogue clients are computers equipped with WLAN adapters that are located within the range of a WLAN and attempt to log on to one of the access points, for example, in order to use the Internet connection or in order to receive access to secured areas on the network.
- An example of rogue APs are access points that a company's employees connect to the network without the knowledge or permission of the system administrators, thereby consciously or unconsciously making the network vulnerable to potential attackers via unsecured WLAN access. Not quite as dangerous, but disruptive all the same are access points that belong to third-party networks yet are within the range of the local WLAN. If such devices also use the same SSID and channel as the local AP (default settings), then local clients could attempt to log on to external networks.

Unidentified access points within the range of the local network frequently pose a possible threat and security gap. At the very least they are a disturbance, and so they need to be identified to decide whether further measures in securing the local network need to be introduced. Information about the clients within range of your network is automatically stored to an internal table in the LANCOM Wireless Router. Once activated, background scanning records neighboring access points and records them to the scan table. WLANmonitor presents this information visually. The access points and clients found can be categorized in groups such as 'known', 'unknown' or 'rogue'.

! Further information can be found under .

Rogue AP detection

The WLANmonitor sorts all of the access points found into predefined subgroups under 'Rogue AP Detection' while displaying the following information:

- Time of first and last detection
- BSSID, the MAC address of the AP for this WLAN network
- Network name
- Type of encryption used
- Frequency band used
- Radio channel used

3 Configuration and management

- Use of 108Mbps mode

! To use rogue AP detection, background scanning has to be activated in the LANCOM Wireless Router.

The WLANmonitor uses the following groups for sorting the APs that are found:

- All APs: List of all scanned WLAN networks grouped as follows
- New APs: New unknown and unconfigured WLAN networks are automatically grouped here (APs displayed in yellow)
- Rogue APs: WLAN networks identified as rogue and in need of urgent observation (APs displayed in red)
- Unknown APs: WLAN networks which are to be further analyzed (APs displayed in gray)
- Known APs: WLAN networks which are not a threat (APs displayed in gray)
- Own APs: New affiliated WLAN networks from access points monitored by WLANmonitor are automatically grouped here (APs displayed in green)

The WLANs that have been found can be placed into a corresponding group depending on their status. You can set up your own network groups within the individual groups by using the context menu (right mouse button) (except for the group 'All APs').

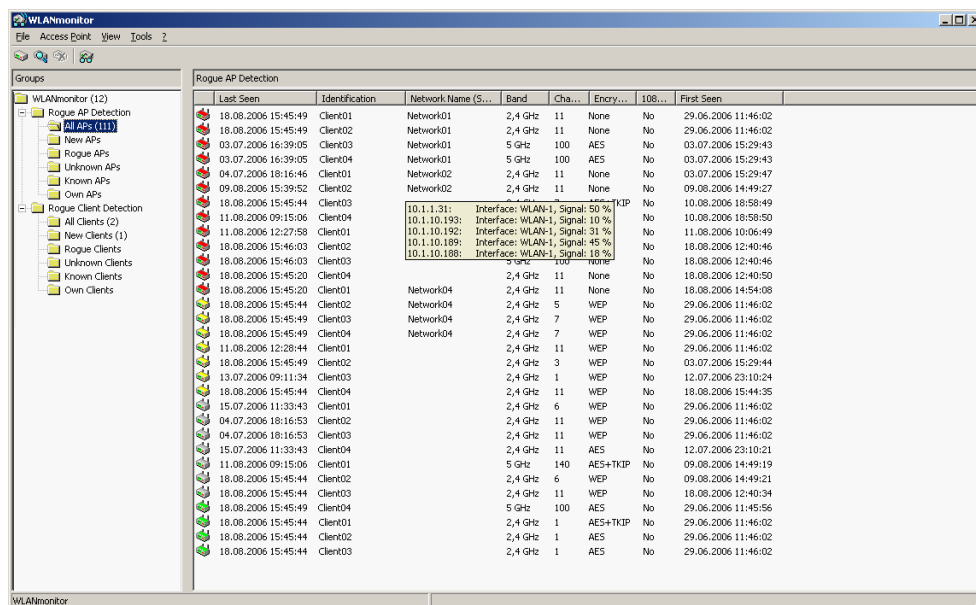

! If a parameter is changed on an AP, e.g. the security settings, then it is displayed again as a newly discovered AP.

Rogue client detection

The WLANmonitor presents all of the clients found into predefined subgroups under 'Rogue Client Detection' while displaying the following information:

- Time of first and last detection
- MAC address of the client
- Network name

! No configuration of the LANCOM Wireless Router is necessary to make use of rogue client detection.

The WLANmonitor uses the following groups for sorting the clients that are found:

- All clients: List of all found clients grouped as follows (clients are colored according to their group)
- New clients: New unknown clients are automatically grouped here (clients displayed in yellow)

- Rogue clients: Clients identified as rogue and in need of urgent observation (clients displayed in red)
- Unknown clients: Clients which are to be further analyzed (clients displayed in gray)
- Known clients: Clients which are not a threat (clients displayed in gray)
- Own clients: New affiliated clients associated with access points monitored by WLAN monitor are automatically grouped here (APs displayed in green)

The clients that have been found can be placed into a corresponding group depending on their status. You can set up your own network groups within the individual groups by using the context menu (right mouse button) (except for the group 'All clients').

Activating rogue-AP and rogue-client detection

The functions for rogue-AP and rogue-client detection can be switched on or off in WLANmonitor.

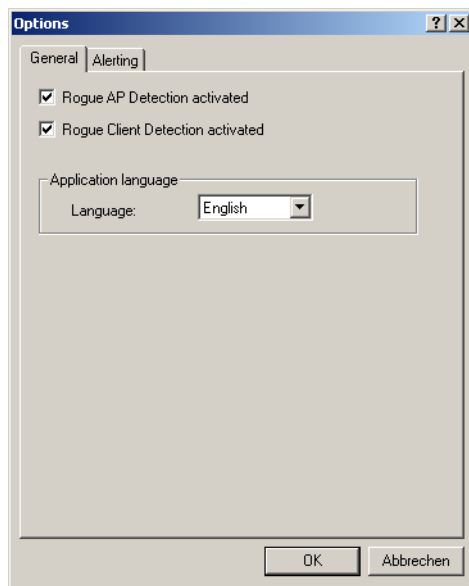

:WLANmonitor: Tools / Options / General

- Rogue AP detection activated
Activate this option if WLANmonitor is to display unknown or unconfigured access points.
- Rogue client detection activated
Activate this option if WLANmonitor is to display unknown or unconfigured clients.

Configuring the alert function in the WLANmonitor

The WLANmonitor can inform the administrator automatically via e-mail whenever an unknown or unconfigured access point is discovered.

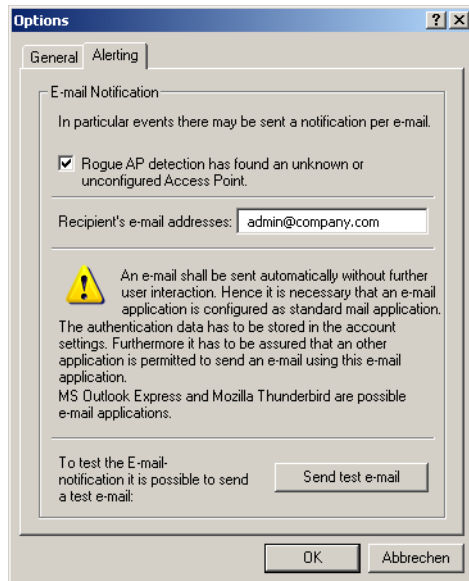

WLANmonitor: Tools / Options / Alerts

- E-mail messaging

Activate this option if you would like the WLANmonitor to report unknown or unconfigured access points via e-mail.

- Recipient e-mail addresses

Enter the e-mail address(es) of the administrators here that should be informed in the event of rogue AP detection. Multiple e-mail addresses should be separated by commas.

⚠ In order to send e-mail alerts, the computer on which WLANmonitor is running requires a standard e-mail client (MS Outlook Express or Mozilla Thunderbird) that allows automatic mail transmission to be configured and running.

- Send a test e-mail

Some mail clients require a confirmation from the user before sending via third-party applications. Test the alarm function with this button.

3.8 Configuration with WEBconfig

New with LCOS 7.6:

- New WEBconfig with search function, comprehensive device status, on-line help, etc.

Device settings can be configured from any Web browser. WEBconfig configuration software is an integral component of the LANCOM. A Web browser is all that is required to access WEBconfig. WEBconfig offers similar Setup Wizards to LANconfig and hence provides the perfect conditions for easy configuration of the LANCOM – although, unlike LANconfig, it runs under any operating system with a Web browser.

3.8.1 Secure with HTTPS

WEBconfig offers an encrypted transmission of the configuration data for secure (remote) management via HTTPS.

- `https://<IP address or device name>`

! For maximum security, please ensure to have installed the latest version of your Internet browser. For Windows 2000, LANCOM Systems recommends to use the "High Encryption Pack" or at least Internet Explorer 5.5 with Service Pack 2 or above.

3.8.2 Access with WEBconfig

To carry out a configuration with WEBconfig, you need to know how to contact the device. Device behavior and accessibility for configuration via a Web browser depend on whether the DHCP server and DNS server are active in the LAN already, and whether these two server processes share the assignment in the LAN of IP addresses to symbolic names.

Following power-on, unconfigured LANCOM devices first check whether a DHCP server is already active in the LAN. Depending on the situation, the device can either enable its own DHCP server or enable DHCP client mode. In the second operating mode, the device can retrieve an IP address for itself from a DHCP server in the LAN.

! If a LANCOM Wireless Router or LANCOM Access Point is centrally managed from a LANCOM WLAN Controller, the DHCP mode is switched from auto-mode to client mode upon provision of the WLAN configuration.

3.8.3 Network without a DHCP server

In a network without a DHCP server, unconfigured LANCOM devices enable their own DHCP server service when switched on and assign IP addresses, information on gateways, etc. to other computers in the LAN (provided they are set to automatic retrieval of IP addresses – auto DHCP). In this constellation, the device can be accessed by every computer with the auto DHCP function enabled with a Web browser under IP address **172.23.56.254**.

! With the factory settings and an activated DHCP server, the device forwards all incoming DNS requests to the internal Web server. This means that a connection can easily be made to set up an unconfigured LANCOM by entering any name into a Web browser.

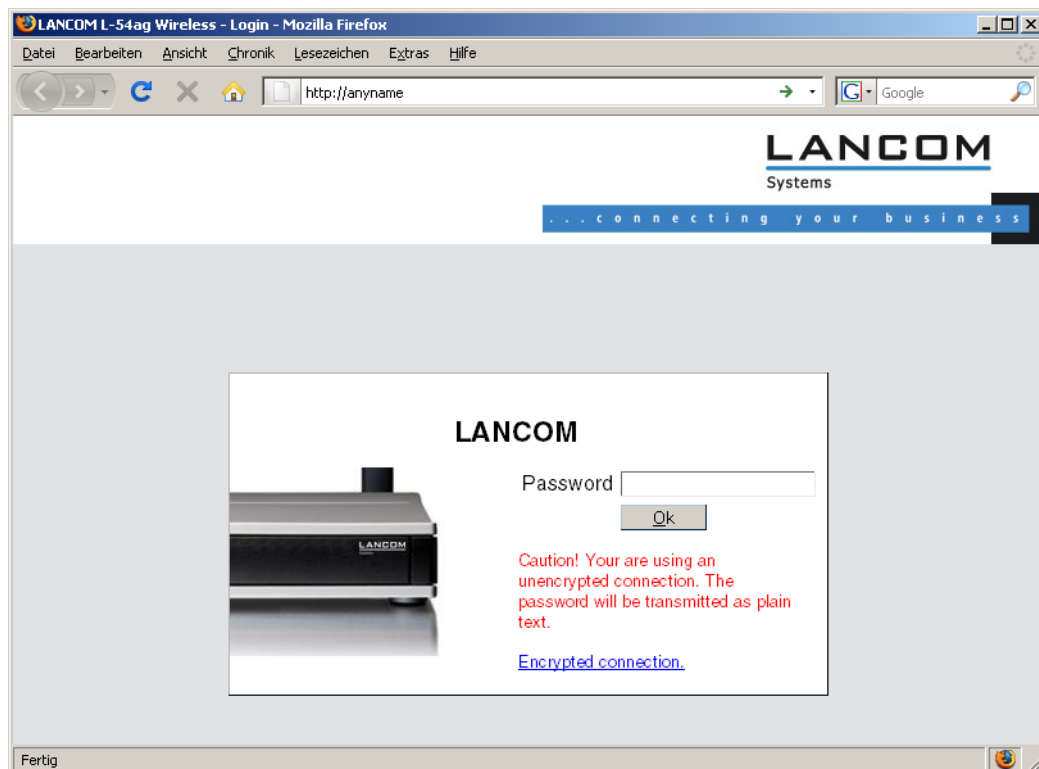

If the configuration computer does not retrieve its IP address from the LANCOM DHCP server, it determines the current IP address of the computer (with **Start / Run / cmd** and command **ipconfig** at the prompt under Windows 2000 or

Windows XP, with **Start / Run / cmd** and command **winipcfg** at the prompt under Windows Me or Windows 9x or with command **ifconfig** in the console under Linux). In this case, the LANCOM can be accessed with address **x.x.x.254** (the "x"s stand for the first three blocks in the IP address of the configuration computer).

3.8.4 Network with DHCP server

If a DHCP server for the assignment of IP addresses is active in the LAN, an unconfigured LANCOM device disables its own DHCP server, switches to DHCP client mode and retrieves an IP address from the DHCP server in the LAN. However, this IP address is initially unknown and accessing the device depends on the name resolution:

- If the LAN also has a DNS server for name resolution and this communicates the IP address/name assignment to the DHCP server, the device can be reached under name "-<MAC address>", e.g. "-00a057xxxxx".

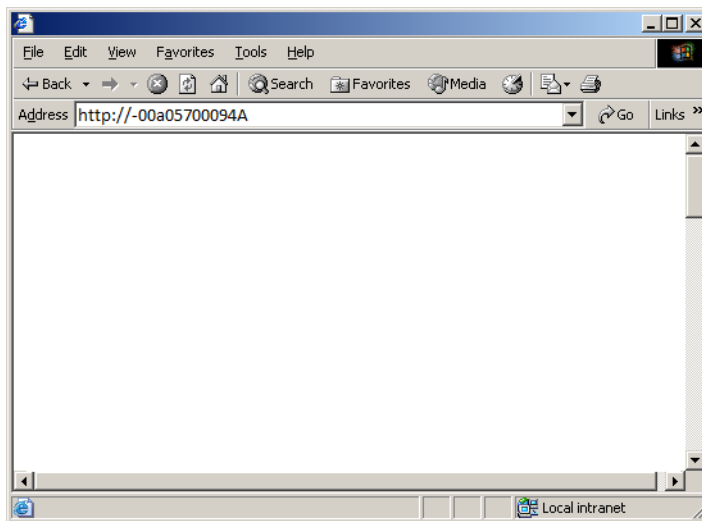

! The MAC address on a sticker on the base of the device.

- If there is no DNS server in the LAN, or if it is not coupled to the DHCP server, the device cannot be reached via the name. In this case the following options remain:
 - Use LANconfig's "Find Device" function, or perform WEBconfig's "Device Search" from another yet accessible LANCOM.
 - Use suitable tools to find out the IP address assigned to the LANCOM by DHCP and access the device directly using this IP address.
 - Use the serial configuration interface to connect a computer running a terminal program to the device.

3.8.5 Login

When prompted for user name and password when accessing the device, enter your personal data in the appropriate fields. Observe the use of upper and lower case.

If you used the general configuration access, only enter the corresponding password. The user name field remains blank in this case.

- ! As an alternative, the login dialog provides a link for an encrypted connection over HTTPS. Always use the HTTPS connection for increased security whenever possible.

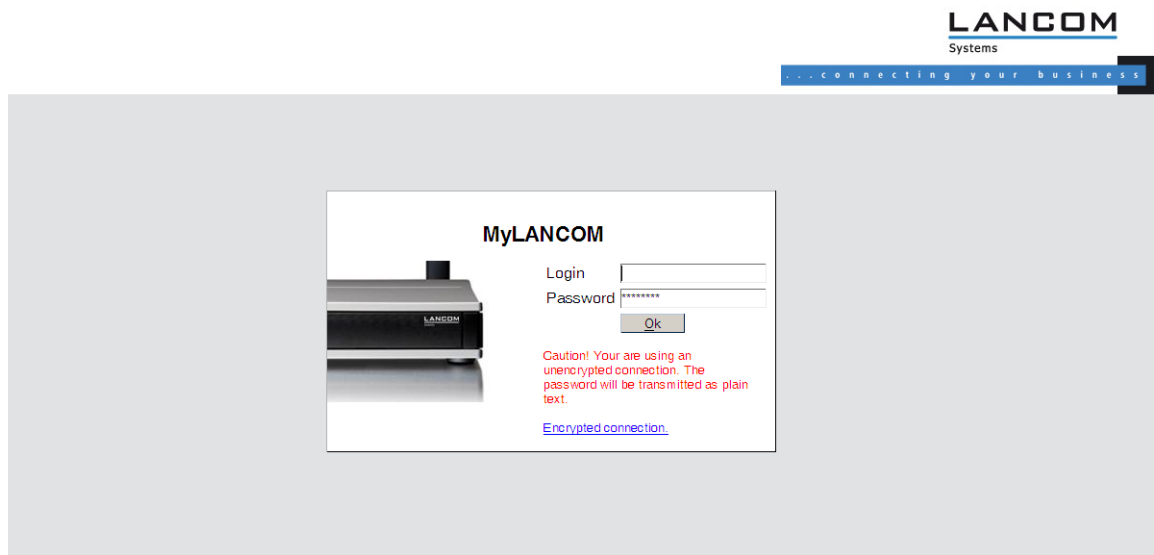

3.8.6 Setup Wizards

The setup Wizards allow quick and easy configuration of the most common device settings. Select the Wizard and enter the appropriate data on the following screens.

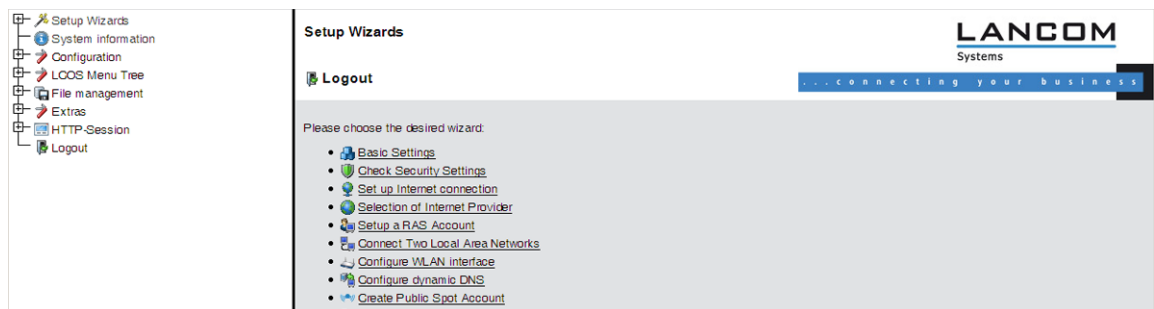

- ! The settings are not stored in the device until inputs are confirmed on the last screen of the Wizard.

3.8.7 System information

Under the "System Data" tab on the system information screen displays general information on the device including its location, the firmware version, the serial number, etc.

System information

Logout

System data | Device status | Syslog

Name:

Location:

Administrator:

Comments:

Device type:

Hardware release:

Firmware version:

Serial number:

LANCOM
Systems
... connecting your business

The "Device status" tab contains comprehensive information on the current operating state of the device. This includes, for example, a visual representation of the interfaces with information on the networks active on them. Appropriate links

can be used to call up further relevant statistics (such as DHCP table). For significant configuration deficiencies (such as invalid time setting), a direct link to the appropriate configuration parameters is provided.

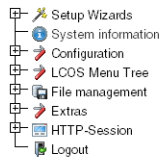

System information

Logout

System data Device status Syslog

connecting your business

Interface/Port	State/Mode	Information										
CPU-Load	Current: 5.56%											
Memory	Total: 12.5 MBytes Free: 3.3 MBytes											
WLAN-1	Operating: Yes Operation-Mode: Access-Point	Num-Stations: 1 Noise-Level: -85 dBm Modem-Load: 1 Transmit-Power: 15 dBm Throughput: 4.5 KB										
Point-to-Point connections	No connections are configured.											
WAN												
LAN-1												
LAN-2												
LAN-3												
LAN-4		Assignment: LAN-1 Private-Mode: No Link-Active: Yes Connector: 100 Mbit Full-Duplex Auto-Negotiation: Completed Flow-Control: Yes MDI-Mode: MDIX										
DHCP	Network-name: INTRANET Server-Flags: Client	DHCP-Table										
DNS	Operating: Yes	Hit-List										
VPN	Tunnel: 0	Connection: No connection available										
ISDN	S0-1: Deactivated (F3)	State: none Setup: none App: none Mode: unk. Number: S0-1-B2: State: none Setup: none App: none Mode: unk. Number:										
DSL-LoL	<table style="width: 100%; border-collapse: collapse;"> <thead> <tr> <th style="width: 50%;">Ifc</th> <th style="width: 50%;">Link-Active</th> </tr> </thead> <tbody> <tr><td>DSL-1</td><td>No</td></tr> <tr><td>DSL-2</td><td>No</td></tr> <tr><td>DSL-3</td><td>No</td></tr> <tr><td>DSL-4</td><td>No</td></tr> </tbody> </table>	Ifc	Link-Active	DSL-1	No	DSL-2	No	DSL-3	No	DSL-4	No	
Ifc	Link-Active											
DSL-1	No											
DSL-2	No											
DSL-3	No											
DSL-4	No											
Time	Invalid time	Set Date and Time										
IP-Addresses	Configured Networks INTRANET: 192.168.2.35 DMZ: 0.0.0.0											

3 Configuration and management

The amount of information shown on this screen can be defined under Setup/HTTP/Show device information. An index number is also used to specify the display sequence.

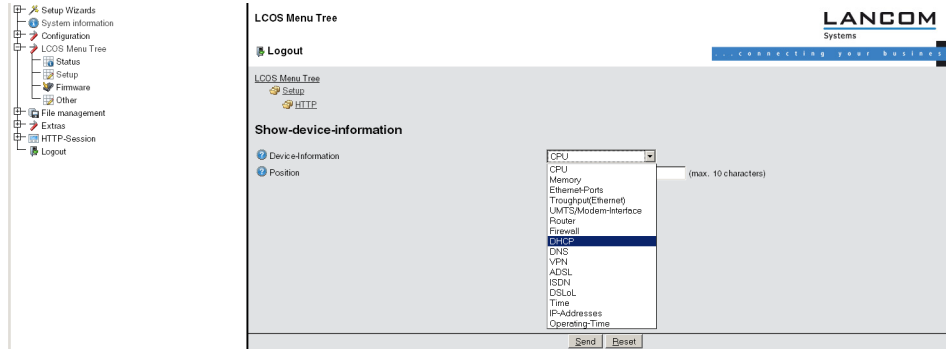

LANCOM devices also store syslog information to the main memory (see Syslog). You can also view the latest syslog entries in WEBconfig under "System information".

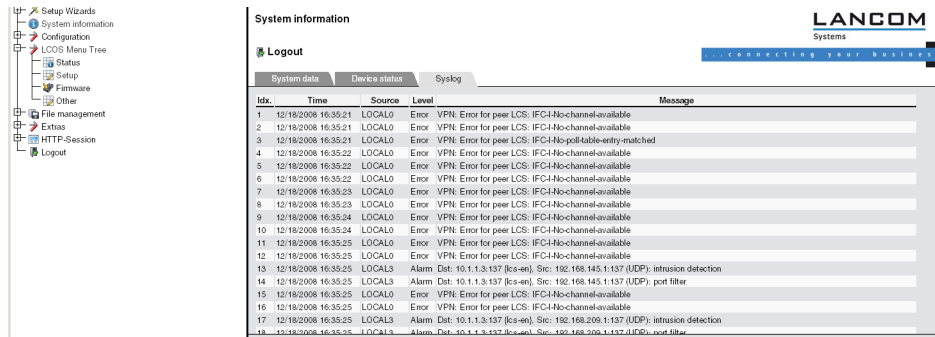

3.8.8 Configuration

Menu area "Configuration" provides the configuration parameters in the same structure as they are used in LANconfig.

 Please note that not all settings can be configured from this configuration view.

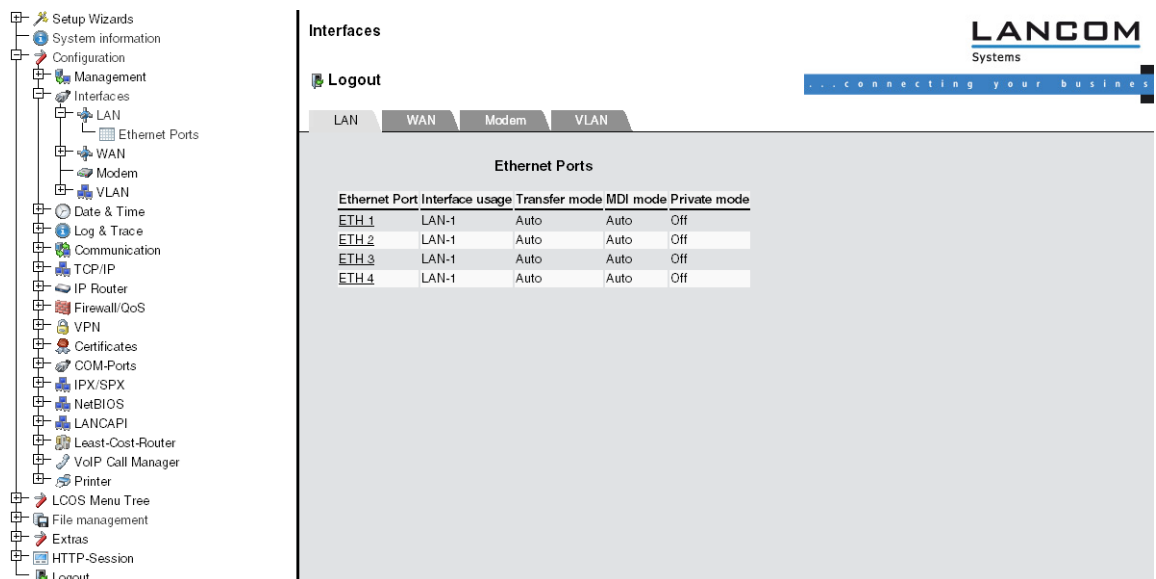

3.8.9 LCOS menu tree

Menu area "LCOS menu tree" provides the configuration parameters in the same structure as they are used under Telnet. Clicking the question mark calls up help for each configuration parameter.

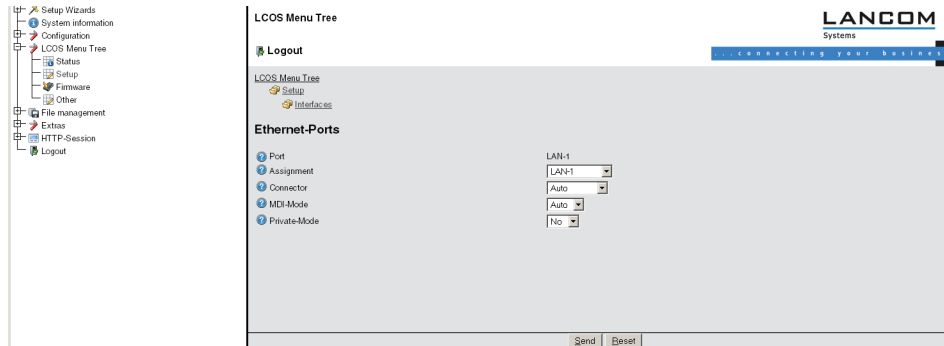

3.8.10 File management

The menu area "File management" contains all actions with which files are downloaded from the device and uploaded to the device:

- Uploading new firmware
- Saving configuration
- Uploading configuration
- Using configuration script
- Saving configuration script
- Uploading certificate or file
- Downloading certificate or file

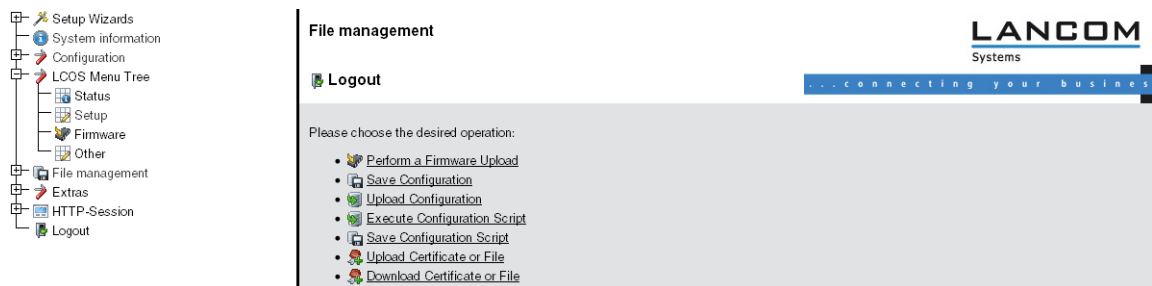

3.8.11 Extras

The menu area "Extras" contains a few functions that simplify device configuration.

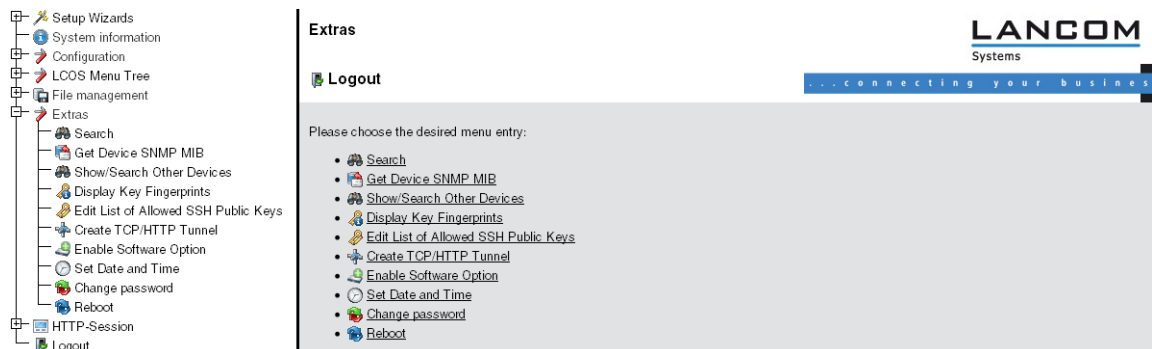

3 Configuration and management

The search function can be used, for example, to search the names for all configuration parameters. If you know the name for a particular configuration parameter, but do not know which menu is used to reach this entry, you can quickly locate the required place in the LCOS menu in this way.

The screenshot shows the LANCOM web interface with a search results page. On the left is a navigation tree with 'Extras' expanded to 'Search'. The main content area is titled 'Search Results' and shows three matches for the search term 'radius':

- [LCOS Menu Tree: Status/TCP-IP/RADIUS-Client](#) (90% match, path: /config/1/9/13)
- [LCOS Menu Tree: Setup/WAN/RADIUS](#) (90% match, path: /config/2/2/22)
- [LCOS Menu Tree: Setup/RADIUS](#) (90% match, path: /config/2/25)

Using the Show/Search function, you can search for other LANCOM devices in your network and switch directly to the configuration of the devices located via a corresponding link.

The screenshot shows the 'Show/Search Other Devices' page in the LANCOM web interface. The navigation tree on the left has 'Extras' expanded to 'Show/Search Other Devices'. The main content area displays a table of discovered devices:

Name	Device Type	Address	Status
MyLANCOM	LANCOM 1811 Wireless DSL	192.168.2.35	Ready
VP-100-00A0571278LANCOM_VP-100	LANCOM VP-100	192.168.2.47	Ready

Below the table are buttons for 'Rescan a Remote Network' and 'Rescan Local Network', and input fields for 'Network Address' (192.168.2.0) and 'Network Mask' (255.255.255.0).

3.8.12 HTTP session

Menu area "HTTP session" allows you to customize the display of the WEBconfig interface to your output device for improved readability, e. g. by lowering the resolution or increasing the contrast.

The screenshot shows the 'HTTP-Session' configuration page in the LANCOM web interface. The navigation tree on the left has 'HTTP-Session' selected. The main content area is titled 'HTTP-Session' and contains the following options:

Please choose the used style for this session:

- Switch to normal design
- Switch to design for small resolutions
- Switch to design with high contrast

3.9 Configuration with other tools

3.9.1 Telnet

New with LCOS 7.6:

- Extended functions for editing commands
- Function keys

Open Telnet session

To commence the configuration, start Telnet from the Windows command line with command:

- `C:\>telnet 10.0.0.1`

Telnet establishes a connection to the device with the IP address entered.

After entering the password (assuming one has been set to protect the configuration) all of the configuration commands are available to you.

! Linux and Unix additionally support Telnet sessions via SSL-encrypted connections. Depending on the distribution it may be necessary to replace the standard Telnet application with an SSL-capable version. Start the encrypted Telnet connection with the following command:

- `C:\>telnet -z ssl 10.0.0.1 telnets`

Changing the console language

The terminal mode operates with the languages English and German. LANCOM devices are set with English as the standard console language. If necessary, change the console language with the following commands:

WEBconfig: LCOS menu tree / Config-Module / Language

Close the Telnet session

To close the Telnet session, enter the command `exit` at the command prompt:

- `C:\>exit`

Structure of the command-line interface

The LANCOM command-line interface is always structured as follows:

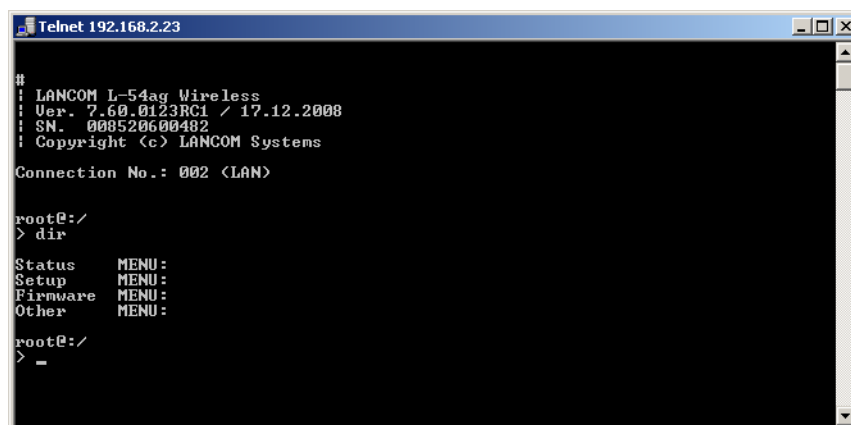

```

Telnet 192.168.2.23
#
! LANCOM L-54ag Wireless
! Ver. 7.60_0123RC1 / 17.12.2008
! SN. 008520600482
! Copyright (c) LANCOM Systems
Connection No.: 002 <LAN>

root@:/
> dir
Status   MENU:
Setup    MENU:
Firmware MENU:
Other    MENU:

root@:/
> _

```

- **Status** Contains the status and statistics of all internal modules in the device
- **Setup** Contains all adjustable parameters of all internal modules in the device
- **Firmware** Contains the firmware management
- **Others** Contains actions for establishing and terminating connections, reset, reboot and upload.

Command-line commands

The LANCOM command-line interface can be operated with the following DOS- or UNIX-style commands. The LCOS menu commands that are available to you can be displayed at any time by entering HELP at the command line.

 Supervisor rights are necessary to execute some commands.

Command	Description
beginscript	Resets the console session to script mode. In this state, commands entered are not transferred directly to the LANCOM's configuration RAM but initially to the device's script memory.
cd [PATH]	Switch to the current directory. Various abbreviations can be used, such as replacing " cd ../." with "cd ...", etc.
del [PATH]*	Deletes the table in the branch of the menu tree defined with <code>Path</code> .
default [-r] [PATH]	Resets individual parameters, tables or entire menu trees back to their default configuration. If <code>PATH</code> indicates a branch of the menu tree, then the option <code>-r</code> (recursive) must be entered.
dir [PATH] list [PATH] ls [PATH] ll [PATH]	Displays the current directory content. The suffix parameter "-a" lists the SNMP IDs associated with the content of the query. The output begins with the SNMP ID of the device followed by the SNMP ID of the current menu. The SNMP IDs of the subordinate items can be read from the individual entries.
do [PATH] [<Parameter>]	Executes the action [PATH] in the current directory. Other parameters can be entered in addition.
echo <ARG>...	Display argument on console
exit/quit/x	Ends the command line session
feature <code>	Activation of a software feature with the feature code as entered
flash Yes/No	Changes to the configuration using commands in the command line are written directly to the boot-resistant Flash memory of the devices as standard (flash yes). If updating the configuration is suppressed in Flash (flash no), changes are only stored in RAM (deleted on booting).
history	Displays a list of recently executed commands. Command "I#" can be used to directly call the list commands using their number (#): For example, "I3" runs the third list command.
killscript	Deletes the script session contents yet to be processed. The script session is selected by its name.
loadconfig	Load configuration into device via TFTP client
loadfirmware	Load firmware into device via TFTP client
loadscript	Load script into device via TFTP client
passwd	Change password
passwd -n new [old]	Change password (no prompt)
ping [IP address or name]	Sends an ICMP echo request to the IP address specified

Command	Description
readconfig	Display of the entire configuration in the device syntax
readmib	Display of the SNMP Management Information Base
readscript [-n] [-d] [-c] [-m] [PATH]	In a console session, the readscript command generates a text dump of all commands and parameters required to configure the LANCOM in its current state.
repeat <INTERVAL> <Command>	Repeats the command every INTERVAL seconds until the process is ended with new input
sleep [-u] value[suffix]	Delays the processing of configuration commands by a particular time or terminates them at a particular time. Permissible suffixes are s, m and h for seconds, minutes and hours. If no suffix is defined, the command uses milliseconds. With option switch -u, the sleep command accepts times in format MM/DD/YYYY hh:mm:ss (English) or in format TT.MM.JJJJ hh:mm:ss (German). Date configuration is only accepted if the system time is set.
stop	Ends the PING command
set [PATH] <value(s)>	Sets a configuration parameter to a particular value. If the configuration parameter is a table value, a value must be specified for each column. Entering the "*" character leaves any existing table entry unchanged.
set [PATH] ?	Listing of the possible input values for a configuration parameter. If no name is specified, the possible input values for all configuration parameters in the current directory are specified.
setenv <NAME> <VALUE>	Set environment variable
unsetenv <NAME>	Delete environment variable
getenv <NAME>	Display environment variable (no line feed)
printenv	Display the entire environment
show <options>	Display of special internal data. show ? displays all available information, such as most recent boot processes ('bootlog'), firewall filter rules ('filter'), VPN rules ('VPN') and memory usage ('mem' and 'heap')
sysinfo	Display of system information (e.g. hardware/software version)
testmail	Sends an e-mail. See 'testmail ?' for parameters
time	Set time (DD.MM.YYYY hh:mm:ss)
trace [...]	Configuration of the diagnostics display.
who	List active sessions
writeconfig	Load a new configuration file in the device syntax. All subsequent lines are interpreted as configuration values until two blank lines occur
writeflash	Load a new firmware file (only via TFTP)
!!	Repeat last command
!<num>	Repeat command <num> times
!<prefix>	Repeat last command beginning with <prefix>

Command	Description
#<blank>	Comment

- **PATH:**
 - Path name for a menu or parameter, separated by / or \
 - .. means one level higher
 - . means the current level
- **VALUE:**
 - Possible input value
 - "" is a blank input value
- **NAME:**
 - Sequence of characters (made up of _ 0..9 A..Z)
 - First character cannot be a digit
 - Case insensitive
- All commands and directory/parameter names can be entered using their short-forms as long as they are unambiguous. For example, command "sysinfo" can be shortened to "sys" and "cd Management" to "c ma". Input "cd /s" is not valid, however, since it corresponds to both "cd /Setup" and "cd /Status".
- Names that contain spaces must be enclosed within quotation marks ("").
- A command-specific help function is available for actions and commands (call the function with a question mark as the parameter). For example, 'ping ?' shows the options of the integrated ping command.
- Enter '?' on the command line for a complete listing of the console commands available.

Addition(s) to LCOS 8.60

View contents of all subdirectories

The parameter `-r` causes the shell commands `dir`, `ls`, `list` and `ll` to display all subdirectories and the tables in them.

```
admin@:/
> dir -r status/ppp

PPP-Phases      TABINFO: 2 x [Ifc,Phase,LCP,IPCP,CCP,IPV6CP]
LCP             MENU:
PAP             MENU:
CHAP            MENU:
IPCP            MENU:
CCP             MENU:
Rx-Options      MENU:
Tx-Options      MENU:
Delete-Values   ACTION:
IPV6CP          MENU:

[rek] PPP-Phases:
Ifc             Phase to  LCP             IPCP             CCP             IPV6CP
-----
DSL-CH-1       DEAD      Initial          Initial          Initial
Initial
EXT            DEAD      Initial          Initial          Initial
Initial
```

```

[rek] LCP:
Rx-Errors          INFO:    0
Rx-Discarded       INFO:    0
Rx-Config-Request  INFO:    0
Rx-Config-Ack.     INFO:    0
Rx-Config-Nak.     INFO:    0
Rx-Config-Reject   INFO:    0
Rx-Terminate-Request INFO:    0
Rx-Terminate-Ack.  INFO:    0
Rx-Code-Reject     INFO:    0
Rx-Protocol-Reject INFO:    0
Rx-Echo-Request    INFO:    0
Rx-Echo-Reply      INFO:    0
Rx-Discard-Request INFO:    0
Tx-Config-Request  INFO:    0
Tx-Config-Ack.     INFO:    0
Tx-Config-Nak.     INFO:    0
Tx-Config-Reject   INFO:    0
Tx-Terminate-Request INFO:    0
Tx-Terminate-Ack.  INFO:    0
Tx-Code-Reject     INFO:    0
Tx-Protocol-Reject INFO:    0
Tx-Echo-Request    INFO:    0
Tx-Echo-Reply      INFO:    0
Tx-Discard-Request INFO:    0
Delete-Values      ACTION:

[rek] PAP:
Rx-Discarded       INFO:    0
Rx-Request          INFO:    0
Rx-Success          INFO:    0
Rx-Failure          INFO:    0
Tx-Retry            INFO:    0
Tx-Request          INFO:    0
Tx-Success          INFO:    0
Tx-Failure          INFO:    0
Delete-Values      ACTION:

[rek] CHAP:
Rx-Discarded       INFO:    0
Rx-Challenge        INFO:    0
Rx-Response         INFO:    0
Rx-Success          INFO:    0
Rx-Failure          INFO:    0
Tx-Retry            INFO:    0
Tx-Challenge        INFO:    0
Tx-Response         INFO:    0
Tx-Success          INFO:    0
Tx-Failure          INFO:    0
Delete-Values      ACTION:

[rek] IPCP:
Rx-Discarded       INFO:    0
Rx-Config-Request  INFO:    0
Rx-Config-Ack.     INFO:    0
Rx-Config-Nak.     INFO:    0
Rx-Config-Reject   INFO:    0

```

```

Rx-Terminate-Request  INFO:    0
Rx-Terminate-Ack.    INFO:    0
Rx-Code-Reject       INFO:    0
Tx-Config-Request    INFO:    0
Tx-Config-Ack.       INFO:    0
Tx-Config-Nak.       INFO:    0
Tx-Config-Reject     INFO:    0
Tx-Terminate-Request INFO:    0
Tx-Terminate-Ack.    INFO:    0
Tx-Code-Reject       INFO:    0

MORE [Q(uit)]>

```

Output filter for command-line entries

The command-line commands `show`, `dir` and `ls` generates large amounts of output. The filters allow you to sift out the information that is important for you from all the information.

To enable the filters, extend the commands to include the parameter "@", which initiates the following filter definition. The following operators apply to filter definitions:

Operator	Description
(space)	OR operator: The filter applies when one of the parameters occurs in the output
+	AND operator: The filter applies when the operand occurs in the output
-	NOT operator: The filter applies when the operand does not occur in the output
"	The output must exactly match the search filter

Any string combination can be used to specify the operands, such as the names of remote stations, protocols or ports. The filter then processes these data according to the rule of the operators used, in a similar way to Internet search engines.

❗ The filter enhances the preceding command one time only. If you invoke the command again without specifying a filter, the output appears unfiltered again.

❗ No filter is available for the following features:

- `show bootlog`
- `show ethswitch rmon`
- `show mem`
- `show random`
- `show ssh idkeys`
- `show tls fingerprints`
- `show tls heap`

The command `show vpn` displays all current VPN connections. The filter `show vpn @ "sales_ger"` reduces the display to the connections with a name containing the string "sales_ger" (i.e. sales representatives in Germany).

The command `ls /Setup/IP-Router/IP-Routing-Table` shows the parameters to be used for accessing configured networks or remote sites. The filter `ls /Setup/IP-Router/IP-Routing-Table @ -"192.168."` suppresses the display of stations in this private IP address range.

Line-by-line display of table entries

When working with the command line, displaying tables with several columns is often confusing because the standard line length is 80 characters. Useful for large tables, you can go directly to the any row by entering a row index when invoking the `cd` command. In this way, the commands `dir` and `ls` display the content of the line in a three-column table:

- **Left column:** Property
- **Middle column:** Type
- **Right column:** Value

! If the specified row does not exist an error message is displayed. If another working directory has been specified, then a column parameter is ignored.

In this three-column view, you can use the shell command `set <property> <value>` directly to write a new value into the corresponding field.

! The `set` command also processes complete paths. Enter the table entries that begin with the characters "..", "/" and "\" between quotes.

1. The command `cd Status/LAN/Interfaces` takes you to the overview of the LAN interfaces.
2. The `ls` command lists all the information about the interfaces in a table:

```

Ifc      Queue-Packets      Link-Active
-----
LAN-1    0                  Yes
LAN-2    0                  No
LAN-3    0                  No
LAN-4    0                  No

```

3. With the command `cd lan-4` you move to the corresponding table row.
4. The `ls` command lists the content of this row only:

```

Ifc      INFO:      LAN-4
Queue-Packets      INFO:      0
Link-Active      INFO:      No

```

Functions for editing commands

The following commands can be used to edit commands on the command line. The "ESC key sequences" show (for comparison) the shortcuts used on typical VT100/ANSI terminals

:

Function	Esc key sequences	Description
Up arrow	ESC [A	In the list of commands last run, jumps one position up (in the direction of older commands).
Down arrow	ESC [B	In the list of commands last run, jumps one position down (in the direction of newer commands).
Right arrow	Ctrl-F ESC [C	Moves the insert cursor one position to the right.
Left arrow	Ctrl-B ESC [D	Moves the insert cursor one position to the left.

Function	Esc key sequences	Description
Home or Pos1	Ctrl-A ESC [A ESC [1~ (Moves the insert cursor to the first character in the line.
End	Ctrl-E ESC [F ESC OF ESC [4~	Moves the insert cursor to the last character in the line.
Ins	ESC [ESC [2~	Switches between input and overwrite modes.
Del	Ctrl-D ESC <BS>ESC [3~	Deletes the character at the current position of the insert cursor or ends the Telnet session if the line is blank.
erase	<BS>	Deletes the next character to the left of the insert cursor.
erase-bol	Ctrl-U	Deletes all characters to the left of the insert cursor.
erase-eol	Ctrl-K	Deletes all characters to the right of the insert cursor.
Tabulator		<p>Completes the input from the current position of the insert cursor for a command or path of the LCOS menu structure:</p> <ol style="list-style-type: none"> 1. If there is only one possibility of completing the command/path, this is accepted by the line. 2. If there is more than one possibility of completing the command/path, this is indicated by an audible sound when pressing the Tab key. Pressing the Tab key again displays a list of all possibilities to complete the entry. Then enter another character, for example, to allow unambiguous completion of the input. 3. If there is no possibility of completing the command/path, this is indicated by an audible sound when pressing the Tab key. No further actions are run.

Function keys for the command line

- Telnet: Setup / Config / Function keys

The function keys enable the user to save frequently used command sequences and to call them easily from the command line. In the appropriate table, commands are assigned to function keys F1 to F12 as they are entered in the command line.

- Key

Name of function key.

Possible values:

- Selection from function keys F1 to F12.

Default:

- F1

- Mapping

Description of the command/shortcut to be run on calling the function key in the command line.

Possible values:

- All commands/shortcuts possible in the command line

Default:

- Blank

Special values:

- The caret symbol ^ is used to represent special control commands with ASCII values below 32. ^a
- ^A stands for Ctrl-A (ASCII 1)
- ^Z stands for Ctrl-Z (ASCII 26)

- `^[]` stands for Escape (ASCII 27)
- `^^` A double caret symbol stands for the caret symbol itself.

! If a caret symbol is entered in a dialog field or editor followed directly by another character, the operating system may possibly interpret this sequence as another special character. A Windows operating system makes, for example, an Å from input caret symbol + A. To call the caret symbol itself, enter a space before the following character. Sequence `^A` is then formed from caret symbol + space + A.

3.9.2 SNMP

The Simple Network Management Protocol (SNMP V.1 as specified in RFC 1157) allows monitoring and configuration of the devices on a network from a single central instance.

There are a number of configuration and management programs that run via SNMP. Commercial examples are Tivoli, OpenView from Hewlett-Packard, SunNet Manager and CiscoWorks. In addition, numerous programs also exist as freeware and shareware.

Your LANCOM can export a so-called device MIB file (**M**anagement **I**nformation **B**ase) for use in SNMP programs.

WEBconfig: Extras / Get Device SNMP MIB

3.9.3 Encrypted configuration with SSH access

In addition to the option to configure a LANCOM with Telnet or a terminal program, LCOS version 4.00 and later provides an additional option of access via SSH. With a suitable SSH client such as PuTTY, you can set up an encrypted connection to the device and thus prevent the data being transferred during configuration from being intercepted within the network.

Start PuTTY (for example) and enter the LANCOM device's IP address as the host name. Use the command prompt that follows to log in by entering your user data.

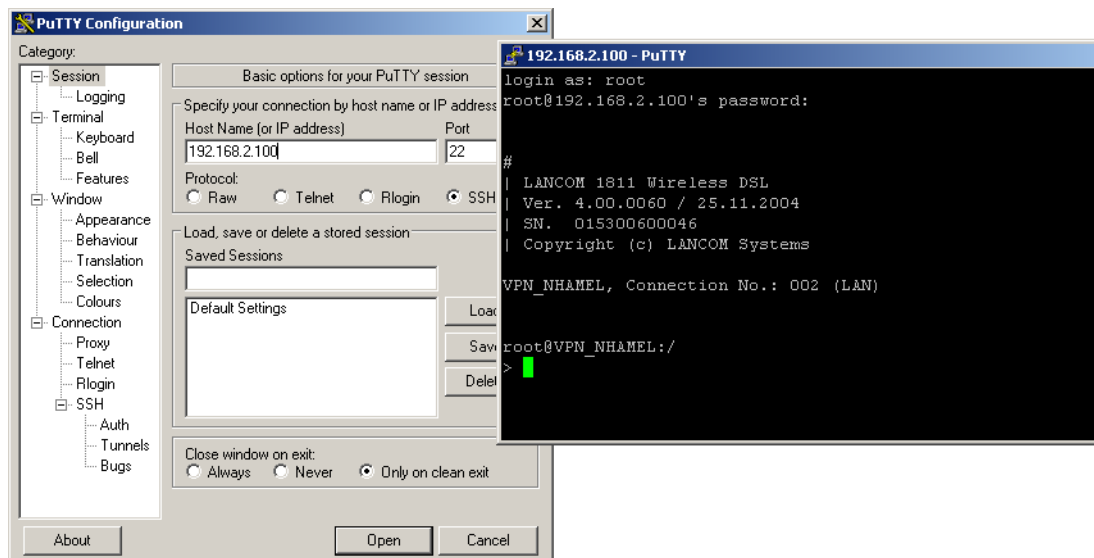

Alternatively, you can use LANconfig under **Tools / Options / Extras** to enter your SSH client as an "external program"; then start the SSH access with a right-mouseclick on the device and open **WEBconfig/Console session / Open SSH session**.

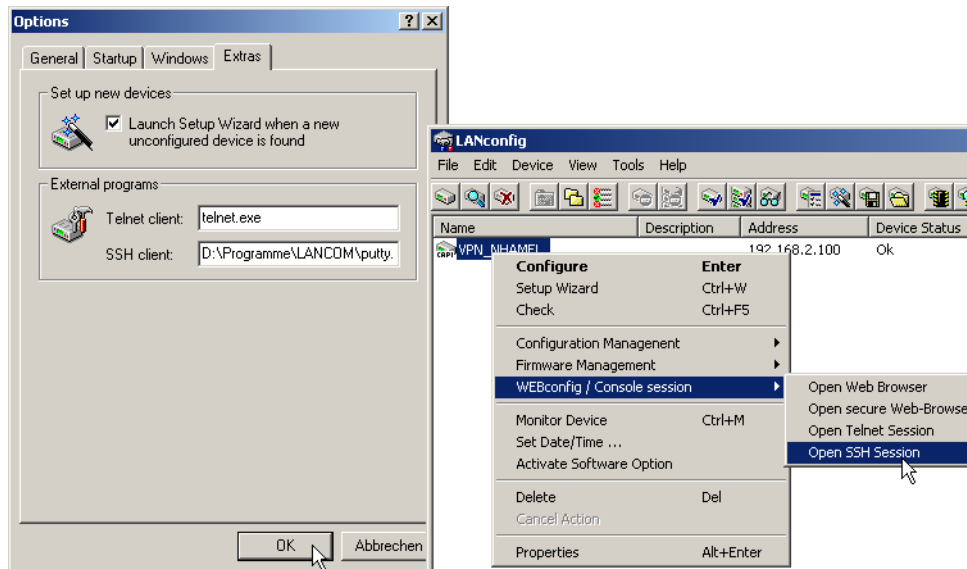

The configuration is carried out with the same commands as used under Telnet or other terminal program.

3.9.4 SSH authentication

The SSH protocol generally allows two different authentication mechanisms:

- With user name and password
- With the help of a public key

In the public key method, a key pair is used that is made up of a private and public key – a digital certificate. Detailed information about the keys mentioned here can be found under the section 'Digital certificates' in the chapter on VPN in the reference manual. The private part of the key pair is saved on the client (frequently protected with a password), the public part is loaded into the LANCOM Router.

The LANCOM Router supports both RSA and DSS/DSA keys. RSA keys are somewhat smaller, thereby allowing somewhat faster operation.

Generating key pairs

The pairs consisting of public and private keys can be generated with the help of OpenSource software OpenSSH, for example. The following command from a Linux operating system creates a key pair from the public part 'id_rsa.pub' and the private part 'id_rsa':

```
ssh-keygen -t rsa
```

Entering users into the public key

The public keys are generated in the following syntax:

```
<Encryption algorithm> <Public key> <User> [Further users]
```

In order to grant access to additional users with this key, the respective user names are simply attached to the existing key file.

Installing the private key on the SSH client

The private part of the key must be installed on the SSH client. Refer to the documentation for information on the steps required for your SSH client.

Load public key into the LANCOM Router

The public key(s) can be uploaded to the LANCOM Router using WEBconfig. For this, select the entry **Upload certificate or file** on the WEBconfig start page. In the following dialog, select the type of key ('SSH RSA key' or 'SSH DSA key'), select the file and enter the password if required. Entering the Upload command initiates the transfer to LANCOM.

 The uploaded file replaces an existing list of accepted keys in the device. Another way is to choose the entry **edit list of allowed public keys** at the start page of WEBconfig and edit the key directly. You can as well edit single keys to the existing list.

Configuring the authentication methods

The authentication methods permitted for SSH access can be set separately for LAN, WAN and WLAN.

Configuration tool	Call
WEBconfig, Telnet	LCOS menu tree > Setup > Config > SSH authentication methods

- Methods
 - All: Allows authentication using password and digital certificate.
 - Password: Allows authentication with a password.
 - Public key: Only allows authentication with a digital certificate.

Certificate check on SSH access

When establishing the SSH connection, the client first asks the LANCOM Router which authentication methods are permitted for this connection. If the public key method is allowed, the client searches for private keys that have been installed and transfers these with the user name to the LANCOM Router. When the LANCOM Router finds an entry in the list that includes the user name that corresponds to its public SSH key, the SSH connection is permitted. If the client does not have a suitable private key installed or if the LANCOM Router does not have a corresponding entry with the user name or public key, the SSH client can revert to authentication with user name/password – as long as this authentication method is permitted.

3.9.5 ISDN Remote configuration via Dial-Up Network

 The complete section on remote configuration applies only to LANCOM with ISDN interface or a serial interface (with LANCOM Modem Adapter Kit).

Configuring routers at remote sites is particularly easy using the remote configuration method via a Dial-Up Network from Windows. The device is accessible by the administrator immediately without any settings being made after it is switched on and connected to the ISDN interface. This means that you save a lot of time and costs when configuring at separate locations because you do not have to travel to the other network or instruct the staff on-site on configuring the router.

You can also reserve a special calling number for remote configuration. Then the support technician can always access the router even if it is really no longer accessible due to incorrect settings.

This is what you need for ISDN remote configuration

- An LANCOM with an ISDN connection
- A computer with a PPP client, e.g. Windows Dial-Up Network
- A program for inband configuration, e.g. LANconfig or Telnet

- A configuration PC with an ISDN card or access via LANCAPI to a LANCOM with ISDN access.

The first remote connection using Dial-Up Networking

For the remote connection of a LANCOM with LANconfig using Dial-Up Networking proceed as follows:

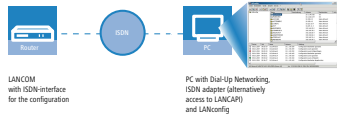

1. In the LANconfig program select **Device / New**, enable 'Dial-Up connection' as the connection type and enter the calling number of the ISDN interface to which the LANCOM is connected. If you wish, you can also enter the time period after which an idle connection is to be disconnected automatically.
2. LANconfig now automatically generates a new entry in the Dial-Up Network. Select a device that supports PPP (e.g. the NDIS-WAN driver included with the LANCAPI) for the connection and press **OK** to confirm.
3. Then the LANconfig program will display a new device with the name 'Unknown' and the dial-up call number as the address in the device list.



When an entry in the device list is deleted, the related connection in the Windows Dial-Up Network is also deleted.

4. You can configure the device remotely just like all other devices. LANconfig establishes a dial-up connection enabling you to select a configuration.



Always provide additional protection for the settings of the device by setting a password by switching to the 'Security' tab in the 'Management' configuration section.

The first remote connection using a PPP client and Telnet

Instead of a remote configuration with LANconfig it is also possible to access over ISDN with Telnet. For a remote configuration of a LANCOM with Telnet over any PPP client proceed as follows:

|

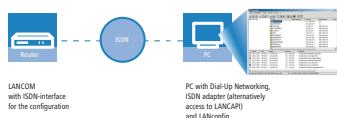

1. Establish a connection to the LANCOM with your PPP client using the following details:
 - User name 'ADMIN'
 - The password selected in LANCOM
 - An IP address for the connection, only if required
2. Open a Telnet session to the LANCOM. Use the following IP address for this purpose:

- '172.17.17.18', if you have not defined an IP address for the PPP client. The LANCOM automatically uses this address if no other address has been defined. The PC making the call will respond to the IP '172.17.17.17'.
- Raise the IP address of the PC by one, if you have defined an address. Example: You have set the IP '10.0.200.123' for the PPP client, the LANCOM then responds to '10.0.200.124'. Exception: If the digits '254' are at the end of the IP address, the router responds to 'x.x.x.1'.

3. You can configure the LANCOM remotely just like all other devices.

! Always provide additional protection for the settings of the device by setting a password. Alternatively, enter the following command during a Telnet or terminal connection:

```
passwd
```

You will then be prompted to enter and confirm a new password.

The default layer for remote field installations

The PPP connection of any other remote site to the router, of course, will only succeed if the device answers every call with the corresponding PPP settings. This is the case using the factory default settings because the default protocol (default layer) is set to PPP.

You may, however, want to change the default layer for LAN-to-LAN connections, for example, to a different protocol after the first configuration run. Then the device will no longer take calls on the dial-up connection using the PPP settings. The solution to this is to agree upon a special calling number for configuration access:

The administrator access for ISDN remote management

If the device receives a call on this number, it will always use PPP, regardless of any other settings made on the router. Only a specific user name which is automatically entered by the LANconfig program during call establishment will be accepted during the PPP negotiations:

1. Switch to the 'Admin' tab in the 'Management' configuration section.

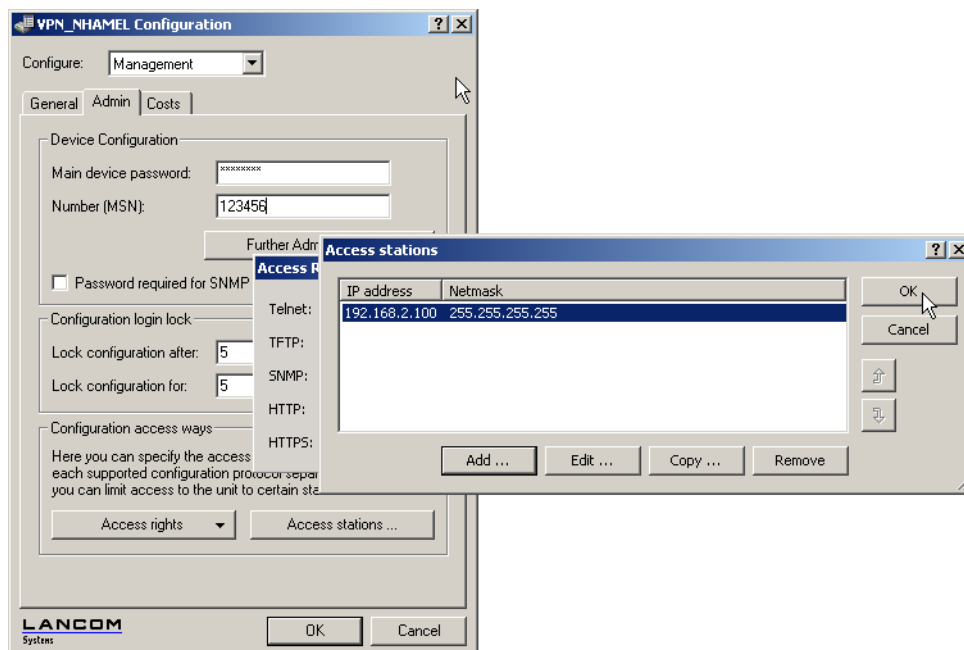

1. Enter a number (MSN) at your location which is not being used for other purposes in the 'Device Configuration' area.

Alternatively, enter the following command:

```
set /setup/config/Farconfig 123456
```



As long as no MSN is entered for the configuration access, a non-configured LANCOM accepts the calls on all MSNs. As soon as the first change is saved in the configuration, the device only takes calls on the configured MSN! If no MSN configuration is entered the remote access is switched off and the device is protected against access over ISDN.

3.9.6 Addition(s) to LCOS 8.80

Configurable SSH algorithms

The SSH implementation in the operating system of your device supports numerous cryptographic methods (algorithms). The devices can optionally restrict the choice of cryptographic methods to the algorithms of your preference.

Additions to the Setup menu

SSH

This item manages the mechanisms used for SSH encryption. You can select which algorithms are supported in both server and client mode.

SNMP ID:

2.11.28

Telnet path:

Setup > Config

Cipher algorithms

The cipher algorithms are used for encrypting and decrypting data. Select one or more of the available algorithms.

SNMP ID:

2.11.28.1

Telnet path:

Setup > Config > SSH

Possible values:

3DES-cbc

3DES-ctr

arcfour

arcfour128

arcfour256

blowfish-cbc

blowfish-ctr

aes128-cbc

aes192-cbc

aes256-cbc

aes128-ctr

aes192-ctr

aes256-ctr

Default:

3des-cbc,3des-ctr,arcfour,arcfour128,arcfour256,blowfish-cbc,blowfish-ctr,aes128-cbc,
aes192-cbc,aes256-cbc,aes128-ctr,aes192-ctr,aes256-ctr

MAC algorithms

MAC algorithms are used to check the integrity of messages. Select one or more of the available algorithms.

SNMP ID:

2.11.28.2

Telnet path:

Setup > Config > SSH

Possible values:

hmac-md5-96
hmac-md5
hmac-sha1-96
hmac-sha1
hmac-sha2-256-96
hmac-sha2-256
hmac-sha2-512-96
hmac-sha2-512

Default:

hmac-md5-96,hmac-md5,hmac-sha1-96,hmac-sha1,hmac-sha2-256-96,
hmac-sha2-256,hmac-sha2-512-96,hmac-sha2-512

Key exchange algorithms

The MAC key exchange algorithms are used to negotiate the key algorithm. Select one or more of the available algorithms.

SNMP ID:

2.11.28.3

Telnet path:

Setup > Config > SSH

Possible values:

diffie-hellman-group1-sha1
diffie-hellman-group14-sha1
diffie-hellman-group-exchange-sha1
diffie-hellman-group-exchange-sha256

Default:

diffie-hellman-group1-sha1,diffie-hellman-group14-sha1,
diffie-hellman-group-exchange-sha1,diffie-hellman-group-exchange-sha256

Host key algorithms

The host key algorithms are used to authenticate hosts. Select one or more of the available algorithms.

SNMP ID:

2.11.28.4

Telnet path:**Setup > Config > SSH****Possible values:**

ssh-rsa

ssh-dss

Default:

ssh-rsa,ssh-dss

Min host key length

This parameter defines the minimum length of your host keys.

SNMP ID:

2.11.28.5

Telnet path:**Setup > Config > SSH****Possible values:**

Max. 5 numbers

Default:

512

Max host key length

This parameter defines the maximum length of your host keys.

SNMP ID:

2.11.28.6

Telnet path:**Setup > Config > SSH****Possible values:**

Max. 5 numbers

Default:

8192

DH groups

The Diffie-Hellman groups are used for the key exchange. Select one or more of the available groups.

SNMP ID:

2.11.28.7

Telnet path:**Setup > Config > SSH****Possible values:**

Group 1

Group 5

Group 14

Group 15

Group 16

Default:

Group 1, group 5, group 14

File transfer via SCP

SCP (Secure Copy) is a protocol for the secure transfer of data between two computers in a network. Administrators often use SCP to exchange data between servers or between servers and workstations. With a suitable tool (e. g. the Putty add-on pscp.exe on Windows operating systems) you can also exchange data between your PC/notebook and a LANCOM device.

Download pscp.exe from the Putty download page to perform file transfer from a Windows operating system.

Then open a command line window using the command `cmd`.

Change to the directory where you have saved the file pscp.exe and run the following command to transfer a file from your Windows computer to the device. Enter the options `-scp` and `-pw` followed by your password:

```
C:\PortableApps\PuTTYPortable>pscp.exe -scp -pw ***** c:\path\myfile.ext
<User>@<IP-address>:target
```

Change the order of the source and destination, to transfer the file from the device to your computer:

```
C:\PortableApps\PuTTYPortable>pscp.exe -scp -pw *****
<User>@<IP-address>:target c:\path\myfile.ext
```

Enter the following command to save the configuration from the device to a file named `config.lcs` on your computer:

```
C:\PortableApps\PuTTYPortable>pscp.exe -scp -pw *****
root@123.123.123.123:config c:\config.lcs
```

To upload a new firmware file from your computer to the device, enter the following command:

```
C:\PortableApps\PuTTYPortable>pscp.exe -scp -pw ***** c:\firmware.upx
root@123.123.123.123:firmware
```

The following table specifically shows which files you can read via SCP from the device and which ones you can write to it:

Tabelle 1: Files for the SCP file transfer

Target	Read	Write	Description
ssl_cert	Yes	Yes	SSL – certificate (*.pem, *.cert, *.cer [BASE64])
ssl_privkey		Yes	SSL – private key (*.key [BASE64 unencrypted])
ssl_rootcert	Yes	Yes	SSL – root CA certificate (*.pem, *.cert, *.cer [BASE64])
ssl_pkcs12		Yes	SSL – container as PKCS#12 file (*.pfx, *.p12)
ssh_rsakey		Yes	SSL – RSA key (*.key [BASE64 unencrypted])
ssh_dsakey		Yes	SSL – DSA key (*.key [BASE64 unencrypted])
ssh_authkeys		Yes	SSH – accepted public key
vpn_rootcert	Yes	Yes	VPN – root CA certificate (*.pem, *.cert, *.cer [BASE64])

3 Configuration and management

Target	Read	Write	Description
vpn_devcert	Yes	Yes	VPN – device certificate (*.pem, *.crt. *.cer [BASE64])
vpn_devprivkey		Yes	SSL – private device key (*.key [BASE64 unencrypted])
vpn_pkcs12		Yes	VPN – container (VPN1) as PKCS#12 file (*.pfx, *.p12)
vpn_pkcs12_2		Yes	VPN – container (VPN2) as PKCS#12 file (*.pfx, *.p12)
vpn_pkcs12_3		Yes	VPN – container (VPN3) as PKCS#12 file (*.pfx, *.p12)
vpn_pkcs12_4		Yes	VPN – container (VPN4) as PKCS#12 file (*.pfx, *.p12)
vpn_pkcs12_5		Yes	VPN – container (VPN5) as PKCS#12 file (*.pfx, *.p12)
vpn_pkcs12_6		Yes	VPN – container (VPN6) as PKCS#12 file (*.pfx, *.p12)
vpn_pkcs12_7		Yes	VPN – container (VPN7) as PKCS#12 file (*.pfx, *.p12)
vpn_pkcs12_8		Yes	VPN – container (VPN8) as PKCS#12 file (*.pfx, *.p12)
vpn_pkcs12_9		Yes	VPN – container (VPN9) as PKCS#12 file (*.pfx, *.p12)
vpn_add_cas		Yes	VPN - add additional CA certificates (*.pfx, *.p12, *.pem, *.crt. *.cer [BASE64])
eaptls_rootcert	Yes	Yes	EAP/TLS – root CA certificate (*.pem, *.crt. *.cer [BASE64])
eaptls_devcert	Yes	Yes	EAP/TLS – device certificate (*.pem, *.crt. *.cer [BASE64])
eaptls_privkey		Yes	EAP/TLS – private device key (*.key [BASE64 unencrypted])
eaptls_pkcs12		Yes	EAP/TLS – container as PKCS#12 file (*.pfx, *.p12)
radsec_rootcert	Yes	Yes	RADSEC – root CA certificate (*.pem, *.crt. *.cer [BASE64])
radsec_devcert	Yes	Yes	RADSEC – device certificate (*.pem, *.crt. *.cer [BASE64])
radsec_privkey		Yes	RADSEC – private device key (*.key [BASE64 unencrypted])
radsec_pkcs12		Yes	RADSEC – container as PKCS#12 file (*.pfx, *.p12)
radius_accnt_total	Yes	Yes	RADIUS server – summary accounting (*.csv)
scep_cert_list	Yes	Yes	SCEP-CA – certificate list
scep_cert_serial	Yes	Yes	SCEP-CA – serial number
scep_ca_backup	Yes		Backup for SCEP-CA – PKCS12 container

Target	Read	Write	Description
scep_ra_backup	Yes		Backup for SCEP-CA – PKCS12 container
scep_ca_pkcs12		Yes	SCEP-CA – PKCS12 container
scep_ra_pkcs12		Yes	SCEP-CA – PKCS12 container
pbspot_template_welcome	Yes	Yes	Public Spot – welcome page (*.html, *.htm)
pbspot_template_login	Yes	Yes	Public Spot – login page (*.html, *.htm)
pbspot_template_error	Yes	Yes	Public Spot – error page (*.html, *.htm)
pbspot_template_start	Yes	Yes	Public Spot – home page (*.html, *.htm)
pbspot_template_status	Yes	Yes	Public Spot – status page (*.html, *.htm)
pbspot_template_logoff	Yes	Yes	Public Spot – logoff page (*.html, *.htm)
pbspot_template_help	Yes	Yes	Public Spot – help page (*.html, *.htm)
pbspot_template_noproxy	Yes	Yes	Public Spot – no proxy page (*.html, *.htm)
pbspot_template_voucher	Yes	Yes	Public Spot – voucher page (*.html, *.htm)
pbspot_template_agb	Yes	Yes	Public Spot – GTC page (*.html, *.htm)
pbspot_formhdrimg	Yes	Yes	Public Spot – header image pages (*.gif, *.png, *.jpeg)
WLC_Script_1.lcs	Yes	Yes	CAPWAP – WLC_Script_1.lcs
WLC_Script_2.lcs	Yes	Yes	CAPWAP – WLC_Script_2.lcs
WLC_Script_3.lcs	Yes	Yes	CAPWAP – WLC_Script_3.lcs
default_pkcs12		Yes	
rollout_wizard		Yes	
rollout_template		Yes	
rollout_logo		Yes	
hip_cert_0		Yes	
issue	Yes	Yes	Text for display after command-line login (e.g. ASCII logos)
config	Yes	Yes	Device configuration
firmware		Yes	Firmware update

3.10 Working with configuration files

The current configuration of a LANCOM can be saved as a file and reloaded in the device (or in another device of the same type) if necessary.

Additionally, configuration files can be generated and edited offline for any LANCOM device, firmware option and software version:

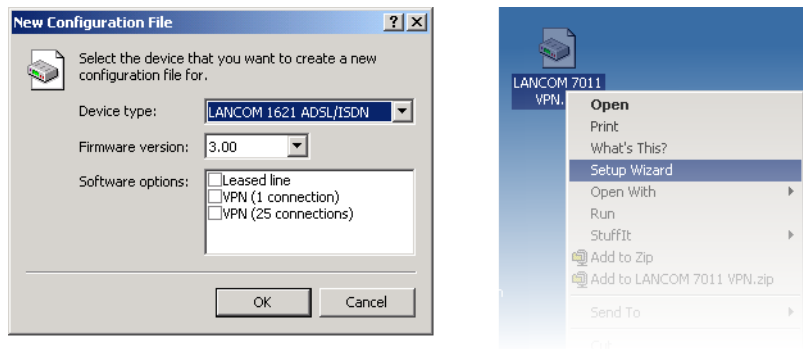

3.10.1 Backup copies of configuration

With this function you can create backup copies of the configuration of your LANCOM.

3.10.2 Convenient series configuration

However, even when you are faced with the task of configuring several LANCOM of the same type, you will come to appreciate the function for saving and restoring configurations. In this case you can save a great deal of work by first importing identical parameters as a basic configuration and then only making individual settings to the separate devices.

3.10.3 Running function

LANconfig:

Device / Configuration Management / Save to File Device / Configuration Management / Restore from File Edit / New Configuration File Edit / Edit Configuration File Device / Configuration Management / Print ...

WEBconfig: Save Configuration / Load Configuration (in main menu)

3.11 New firmware with FirmSafe

New with LCOS 7.60:

- Asymmetric firmsafe

3.11.1 This is how FirmSafe works

FirmSafe makes the installation of the new software safe: The used firmware is not simply overwritten but saved additionally in the device as a second firmware. Therewith your device is protected against the results of a power blackout or a disconnection while installing the firmware.

Of the two firmware versions saved in the device only one can ever be active. When loading a new firmware version the active firmware version is not overwritten. You can decide which firmware will be activated after the upload:

- 'Immediate': The first option is to load the new firmware and activate it immediately. The following situations can result:
 - The new firmware is loaded successfully and works as desired. Then all is well.
 - The device no longer responds after loading the new firmware. If an error occurs during the upload, the device automatically reactivates the previous firmware version and reboots the device.
- 'Login': To avoid problems with faulty uploads there is the second option with which the firmware is uploaded and also immediately booted.
 - In contrast to the first option, the device will wait for the adjusted firmsafe timeout (using WEBconfig in the menu **LCOS menu tree / Firmware / Timeout-firmsafe**, using Telnet adjust with 'Firmware/Timeout-firmsafe') until it is logged on over Telnet, a terminal program or WEBconfig. Only if this login attempt is successful does the new firmware remain active permanently.
 - If the device no longer responds or it is impossible to log in, it automatically loads the previous firmware version and reboots the device with it.
- 'Manual': With the third option you can define a time period during which you want to test the new firmware yourself. The device will start with the new firmware and wait for the preset period until the loaded firmware is manually activated and therefore becomes permanently effective. Activate the new firmware using LANconfig with **Device / Firmware Management / Activate Firmware running in Test Mode**, using Telnet under 'firmware/firmsafe table' with the command 'set # active' (# is the position of the firmware in the firmsafe table). Using WEBconfig you can find the firmsafe table under **LCOS menu tree/ Firmware**.

The modus for the firmware upload can be adjusted using WEBconfig in the menu **LCOS menu tree / Firmware / Mode-firmsafe**, using Telnet under 'firmware/timeout firmsafe'. Using LANconfig select the modus when selecting the new firmware file.

-
- ⓘ It is only possible to upload a second firmware, if the device has enough memory for two firmware versions. Current firmware versions (in occasion with additional software options) may use up more than half of the available memory. In this case the asymmetric firmware is used.

3.11.2 Asymmetric Firmsafe

Because of large range of functions in the firmware, some models are unable to simultaneously store two complete versions of the firmware. These devices use the asymmetric Firmsafe. Here, the device always contains a complete version and a minimal version of the firmware. The minimal version normally remains unused, but it allows local access to the device after a failed upload of the complete firmware version (e.g. as a result of a power cut during the upload process) so as to load an executable version of the firmware onto the device. The minimal firmware can not be configured. Changes in the configuration over LANconfig, WEBconfig or Telnet are not saved in the device

Advanced functions, such as remote administration, are not available whilst the minimal firmware is active. However, the LL2M server is also active in a minimal firmware version and offers access to the device provided it is reachable from an LL2M client over layer 2 (Ethernet).

Switching over to asymmetric Firmsafe

To switch devices to asymmetric Firmsafe, converter firmware is first loaded onto the device. This converts the firmware currently **not activated** in the device into a minimal firmware version, creating room for new and more comprehensive firmware. This process only has to be performed once.

You can then load a new, complete firmware version onto the device, which becomes active after a successful upload. The minimal firmware remains in the device to ensure that the device can be accessed.

Firmware upgrade with asymmetric Firmsafe

The subsequent firmware upload automatically overwrites the **active** firmware with new firmware.

3.11.3 How to load new software

There are various ways of carrying out a firmware upload, all of which produce the same result:

- LANconfig
- WEBconfig
- Terminal program
- TFTP

All settings will remain unchanged by a firmware upload. All the same you should save the configuration first for safety's sake (with **Device/ Configuration Management / Save to File** if using LANconfig, for example). Before uploading you should also save a version of the current firmware. If you do not have the firmware as a file, you can download it from www.lancom.de.

If the newly installed release contains parameters which are not present in the device's current firmware, the device will add the missing values using the default settings.

LANconfig

When using LANconfig, highlight the desired device in the selection list and click on **Device/ Firmware Upload**, or click directly on the **Firmware Upload** button. Then select the directory in which the new version is located and mark the corresponding file.

LANconfig then tells you the version number and the date of the firmware in the description and offers to upload the file. The firmware you already have installed will be replaced by the selected release by clicking **Open**.

You also have to decide whether the firmware should be permanently activated immediately after loading or set a testing period during which you will activate the firmware yourself. To activate the firmware during the set test period, click on **Edit/ Firmware Management**. After upload, start the new firmware in test mode.

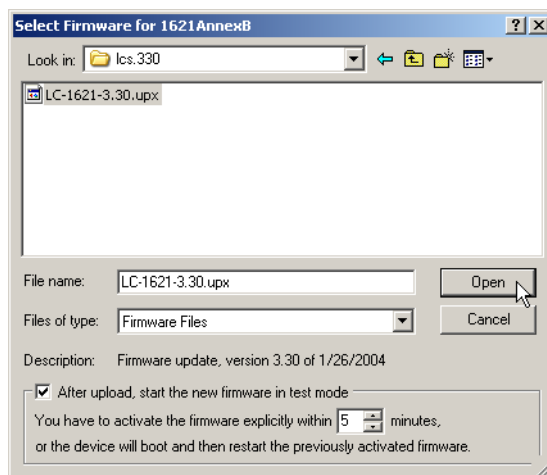

WEBconfig

Start WEBconfig in your web browser. On the starting page, follow the **Perform a Firmware Upload** link. In the next window you can browse the folder system to find the firmware file and click **Start Upload** to start the installation.

Terminal program (e.g. Telix or Hyperterminal in Windows)

If using a terminal program, you should first select the 'set mode-firmsafe' command on the 'Firmware' menu and select the mode in which you want the new firmware to be loaded (immediately, login or manually). If desired, you can also set the time period of the firmware test under 'set Timeout-firmsafe'.

Select the 'do Firmware-upload' command to prepare the router to receive the upload. Now begin the upload procedure from your terminal program:

- If you are using Telix, click on the **Upload** button, specify 'XModem' for the transfer and select the desired file for the upload.
- If you are using Hyperterminal, click on **Transfer/ Send File**, select the file, specify 'XModem' as the protocol and start the transfer with **OK**.



The firmware upload over a terminal program is only possible over a serial configuration interface.

TFTP

TFTP can be used to install new firmware on LANCOM. This can be done with the command (or target) **writeflash**. For example, to install new firmware in a LANCOM with the IP address 10.0.0.1, enter the following command under Windows 2000 or Windows NT:

- `tftp -i 10.0.0.1 put Lc_16xxu.282 writeflash`

Firmware upload via the serial interface with configuration reset

The serial interface can also be used to load firmware into the device. Entering the serial number instead of the configuration password results in the device configuration being reset to its ex-factory settings. In this way you can re-open the device in the case that the configuration password is lost and the reset button has been set to 'Ignore' or 'Boot only'.

1. Use the serial configuration cable to connect the device to a computer.
2. On the computer, start a terminal program such as Hyperterminal.
3. Open a connection with the settings 115200bps, 8n1, hardware handshake (RTS/CTS).
4. In the terminal program's welcome screen, press the Return key until the request to enter the password appears.

5. Enter the serial number that is displayed under the firmware version and press Return again.

```

FirmwareUpload - HyperTerminal
File Edit View Call Transfer Help
Outband-115200 Bit/s OK
#
| LANCOM L-54ag Wireless
| Ver. 7.26.0002 / 19.09.2007
| SN. 013020600159
| Copyright (c) LANCOM Systems
Connection No.: 001 (Outband-115200 Bps)
Password:
System is going down ...
@W@
▪ FLASHROM-Upload
| LANCOM L-54ag Wireless
| Copyright (C) LANCOM Systems
| Ver. 2.06.0001 / 22112006 / 16:30
Start Xmodem Upload
$_
Connected 0:01:41 Auto detect 115200 8-N-1 SCROLL CAPS NUM Capture Print echo

```

1. The device now expects a firmware upload. To initiate this, in Hyperterminal you click on **Transfer/ Send** file and select X-Modem as the transfer protocol.

 Uploading the firmware in this way completely deletes the configuration, which is returned to its ex-factory settings! Consequently, this option should only be used if the configuration password is no longer available.

3.12 Load files directly from a TFTP or HTTP server into the device

New in LCOS 7.60:

- Specification of server, path and file in URL notation
- Loading files into the device from an HTTP(S) server

Certain functions cannot be run satisfactorily, or not at all, via Telnet. These functions include those where entire files are transferred, such as the upload of firmware, and saving or restoring configuration data. TFTP or HTTP(S) is used in these cases.

3.12.1 TFTP

TFTP is available in Windows operating systems as standard. It enables the simple transfer of files to/from other devices over the network.

The syntax of the TFTP call is dependent on the operating system. The syntax under Windows:

- `tftp -i <IP address Host> [get|put] source [destination]`

 The ASCII format is pre-configured on many TFTP clients. Binary transmission therefore usually needs to be selected explicitly for the transfer of binary data (such as firmware). Parameter '-i' is used for this in this example under Windows.

If the device is password-protected, user name and password must be included in the TFTP command. The file name is either made up of the master password and the command to be executed (for supervisors), or of the combined user name and password separated by a colon (for local administrators), with the command as a suffix. A command sent by TFTP therefore resembles the following:

- <Master password><Command> or
- <User name>:<Password>@<Command>

The rights to use TFTP can be restricted for administrators—see also “Managing rights for different administrators”.

3.12.2 Loading firmware, device configuration or script via HTTP(S)

By supporting HTTP and in particular HTTPS, downloads of firmware, device configurations or scripts can also be used by LANCOM devices for automated processes (e.g. self-provisioning) that source files from the Internet. In practice it is far simpler to provide a central HTTPS server with a unique Internet address (URI) than a comparable TFTP server, and an existing Web server can be modified to offer this function.

A certificate used optionally for the HTTPS server is uploaded by WEBconfig to the device as the SSL root CA certificate:

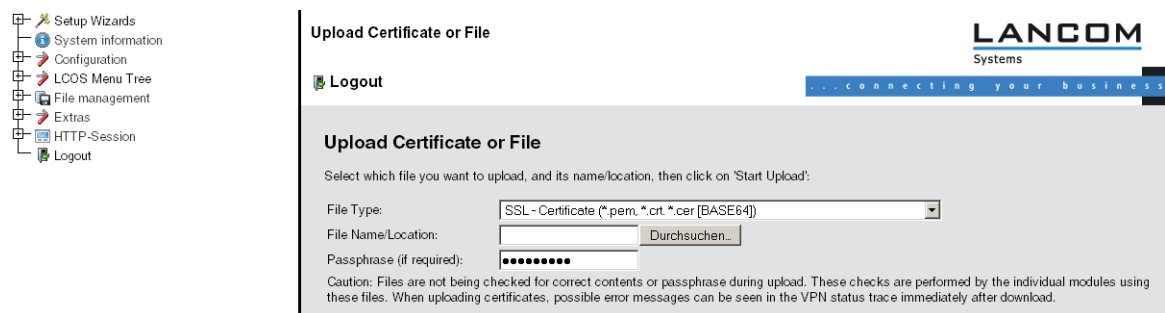

3.12.3 Loading firmware, device configuration or script via HTTP(S) or TFTP

Along with the option to load firmware or a configuration file into a device using LANconfig or WEBconfig, Telnet and SSH can also be used to directly upload the relevant files from an HTTP(S) or TFTP server. This process can simplify device administration in larger installations with regular firmware update and/or configuration. HTTP(S) and TFTP can also be used to load scripts (e.g. with partial configurations) into devices.

For this, the firmware and configuration files or scripts are stored on an HTTP(S) or TFTP server. A TFTP server is identical to an FTP server in terms of functionality, but uses a different protocol for data transmission. When using an HTTPS server, a certificate used to check the identity of the server can be stored on the device. The files can be retrieved from this server with the following commands:

- LoadConfig
- LoadFirmware
- LoadScript

The server, the directory and the file can be specified in two ways:

- By using the TFTP protocol with parameters -s and -f:
 - -s <Server IP address or server name>
 - -f <File path and file name>
- To use TFTP or HTTP(S), the command can be specified in the usual URL notation (either TFTP or HTTP(S) is entered as the protocol):
 - Command protocol://server/directory/file name

When accessing a password-protected area on an HTTP(S) server, user name and password are entered accordingly:

- Command protocol://user name:password@server/directory/file name

When using HTTPS, a certificate can be specified with which the identity of the server is checked.

- `-c <Certificate name>`

The following variables are permitted in the file name (including path):

- `%m` - LAN MAC address (hexadecimal, lowercase, no separators)
- `%s` - Serial number
- `%n` - Device name
- `%l` - Location (from the configuration file)
- `%d` - Device type

Examples:

The following Telnet command loads a firmware file named 'LC-1811-5.00.0019.upx' into the device from directory 'LCOS/500' on the server with IP address '192.168.2.200':

- `LoadFirmware -s 192.168.2.200 -f LCOS/500/LC-1811-5.00.0019.upx`

The following command in a Telnet session loads a script consistent with the MAC address from the server with IP address '192.168.2.200' into the device:

- `LoadScript -s 192.168.2.200 -f %m.lcs`

The following command in a Telnet session loads into the device a firmware file named 'LC-1811-5.00.0019.upx' from directory 'download' on the HTTPS server with IP address 'www.myserver.com'. The identity of the server is checked with the "sslroot.crt" certificate.

- `LoadFirmware -c sslroot.crt
https://www.myserver.com/download/LC-1811-5.00.0019.upx`

If the parameters `-s` and/or `-f` are not specified, the device uses default values set in path `/setup/config/TFTP-Client`:

- Config address
- Config file name
- Firmware address
- Firmware file name

These default values can be used if the latest configurations and firmware versions are always stored under the same name in the same location. In this case, the simple commands `LoadConfig` and `LoadFirmware` can be used to load the relevant files.

3.13 How to reset the device?

If you have to configure the device regardless of possible existing settings, or if a connection to the device configuration failed, you can put back the device into the factory default state with a **Reset**. To do so, **push** the **Reset button** until the device LEDs will light up (approx. 5 seconds).

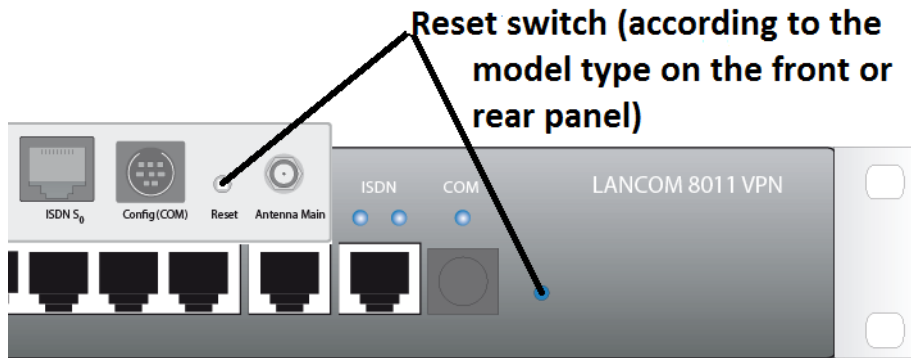

⚠ After applying the reset, the device will start fresh with factory defaults. **All** settings will be lost. Therefore, you should save the current configuration if possible **before** the reset!

⚠ Please notice that also the WLAN encryption settings of the device will get lost in case of a reset and the standard WEP key comes into effect again. The wireless configuration of a device with WLAN interface will only succeed after a reset, if the standard WEP key is programmed into the WLAN adapter!

The reset button offers two basic functions—boot (restart) and reset (to the factory settings)—which are called by pressing the button for different lengths of time.

Some devices simply cannot be installed under lock and key. There is consequently a risk that the configuration will be deleted by someone pressing the reset button too long. With the suitable setting, the behavior of the reset button can be controlled accordingly (only for devices with serial configuration interface):

WEBconfig: LCOS Menu Tree / Setup / Config

- Reset button

This option controls the behavior of the reset button when it is pressed:

- Ignore: The button is ignored.

⚠ **Please observe the following notice:** The settings 'Ignore' or 'Boot only' makes it impossible to reset the configuration to the factory settings using the reset button. If the password is lost for a device with this setting, there is no way to access the configuration! In this case the serial communications interface can be used to upload a new firmware version to the device—this resets the device to its factory settings, which results in the deletion of the former configuration. Instructions on firmware uploads via the serial configuration interface are available here .

- Reset-or-boot (standard setting): Press the button briefly to restart the device. Pressing the button for 5 seconds or longer restarts the device and resets the configuration to its factory settings. All LEDs on the device light up continuously. Once the switch is released the device will restart with the restored factory settings.

⚠ After applying the reset, the device will start fresh with factory defaults. **All** settings will be lost. Therefore, you should save the current configuration if possible **before** the reset!

⚠ Please notice that also the WLAN encryption settings of the device will get lost in case of a reset and the standard WEP key comes into effect again. The wireless configuration of a device with WLAN interface will only succeed after a reset, if the standard WEP key is programmed into the WLAN adapter! After a reset, the

LANCOM access point returns to managed mode, in which case the configuration cannot be directly accessed via the WLAN interface!

3.14 Addition(s) to LCOS 7.80

3.14.1 Deactivating Ethernet interfaces

The Ethernet interfaces on any publicly accessible LANCOM device can potentially be used by unauthorized persons to gain physical access to a network. The Ethernet interfaces on the device can be disabled to prevent this.

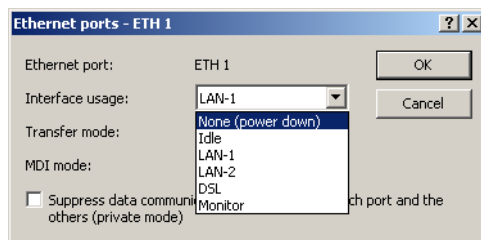

LANconfig: Interfaces / LAN / Interface settings

WEBconfig: LCOS menu tree / Setup / Interfaces

- Interface usage

Here you select how this interface is to be used.

Possible values:

- None (power down): The interface is deactivated.
- Idle: The interface is not allocated to any particular task, but it remains physically active.
- LAN-1 to LAN-n: The interface is allocated to a logical LAN.
- DSL-1 to DSL-n: The interface is allocated to a DSL interface.
- Monitor: The port is a monitor port, i.e. everything received at the other ports is output via this port. A packet sniffer such as Wireshark / Ethereal can be connected to this port, for example.

Default:

- Depends on the particular interface or the hardware model.

3.15 Addition(s) to LCOS 8.20

3.15.1 Automatic uploading of firmware, configuration and scripts

Introduction

Firmware, configuration or script files can be uploaded to a device in a number of ways. The management of large installations is facilitated by options for automatically uploading these files from a network or from an external storage drive when the device is started.

2.60 Autoload

This menu is used to set up the automatic uploading of firmware, configurations or scripts from external data media or from a URL.

Telnet path: /Setup/Autoload

2.60.1 Network

This menu is used to configure the automatic uploading of firmware, configurations or scripts over the network.

The settings made in this area are used when the commands LoadFirmware, LoadConfig or LoadScript are invoked from the command line. These commands upload firmware, configurations or scripts to the device using the TFTP or HTTP(S) client.

Telnet path: /Setup/Autoload/Network

 Loading firmware, configurations or scripts using the TFTP or HTTP(S) client can only succeed if the URL required to load the relevant file is fully configured and the URL is accessible when the command is executed. Alternatively, the URL can be entered as a parameter when the command is executed.

 The values for Condition, URL and Minimum-Version set under /Setup/Autoload/Network constitute default values. These values are only used in cases where no other appropriate parameters are entered when the commands LoadFirmware, LoadConfig or Load Script are invoked on the command line.

Parameters for the commands LoadFirmware, LoadConfig and LoadScript

The commands LoadFirmware, LoadConfig and LoadScript instruct the device to upload firmware or a configuration or to run a script. These commands are initiated from the command line. The parameters are used to control the behavior of the commands.

The parameters can be used in any combination. The only requirement is for a URL to be specified.

Values for condition, URL, or minimum version entered at the command line overwrite the values set under /Setup/Autoload/Network. Conversely, the values defined in the setup act to supplement the command-line commands if no parameters are entered manually.

The following parameters are of particular importance for automatic uploading:

- -Cn: This parameter checks if the firmware referenced by the command is **newer** than the firmware on the device.
- -Cd: This parameter checks if the firmware, configuration or script file referenced by the command is **different** to the firmware or configuration on the device, or newer than the last executed script. When the LoadScript command is used, this parameter updates the checksum stored in the device for the most recently executed script.
- -u: This parameter disables the version checking. The firmware, configuration or script file referenced by the command is uploaded and executed unconditionally. When the LoadScript command is used, this parameter does not change the checksum stored in the device for the most recently executed script.
- <URL>: This parameter specifies the storage location of the firmware, configuration or script file referenced by the command. The URL can take the form "tftp://foo", "http://foo" or "https://foo".
- -m: This value defines the minimum version of the firmware. The firmware referenced by the command must be at least of this version in order for the command LoadFirmware to execute.

The default setting for the conditions under /Setup/Autoload/Network are "Unconditionally". In the default setting, **no** version checking is carried out when the commands LoadFirmware and LoadConfig upload firmware, or when LoadScript executes a script file.

The parameter -u always has priority over other parameters entered in a command.

2.60.1.1 Firmware

This menu is used to configure the automatic uploading of firmware over the network.

Telnet path: /Setup/Autoload/Network/Firmware

2.60.1.1.1 Condition

This is where you select the condition under which the firmware specified under /Setup/Autoload/Network/Firmware/URL will be uploaded when the command LoadFirmware is executed.

Telnet path: /Setup/Autoload/Network/Firmware

Possible values:

- Unconditionally: The firmware will always be uploaded to and executed from the memory location of the inactive firmware. This setting deactivates version checking and the firmware specified will be uploaded in every case.
- If different: The firmware is uploaded to and executed from the memory location for the inactive firmware if it is of a different version to the firmware active in the device and the inactive firmware. If the specified firmware is of the same version as one of the two existing firmware versions, then the firmware will not be uploaded. The LoadFirmware command compares the firmware version (e.g. "8.10"), the release code (e.g. "RU1") and the file date.
- If newer: The firmware is uploaded and executed only if it is newer than the firmware currently active in the device. The firmware is only uploaded to the memory location for the inactive firmware if it is newer than the active and inactive firmware versions on the device. If the specified firmware is older than one of the two existing firmware versions, then it will not be uploaded.

Default: Unconditionally

 If the command LoadFirmware is executed twice in succession with the setting "unconditionally", both memory locations will contain the same firmware version.

2.60.1.1.2 Minimum version

Specify the minimum version of the firmware to be loaded over the network.

Telnet path: /Setup/Autoload/Network/Minimum-Version

Possible values:

- Max. 14 characters

Default: Blank

 Firmware versions with a lower version number will be ignored.

2.60.1.1.3 URL

Specify the URL of the firmware that is to be uploaded over the network using the LoadFirmware command.

Telnet path: /Setup/Autoload/Firmware/URL

Possible values:

- Max. 127 characters beginning with "tftp://", "http://" or "https://"

Default: Blank

 The TFTP or HTTP(S) client loads the file entered here only if the LoadFirmware command is entered without a URL as a parameter. A specific file at a known location can be loaded by entering its URL as a parameter.

2.60.1.2 Configuration

This menu is used to configure the automatic uploading of a configuration over the network.

Telnet path: /Setup/Autoload/Network/Configuration

2.60.1.2.1 Condition

This is where you select the condition under which the configuration specified under /Setup/Autoload/Network/Configuration/URL will be uploaded when the device is started.

Telnet path: /Setup/Autoload/Network/Configuration

Possible values:

- Unconditionally: The configuration will always be uploaded.
- If different: The configuration will only be uploaded if it has a different version number than the configuration that is currently active in the device.

Default: Unconditionally

2.60.1.2.3 URL

Specify the URL of the configuration that is to be uploaded over the network using the LoadConfig command.

Telnet path: /Setup/Autoload/Configuration/URL

Possible values:

- Max. 127 characters beginning with "tftp://", "http://" or "https://"

Default: Blank

 The TFTP or HTTP(S) client loads the file entered here only if the LoadConfig command is entered without additional parameters. Defining appropriate parameters when the command is invoked allows a specific file to be loaded.

2.60.1.3 Script

This menu is used to configure the automatic uploading of a script over the network.

Telnet path: /Setup/Autoload/Network/Script

2.60.1.3.1 Condition

This is where you select the condition under which the script specified under /Setup/Autoload/Network/Configuration/URL will be uploaded when the command LoadScript is executed.

Telnet path: /Setup/Autoload/Network/Script

Possible values:

- Unconditionally: The script will always be executed. This setting deactivates the checksum comparison and the specified script will always be uploaded unconditionally. In this case, the LoadScript command does not change the checksum for the most recently executed scripts as stored in the device.
- If different: The script will only be executed if it differs from the last executed script. The difference to the last executed script is determined using a checksum. For this the complete script is always uploaded. The LoadScript command then compares the checksum of the uploaded script with the checksum of the last executed script stored in the device. When the script is executed, the LoadScript command updates the checksum stored in the device.

Default: Unconditionally

2.60.1.3.3 URL

Specify the URL of the script that is to be uploaded over the network using the LoadFirmware command.

Telnet path: /Setup/Autoload/Script/URL

Possible values:

- Max. 127 characters beginning with "tftp://", "http://" or "https://"

Default: Blank

-  The TFTP or HTTP(S) client loads the file entered here only if the LoadScript command is entered without additional parameters. Defining appropriate parameters when the command is invoked allows a specific file to be loaded.

2.60.1.4 TFTP client

This menu contains the configuration for the TFTP client.

Telnet path: /Setup/Autoload/Network/TFTP-Client

2.60.1.4.1 Bytes per hashmark

This setting determines the number of bytes successfully loaded by the TFTP client after which a hash sign (#) is output on the command line when running LoadFirmware, LoadConfig or LoadScript. The TFTP client uses these hash marks to produce a progress bar when uploading firmware, configurations or scripts.

Telnet path: /Setup/Autoload/Network/TFTP-Client

Possible values:

- 4 characters

Default: 8192

-  This value is used only when loading with TFTP, not HTTP or HTTPS. With HTTP or HTTPS a hash mark is displayed at least every 100ms to display progress.

2.60.56 USB

This menu is used to configure the automatic uploading of firmware or configurations from external data media.

Telnet path: /Setup/Autoload/USB

2.60.56.1 Firmware and loader

This option activates the automatic loading of loader and/or firmware files from a connected USB medium. Save the required loader and/or firmware files in the "Firmware" directory located in the root directory of the connected USB media.

Telnet path: /Setup/Autoload/USB

Possible values:

- Inactive: Automatic loading of loader and/or firmware files is deactivated.
- Active: Automatic loading of loader and/or firmware files is activated. When a USB medium is mounted, a suitable loader and/or firmware file is uploaded to the device. The USB medium is mounted when it is plugged into the USB connector on the device, or when it is restarted.
- If-unconfigured Automatic loading of loader and/or firmware files is only activated when the device has its factory settings. A configuration reset can be used to return the device to its factory settings at any time.

Default:

- If-unconfigured

-  This option is set to "inactive" in the Security Settings Wizard or the Basic Settings Wizard.

2.60.56.2 Configuration and script

This option activates the automatic loading of configuration and/or script files from a connected USB medium. Save the required configuration and/or script files in the "Config" directory located in the root directory of the connected USB media.

Telnet path: /Setup/Autoload/USB

Possible values:

- Inactive: Automatic loading of configuration and/or script files is deactivated.
- Active: Automatic loading of configuration and/or script files is activated. When a USB medium is mounted, a suitable configuration and/or script file is uploaded to the device. The USB medium is mounted when it is plugged into the USB connector on the device, or when it is restarted.
- If-unconfigured Automatic loading of configuration and/or script files is only activated when the device has its factory settings. A configuration reset can be used to return the device to its factory settings at any time.

Default:

- If-unconfigured

 This option is set to "inactive" in the Security Settings Wizard or the Basic Settings Wizard.

 A device can be fed with an undesirable configuration by resetting it to its factory settings and inserting a prepared USB data media. To prevent this you have to deactivate the reset switch.

3.16 Addition(s) to LCOS 8.80

3.16.1 Setting the device time from GPS

From LCOS 8.80, you have the option of retrieving the time for the device via GPS automatically as an alternative to an NTP server or ISDN. Prerequisites for the obtaining the device time from GPS are:

- The operating mode of the 3G/4G modem is set to WWAN ([2.23.7.2 Operating](#))
- The GPS module is enabled ([2.40.1 Operating](#))
- The Fetch method for the device time is set to GPS ([2.14.1 Fetch method](#))

The current GPS time is to be found in LANmonitor ([Display of GPS time](#)) or the device status area ([1.63.3 Timestamp \(GPS\)](#)).

 This feature is available only on devices with internal WWAN module from Sierra. Please check the specifications for your model to see whether your device supports this function.

 The retrieval of GPS time requires an active SIM card in the device. The time is only available once the device has successfully gained a GPS fix. This requires the connection to at least four satellites in sufficient quality.

 The time received from GPS may differ by a few seconds from the actual time due to run-time variations and the non-observance of leap seconds in the GPS network.

Additions to the menu system

Additions to the Setup menu

Fetch method

Select here if and how the device synchronizes its internal real-time clock.

SNMP ID:

2.14.1

Telnet path:**Setup > Time****Possible values:**

None

ISDN

NTP

GPS

Default:

NTP

Operating

Select the operating mode for the interface.

SNMP ID:

2.23.7.2

Telnet path:**Setup > Interfaces > Mobile****Possible values:**

No

modem

WWAN

UMTS-GPRS

Default:

No

Operating

Activate or deactivate the GPS function here. You can activate the GPS module independently of the location verification function, for example to monitor the current positional coordinates with LANmonitor.

SNMP ID:

2.40.1

Telnet path:**Setup > GPS****Possible values:**

No

Yes

Default:

No

Additions to the Status menu**Timestamp (GPS)**

This entry shows the time that was last received from the GPS network.

SNMP ID:

1.63.3

Telnet path:

Status > GPS

4 Advanced management

4.1 Scripting

Installations with multiple LANCOM devices often profit from the automatic execution of certain configuration tasks. The scripting function in LANCOM enables entire sets of commands for device configuration to be stored in a single file—a script—for transfer to one or more devices in one step.

4.1.1 Applications

Scripting provides users with a powerful tool for the centralized configuration of LANCOM devices, and thus a wide range of potential applications:

- Read-out device configurations in a form that is easy to read and save

The configuration files generated by LANconfig are not intended for processing with other tools; users will only get an overview of the complete configuration from a print-out of the configuration file. The scripting functions can output the configuration as ASCII text to be saved as a text file.

- Edit the configuration with a simple text editor

If offline configuration with LANconfig is not possible or not desired, a configuration file generated by scripting can be edited with a text editor and then uploaded to the device again.

- Edit sections of the configuration

Instead of the entire configuration, smaller sections of it can be read out from a device instead (e.g. just the firewall settings). Just as with complete configurations, sections can be edited and transferred to one or more devices. This allows the particular settings in a device to be uploaded to other models or devices with a different version of the firmware.

- Automized configuration updates

The centralized storage of configuration scripts in combination with scheduled LCOS commands (cron jobs) can be used to keep vital sections of the configuration in multiple devices up to date, e.g. the encryption settings for a WLAN.

- Convenient roll-out for larger installations

The installation of multiple devices at different locations can be very easily controlled from a central location. Even employees without administrator rights can then set up the devices with a single command.

- Storage of configuration to volatile memory only

Scripting commands can store configuration changes in RAM only, whereby storage of configuration information to the non-volatile flash memory is prevented. This ensures that the configuration is available only until the next system boot, so that in case of theft, for example, sensitive elements of the configuration cannot fall into the wrong hands.

- Configuration changes in test mode

The same mechanism allows changes to the configuration in test mode. A script triggers a time-delayed system boot; the intervening time period can be used to change and test the device's configuration without risk. Should the changes lead to a failure, the device automatically reboots after the time delay and is reset to its original configuration.

Comparable to the FirmSafe function, this variation is a type of "ConfSafe". Changes to the configuration after a firmware update can, on occasion, be impossible to edit in the case of a later downgrade to an older firmware version. If, however, the configuration subsequent to the firmware upgrade is stored in test mode only, then downgrading and subsequently re-booting the system will result in the restoration of the original firmware **and** its configuration.

4.1.2 Scripting function

Scripting involves the collective transmission of a series of configuration commands to a LANCOM device just as if they were entered at a Telnet console (or similar). There are two variants of the collective transfer of configuration commands:

- The device is set to script mode by entering the command `beginscript` at the console. In this mode, the commands are not executed individually but are stored in an intermediate memory in the LANCOM. These commands are only executed after the command `exit` has been entered.
- Alternatively, the configuration commands are written offline to a script file (text file) and uploaded to the device as a complete script.

The configuration commands in the script file initially effect the configuration that is stored in the device's RAM only. The flash mode then determines whether or not the changes are to be made to the flash memory as well.

- In Flash Yes mode (standard), the configuration commands are directly written to the device's flash memory and are thus non-volatile (i.e. boot resistant). Since the flash mode is always ON with the other methods of configuration (console without script, LANconfig or WEBconfig), the configuration changes are written first to the RAM memory and then immediately to the flash memory.

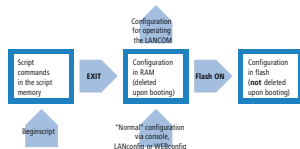

- In Flash No mode the data are written to RAM only and are thus available only until the next boot.
 - During the boot process, the device reads the configuration data from the flash memory.
 - The configuration in the RAM can be written to the flash memory at any time with the command "Flash Yes".

While operating, LANCOM devices work with the information stored in the RAM configuration. The script commands stored in the intermediate memory are, just like the configuration in the flash memory, of no relevance to the real-time operations of a LANCOM.

4.1.3 Generating script files

A script for a LANCOM configuration exists in the form of a conventional text file. These include any necessary comments and of the all of the commands as used e.g. with a Telnet console to set the configuration. There are two different ways to generate a script file:

- The script can be generated entirely with a text editor.
- The configuration, or a section of it, is read out of a device, stored as a script file and then altered with a suitable text editor.

Read out the configuration via the console

1. Log on to the console with Supervisor rights.
2. Switch to the branch of the configuration tree that you wish to read out.
3. At the command prompt, execute the command `readscript`. Observe the optional command extensions.
4. Using the Clipboard, copy and paste the required text section into a text editor and adapt the script to your requirements.

Via TFTP from the command line interface (DOS box)

The configuration commands can be read out directly from the command-line interface via TFTP.

1. To do this, open up a DOS box, for example.
2. Enter the following command at the prompt:

```
C:\>tftp IP address get "PASSWORDreadscript path" script.lcs
```

- IP address is the address of the device containing the configuration commands you wish to read out.
- PASSWORD is the appropriate password for the device.
- Path defines the branch of the configuration menu tree that is to be read out. If no path is entered then the entire configuration will be read out.
- script.lcs is the name of the script file in the current directory where the commands will be written to.

⚠ Please be aware that device passwords will be clearly visible as plain text while entering this command!

Via Hyperterminal

Terminal programs such as Hyperterminal provide an option of storing the text displayed by the console directly to a text file. This method is especially advantageous when dealing with larger configuration files as it avoids the potentially confusing method of using the Clipboard.

1. Set up a connection to the device with Hyperterminal.
2. Select the menu item **Transfer / Capture Text** and select the desired storage location and file name for the script.

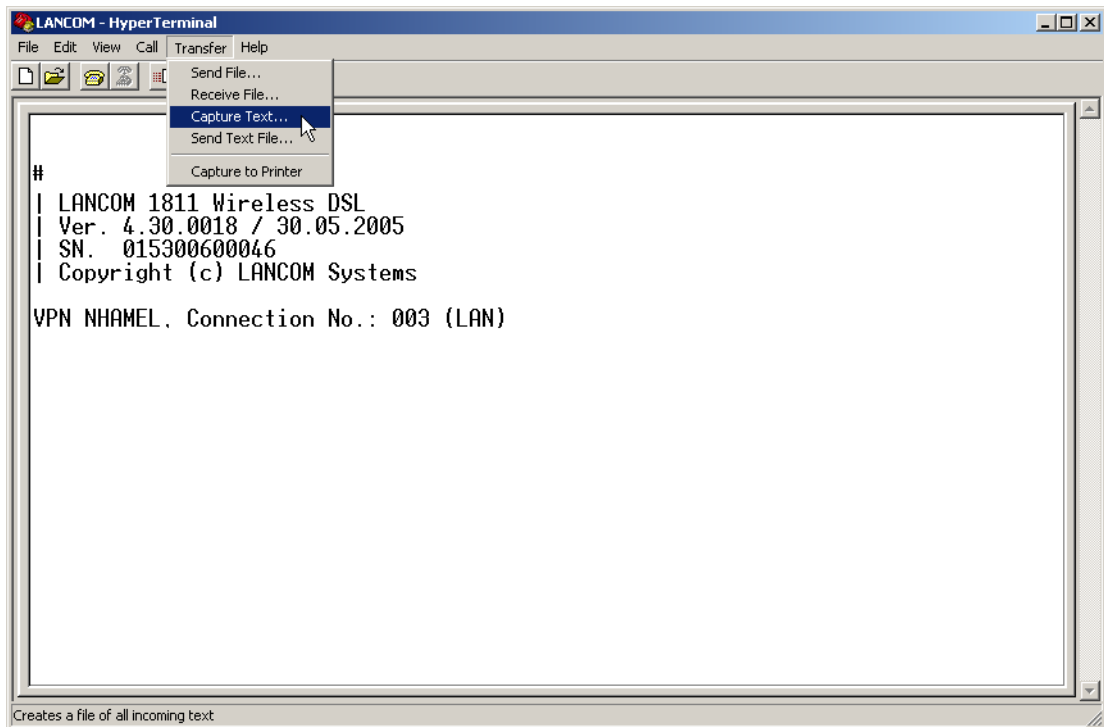

1. At the command prompt, execute the command `readscript`. Observe the optional command extensions.
2. As soon as you have called up all of the required sections of the configuration, stop the recording with the menu item **Transfer / Capture Text / Stop**.

The configuration commands are now available as a script file and can be altered as required.

Download script from device

Installations with multiple LANCOM devices often profit from the automatic execution of certain configuration tasks. The scripting function in LANCOM enables entire sets of commands for device configuration to be stored in a single file—a script—for transfer to one or more devices in one step.

⚠ Detailed information about scripting can be found under the section 'scripting' in the chapter on Network Management with LANtools in the reference manual.

In addition to manually setting a script and console read-outs, script files can also be read out from a device with the help of LANconfig. For this, right click on the corresponding entry in the device list and select the entry **Configuration management / Save script to file** from the context menu. Select the following options here:

- **Numeric sections**
Enable this option if you do not want the configuration sections in the script to be displayed in cleartext (e.g. `/setup/wlan/ppp`), but numerically (`/2/2/5`).
- **Default parameters**
Unless defined otherwise, the only parameters saved in a script are those that deviate from the default values. Enable this option if the standard values should also be entered into the script.
- **Column names**
Unless defined otherwise, the fields of a table are initially entered as column names in the scripts and, thereafter, only the respective values are inserted into the rows. Enable this option when every value in the table should explicitly receive the description of the column in which it is inserted.
- **Comments**
Activate this option when additional comments should be included in the script file.
- **Compact formatting**
 - Enable this option if spaces and tabs should be suppressed.
- **Download only selected sections**
Without further entries, the entire device configuration will always be saved in the script. In contrast, entering the sections also makes it possible to save partial configurations. Enter the sections to which the script should be transferred into this field, e.g. `/setup/wlan`.

4.1.4 Uploading configuration commands and script files

There are two basic methods of uploading the script commands to the intermediate memory of the LANCOM:

- The commands can be manually entered at a console in script mode (with the command "beginscript"). In this way the commands are written directly from the console to the intermediate memory. After all of the commands are ready, they are processed by entering the command "exit" and are then transferred to the RAM.
- The required command sequence can be saved to a text file. This text file is then sent to the intermediate memory by using an appropriate tool (LANconfig, terminal program, TFTP). If the necessary commands are included in the file, the transfer of the configuration to the RAM will be started automatically.

There are various ways to upload script files to LANCOM devices, the choice of which depends upon the configuration tool that you prefer to use.

Command input via console session (Telnet, SSH)

In a console session, a script can be uploaded to the device via the Clipboard:

1. Open your script with any text editor and transfer the configuration commands to the Clipboard.
2. Log on to the console with Supervisor rights.

3. Start the script mode with the command `beginscript`.

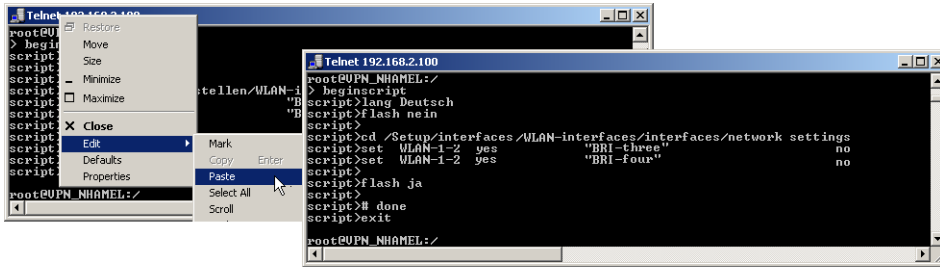

1. Paste the commands from the Clipboard following the script prompt (`script>`). In Telnet, for example, with a right mouse-click on the upper frame of the window.
2. Entering the command `exit` executes of the configuration commands.

 If the command `exit` is already included in the commands after pasting, the execution of the configuration will be carried out automatically immediately after pasting!

Upload script with TFTP client

During a console session (e.g. via Telnet or SSH), TFTP commands can be used to upload script files to the device directly from a TFTP server.

1. Log on to the console with Supervisor rights.
2. Enter the following command at the prompt:



```
>loadscript -s IP address -f script.lcs
```

 - IP address is the address of the TFTP server where the script file is stored.
 - script.lcs is the name of the script file on the TFTP server

Upload script with LANconfig

LANconfig has the option to upload a script either to a single device or to multiple devices simultaneously.

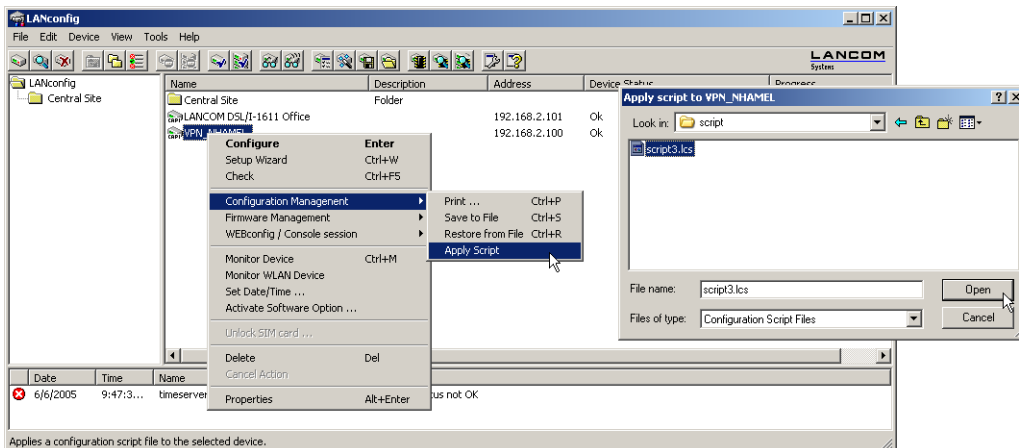
1. Click on a device with the right mouse key and use the context menu to select the entry **Configuration Management / ApplyScript**. If multiple devices are marked, the entry **ApplyScript** appears directly in the context menu.
2. In the following dialog, select the required script file (*.lcs) for upload.



- ! The upload of the script starts automatically. Status and error messages are either displayed directly by LANconfig or the can be viewed in a console session with the command `show script`.

Upload script with Hyperterminal

A further way to upload scripts to a LANCOM is to use a terminal program such as Hyperterminal as supplied with Windows.

1. Set up a connection to the device with Hyperterminal.
2. Select the menu item **Transfer / Capture Text**.
3. Choose the required script file and start the transfer.

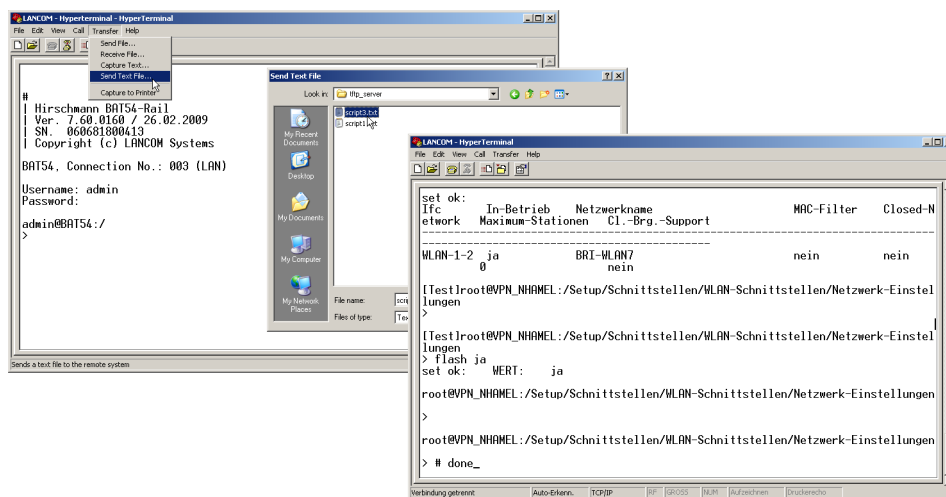

Following the successful completion of the transfer, the script is started automatically.

4.1.5 Multiple parallel script sessions

The LANCOM can manage multiple simultaneous script sessions. Just as multiple console sessions can be run simultaneously on a single device, different scripts can also access the LANCOM at the same time. Parallel script sessions are especially useful in the following scenarios:

- Script `initiates` a time-delayed reboot of the device after 30 minutes, for example. A second script `is` active during the device's run time and changes its configuration for test purposes; the flash mode is deactivated for this. If the changes in configuration from script `make` the device unattainable, then the restart prompted by script 30 minutes later causes these changes to be rejected.
- When using different scripts for partial configurations, multiple scripts can started simultaneously, for example with cron jobs. The individual configuration tasks do not need to be delayed until the previous script has completed its processing.

4.1.6 Scripting commands

- `readscript`

In a console session, the command `readscript` generates a text dump of all commands and parameters that are required for the configuration of the LANCOM in its current state. In the simplest case, the LANCOM lists only commands that are relevant to those parameters that no longer have the factory settings.

Syntax: `readscript [-n][-d][-c] [-m] [PATH]`



Supervisor rights are necessary to execute this command.

Example: For a LANCOM that is set up only for Internet-by-call via ISDN, the command `readscript` will produce the following console output (assuming that there are no further restrictions):

```
Telnet 192.168.2.101
#
: LANCOM DSL/I-1611 Office
: Ver. 4.30.0018 / 30.05.2005
: SN. 000590300000
: Copyright (c) LANCOM Systems
Connection No.: 002 <LAN>
root@:/
> readscript
# Head
lang English
Flash No

cd /Setup/WAN/Dialup-Remote-Peers
del *
add "DEFAULT" "" 20 20 ""
add "ARCOR" "0192070" 90 90 "ARCOR"
cd /Setup/WAN/Layer
del *
add "DEFAULT" TRANS PPP TRANS bnd+cmpr HDLC64K
add "T-ISDN" TRANS PPP TRANS none HDLC64K
add "MLPPP" TRANS PPP TRANS bnd+cmpr HDLC64K
add "PPPHDL" TRANS PPP TRANS none HDLC64K
add "RAWHDLC" TRANS TRANS TRANS none HDLC64K
add "T-DSL" TRANS PPP PPPoE none ETH
add "PPPoE" TRANS PPP PPPoE none ETH
add "IPOE" ETHER TRANS TRANS none ETH
add "DHCPOE" ETHER DHCP TRANS none ETH
add "U.24_DEF" TRANS PPP TRANS none SERIAL
add "ARCOR" TRANS PPP TRANS none HDLC64K
cd /Setup/WAN/PPP
del *
add "DEFAULT" PAP "" 0 5 ""
add "ARCOR" none "arcor" 0 5 "arcor"
set /Setup/LAN/Connector 32
set /Setup/TCP-IP/Intranet-Address 192.168.2.101
cd /Setup/IP-Router/IP-Routing-Table
del *
add 192.168.0.0 255.255.0.0 0 "0.0.0.0" 0 No
add 172.16.0.0 255.240.0.0 0 "0.0.0.0" 0 No
add 10.0.0.0 255.0.0.0 0 "0.0.0.0" 0 No
add 224.0.0.0 224.0.0.0 0 "0.0.0.0" 0 No
add 255.255.255.255 0.0.0.0 0 "ARCOR" 0 on
set /Setup/DHCP/Operating No
cd /Setup/Config/Access-Table
set LAN Yes Yes Yes Yes Yes Yes Yes
set WAN No No No No No No No
set /Setup/Mail/SMTP-Port 0
set /Setup/Mail/POP3-Port 0
set /Setup/Mail/Send-Again-(min.) 0
set /Setup/Mail/Hold-Time-(hrs.) 0
set /Setup/Mail/Buffers 0
flash Yes

# done
exit
root@:/
>
```

From this example it is possible to recognize the behavior or the script that was generated with the command `readscript`.

- First of all the parameters with values different from the default settings are displayed.
- The values in the tables are deleted (`del *`) and replaced with the current values in the configuration (`add *`).
- Only those table entries or values which cannot be left empty are directly changed with the `set` command.



The table lines or strings containing passwords are displayed in plain text as this is the format required by the Telnet user interface.

This script can be used to program other LANCOMs with exactly the same configuration as the original device.

As these scripts can be very long in some cases, it is possible to generate scripts that focus only on parts of the configuration. To do this, you first change to the directory with the configuration that is to be recorded (e.g. `cd set/ip-router/firewall` for the firewall settings) and then execute the `readscript` command. Alternatively, enter the path directly with the `readscript` command as a path parameter (e.g. `readscript set/ip-router/firewall`). In both cases, only the firewall settings that have been changed will be recorded in the script.

The following options can be used with the `readscript` command:

- `-d (default)`: The commands for modifying parameters that are set to the factory settings will be listed as well. These long scripts are useful for transferring configurations between different types of devices or between devices with different firmware versions as the factory settings can vary.
- `-n (numeric)`: This suffix causes the paths to be output in the numeric form of the SNMP description instead of plain text. This also facilitates the transfer of scripts between devices with different firmware versions as the path names may change but the SNMP tree generally does not.
- `-c (comment)`: In combination with `-d` and `-n`, this parameter generates additional comments which make the script easier to read. For the parameter `-d`, every command combination that sets a default value is marked with `# default value`. With `-n`, each numeric path is supplemented with its plain text equivalent.
- `-m (minimize)`: This parameter removes any gaps in the script, so making it more compact.

- `#`

The `#` character followed by a space at the start of a line are the first characters of a comment. Subsequent characters to the end of the line will be ignored.



The space after the `#` is obligatory.

- `del *`

This command deletes the table in the branch of the menu tree defined with `Path`.

Syntax: `del [PATH]*`

- `default`

This command enables individual parameters, tables or entire menu trees to be reset to their factory settings.

Syntax: `default [-r] [PATH]`

This command returns the parameters addressed by the `PATH` to their factory settings. If `PATH` indicates a branch of the menu tree, then the option `-r` (recursive) must be entered.



Supervisor rights are necessary to execute this command.

- `beginscript`

The command `beginscript` switches a console session into script mode. In this state, commands entered are not transferred directly to the LANCOM's configuration RAM but initially to the device's script memory. The commands will only be transferred to and started in the configuration RAM via a script session by executing the command `exit`.



Supervisor rights are necessary to execute this command.

- `show script`

The command `show script` displays the content of the most recently executed script and an overview of the currently running scripts. The names displayed in this output can be used to interrupt scripts early.

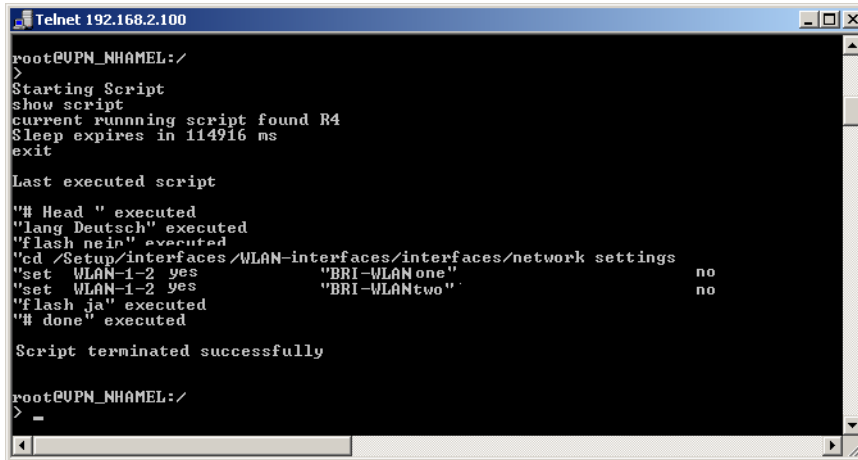

```

Telnet 192.168.2.100
root@UPN_NHAMEL:/
>
Starting Script
show script
current running script found R4
Sleep expires in 114916 ms
exit

Last executed script

"# Head " executed
"lang Deutsch" executed
"flash nein" executed
"cd /Setup/interfaces/WLAN-interfaces/interfaces/network settings
"set WLAN-1-2 yes          "BRI-WLANone"          no
"set WLAN-1-2 yes          "BRI-WLANtwo"          no
"flash ja" executed
"# done" executed

Script terminated successfully

root@UPN_NHAMEL:/
>

```

! Supervisor rights are necessary to execute this command.

■ `killscript`

The command `killscript` deletes the content of a script session that has not yet been executed. The script session is selected by its name.

! Supervisor rights are necessary to execute this command.

■ `flash Yes/No`

When configuring a device with scripts, any `add-`, `set-` or `del-` command can lead to an (unintentional) update of the configuration in flash; to prevent this, the update to flash function can be deactivated. After concluding the configuration, this function can be activated again with `flash Yes`. Changes in the RAM configuration are then written to flash. The status `flash Yes/No` is stored globally.

! Supervisor rights are necessary to execute this command.

■ `sleep`

The `sleep` command allows the processing of configuration commands to be delayed for a certain time period or to be scheduled for a certain time.

Syntax: `sleep [-u] value[suffix]`

Permissible suffixes are `s`, `m`, or `h` for seconds, minutes, or hours; if no suffix is defined, the units are milliseconds.

With the option switch `-u`, the `sleep` command accepts times in the format `MM/DD/YYYY hh:mm:ss` (English) or in the format `TT.MM.JJJJ hh:mm:ss` (German).

! Times will only be accepted if the system time has been set.

The `sleep` function is useful for a time-delayed reboot when testing an altered configuration or for a scheduled firmware update for large-scale roll-outs with multiple devices.

4.1.7 Addition(s) to LCOS 8.80

Tab command when scripting

When working with scripts, the `tab` command enables the desired columns for the subsequent `set` command.

When you perform the configuration with a command line tool, you generally supplement the set command with the values for the columns of the table.

For example, you set the values for the performance settings of a WLAN interface as follows:

```
> cd /Setup/Interfaces/WLAN/Performance
> set ?

Possible Entries for columns in Performance:
[1][Ifc]                : WLAN-1 (1)
[5][QoS]                : No (0), Yes (1)
[2][Tx-Bursting]       : 5 chars from: 1234567890

> set WLAN-1 Yes *
```

In this example the Performance table has three columns:

- Ifc, the desired interface
- Enable or disable QoS
- The desired value for TX bursting

With the command `set WLAN-1 Yes *` you enable the QoS function for WLAN-1, and you leave the value for TX bursting unchanged with the asterisk (*).

Working with the `set` command in this way is adequate for tables with only a few columns. However, tables with many columns can pose a major challenge. For example, the table under **Setup > Interfaces > WLAN > Transmission** contains 22 entries:

```
> cd /Setup/Interfaces/WLAN/Transmission
> set ?

Possible Entries for columns in Transmission:
[1][Ifc]                : WLAN-1 (1), WLAN-1-2 (16), WLAN-1-3 (17),
WLAN-1-4 (18), WLAN-1-5 (19), WLAN-1-6 (20), WLAN-1-7 (21), WLAN-1-8
(22)
[2][Packet-Size]       : 5 Chars from: 1234567890
[3][Min-Tx-Rate]       : Auto (0), 1M (1), 2M (2), 5.5M (4), 11M (6),
6M (8), 9M (9), 12M (10), 18M (11), 24M (12), 36M (13), 48M (14), 54M
(15)
[9][Max-Tx-Rate]       : Auto (0), 1M (1), 2M (2), 5.5M (4), 11M (6),
6M (8), 9M (9), 12M (10), 18M (11), 24M (12), 36M (13), 48M (14), 54M
(15)
[4][Basic-Rate]        : 1M (1), 2M (2), 5.5M (4), 11M (6), 6M (8), 9M
(9), 12M (10), 18M (11), 24M (12), 36M (13), 48M (14), 54M (15)
[19][EAPOL-Rate]      : Like-Data (0), 1M (1), 2M (2), 5.5M (4), 11M
(6), 6M (8), 9M (9), 12M (10), 18M (11), 24M (12), 36M (13), 48M (14),
54M (15), HT-1-6.5M (28), HT-1-13M (29), HT-1-19.5M (30),
HT-1-26M (31), HT-1-39M (32), HT-1-52M (33), HT-1-58.5M (34), HT-1-65M
(35), HT-2-13M (36), HT-2-26M (37), HT-2-39M (38), HT-2-52M (39), HT-2-78M
(40), HT-2-104M (41), HT-2-117M (42), HT-2-130M (43)
[12][Hard-Retries]    : 3 Chars from: 1234567890
[11][Soft-Retries]    : 3 Chars from: 1234567890
[7][11b-Preamble]     : Auto (0), Long (1)
[16][Min-HT-MCS]      : Auto (0), MCS-0/8 (1), MCS-1/9 (2), MCS-2/10
(3), MCS-3/11 (4), MCS-4/12 (5), MCS-5/13 (6), MCS-6/14 (7), MCS-7/15
(8)
[17][Max-HT-MCS]      : Auto (0), MCS-0/8 (1), MCS-1/9 (2), MCS-2/10
(3), MCS-3/11 (4), MCS-4/12 (5), MCS-5/13 (6), MCS-6/14 (7), MCS-7/15
(8)
[23][Use-STBC]        : No (0), Yes (1)
[24][Use-LDPC]        : No (0), Yes (1)
[13][Short-Guard-Interval] : Auto (0), No (1)
[18][Min-Spatial-Streams] : Auto (0), One (1), Two (2), Three (3)
[14][Max-Spatial-Streams] : Auto (0), One (1), Two (2), Three (3)
```

```
[15][Send-Aggregates] : No (0), Yes (1)
[22][Receive-Aggregates]: No (0), Yes (1)
[20][Max-Aggr.-Packet-Count] : 2 Chars from: 1234567890
[6][RTS-Threshold] : 5 Chars from: 1234567890
[10][Min-Frag-Len] : 5 Chars from: 1234567890
[21][ProbeRsp-Retries] : 3 Chars from: 1234567890
```

Use the following command to set the short guard interval in the transmission table for the WLAN-1-3 interface to No:

```
> set WLAN-1-3 * * * * * * * * * * * * * * No
```

 The asterisks for the values after the column for the short guard interval are unnecessary in this example, as the columns will be ignored when setting the new values.

As an alternative to this rather confusing and error-prone notation, you can use the `tab` command as the first step to determine which columns are changed with the subsequent `set` command:

```
> tab Ifc short guard-Interval
> set WLAN-1-3 No
```

The `tab` command also makes it possible to change the order of the columns. The following example for the WLAN-1-3 interface sets the value for the short guard interval to `No` and the value for `Use-LDPC` to `Yes`, although the corresponding columns in the table are displayed in a different order:

```
> tab Ifc short guard-Interval Use-LDPC
> set WLAN-1-3 No Yes
```

 The tables may only contain only a selection of the columns, depending on the hardware model. The `tab` command ignores columns which do not exist for that device. This gives you the option to develop unified scripts for different hardware models. The `tab` instructions in the scripts reference the maximum number of required columns. Depending on the model, the script only performs the `set` instructions for the existing columns.

You can also abbreviate the `tab` command with curly brackets. Use the following command to set the short guard interval in the transmission table for the WLAN-1-3 interface to No:

```
> set WLAN-1-3 {short-guard} No
```

The curly brackets also enable you to change the order of the columns. The following example for the WLAN-1-3 interface sets the value for the short guard interval to `No` and the value for `Use-LDPC` to `Yes`, although the corresponding columns in the table are displayed in a different order:

```
> set WLAN-1-3 {Short-Guard-Interval} No {Use-LDPC} Yes
```

4.2 Rollout Wizard

In complex scenarios with multiple LANCOM devices at different locations, on-site technicians may not be available to carry out the installation and configuration of a LANCOM. A large part of the configuration can be prepared at headquarters. All that has to be set up on-site are a few location-dependent parameters. The Rollout Wizard allows non-expert, on-site employees to carry out these last-minute adjustments with the help of a browser. After running the Rollout Wizard the device is either operational or it can independently retrieve the rest of its configuration from a central storage location.

The parameters for configuration can be found under the following paths:

WEBconfig: LCOS menu tree/ Setup/ HTTP / Rollout-Wizard

4.2.1 General settings in the Rollout Wizard

- Operating

Switches the Rollout Wizard on or off. After being switched on the Wizard appears directly on the WEBconfig start page.

- Possible values: On, off
- Default: Off

- Title

The name for the Rollout Wizard that appears on the start page of WEBconfig.

- Possible values: Maximum 64 alphanumerical characters
- Default: Roll-out

4.2.2 Variables

Maximum ten variables can be defined with Index, Ident, Title, Type, Min-Value, Max-Value and Default-Value.

- Index

Index for the variable. The Rollout Wizard displays the variables in ascending order.

- Possible values: 1 to 232 - 1
- Default: 0

- Ident

Unique identifier of variables that are referenced during the execution of actions. Identifiers are not required for fields that are not used by users to enter their data (e.g. label).

- Possible values: Maximum 64 alphanumerical characters
- Default: blank

- Title

Name of the variable as displayed by the Rollout Wizard in WEBconfig.

- Possible values: Maximum 64 alphanumerical characters
- Default: blank

- Type

Name of the variable as displayed by the Rollout Wizard in WEBconfig.

- Possible values: Label, Integer, String, Password, Checkmark
- Label: Text that is displayed to provide explanations of the other variables. Min.-Value and Max.-Value are of no further significance for these entries.
- Integer: Allows the entry of a positive integer number between 0 and 232 - 1. By entering the Min.-Value and Max.-Value, the range of entries can be limited. Also, a default value can be defined. This default value must be between the Min. and Max.-Values.
- String: Enables text to be entered. By entering the Min.-Value and Max.-Value, the length of the string can be limited. Also, a default value can be defined. This default text must be shorter than the maximum length, otherwise it will be truncated.
- Password: splayed while being entered. Entering a password has to be repeated. The Rollout Wizard will execute no actions if the passwords do not agree.
- Checkmark: Simple option that can be switched on or off. Min.-Value and Max.-Value are of no further significance for these entries. Checkmarks are activated as standard if the default value is not empty.
- Default: Label

- Min-Value

Minimum value for the current variable (if type = integer) or minimum number of characters (where type = String or Password).

- Possible values: 0 to 232 - 1
 - Default: 0
- Max-Value

Maximum value for the current variable (if type = integer) or maximum number of characters (where type = String or Password).

 - Possible values: 0 to 232 - 1
 - Default: 0
- Default value

Default value of the current variable.

 - Possible values: Maximum 64 alphanumerical characters
 - Default: blank

4.2.3 Actions to be executed by the Rollout Wizard

Max. 19 definitions of actions (with index and action) which are to be executed by the Rollout Wizard after the user data has been entered.

- Index

Index for the action. The Rollout Wizard executes the actions in ascending order.

 - Possible values: 1 to 232 - 1
 - Default: 0
- Action

Action to be executed by the Rollout Wizard after the user data has been entered.

 - Possible values: Similar to Cron commands, actions are entered in the syntax [Protocol:]Argument. If no protocol is entered, 'exec.' is applied.
 - exec: Executes any command just as it is used in Telnet to configure a LANCOM. The following example sets the name of the device to 'MyLANCOM':

```
exec: set /setup/name MyLANCOM
```

- mailto: Enables an e-mail to be sent upon entry of the address, subject and body text, for example:

```
mailto:admin@mylancom.de?subject=Rollout?body=LANCOM setup completed
```

 To make use of the mail function, an SMTP account must be set up in the device.

- http and http: Enables a Web site to be accessed, for example to carry out an action there.

```
<http:|http:>//[user[:pass]@]hostname[:port]/...
```

- Variables in the actions: When actions are executed, the values as defined with the Rollout Wizard can be referenced. To this end, the variable's identifier is used for the action with a leading percent character. The identifier must be enclosed by curly brackets if other alphanumeric characters are included in the action. The following example sets the name of the device to the format 'Site (branch)', if the location of the device is being queried as a variable with the identifier 'Location':

```
exec: set /setup/name %{Location}(Branch)
```

For variables of the type Integer or String, the value as entered by the user is used. In the case of variables of the type Checkmark, '1' (switched on) or '0' (switched off) is used.

 If the expression for the action contains spaces then the expression must be enclosed by quotation marks.

- Default: blank

4.2.4 Actions for managing the Rollout Wizard

- Renumber variables
- Renumber actions

As explained above, variables and actions are displayed or processed in the order of their index. Occasionally, variables/actions with neighboring index numbers require a new entry to be entered between them. With this action, the indices can automatically be renumbered with a certain interval between them.

When being executed, the arguments can be defined with the start value and increment. This action renumbers the entries starting with the start value and continuing with the increment as chosen. If the start value and increment are not defined, both are set automatically to 10. If no arguments are entered, the action renumbers the indices with 10, 20, 30, etc.

4.2.5 Addition(s) to LCOS 8.50

Custom Rollout Wizard

Introduction

In large-scale networking projects, administrators often have to install many devices of the same or similar type at different locations. To reduce or avoid the need to be personally present at the various locations, administrators often prepare the equipment at the central office for rollout. On location, an employee or a customer then runs a special wizard that sets the site-related parts of the configuration and puts the device into operation.

With a special instruction language, LCOS gives administrators the ability to define highly complex wizards. Custom wizards support the following functions:

- Definition of any internal variables
- Conditional branches
- Conditional goto instructions to any URL
- Conditional display of notices
- Runs all (non-interactive) actions that are available with the LCOS command line interface
- Read-out current values from the configuration in the devices
- Write new values to the configuration in the devices
- Status checks such as checking the time in the device
- Connection checks, e.g. the successful VPN connection to a specific remote site

In compliance with the rules of the instruction language, the administrator compiles a new Wizard in the form of a text file, which is then loaded into the device. The user on-site can run the custom wizard from WEBconfig by using the appropriate name.

 You can restrict certain administrator accounts to be available specifically under the Rollout Wizard only, allowing even inexperienced users to configure certain functions without allowing access to the complete configuration.

 At the time of the release of LCOS 8.50, users of the following devices can use the instruction language to customize wizards:

- LANCOM 1681V
- LANCOM 1711+ VPN
- LANCOM 1721+ VPN
- LANCOM 1821n Wireless
- LANCOM 1811n Wireless
- LANCOM 1751 UMTS

Structure of the custom wizard

The instructions that describe a custom wizard consist of the following sections:

- String tables with the necessary texts in English and German.
- A definition of the wizard.
- Any number of sections describing the HTML pages that the wizard is to display.
- An initialization section, which defines the actions when you start the wizard.
- A concluding section, which defines the actions when you stop the wizard.

Note the following conventions for the instructions that describe the wizard:

- The elements of the instructions exactly follow the structure given above.
- The text file with the instructions is encoded in ISO 8859-1.
- Comments start with a semicolon and serve only to improve the readability of the instructions.
- Internal variables begin with the key word `wizard`. (Including the dot) and store information for the internal processing of the wizard.
- Configuration variables begin with the keyword `config`. (including the dot) and read out information from the current device configuration, or they write them to the current configuration. Enter the configuration variables in one of the following forms:

- Dedicated parameters in the configuration are referenced via `config.1.<SNMP-ID>`, for example `config.1.2.1` to access the device name (to be found in the menu under `/setup/name`)



One way to find the SNMP-ID for a parameter in the configuration is to enter the command `ls -a` at the command line in the corresponding submenu.

- You can reference the values in a table with:

```
config.^.<SNMP-ID>.<Line>.ID:<Column>
```

Example for finding the value in the first line and the column with ID '2' in the routing table '1.2.8.2':

```
config.1.2.8.2.1.ID:2
```

- If you do not know the ID of the column, an alternative for you to reference the values in a table is to enter:

```
config.1.<SNMP-ID>.<Line>.<Column>
```

Example for finding the value in the first line and second column:

```
config.1.2.8.2.1.2
```

- If you do not know which line in the table you need, you can reference the values in a table via a known value in the first column:

```
config.<SNMP-ID>."<Known-Value>".ID:<Column>
```

Example for finding the value in the column with ID '2' on the line with the value of the default route in its first column:

```
config.1.2.8.2."255.255.255.0".ID:2
```

If the table contains multiple rows with the same value in the first column, then the configuration variable references the first of these lines.

- If the required line in the table is only defined after the user has entered input into the wizard, you can reference the value in the table by using a variable with:

```
config.<SNMP-ID>.\"<Internal-Variable>\".ID:<Column>
```

Example for finding the line whose first column contains a value that agrees with the current value of the internal variable `wizard.target_network`:

```
config.1.2.8.2."\wizard.target_network\".ID:2
```

- Device-property variables begin with the key word `device.` (including the dot) and are used to read-out specific properties from the device. For more information about the device variables, see the [Using device properties as variables](#).

String tables

The instructions for the custom wizard basically define the texts that are to be displayed in German and English.

The line `stringtable "English"` delivers the English text, the line `stringtable "German"` delivers the German texts. Each string definition consists of the keyword `string`, followed by the name of the string and the value enclosed by double inverted commas.

The following example shows the string tables with just one entry:

```
; -String tables start-----
  stringtable "English"
  string title_test, "Test wizard"
  stringtable "Deutsch"
  string title_test, "Test-Assistent"
; -String tables end-----
```

- ⓘ The interpreter of the instructions that describe the custom wizard in LCOS requires all texts to contain a German and an English definition. LCOS will not execute the wizard if an entry in the English string table is not accompanied by an entry of the same name in the German string table (or vice versa).

Definition of the wizard

The definition specifies the name of the wizard. The keyword `wizard` precedes the internal name in double inverted commas followed by the reference to an entry in the string table ([String tables](#)). The wizard displays the external name defined by this string when the HTML page is executed:

```
; -Wizard Definition Start-----
  wizard "My_Test-Wizard", title_test
; -Wizard Definition End-----
```

Sections

The sections represent the actual HTML pages that are displayed when the wizard is executed in the user's browser.

Each section begins with the keyword `section` and ends with the beginning of the next section. The last section ends at the beginning of the 'on-init' area, i.e. there is no explicit keyword for the end.

The sections include the following elements in any order and quantity:

- Conditions
- Optional freely definable name of the section, starting with the keyword `label`, followed by a string of upper- and lowercase letters and underscores '_':

```
Label My_RolloutAssistent
```

- ⓘ The instruction set for the wizard can use the freely definable name as a goto target.
 - Static text starting with the keyword `static_text` followed by a reference to an entry in the string table ([String tables](#)):
- ```
static_text str.conf_general
```
- Fields for different data types such as text or IP address, check boxes, radio buttons, selection lists, etc.
  - ⓘ Information on the various fields can be found in the ["Fields"](#) section.
  - Actions performed by the wizard in different situations depending on the keyword at the beginning of the block:

- `on_show`: The wizard performs the actions in this block before a section (HTML page) is displayed.
- `on_skip`: The wizard performs the actions in this block if a section (HTML page) is not to be displayed due to conditions contained within it.
- `on_next`: The wizard performs the actions in this block if the user clicks on 'Next' in the section (HTML page).
- `on_back`: The wizard performs the actions in this block if the user clicks on 'Back' in the section (HTML page).



Notes on the structure of the blocks with the actions and the elements in them are to be found in the [Actions](#) section.

### Conditions

You can specify any number of conditions for an element. Conditions in different lines are AND operators; conditions in one line are OR operators.

The instructions for the wizard can add conditions to any element in a section. Conditions always refer to the previous element. They consist of a class specifier and one or more condition patterns. A pattern consists of two operands and one operator.

If a condition contains multiple condition patterns in one line, the wizard evaluates this expression as an OR operator.

If the instructions contains multiple conditions relating to a parent element on separate lines, the wizard assesses the expression to be an AND operation.

The instructions can include the following classes:

- `only-if`: The preceding element is only executed or displayed when at least one of the following condition patterns is fulfilled.
- `skip-if`: The preceding element is not executed or displayed when all of the following condition patterns are fulfilled.

The condition pattern can contain the following operands:

- Static text
- Internal variables of the wizard
- Variables for referencing values from the current configuration of the device (configuration variables)
- The character '\*' as a wildcard

The condition pattern can contain the following operators:

- `equal`: Checks if the two operands are equal.
- `exists`: Checks if the specified configuration variable is set, i.e. that the value of the parameter in the configuration is not empty.
- `empty`: Checks if the first operand is empty. The second operand is specified as a wildcard '\*'.
- `contains`: Checks if the first operand contains the second operand.
- `!`: Negates the condition.

### Examples:

The following condition only displays the section if the internal variable 'wizard.test\_select' is equal to '0'.

```
section
only_if wizard.test_select, "0", equal
```

The following condition sets the internal variable 'wizard.intranet\_name' to the value 'INTRANET' if this variable is empty.

```
set wizard.intranet_name, "INTRANET" only_if wizard.intranet_name, *,
empty
```

The following condition sets the internal variable 'wizard.target\_1' to the value 'TARGET\_1' if the internal variable 'wizard.select\_target' is set either to '1' or '5'.

```
set wizard.target_1, "TARGET_1" only_if wizard.select_target, "1", equal,
wizard.select_target, "5", equal
```

## Fields and attributes

The wizard uses fields in order to display information to the user and to give the user the option to enter information. Each field corresponds to an internal variable.

The wizard defines a field by specifying the appropriate key word, followed by an internal variable on the same line. Additional lines that follow can optionally contain the attributes for the field.

An example of a field definition in the wizard:

```
selection_buttons select_inet
description str.inet_Selection
button_text str.inet_PPPE, str.inet_IPoE
```

This field generates a group of radio buttons, only one of which can be activated by the user. The wizard places the text defined in the string table `str.inet_Selection` as a description next to the field. For the radio buttons themselves, the wizard displays the text under `str.inet_PPPE` and `str.inet_IPoE`. After an option was selected by the user, the wizard writes the selected value to the internal variable `wizard.select_inet`.

You can use the following fields in the wizard:

`check_local_ip`: This field checks if the wizard previously changed the device's IP address and redirects the user to the corresponding HTML page. Possible attributes:

- `destination`: Target for forwarding as a FQDN or IPv4 address.
- `timeout`: Wait time before forwarding.

`check_time`: This field verifies if the device has valid time information. Possible attributes:

- `success_jump`: Label of the page that the wizard opens if the check is successful.
- `fail_jump`: Label of the page that the wizard opens if the check fails.
- `limit`: Maximum number of checks before the wizard considers the test to have failed. Set the limit to the value '0' to continue the checks without limit.
- `timeout`: Wait time between two checks.

`entryfield_hex`: This field is used for entering hexadecimal values, such as MAC addresses. Possible attributes:

- `description`: Field description in the HTML display
- `max_len`: Maximum number of characters that the user can enter into this field
- `never_empty`: A value of '1' for this attribute denotes a field that the user must fill out.
- `add_to_charset`: Adds extra characters to the default input character set.
- `default_value`: Default value

`entryfield_ipaddress`: This field is used to enter IPv4 addresses. Possible attributes:

- `description`: Field description in the HTML display
- `never_empty`: A value of '1' for this attribute denotes a field that the user must fill out.
- `never_zero`: A value of '1' for this attribute denotes a field that may not contain the value '0'.
- `add_to_charset`: Adds extra characters to the default input character set.
- `default_value`: Default value

`entryfield_numbers`: This field is used to enter telephone numbers. Possible attributes:

- `description`: Field description in the HTML display
- `max_len`: Maximum number of characters that the user can enter into this field
- `never_empty`: A value of '1' for this attribute denotes a field that the user must fill out.
- `add_to_charset`: Adds extra characters to the default input character set.
- `default_value`: Default value

`entryfield_numeric`: This field is used to enter numbers. Possible attributes:

- `description`: Field description in the HTML display

- `range_min`: Minimum value that the user can enter in this field
- `range_max`: Maximum value that the user can enter in this field
- `signed_value`: Allows you to specify a numerical value with a sign
- `never_empty`: A value of '1' for this attribute denotes a field that the user must fill out.
- `add_to_charset`: Adds extra characters to the default input character set.
- `default_value`: Default value
- `unit`: The unit of value shown after the input field in the wizard's HTML display.

`entryfield_text`: This field is used to enter text. The attribute `hidden` is for fields used to enter passwords. Possible attributes:

- `description`: Field description in the HTML display
- `hidden`: Identifies a field used by the user to enter a password.
- `add_to_charset`: Adds extra characters to the default input character set.
- `convert_to_upper`: Converts user input into uppercase letters
- `max_len`: Maximum number of characters that the user can enter into this field
- `min_len`: Minimum number of characters that the user can enter into this field
- `never_empty`: A value of '1' for this attribute denotes a field that the user must fill out.
- `unit`: The unit of value shown after the input field in the wizard's HTML display.

`entryfield_textwithlist`: This field is used to enter text. The user also has the option of selecting from a set of predefined values. Possible attributes:

- `description`: Field description in the HTML display
- `default_value`: Default value
- `max_len`: Maximum number of characters that the user can enter into this field
- `item_value`: List of predefined values that the user can select for this field

`onoff_switch`: This field creates a simple check box. Possible attributes:

- `description`: Field description in the HTML display
- `value_list`: List of the two values that the check box may take on
- `default_selection`: Default value

`page_switch`: This field creates a link with which the user can switch to one of the wizard's several other HTML pages. Possible attributes:

- `page_description`: Comma-separated list of text strings or references to strings that describe the possible link targets.
- `page_label`: Comma-separated list or page labels of the possible link targets.
- `description`: Field description in the HTML display

`ping_barrier`: This field stops the wizard from being executed until a ping to the target was answered successfully. Possible attributes:

- `destination`: Target address for the ping.
- `loopback`: Loopback address used by the ping instead of the default reply address
- `success_jump`: Label of the page that the wizard opens if the ping is successful.
- `fail_jump`: Label of the page that the wizard opens if the ping fails.
- `limit`: Maximum number of pings before the wizard considers the test to have failed. Set the limit to the value '0' to continue sending pings without limit.
- `timeout`: Wait time between two pings.

`popup`: This field opens the entered target address in a popup window. Possible attributes:

- None

 The target address can contain variables (see [Variables](#) on page 181).

`readonly_text`: This field creates a read-only field. The wizard can use these fields to display text. The wizard can use `hidden` attributes to define internal variables. Possible attributes:

- `description`: Field description in the HTML display
- `unit`: The unit of value shown after the input field in the wizard's HTML display
- `hidden`: Identifies a hidden field.

`selection_buttons`: This field generates a group of radio buttons, only one of which can be activated by the user. Possible attributes:

- `description`: Field description in the HTML display
- `button_text`: Comma-separated list of text strings or references to strings that describe the individual radio buttons.
- `button_value`: Comma-separated list of text strings with the values of the individual radio buttons.

`selection_list`: This field generates a drop-down selection list for the user to select a value. Possible attributes:

- `description`: Field description in the HTML display
- `item_text`: Comma-separated list of text strings or references to strings that describe the individual list entries.
- `item_value`: Comma-separated list of text strings with the values of the individual list entries.
- `default_selection`: Default value

`static_text`: This field creates static text on the HTML page following the field name as a reference to a text string. Possible attributes:

- None

## Variables

In some attributes of the fields you can use variables to replace the value of the attribute with another string or supplement it with an additional string.

to insert an internal variable into the value of an attribute, use the syntax `$(VariableName)`. To insert the user name from the internal variable `wizard.username` into a URL, add the following attribute:

```
http://host/directory?param=$(username)
```

To insert a predefined variable into the value of an attribute, use the syntax `%VariableName`. You can use the following predefined variables in the attributes:

- `%` inserts a percent sign.
- `f` inserts the version and the date of the firmware currently active in the device.
- `r` inserts the hardware release of the device.
- `v` inserts the version of the loader currently active in the device.
- `m` inserts the MAC address of the device.
- `s` inserts the serial number of the device.
- `n` inserts the name of the device.
- `l` inserts the location of the device.
- `d` inserts the type of the device.

## Actions

The wizard uses actions to change values in the device configuration.

One or more conditions can be defined for any action. If these conditions are met, the wizard performs the action.

**set**

Syntax:

- `set $target, $sourcelist`
- `set $target, $number, add`
- `set $target, $number, sub`

This action replaces the content of the target variable with the specified source. The source contains a comma-separated list of variables or text strings.

If the target variable is a single configuration parameter, specify only one value as the source. Other values are ignored.

If the target variable is a table, you should first specify the value in the source from the line that the wizard should change. The wizard searches the first index column for this value and it changes the first line in which it finds this value. If the wizard does not find a line with the matching value, it adds a new line to the table.

If the target variable is a numeric value, you can use the `add` or `sub` action to add or subtract the amount defined as `$number`.

**Examples**

The following action sets the default route to the desired values:

```
set config.1.2.8.2, "255.255.255.255", "0.0.0.0", "0", "INTERNET", "0",
"on", "Yes", ""
```

The following action increases the value of the ARP aging minutes to '5':

```
set config.1.2.7.11, "5", add
```

The following action reduces the value of the ARP aging minutes by '5':

```
set config.1.2.7.11, "5", sub
```

**del**

This action clears the contents of the target variable. If this variable is a table, enter the value from the first index column in the line that is to be deleted.

**Example**

The following action deletes the default route from the routing table:

```
del config.1.2.8.2, "255.255.255.0"
```

**cat**

This action lists the content of the source variables after the target variable.

**Example**

The following action adds the content of the variables `wizard.user` and the variable `wizard.name`:

```
cat wizard.name, wizard.user
```

**cut**

This action removes a certain number of characters from the target variables. Enter as a parameter the position of the character to be deleted counting from the left and, optionally, the number of characters to be deleted.

**Examples**

The following action will delete all characters in the variable `wizard.name` after the 2nd character.

```
cut wizard.name, 2
```

The following action will delete all characters in the variable `wizard.name` exactly 4 characters after the 2nd character.

```
cut wizard.name, 2, 4
```

### trigger\_config\_change

Depending on the part of the firmware that is affected, changes by the wizard to the configuration do not take immediate effect, as some modules use internal structures for the configuration.

The action `trigger_config_change` triggers an update to these internal structures. You should insert this action into a section if you want to make sure that the configuration has been updated when you change a page in the Rollout Wizard.

When you exit, the wizard automatically executes this action.

### exec

The string that follows this is executed as a command on the console. In this case variables can be used in the string, for example to start a LoadScript.

### Trace for rollout wizards

The HTML pages of the wizard only display the results of internal processing. While the wizard is being built, the trace can provide additional information to the administrator which could be used for further optimization, for example about the analysis of the various conditions.

Start trace from the command line using the command `trace + rollout-wizard`.

### Using user-defined HTML templates

An option, the appearance of the wizard can be adapted to your company's design guidelines by uploading a customized HTML template into the device. The template can specify the basic structure of HTML pages and the design of colors, fonts, etc. by means of CSS rules.

Two fixed tags in the HTML template are used to insert the contents from the wizard into the respective HTML pages:

- `<WIZARD_LOGO>`: The wizard inserts the logo (GIF, JPEG or PNG format) as saved to the device under 'WEBconfig/File management/Upload certificate or file'.
- `<WIZARD_CONTENT>`: This tag marks the point where the wizard inserts the contents of the sections in the form of a two-column table with the corresponding buttons.

A very simple example of an HTML template looks like this:

```
<!DOCTYPE HTML PUBLIC "-//W3C//DTD HTML 4.01//EN"
"http://www.w3.org/TR/html4/strict.dtd">
<html>
 <head>
 <title>Titel des Assistenten</title>
 <meta http-equiv="Content-Type" content="text/html;
charset=iso-8859-1">
 </head>
 <body>
 <div>
 <WIZARD_LOGO>
 </div>
 <WIZARD_CONTENT>
 </body>
</html>
```

The wizard a selection of predefined CSS classes that you can easily customize by specifying appropriate values in your HTML template, including:

- `class="header"`: The CSS class for the header with the logo.
- `class="wizardName"`: The CSS class paragraph with the name of the wizard at the head of the page.
- `class="headerLogo"`: The CSS class for the area for the logo in the header.
- `class="wizardTable"`: The CSS class for tables with the displayed fields.
- `class="footer"`: The CSS class for the footer with the buttons.

### Using device properties as variables

In some situations, a wizard has to make decisions based on the device properties. For instance, the wizard should only write certain values to the configuration if the device has a particular type of WAN interface. The wizard has access to certain variables of the device properties. These variables begin with the key word `device.` (including the dot), followed by the name of the relevant property. The wizard can use the following variables for read-access to the device properties:

`device.flags.dhcp_addr`: This variable indicates whether a DHCP server has assigned an IP address to the device (in which case the variable is set to '128 ') or not ('0').

`device.hasADSL`: This variable indicates whether the device has an ADSL interface ('1') or not ('0').

`device.hasISDN`: This variable indicates whether the device has an ISDN interface ('1') or not ('0').

`device.hasUMTS`: This variable indicates whether the device has an UMTS interface ('1') or not ('0').

`device.hasDSL`: This variable indicates whether the device has an DSL interface ('1') or not ('0').

`device.FirmwareVersion`: This variable indicates the current firmware version of the device.

`device.HardwareRelease`: This variable indicates the hardware release of the device.

`device.LoaderVersion`: This variable indicates the loader version of the device.

`device.MacAddress`: This variable indicates the MAC address of the device in hexadecimal notation without any separators.

`device.SerialNumber`: This variable indicates the serial number of the device.

`device.Location`: This variable indicates the location of the device as specified under `/setup/snmp`.

`device.DeviceString`: This variable indicates the type of the device.

`device.Name`: This variable indicates the name of the device as specified under `/setup`.

### Uploading files for the wizard

To make the wizard available, upload the following files to the device:

`Rollout-Assistent`: The instructions for compiling the wizard (required). This ISO-8859-1 encoded text file is required for operating the wizard. There is no limit on its size.

`Template-fuer-Rollout-Assistent (*.html, *.htm)`: An HTML template for the wizard (optional). This template controls the way that the sections appear in the HTML pages when the user's browser displays the wizard. The template allows you to use your own CSS information to define the layout. If you do not load a custom HTML template into the device, the wizard uses a predefined template. The template must not exceed a size of 64KB.

`Logo-fuer-Rollout-Assistent (*.gif, *.png, *.jpeg)`: Your company logo (optional). The wizard places this image file at the location of the `<WIZARD_LOGO>` marker in the template. If you do not load a logo into the device, the wizard uses a predefined logo.



Go to 'WEBconfig/File management/Upload certificate or file' to upload these files.

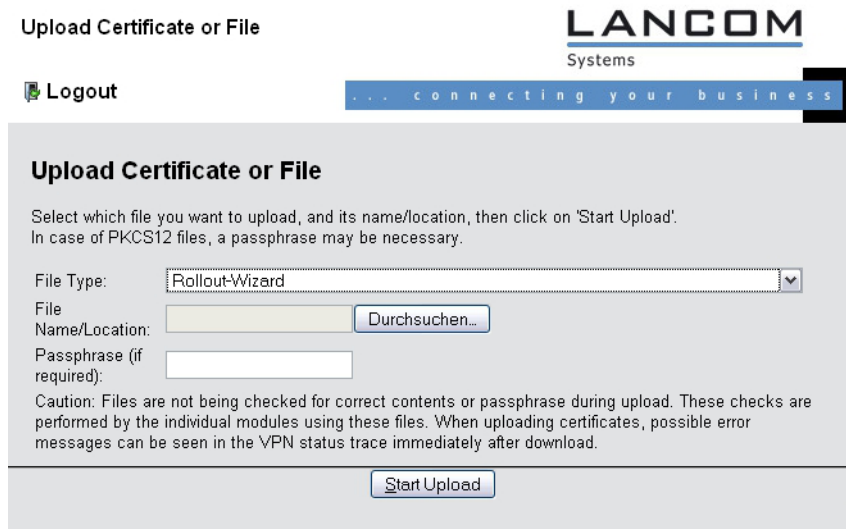

### Deleting wizard files from the device

To delete wizard files from the device, use the `remove` command. Certain parameters allow you to define which files are to be deleted:

```
rollout <action> [file]
```

Available actions:

- `-r`
- `-remove`

Available files:

- `all`: Deletes the wizard, the template and the logo
- `wizard`: Deletes the wizard
- `template`: Deletes the template
- `logo`: Deletes the logo

### The Rollout Wizard in the LCOS menu

The following parameters control the behavior of the Rollout Wizard.

#### Operating

Switches the Rollout Wizard on or off. After being switched on the Wizard appears as an option on the WEBconfig start page.

**Telnet path:** `/Setup/HTTP/Rollout-Wizard`

**Possible values:**

- `On`
- `Off`

**Default:** `Off`

#### Title

The name for the Rollout Wizard as displayed on the start page of WEBconfig.

**Telnet path:** /Setup/HTTP/Rollout-Wizard

**Possible values:**

- Max. 50 characters

**Default:** Rollout

#### Use extra checks

This option enables consistency tests that check some internal aspects of the wizard.

 Executing these additional tests is very time consuming. Activate this option only during development of the wizard and deactivate this option for normal operation.

**Telnet path:** /Setup/HTTP/Rollout-Wizard

**Possible values:**

- On
- Off

**Default:** Off

#### Starting the Rollout Wizard

To make the wizard available, upload the following files to the device:

Go to 'WEBconfig/File management/Upload certificate or file' to upload these files.

#### Example of a Rollout Wizard:

This section presents an example of a Rollout Wizard. The wizard is used for setting up an Internet connection.

In the first section, the wizard defines the text that the device provides for display on the various HTML pages.

```
stringtable "German"
 string title_MyCompany, "MyCompany Rollout"
 string txt_Welcome, "Welcome to the MyCompany Rollout Wizard"
 string dev_serial_number, "Serial number"
 string dev_type, "Device type"
 ;---Page: What type of connection string inet_Selection, "Internet
connection type" string inet_PPPE, "PPPoE" string inet_IPoE, "IPoE"
;---Page: IPoE
 string inet_ipoe, "Please enter the details for the connection."
 string con_ipaddress, "IP address"
 string con_subnet, "Net mask"
 string con_gateway, "Gateway"
 string con_dns, "DNS"
 ;---Page: PPPoE
 string inet_pppoe, "Please enter your username and password."
 con_username string, "username"
 string con_password, "password"
 --- Page: End
 string end, "The configuration is now complete."
```

The wizard starts the first line of the next section with the name 'MyCompany Rollout'. The device displays the text string `str.title_MyCompany` as the title of the HTML page.

The wizard then defines the sections, which correspond to the required HTML pages.

The 'Start' section first shows a static greeting text. Below that, the Wizard has two read-only fields that display the device type and serial number. The wizard reads out these two values from the device using the field `on_show` when it opens the page. The wizard offers the user a selection of options for the Internet connection, either 'PPPoE' or 'IPoE'.

Since no values are defined for the option fields, the wizard sets the variable `select_inet` according to the user's selection, e.g. PPPoE to '0' and IPoE to '1'.

```
wizard "MyCompany Rollout", str.title_MyCompany

section ;---Start---
 static_text str.txt_Welcome

 readonly_text device_string
 description str.dev_type
 readonly_text device_serial_number
 description str.dev_serial_number

 selection_buttons select_inet
 description str.inet_Selection
 button_text str.inet_PPPoE, str.inet_IPoE

on_show
 set wizard.device_string, device.DeviceString
 set wizard.device_serial_number, device.SerialNumber

on_next
```

172.23.56.254 - MyCompany Rollout

**LANCOM**  
Systems  
... connecting your business

**Welcome to the MyCompany Rollout Wizard**

Device Type: LANCOM 1711+VPN

Serial Number: 123831800176

Internet Connection:

PPPoE

IPoE

Back to Main-Page   Next >   Terminate this Wizard

The wizard only displays the IPoE section if the variable `select_inet` is set to the value '1'.

On this page, the wizard asks the user to provide values for the IP address, netmask, gateway and DNS server. All fields are required to run the wizard.

```
section ;---IPoE---
 only_if wizard.select_inet, "1", equal

 static_text str.inet_ipoe

 entryfield_ipaddress inet_ipaddress
 description str.con_ipaddress
 never_empty 1
 entryfield_ipaddress inet_subnet
 description str.con_subnet
 never_empty 1
 entryfield_ipaddress inet_gateway
 description str.con_gateway
 never_empty 1
 entryfield_ipaddress inet_dns
```

```
description str.con_dns
never_empty 1
```

172.23.56.254 - MyCompany Rollout

**LANCOM**  
Systems  
... connecting your business

Please insert the details for the connection.

IP Address  (max. 15 characters) (required)

Netmask  (max. 15 characters) (required)

Gateway  (max. 15 characters) (required)

DNS  (max. 15 characters) (required)

[Previous Page](#) [Next >](#) [Terminate this Wizard](#)

The wizard only displays the PPPoE section if the variable `select_inet` is set to the value '0'.

On this page of the wizard prompts the user for the user name and password, each with a maximum length of 30 characters.

```
section ;---PPPoE---
only_if wizard.select_inet, "0", equal

static_text str.inet_pppoe

entryfield_text inet_username
description str.con_username
max_len 30
entryfield_text inet_password
description str.con_password
max_len 30
```

172.23.56.254 - MyCompany Rollout

**LANCOM**  
Systems  
... connecting your business

Please insert username and Password.

Username  (max. 30 characters)

Password  (max. 30 characters)

[Previous Page](#) [Next >](#) [Terminate this Wizard](#)

The last page of the wizard initially displays a summary in static text. Follow-up actions are carried out when the wizard is finished:

- If the user has selected IPoE, the wizard creates a corresponding remote site and an entry in the list of IP parameters.
- If the user has selected PPPoE, the wizard creates a corresponding remote site and an entry in the PPP list.
- Whichever option is selected, the Wizard creates a default route 'INTERNET' in the router.

```

section ;---ende---
static_text str.ende

on_init ;---Befehle, die bei der Initialisierung des Wizards durchgeführt
werden.---

on_apply ;---Befehle, die bei der Fertigstellung des Wizards durchgeführt
werden.---

;---Wenn IPoE ausgewählt wurde, werden die entsprechenden Daten nun
eingetragen.
;---Remote site
set config.1.2.2.19, "INTERNET", "9999", "", "", "IPOE", "0",
"000000000000"
only_if wizard.select_inet, "1", equal
;---IP-Parameter
set config.1.2.2.20, "INTERNET", wizard.inet_ipaddress,
wizard.inet_subnet, "0.0.0.0", wizard.inet_gateway, wizard.inet_dns,
"0.0.0.0", "0.0.0.0", "0.0.0.0"
only_if wizard.select_inet, "1", equal

;---If PPPoE was selected, the corresponding data is entered.
;---Remote site
set config.1.2.2.19, "INTERNET", "9999", "", "", "PPPOE", "0",
"000000000000"
only_if wizard.select_inet, "0", equal
;---PPP list
set config.1.2.2.5, "INTERNET", "none", "60", wizard.inet_password,
"5", "5", "10", "5", "2", wizard.inet_username, "1"
only_if wizard.select_inet, "0", equal

;---Set the default route.
set config.1.2.8.2, "255.255.255.255", "0.0.0.0", "0", "INTERNET", "0",
"on", "Yes", ""

```

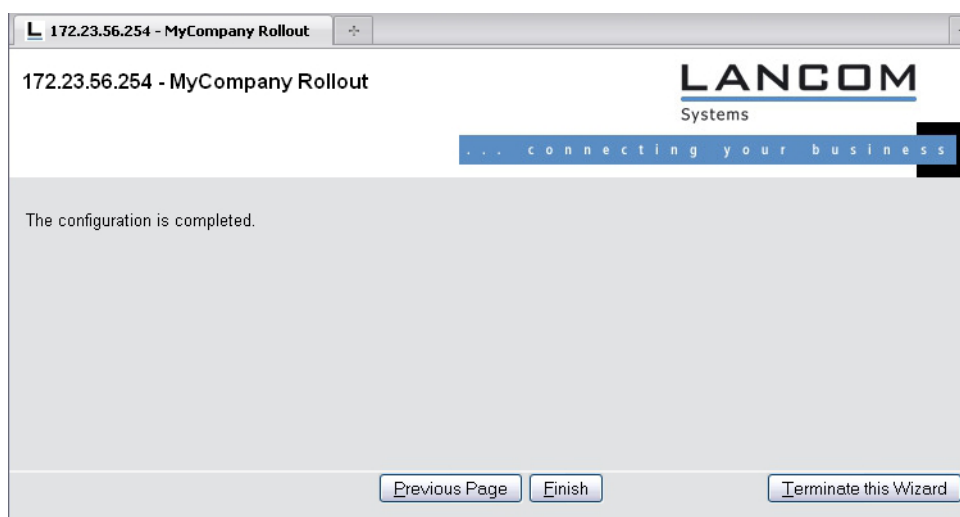

**Addition(s) to LCOS 8.60****Checking the system-time source in the customized Rollout Wizard**

The field `check_time` contains the new attribute `source` to verify the source of the system time.

**Fields and attributes**

The wizard uses fields in order to display information to the user and to give the user the option to enter information. Each field corresponds to an internal variable.

The wizard defines a field by specifying the appropriate key word, followed by an internal variable on the same line. Additional lines that follow can optionally contain the attributes for the field.

An example of a field definition in the wizard:

```
selection_buttons select_inet
description str.inet_Selection
button_text str.inet_PPPoE, str.inet_IPoE
```

This field generates a group of radio buttons, only one of which can be activated by the user. The wizard places the text defined in the string table `str.inet_Selection` as a description next to the field. For the radio buttons themselves, the wizard displays the text under `str.inet_PPPoE` and `str.inet_IPoE`. After an option was selected by the user, the wizard writes the selected value to the internal variable `wizard.select_inet`.

You can use the following fields in the wizard:

`check_local_ip`: This field checks if the wizard previously changed the device's IP address and redirects the user to the corresponding HTML page. Possible attributes:

- `destination`: Target for forwarding as a FQDN or IPv4 address.
- `timeout`: Wait time before forwarding.

`check_time`: This field verifies if the device has valid time information. Possible attributes:

- `success_jump`: Label of the page that the wizard opens if the check is successful.
- `fail_jump`: Label of the page that the wizard opens if the check fails.
- `limit`: Maximum number of checks before the wizard considers the test to have failed. Set the limit to the value '0' to continue the checks without limit.
- `timeout`: Wait time between two checks.
- `source`: The system-time source to be checked. If system time is obtained from another source, the test is evaluated as failed. Possible entries:
  - RAM
  - NTP
  - CAPWAP
  - RTC
  - ISDN
  - LANCONFIG
  - manual

`entryfield_hex`: This field is used for entering hexadecimal values, such as MAC addresses. Possible attributes:

- `description`: Field description in the HTML display
- `max_len`: Maximum number of characters that the user can enter into this field
- `never_empty`: A value of '1' for this attribute denotes a field that the user must fill out.
- `add_to_charset`: Adds extra characters to the default input character set.
- `default_value`: Default value

`entryfield_ipaddress`: This field is used to enter IPv4 addresses. Possible attributes:

- `description`: Field description in the HTML display
- `never_empty`: A value of '1' for this attribute denotes a field that the user must fill out.
- `never_zero`: A value of '1' for this attribute denotes a field that may not contain the value '0'.
- `add_to_charset`: Adds extra characters to the default input character set.
- `default_value`: Default value

`entryfield_numbers`: This field is used to enter telephone numbers. Possible attributes:

- `description`: Field description in the HTML display
- `max_len`: Maximum number of characters that the user can enter into this field
- `never_empty`: A value of '1' for this attribute denotes a field that the user must fill out.
- `add_to_charset`: Adds extra characters to the default input character set.
- `default_value`: Default value

`entryfield_numeric`: This field is used to enter numbers. Possible attributes:

- `description`: Field description in the HTML display
- `range_min`: Minimum value that the user can enter in this field
- `range_max`: Maximum value that the user can enter in this field
- `signed_value`: Allows you to specify a numerical value with a sign
- `never_empty`: A value of '1' for this attribute denotes a field that the user must fill out.
- `add_to_charset`: Adds extra characters to the default input character set.
- `default_value`: Default value
- `unit`: The unit of value shown after the input field in the wizard's HTML display.

`entryfield_text`: This field is used to enter text. The attribute `hidden` is for fields used to enter passwords. Possible attributes:

- `description`: Field description in the HTML display
- `hidden`: Identifies a field used by the user to enter a password.
- `add_to_charset`: Adds extra characters to the default input character set.
- `convert_to_upper`: Converts user input into uppercase letters
- `max_len`: Maximum number of characters that the user can enter into this field
- `min_len`: Minimum number of characters that the user can enter into this field
- `never_empty`: A value of '1' for this attribute denotes a field that the user must fill out.
- `unit`: The unit of value shown after the input field in the wizard's HTML display.

`entryfield_textwithlist`: This field is used to enter text. The user also has the option of selecting from a set of predefined values. Possible attributes:

- `description`: Field description in the HTML display
- `default_value`: Default value
- `max_len`: Maximum number of characters that the user can enter into this field
- `item_value`: List of predefined values that the user can select for this field

`onoff_switch`: This field creates a simple check box. Possible attributes:

- `description`: Field description in the HTML display
- `value_list`: List of the two values that the check box may take on
- `default_selection`: Default value

`page_switch`: This field creates a link with which the user can switch to one of the wizard's several other HTML pages. Possible attributes:

- `page_description`: Comma-separated list of text strings or references to strings that describe the possible link targets.
- `page_label`: Comma-separated list or page labels of the possible link targets.

- `description`: Field description in the HTML display

`ping_barrier`: This field stops the wizard from being executed until a ping to the target was answered successfully. Possible attributes:

- `destination`: Target address for the ping.
- `loopback`: Loopback address used by the ping instead of the default reply address
- `success_jump`: Label of the page that the wizard opens if the ping is successful.
- `fail_jump`: Label of the page that the wizard opens if the ping fails.
- `limit`: Maximum number of pings before the wizard considers the test to have failed. Set the limit to the value '0' to continue sending pings without limit.
- `timeout`: Wait time between two pings.

`popup`: This field opens the entered target address in a popup window. Possible attributes:

- None



The target address can contain variables.

`readonly_text`: This field creates a read-only field. The wizard can use these fields to display text. The wizard can use `hidden` attributes to define internal variables. Possible attributes:

- `description`: Field description in the HTML display
- `unit`: The unit of value shown after the input field in the wizard's HTML display
- `hidden`: Identifies a hidden field.

`selection_buttons`: This field generates a group of radio buttons, only one of which can be activated by the user. Possible attributes:

- `description`: Field description in the HTML display
- `button_text`: Comma-separated list of text strings or references to strings that describe the individual radio buttons.
- `button_value`: Comma-separated list of text strings with the values of the individual radio buttons.

`selection_list`: This field generates a drop-down selection list for the user to select a value. Possible attributes:

- `description`: Field description in the HTML display
- `item_text`: Comma-separated list of text strings or references to strings that describe the individual list entries.
- `item_value`: Comma-separated list of text strings with the values of the individual list entries.
- `default_selection`: Default value

`static_text`: This field creates static text on the HTML page following the field name as a reference to a text string. Possible attributes:

- None

## 4.3 LANCOM Layer 2 Management protocol (LL2M)

### 4.3.1 Introduction

As a pre-requisite for all methods of configuring a LANCOM, an IP connection must exist between the configuration computer and the LANCOM. No matter whether LANconfig, WEBconfig or Telnet is used, no configuration commands can be sent to the device without an IP connection. In the event of erroneous configuration of the TCP/IP settings or VLAN parameters, this IP connection may be impossible to establish. The only option in this case is to access the device via the serial configuration interface (not available on all devices) or to reset the device to its factory settings. However,



both options require physical access to the device—this may not always be the case for concealed installation of Access Points and can represent considerable overhead for larger-scale installations.

The LANCOM Layer 2 Management Protocol (LL2M) is used to also enable configuration access to a device even without an IP connection. All this protocol requires is a connection on layer 2 (i.e. via Ethernet directly or via layer-2 switches) to establish a configuration session. LL2M connections are supported on LAN or WLAN connections, but not via WAN. Connections via LL2M are password protected and are resistant to replay attacks.

LL2M establishes a client-server structure for this purpose: The LL2M client sends requests or commands to the LL2M server that responds to the requests or runs the commands. The LL2M client is integrated into LCOS and is run from the command line. The LL2M server is also integrated into LCOS and is usually only enabled for a brief period after device power-on. In this time frame, an administrator can use the LL2M client to perform changes to the configuration of the device running the LL2M server.

### 4.3.2 Configuration of the LL2M server

WEBconfig: LCOS Menu Tree/Setup/Config/LL2M

- Operating

Enables/disables the LL2M server. An LL2M client can contact an enabled LL2M server for the duration of the time limit following device boot/power-on.

Possible values:

- Yes, No

Default:

- Yes

- Time limit

Defines the period in seconds during which an enabled LL2M server can be contacted by an LL2M client after device boot/power-on. The LL2M server is disabled automatically after expiry of the time limit.

Possible values:

- 0 to 4294967295

Default:

- 0

Special values:

- 0 disables the time limit. The LL2M server stays permanently enabled in this state.

### 4.3.3 Commands for the LL2M client

For every LL2M command, an encrypted tunnel is set up that protects the log-in information transferred on transmission. To use the integrated LL2M client, start a Telnet session on a LANCOM that has local access to the LL2M server via the available physical medium (LAN, WLAN). The following commands can be used to contact the LL2M server in this console session.

---

 You must have root rights on the LL2M server to run commands on the LL2M client.

- LL2Mdetect

The LL2M client uses this command to send a SYSINFO request to the LL2M server. The server then sends its system information, such as hardware and serial number, back to the client for display. The LL2Mdetect command can be restricted using the following parameters.

- `-a <MAC address>`: Restricts the command to those devices with the specified MAC address only. The MAC address is specified in format "00a057010203", "00-a0-57-01-02-03" or "00:a0:57:01:02:03".



If no MAC limitations are set, the detect is sent as a multicast (or optionally as a broadcast) to all LL2M-compatible devices. To contact groups of MAC addresses, \* and x can be used as placeholders in individual MAC address positions, e.g. "00-a0-57-xx-xx-xx" for all LANCOM MAC addresses.

- `-t <device type>`: Restricts the command to those devices of the corresponding hardware type only.
- `-r <hardware release>`: Restricts the command to those devices with the corresponding hardware release only.
- `-f <version>`: Restricts the command to those devices with the corresponding firmware version only.
- `-s <serial number>`: Restricts the command to those devices with the corresponding serial number only.
- `-b`: Sends the LL2Mdetect request as a broadcast and not as a multicast.
- `-v <VLAN ID>`: Only sends the LL2Mdetect request on the VLAN specified. If no VLAN ID is specified, the VLAN ID of the first defined IP network is used.

Example:

- `ll2mdetect -r A`: This command sends a SYSINFO request to all devices with hardware release "A".

The response from the LL2M server contains the following information:

- Device name
  - Device type
  - Serial number
  - MAC address
  - Hardware release
  - Firmware version with date
- LL2Mexec

The LL2M client uses this command to send a single-line command to run on the LL2M server. Several commands can be combined in one LL2M command by using semicolons as separators. Depending on the command, either the actions are run on the remote device and the responses from the remote device are sent to the LL2M client for display. The LL2Mexec command conforms to the following syntax:

- `ll2mexec <user>[:<password>]@<MAC address>`

The LL2Mexec command can be restricted using the following parameters.

- `-v <VLAN ID>`: Only sends the LL2Mexec command on the VLAN specified. If no VLAN ID is specified, the VLAN ID of the first defined IP network is used.

Example:

- `ll2mexec root@00a057010203 set name MyLANCOM`: This command logs the LL2M client on to the LL2M server with MAC address "00a057010203" as user "root". The user is prompted for the password in the console session. The LL2M client then sets the name of the remote device to "MyLANCOM".

## 4.4 Messaging

The action table contains the following variables for control over messaging when certain events occur in the LANCOM:

- %a  
WAN IP address of the WAN connection relating to the action.
- %H  
Host name of the WAN connection relating to the action.

- %h  
as %h, except the hostname is in small letters
- %c  
Connection name of the WAN connection relating to the action.
- %n  
Device name
- %s  
Device serial number
- %m  
Device MAC address (as in Sysinfo)
- %t  
Time and date in the format YYYY-MM-DD hh:mm:ss

#### 4.4.1 Example: Broken connection alert as an SMS to a mobile telephone

The placeholder %t allows the current time of an event to be incorporated into a message. For example, an alert about the interruption of an important VPN connection can be sent by e-mail or as an SMS to a system administrator's mobile telephone.

The following requirements have to be met for messaging:

- The status of the VPN connection must be monitored, for example by means of "dead-peer-detection" (DPD).
- The LANCOM has to be configured as an NTP client in order to have the current system time.
- An SMTP account must be set up for transmitting e-mails.

Once these requirements are fulfilled, messaging can be set up. This is done with a new entry in the action table; e. g. with LANconfig under **Communication / General / Action table**.

The screenshot shows a dialog box titled "Action table - New Entry". It contains the following fields and values:

- Entry active
- Name: VPN-Site 1
- Remote site: VPN-Site 1
- Lock time: 0 seconds
- Condition: Broken
- Action: mailto:admin@mycompany.com?subject=VPN connection broken at %t?body=VPN connection to Subsidiary 1 was broken.
- Result-Check: (empty)
- Owner: root

Select the remote site for the relevant connection. As Condition select 'Broken' and enter the action as the transmission of an e-mail.

```
mailto:admin@mycompany.com?subject=VPN connection broken at %t?body=VPN connection to Subsidiary 1 was broken.
```

If the connection is broken, this action sends an e-mail to the administrator with the time of the event in the subject line.

- ! If the mail is sent to an appropriate Mail2SMS gateway the alert can be sent directly to a mobile telephone.
- ! For complex scenarios with several subsidiaries, each of the remote sites is given a corresponding entry in the central LANCOM. For monitoring the central device itself, an action is entered into a device at one of the subsidiaries. In this way the administrator receives an alert even if the VPN gateway at the central location fails, which could potentially prevent any messages from being transmitted.

#### 4.4.2 Suppress messaging in case of re-connects with a DSL connection

Some providers interrupt the DSL connection used for the VPN connections once every 24 hours. To avoid informing the administrator of these regular interruptions, messaging can be disabled at the time when the re-connect occurs.

First of all an action is required to force the re-connect to occur at a fixed time; generally at night when the Internet connection is not in use. The entry defines, for example, 03:00h and the Internet connection is broken with the command `do other/manual/disconnect internet`.

With two more cron commands `set /setup/wan/action-table/1 yes/no` the corresponding entry in the action table is switched off three minutes before 03:00h and switched on again three minutes after 03:00h. The number 1 following the path to the action table is an index that stands for the first entry in the table.

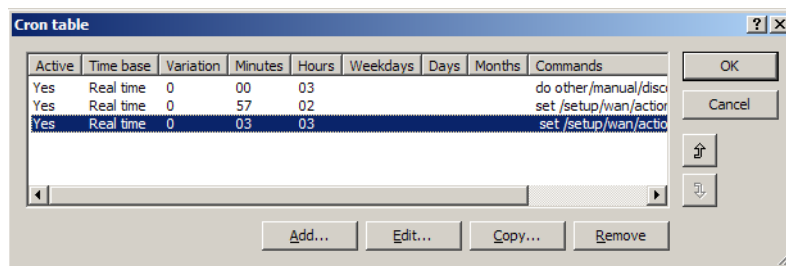

#### 4.4.3 Addition(s) to LCOS 7.70

##### Sending attachments with the mailto command

E-mails with information on device status can be sent automatically if certain events occur. To do this, just include the mailto command into entries in the action table or cron table.

Attachments can be sent with the e-mails. This allows the results of console commands executed on the device before sending the mail to be sent as an attachment. In this way, the content of tables or menus (e.g. detailed status messages) can be sent by e-mail.

- Action (action table) or command (cron table) (max. 250 characters)

Here you describe the action that is to be executed at a certain time or when a change in the status of the WAN connection occurs. Only one action can be triggered per entry.

Possible values for the actions (max. 250 characters):

- mailto: – This prefix causes an e-mail to be sent.

Optional variables for the actions:

- attach=`console command`

Any console command can be entered which outputs useful information. The console command is enclosed in "backquotes" also known as backticks. This character is produced with the aid of the "accent grave" key.

The output of the console command is written to a text file for attachment to the mail. This text file is headed by the command and a time/date stamp, followed by the output.

Default:

- Blank

Examples:

The following action enables you to send the ADSL status by e-mail:

```
mailto:admin@mycompany.com?subject=ADSL_status?attach=`dir /status/adsl`.
```

An action can be used to send multiple console commands:

```
mailto:admin@mycompany.com?subject=Status_reports?attach=`dir /status/adsl`?attach=`dir /status/config`
```

The attached files are named 'cmd1.txt', 'cmd2.txt', etc.

## 4.5 Managing rights for different administrators

New in LCOS 7.60:

- Administrators without trace rights

Multiple administrators can be set up in the configuration of the LANCOM, each with different access rights. Up to 16 different administrators can be set up in a LANCOM.

 Along with the administrators set up in the configuration, there is also the "root" administrator with the main password for the device. This administrator always has full rights and cannot be deleted or renamed. To log in as root administrator, enter the user name "root" in the login window or leave this field empty.

As soon as a password is set for the "root" administrator in the device's configuration, then WEBconfig will display the button **Login** that starts the login window. After entering the correct user name and password, the main menu of the WEBconfig will appear. This menu only displays the options that are available to the administrator who is currently logged in.

If more than one administrator is set up in the admin table, the main menu features an additional button **Change administrator**, which makes it possible to switch to a different user ID (with different rights, if applicable).

### 4.5.1 Rights for the administrators

Two different groups are differentiated regarding administrators' rights.

- Each administrator belongs to a certain group that has globally defined rights assigned to it.
- Each administrator also has "function rights" that determine personal access to certain functions such as the Setup Wizards.

#### Administrator groups

Description under Telnet/Terminal	Description under LANconfig	Rights
Supervisor	All	Supervisor - member of all groups
Admin-RW	Limited	Local administrator with read and write access
Admin-RW limit	Limited without trace rights	Local administrator with read and write access but without trace rights
Admin-RO	Read only	Local administrator with read access but no write access
Admin-RO limit	Read only without trace rights	Local administrator with read access but no write access and no trace rights
None	None	No access to the configuration

- Supervisor: Has full access to the configuration

- Local administrator with read and write access: Also has full access to the configuration, although the following options are prohibited:
  - Upload firmware onto the device
  - Upload configuration onto the device
  - Configuration with LANconfig



Local administrators with write access can also edit the admin table. However, a local administrator can only change or create entries for users with the same or fewer rights than himself. It follows that a local administrator cannot create a supervisor access and assign himself those rights.

- Local administrator with read and write rights but without trace rights: Also has full access to the configuration, although the following options are prohibited:
  - Upload firmware onto the device
  - Upload configuration onto the device
  - Configuration with LANconfig
  - Trace output via Telnet or LANmonitor



Local administrators with write access but without trace rights cannot create administrators with trace rights.

- Local administrator with read access: Can read the configuration with Telnet or a terminal program, but cannot change any values. The administrators can be assigned certain configuration options via their function rights.
- None: Cannot read the configuration. The administrators can be assigned certain configuration options via their function rights.

### Function rights

Function rights can be used to grant the following options to users:

- Basic Settings Wizard
- Security Settings Wizard
- Internet Connection Wizard
- Selection of Internet Provider Wizard
- RAS Account Wizard
- LAN-LAN Connection Wizard
- Change time and date
- Search for further devices
- WLAN link test
- a/b Wizard

## 4.5.2 Administrators' access via TFTP and SNMP

The additional access possibilities for administrators are generally used for configuring the device with Telnet, terminal programs or SSH access. However, the other administrators can also access the device via TFTP or SNMP.

### Access with LANconfig

A user with supervisor rights can login to LANconfig by entering his user data into the Password field of the login window in the combination <User name>:<Password>.

### Access with TFTP

In TFTP, the user name and password are coded in the source (TFTP read request) or target file names (TFTP write request). The file name is either made up of the master password and the command to be executed, or of the combined user name and password separated by a colon, plus with the command as a suffix. A command sent by TFTP therefore resembles the following:

- <Master password><Command> or
- <User name>:<Password>@<Command>

Examples (the LANCOM has the address mylancom.intern, the master password is 'RootPwd' and a user has been set up named 'LocalAdmin' with the password 'Admin'):

- Read the configuration from the device (supervisor only)

```
tftp mylancom.intern GET RootPwreadconfig mylancom.lcf
```

- Write the configuration to the device (supervisor only)

```
tftp mylancom.intern PUT mylancom.lcf RootPwwriteconfig
```

- Read out the device MIB (for the local administrator)

```
tftp mylancom.intern GET localadmin:Admin@readmib mylancom.mib
```

For the menus and available commands, the same limitations on rights apply as with Telnet.

### Access with SNMP management systems

For the administration of networks with the help of SNMP tools such as HP OpenView, the various levels of administrator access can be used for the precise control of rights.

Under SNMP, user name and password are coded in the "community". Here, the 'public' community can be selected or one of either the master password or a combination of user name and password divided by a colon can be selected.

- ! The community 'public' corresponds with the rights of a local administrator with read-only access, as long as the SNMP read access without password is enabled. If this access is not allowed, then the 'public' community will have access to no menus at all.

Otherwise, the same limitations on rights apply for the menus as with Telnet.

## 4.5.3 Configuration of user rights

When using LANconfig for the configuration, you will find the list of administrators in the configuration area 'Management' on the 'Admin' tab under the button **Further administrators**.

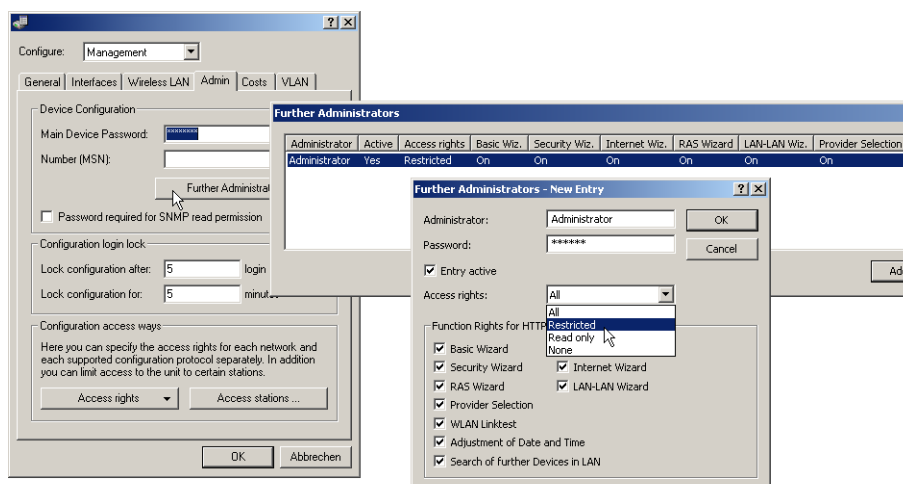

Enter the following values:

- Name for the new administrator with password.
- Access rights

- Function rights

 You can temporarily deactivate the entries without having to delete them completely with the button 'Entry active'.

Under WEBconfig, Telnet or a terminal program, you will find the admin table under the following paths:

WEBconfig: LCOS menu tree / Setup / Config-module / Admin.-table

The different user groups are represented by the following values:

Description	Rights
Supervisor	Supervisor - member of all groups
Admin-RW	Local administrator with read and write access
Admin-RW limit	Local administrator with read and write access but without trace rights
Admin-RO	Local administrator with read access but no write access
Admin-RO limit	Local administrator with read access but no write access, without trace rights
None	No access to the configuration

The different function rights are represented by the following hexadecimal values:

Value	Rights
0x00000001	The user can run the Basic Settings Wizard
0x00000002	The user can run the Security Wizard
0x00000004	The user can run the Internet Wizard
0x00000008	The user can run the Wizard for selecting Internet providers
0x00000010	The user can run the RAS Wizard
0x00000020	The user can run the LAN-LAN Coupling Wizard
0x00000040	The user can set the date and time (also applies for Telnet and TFTP)
0x00000080	The user can search for additional devices
0x00000100	The user can run the WLAN Link test (also applies for Telnet)
0x00000200	The user can run the a/b Wizard
0x00000400	The user can run the WTP Assignment Wizard
0x00000800	The user can run the Public Spot Wizard
0x00001000	The user can run the WLAN Wizard
0x00002000	The user can run the Rollout Wizard
0x00004000	The user can run the Dynamic DNS Wizard
0x00008000	The user can run the VoIP Call Manager Wizard
0x00010000	The user can run the WLC Profile Wizard

The entry results from the sum of the first, second and third columns from the right. If, for example, the user is to receive rights to use the "Security Wizard", "Selection of Internet provider", "RAS Wizard", "Change time" and "WLAN Link Test", then the resulting values are as follows:

- First column from the right: 2 (Security Wizard) + 8 (Selection of Internet Provider) = "a" (hexadecimal)
- Second column from the right: 1 (RAS Wizard) + 4 (Change Time) = "5" (hexadecimal)
- Third column from the right: 1 (WLAN-Linktest) = "1" (hexadecimal)

For this example, enter the the function rights as "0000015a".



Put differently, this is an OR operator with the following hexadecimal values:

Description	Value
Security Settings Wizard	0x00000002
Selecting the provider	0x00000008
RAS Account Wizard	0x00000010
Changing the time	0x00000040
WLAN link test	0x00000100
OR operated	0x0000015a

### Examples:

The following command sets up a new user in the table who, as local administrator "Smith" with the password "BW46zG29", can select the Internet provider. The user will be activated immediately:

```
set Smith BW46zG29 yes Admin-RW 00000008
```

The following command extends the function rights such that user "Smith" can also run the WLAN link test (the asterisks stand for the values which are not to be changed):

```
set Smith * * * 00000108
```

## 4.5.4 Limitation of the configuration commands

The availability of commands when configuring the devices with Telnet or a terminal program depends on the user's rights:

Command	Supervisor	Local administrator	Remark
activateimage	4		
cfgreset	4		
linktest	4		The 'linktest' command can also be executed if the user possesses the function right to carry out a WLAN link test
readconfig	4		
writeconfig	4		
writeflash	4		
setenv	4	4	
testmail	4	4	
time	4	4	The 'time' command can also be executed if the user possesses the function right to set the system time
unsetenv	4	4	
delete/rm	4	4	
readmib	4	4	
WLA	4	4	
set	4	4	

All other commands (such as 'cd', 'ls', 'trace', etc...) can be used by all users. The user must possess at least write access to be able to operate commands that cause changes to the system (e.g. 'do' or 'time').

! The commands listed above are not available in all LCOS versions nor LANCOM models.

## 4.5.5 TCP port tunnel

In some cases it can be useful to enable temporary remote access to a station within a LAN, e.g. via HTTP (TCP port 80) or TELNET (TCP port 23). For example, if questions come up concerning network devices such as a LANCOM VP-100, the Support department is best able to assist with direct access to the device in the customer's LAN. The standard method for accessing LAN devices via inverse masquerading (port forwarding) sometimes requires a special configuration of the firewall—changes are made which, if they are not deleted again afterwards, can represent a security risk.

As an alternative to permanent access which is based on port forwarding, a temporary remote-maintenance access can be set up that automatically closes again after certain periods of inactivity. To this end, a support staff member requiring access to a device in the customer's network, for example, creates a "TCP/HTTP" tunnel using TCP port 80 to provide this access.

! This access only applies to the IP address that was the source of the tunnel. Network access to devices released in this way is not transferable!

### Configuring the TCP/HTTP tunnel

The following parameters are available for configuring TCP/HTTP tunnel in LANCOM:

WEBconfig: LCOS menu tree / Setup / HTTP

- Max. tunnel connections

The maximum number of simultaneously active TCP/HTTP tunnels

- Tunnel idle timeout

Life-expectancy of an inactive tunnel. After expiry of this time period the tunnel closes automatically unless data transfer is actively taking place.

### Create the TCP/HTTP tunnel

1. HTTP tunnels are set up on the start page of WEBconfig. In WEBconfig log on to the LANCOM Wireless behind which the device to be released is located. If necessary obtain the required login data from the responsible administrator.
2. In the area 'Extras', select the entry **Create TCP/HTTP tunnel**

The screenshot shows the LANCOM WEBconfig interface. On the left is a navigation menu with the following items: Setup Wizards, System information, Configuration, LCOS Menu Tree, File management, Extras, Search, Get Device SNMP MIB, Show/Search Other Devices, Display Key Fingerprints, Edit List of Allowed SSH Public Keys, Create TCP/HTTP Tunnel, Enable Software Option, Set Date and Time, Change password, Reboot, HTTP-Session, and Logout. The 'Extras' menu is expanded, showing a list of options: Search, Get Device SNMP MIB, Show/Search Other Devices, Display Key Fingerprints, Edit List of Allowed SSH Public Keys, Create TCP/HTTP Tunnel, Enable Software Option, Set Date and Time, Change password, and Reboot. The main content area shows the 'Logout' page with the LANCOM logo and the text 'Please choose the desired menu entry:' followed by the same list of options as the expanded menu.

1. Enter the name or IP address of the device that is to be temporarily available via HTTP.

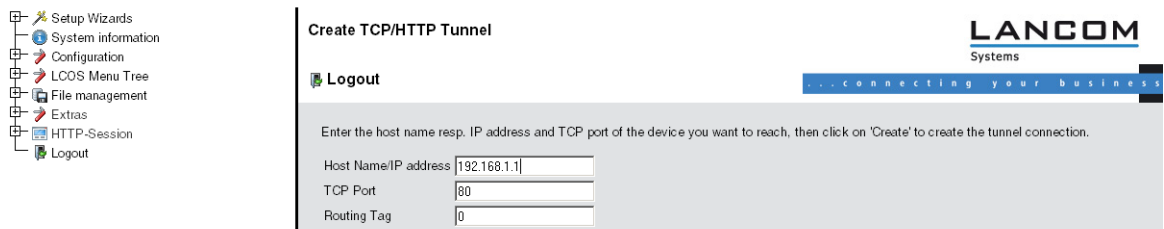

1. Select a port for the HTTP tunnel and, if applicable, enter the routing tag of the IP network in which the device is located and confirm your entries with **Create**.
2. The dialog that follows displays a confirmation of the newly created tunnel and provides a link to the device.

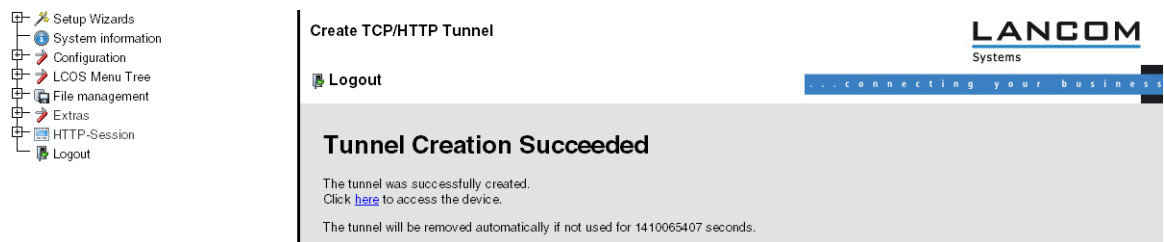

- ⚠ Apart from HTTP or HTTPS-based access, remote maintenance can also be based on any other TCP service such as telnet connections (TCP port 23) or SSH (TCP port 22).

### Deleting the tunnel prematurely

The newly created HTTP tunnel is deleted automatically if the tunnel remains inactive for the duration of the tunnel idle timeout. To delete the tunnel earlier, click on **LCOS menu tree / Status / TCP-IP / HTTP** to access the list of active tunnels and delete the one you no longer require.

- ⚠ Although active TCP connections in this tunnel are **not** terminated immediately, no new connections can be established.

## 4.6 Named loopback addresses

A LANCOM Wireless can be set with up to 16 loopback addresses with which it can be addressed, for example for the management of large network structures. To use the loopback addresses for certain networks (e.g. in the context of Advanced Routing and Forwarding), these addresses can be assigned with routing tags. To simplify the identification in other configuration units, the loopback addresses can be given freely definable names:

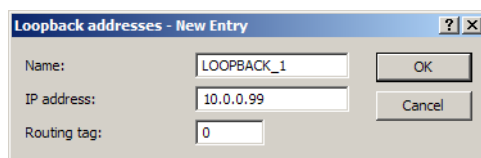

LANconfig: TCP/IP / General / Loopback addresses

WEBconfig: LCOS menu tree > Setup > TCP-IP > Loopback list

- Name

A freely definable name for the loopback address.

- **Loopback address**  
Loopback address for the device.
- **Routing tag**  
Routing tag of the loopback address. Loopback addresses with the routing tag '0' (untagged) are visible to all networks. Loopback addresses with a different routing tag are only visible to networks with the same routing tag.

### 4.6.1 Loopback addresses with ICMP polling

Similar to LCP monitoring, ICMP polling transmits regular requests to a remote site. Ping commands are transmitted and the answers to them are monitored. Unlike LCP monitoring, the target site for ICMP pings can be freely defined. Pinging a router in a remote network thus provides monitoring for the entire connection and not just the section to the Internet provider.

A ping interval is defined for the remote site in the polling table. Further, for the event that replies are missed, the number of retries before the transmission of a new LCP request is defined. Should the transmitter not receive any reply to the retries, the target for the ping requests is classified as unavailable.

Up to four different IP addresses can be entered for each remote site that will be checked in the remote network in parallel. Only if all of the IP addresses are unavailable is the connection considered to have failed.

! With the ICMP polling, an entire connection can be monitored from end to end.

LANconfig: Communication / Remote Sites / Polling table

WEBconfig: LCOS menu tree / Setup / WAN / Polling table

- **Peer**  
Name of the remote station which is to be checked with this entry.
- **IP address 1 - 4**  
IP addresses for targeting with ICMP requests to check the remote site.

! If no IP address is entered for a remote site that can be checked with a ping, then the IP address of the DNS server that was determined during the PPP negotiation will be checked instead.

- **Ping interval**  
The time entered into the polling table defines the time interval between ping requests. If the value "0" is entered, then the standard value of 30 seconds applies.
- **Retries**  
If no reply to a ping is received then the remote site will be checked in shorter intervals. The device then tries to reach the remote site once a second. The number of retries defines how many times these attempts are repeated. If the value "0" is entered, then the standard value of 5 retries applies.
- **Loopback address**

Sender address sent with the ping; this is also the destination for the answering ping.

## 4.6.2 Loopback addresses for time servers

LANCOM Wireless can retrieve time information from public time servers in the Internet (NTP server). The LANCOM can then be provided the time to all stations in the local network. When defining the time server, the name or IP address of the NTP server being queried by the LANCOM Wireless can be entered as well as loopback addresses.

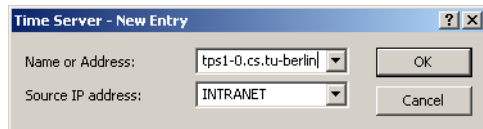

LANconfig: Date & time / Synchronization / Time server

WEBconfig: LCOS Menu Tree / LCOS menu tree / Setup / NTP / RQ address

### ■ Name

Name or IP address of the NTP server. The LANCOM Wireless attempts to reach the servers in the order that they are entered.

### ■ Loopback address

Sender address sent with the NTP request; this is also the destination for the NTP answer.

## 4.6.3 Loopback addresses for SYSLOG clients

The SYSLOG module enables the logging of accesses to the LANCOM Wireless. SYSLOG clients are set up to be able to receive the SYSLOG messages.

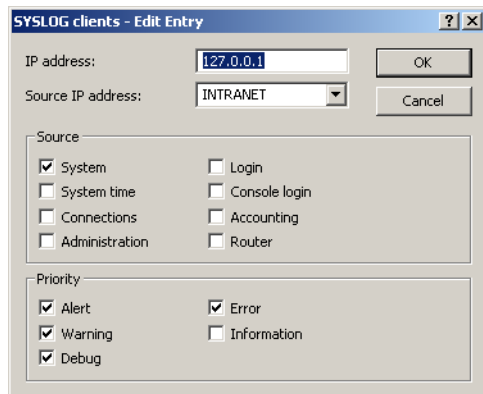

LANconfig: Log & Trace / SYSLOG / SYSLOG clients

WEBconfig: LCOS menu tree / Setup / SYSLOG / SYSLOG table

### ■ IP address

IP address of the SYSLOG client.

### ■ Loopback address

Sender address entered into the SYSLOG message. No answer is expected to a SYSLOG message.

### ■ Source

- System: System messages (boot events, timer system, etc.)
- Logins: Messages concerning the user's login or logout during the PPP negotiation, and any errors that occur during this.
- System time: Messages about changes to the system time

- Console logins: Messages about console logins (Telnet, Outband, etc.), logouts and any errors that occurred during this.
- Connections: Messages about establishment and termination of connections and any errors that occurred (display trace)
- Accounting: Accounting information stored after termination of a connection (user, online time, transfer volumes)
- Administration: Messages on changes to the configuration, remotely executed commands, etc.
- Router: Regular statistics about the most frequently used services (breakdown per port number) and messages about filtered packets, routing errors, etc.
- Priority
  - Alert: This is a collection of messages of interest to the administrator (general SYSLOG priority: PANIC, ALERT, CRIT).
  - Error: At this level all error messages which can occur under normal conditions are communicated; no special attention is required by the administrator, e.g. connection errors (general SYSLOG priority: ERROR).
  - Warning: This level communicates messages which do not compromise normal operating conditions (general SYSLOG priority: WARNING).
  - Information: At this level, all messages are sent that have a purely informational character (e.g. accounting) (general SYSLOG priority: NOTICE, INFORM).
  - Debug: Communication of all debug messages. Debug messages generate large data volumes and can compromise the device's operation. For this reason they should be disabled for normal operations and only used for trouble-shooting (general SYSLOG priority: DEBUG).

## 4.7 Addition(s) to LCOS 8.00

### 4.7.1 Automatic upload of firmware or configuration from external data media

#### Introduction

LANCOM devices with a USB connector can be commissioned very easily with the aid of an external data medium. Firmware files, loaders and even full configurations or scripts can be uploaded into the device from a USB medium.

#### Automatic upload of loader and/or firmware files

With this function activated and a USB medium mounted, the device searches for a loader and/or firmware files in the directory "Firmware". All files in the directory with the file extension ".upx" will be considered for automatic loading if they are for the correct device type. This is done by reading the file headers and processing the files according to the following rules:

- If at least one .upx file with a loader is found, then the loader with the highest version number is loaded, unless the device already contains a loader with a higher version number.
- If at least one firmware file is found, then the firmware with the highest version number is loaded into the device, assuming that its version number is not equal to that of active or inactive firmware versions already in the device.

During the automatic load procedure, the device's power LED and online LED blink alternately. If a loader is uploaded first, the device will restart after this and it will commence a second automatic upload if new firmware is found. During this second load procedure, too, the device's power LED and online LED blink alternately.

The automatic uploading of loaders and/or firmware may, if applicable, be followed by further uploads of configuration files and/or script files.

Once the automatic upload procedure is complete, all LEDs on the device light up in green for 30 seconds. The USB medium can be removed.

## Automatic upload of configuration and/or script files

With this function activated and a USB medium mounted, the device searches for configuration and/or script files in the directory "Config". All files in the directory with the file extension ".lcs" or ".lcf" will be considered for automatic loading if they are for the correct device type. This is done by reading the file headers and processing the files according to the following rules:

- A full configuration ".lcf" is always loaded before a script ".lcs". Full configurations will only be loaded if the device type matches the device doing the loading, and if the firmware version entered into the header is the same as the active firmware in the device. If several suitable full configurations are found, then selection procedure follows these criteria:
  - The configuration header contains a device serial number that matches that of the device doing the upload.
  - The configuration header contains a MAC address that matches that of the device doing the upload.
  - If multiple configuration files are left over after applying these selection criteria, then the configuration with the most recent date is taken.

! The header parameters for configuration files can be set manually in the file dialog of LANconfig when an offline configuration is to be saved.

- If there is no full configuration available, then a script file (".lcs") is used instead, if available. If several suitable scripts are found, then selection procedure follows these criteria:
  - The script header contains a device serial number that matches that of the device doing the upload.
  - The script header contains a MAC address that matches that of the device doing the upload.
  - The script header contains a firmware version that matches that of the device doing the upload.
  - If multiple script files are left over after applying these selection criteria, then the script with the most recent date is taken.

! The header parameters for scripts can be set manually using a text editor in the corresponding script file as "SERIAL:" and/or "MAC:" and if applicable a firmware version.

During the automatic load procedure, the device's power LED and online LED blink alternately.

Once the automatic upload procedure is complete, all LEDs on the device light up in green for 30 seconds. The USB medium can be removed.

## Configuration

The configuration for automatic loading is to be found under the following menu:

- LANconfig: Management / USB-Datenträger

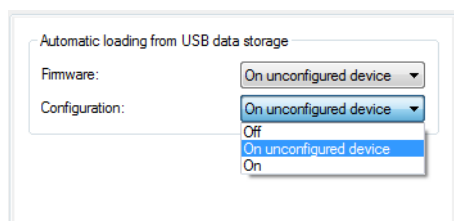

- WEBconfig: LCOS menu tree / Setup / Autoload



- Firmware

This option activates the automatic loading of loader and/or firmware files from a connected USB medium.

Possible values:

- Off

Automatic loading of loader and/or firmware files is deactivated.

- On

Automatic loading of loader and/or firmware files is activated.

When a USB medium is mounted, a suitable loader and/or firmware file is uploaded to the device. The USB medium is mounted when it is plugged into the USB connector on the device, or when it is restarted.

- On unconfigured device

Automatic loading of loader and/or firmware files is only activated when the device has its factory settings. A configuration reset can be used to return the device to its factory settings at any time.

Default:

- On unconfigured device

---

 This option is set to "inactive" in the Security Settings Wizard or the Basic Settings Wizard.

#### ■ Configuration

This option activates the automatic loading of configuration and/or script files from a connected USB medium.

Possible values:

- Off

Automatic loading of configuration and/or script files is deactivated.

- On

Automatic loading of configuration and/or script files is activated.

When a USB medium is mounted, a suitable configuration and/or script file is uploaded to the device. The USB medium is mounted when it is plugged into the USB connector on the device, or when it is restarted.

- On unconfigured device

Automatic loading of configuration and/or script files is only activated when the device has its factory settings. A configuration reset can be used to return the device to its factory settings at any time.

Default:

- On unconfigured device

---

 This option is set to "inactive" in the Security Settings Wizard or the Basic Settings Wizard.

 If a user wants to avoid that an undesirable configuration is loaded to the device due to plugging an USB medium an resetting the device to factory default, then the reset button has to be de-activated.

### Meta data for configuration files

For the automatic loading from a USB data storage the configuration files can be marked with the serial number and/or MAC address of a device. The devices will load only a configuration using the auto load function if the loading device's serial number or MAC address match the values from the configuration file.



LANconfig offers a feature to enter these information as meta data when saving a configuration file using the **Meta Parameter** button:

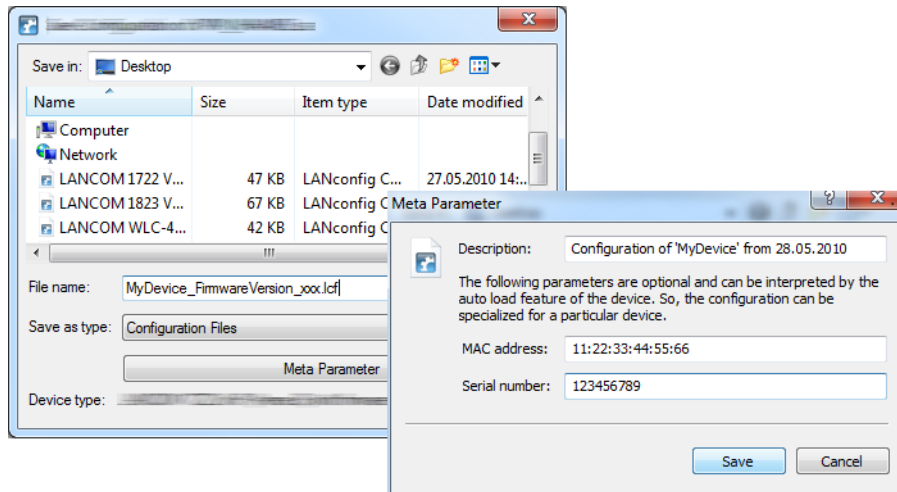

## 4.7.2 Alternative boot config

### Introduction

The way that a LANCOM device operates is determined by its configuration. The configuration is defined by the user and stored to a special portion of the flash memory that remains intact even when the device is restarted (configuration memory). When shipped, the configuration memory is empty because it does not yet have a user-defined configuration. Once in operation, the configuration memory can be deleted again by carrying out a configuration reset. If a device with an empty configuration memory is restarted or rebooted, the parameter values are taken from a boot configuration containing default values for the respective model.

A configuration is only written to the configuration memory if at least one parameter has been changed. The full configuration is written to the configuration memory. Even if only the device name is changed, current values for all of the parameters available to the device are stored to the user-defined configuration. Values for unchanged parameters are taken from a boot configuration.

LANCOM devices can make use of three different boot configurations:

- LANCOM factory settings: These are the default values for the model as shipped, i.e. the LANCOM standard. The standard boot configuration is contained in the device's firmware.
- Customer-specific standard settings: These are the customer's own standard settings for the model in question. These are used when the configuration memory is empty but the LANCOM default settings should not be used. This function provides LANCOM devices with persistent settings (i.e. remaining available however many times the device is rebooted or reset) that contain customer-specific standard settings for the boot procedure. Customer-specific standard settings are **not** deleted by a configuration reset. Customer-specific standard settings are stored to the first boot memory space.
- Rollout configuration: This configuration is useful for large-scale rollout scenarios where multiple devices need a boot configuration that differs from the LANCOM default configuration. The rollout configuration is activated by pressing the reset key for a particular length of time. The specialized rollout configuration is stored to the second boot memory space.

### Using the boot configuration

When started normally, the LANCOM devices try to use the available configurations in a set order:

- User-defined configuration (in the configuration memory)
- Customer-specific standard settings (in the first boot memory space)
- LANCOM factory settings (in firmware)

The customer-specific standard settings are taken automatically and in preference to the LANCOM factory settings, assuming that the configuration memory is empty.

The rollout configuration is activated with the reset button. The reset button fulfills various functions depending upon how long the button is pressed:

- Less than 5 seconds: Boot (restart), whereby the user-defined configuration is loaded from the configuration memory. If the user-defined configuration is empty, then the customer-specific standard settings (first memory space) are loaded instead. The loading of the customer-specific standard settings is visible when all LEDs on the device light up briefly in red. Similarly, the LANCOM factory settings are loaded if the first memory space is empty.
- Longer than 5 seconds until the **first** time that all device LEDs light up: Configuration reset (deletes the configuration memory) followed by a restart. In this case the customer-specific standard settings (first memory space) are loaded instead. The loading of the customer-specific standard settings is visible when all LEDs on the device light up briefly in red. The LANCOM factory settings are loaded if the first memory space is empty.
- Longer than 15 seconds until the **second** time that all device LEDs light up: Activating the rollout configuration and deleting the user-defined configuration. After restarting, the rollout configuration is started from the second memory space. The loading of the rollout configuration is visible when all LEDs on the device light up twice briefly in red. The LANCOM factory settings are loaded if the second memory space is empty.

The rollout configuration is activated directly after restarting if the reset button is pressed for more than 15 seconds. The next time the device is restarted, the normal boot sequence applies again automatically (user-defined configuration, customer-specific standard settings, LANCOM factory settings).

 If the reset button has been deactivated in the configuration (set to 'Ignore' or 'Boot only'), it is impossible to load the rollout configuration.

The following diagram illustrates which configuration is loaded by the different reset procedures, depending on the status of the device. Examples:

- If the button is pressed for less than 5 seconds, the user-defined configuration is loaded. If this is not available, then the customer-specific standard settings are loaded. If this is not available then the LANCOM factory settings are loaded.
- If the reset button is pressed for more than 15 seconds then the user-defined configuration is loaded. If this is not available then the rollout configuration is loaded. If this is not available then the LANCOM factory settings are loaded.

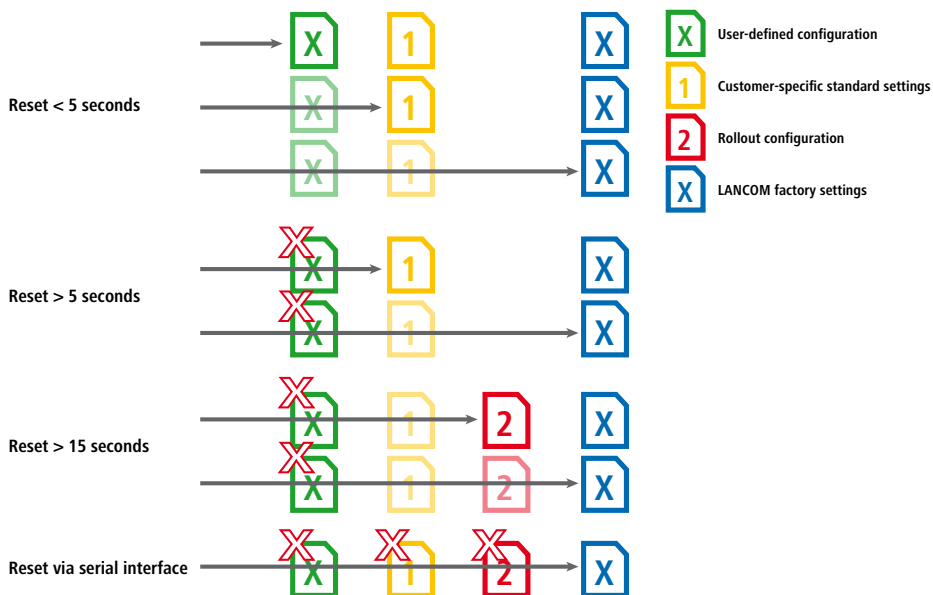

## Restoring the LANCOM factory settings via the serial port

If both memory spaces are taken up with customer-specific standard settings **and** a rollout configuration, then the device cannot be reset to the LANCOM factory settings by using the reset button. If it becomes impossible to access the configuration (e.g. in case of a lost password), then the LANCOM factory settings can only be restored by means of the serial interface.

The serial interface can be used to load firmware into the device. Entering the serial number instead of the configuration password results in the device configuration being reset to its ex-factory settings. In this way you can regain access to the device if it becomes impossible to restore the LANCOM factory settings in any other way.

1. Use the serial configuration cable to connect the device to a computer.
2. On the computer, start a terminal program such as Hyperterminal.
3. Open a connection with the settings 115200bps, 8n1, hardware handshake (RTS/CTS).
4. In the terminal program's welcome screen, press the Return key until the request to enter the password appears.
5. Enter the serial number that is displayed under the firmware version and press Return again.

```

FirmwareUpload - HyperTerminal
File Edit View Call Transfer Help
Outband-115200 Bit/s OK
#
| LANCOM L-54ag Wireless
| Ver. 7.26.0002 / 19.09.2007
| SN. 013020600159
| Copyright (c) LANCOM Systems
Connection No.: 001 (Outband-115200 Bps)
Password:
System is going down ...
@W@
▪ FLASHROM-Upload
| LANCOM L-54ag Wireless
| Copyright (C) LANCOM Systems
| Ver. 2.06.0001 / 22112006 / 16:30
Start Xmodem Upload
$_
Connected 0:01:41 Auto detect 115200 8-N-1 SCROLL CAPS NUM Capture Print echo

```

1. The device now expects a firmware upload. You initiate this in Hyperterminal by clicking on **Transfer/ Send file** and selecting X-Modem as the transfer protocol.

 Uploading the firmware in this way completely deletes the configuration, including the boot configuration, and returns the device to its ex-factory settings! This deletes all of the files stored on the device, including any rollout certificates. For this reason you should only use this option if you have no other way of accessing the device. The configuration and boot configuration are deleted even if the firmware upload is interrupted.

## Storing and uploading the boot configurations

The customer-specific standard settings and the rollout configuration are saved in a compressed format. By means of the command line function, the current device configuration can be saved as customer-specific standard settings or as a rollout configuration. Use the following command for this:

1. `bootconfig -savecurrent [1,2, all] or bootconfig -s [1,2, all]`

Entering the appropriate number ensures that either the first boot memory space for the customer-specific standard settings is selected, or the second boot memory space for the rollout configuration. The parameter "all" writes the current configuration to both memory spaces at the same time.

WEBconfig can also be used to upload customer-specific settings or the rollout configuration into the device:

- WEBconfig: LCOS menu tree / File management / Upload configuration

Here you select the configuration file to be used and you activate the purpose as either customer-specific standard settings and/or rollout configuration.

**!** If both memory spaces are taken up with customer-specific standard settings **and** a rollout configuration, then the device cannot be reset to the LANCOM factory settings by using the reset button. In this case you should use the function.

## Deleting the boot configuration

The alternative and the special boot configurations cannot be deleted with the normal file functions. Use the following command for this:

```
1. bootconfig -remove [1,2, all] or bootconfig -r [1,2, all]
```

Selecting the appropriate number ensures that the corresponding boot memory space is selected. The parameter "all" causes both memory spaces to be deleted at once.

## Working with certificates

In order for VPN and SSL/TLS to function after a configuration reset, a standard certificate can be stored to the device as a PKCS#12 container. This standard certificate is only used by the customer-specific standard settings and the rollout configuration.

- If the customer-specific standard settings are loaded, the standard certificate is copied to the normal certificate storage location for VPN and SSL/TLS. This ensures that it remains available even after rebooting.
- If the rollout configuration is loaded, the standard certificate for VPN is used, but it is not copied. This means that in case of a restart (even without a configuration reset) the device has no access to the certificate.

You can upload the standard certificate into the device with WEBconfig.

- WEBconfig: LCOS menu tree / File management / Upload certificate or file

Select the certificate and commence the upload with **Start upload**.

## 4.8 Addition(s) to LCOS 8.50

### 4.8.1 The commands LoadFirmware, LoadConfig, LoadScript and LoadFile

Various applications, such as loading configurations, firmware versions, scripts, and verifying server identity with certificates, require files to be stored to a device. You can upload these files to a device with LANconfig or WEBconfig. Alternatively, you can use Telnet or SSH to issue a command from the command line to download the files directly from a server (TFTP, HTTP or HTTPS) and into the device. This process simplifies device administration in larger installations that rely on regular updates to the firmware and/or configurations.

The following commands are used to upload different file types to the device:

- LoadConfig: Uploads a configuration file (with file extension \*.lcf) into the device.
- LoadFirmware: Uploads a firmware file (with file extension \*.upx) into the device.
- LoadScript: Uploads a script (file extension \*.lcs) to the device, e.g. for partial configurations.
- LoadFile: Uploads various types of file to the device.

The following descriptions use 'LoadCommand' to describe the upload commands in general.

The upload commands can use the protocols TFTP, HTTP and HTTPS to upload the selected file. A TFTP server is identical to an FTP server in terms of functionality, but uses a different protocol for data transmission. When using an HTTPS server, a certificate used to check the identity of the server can be stored on the device.

---

 The LoadFile command in LCOS version 8.50 supports the protocols HTTP and HTTPS only.

The load commands are invoked from the command line interface with the following syntax:

```
LoadCommand <parameters>
```

The parameters are used to control the behavior of the commands. The parameters can be used in any combination. The only requirement is for a URL to be specified.

Values for condition, URL, or minimum version entered at the command line overwrite (once only) the values set under /Setup/Autoload/Network. Conversely, the values defined in the setup act to supplement the command-line commands if no parameters are entered manually.

General parameters for the load commands:

- -a: This parameter defines the sender address that the device sends to the server when downloading a file. Enter the sender address in one of the following forms:
  - Any valid IP address
  - INT for the address of the first intranet
  - DMZ for the address of the first DMZ
  - LB0 to LBF for the 16 loopback addresses

---

 If the list of IP networks or loopback addresses contains an entry named 'DMZ' then the associated IP address will be used.

- <URL>: This parameter specifies the the URL for downloading a file from a TFTP or HTTP(S) server. Enter the URL in the following form:

```
LoadCommand protocol://Server/Directory/Filename.ext
```

For password-protected file access, enter the data in the following form:

```
LoadCommand protocol://username:password@Server/Directory/Filename.ext
```

- -s: When downloading a file from a TFTP server, this parameter specifies its DNS name or IP address. Use this syntax as an alternative to specifying a URL.

- -f: When downloading a file from a TFTP server, this parameter specifies the name of the required file. Use this syntax as an alternative to specifying a URL.

If the parameters <URL> or -s and -f are not specified, the device executes the commands LoadFirmware, LoadConfig or LoadScript with the default values for the URL as defined under /Setup/Autoload/:

Use these default values if the latest configurations, scripts and firmware versions are always stored under the same name in the same location. If this is the case, the commands LoadConfig, LoadFirmware and LoadScript can be used very easily to load the relevant files automatically.

The following parameters are of particular importance for automatic uploading:

-Cn: This parameter checks if the file referenced by the LoadFirmware command is **newer** than the firmware on the device.

- -Cd: This parameter checks if the file referenced by the LoadFirmware, LoadConfig or LoadScript command is **different** to the firmware or configuration on the device, or newer than the last executed script. When the LoadScript command is used, this parameter updates the checksum stored in the device for the most recently executed script.
- -u: This parameter disables the version checking. The file referenced by the LoadFirmware, LoadConfig or LoadScript command is uploaded and executed unconditionally. When the LoadScript command is used, this parameter does not change the checksum stored in the device for the most recently executed script.
- -m: This value defines the minimum version of the firmware. The firmware referenced by the command must be at least of this version in order for the command LoadFirmware to execute.

---

 The default setting for the conditions under /Setup/Autoload/Network are "Unconditionally". In the default setting, **no** version checking is carried out when the commands LoadFirmware and LoadConfig upload firmware, or when LoadScript executes a script file.

---

 The parameter -u always has priority over other parameters entered in a command.

---

When transferring files from an HTTPS server to a client device, the network components check the identity of the remote site by using certificates. For the automatic loading from HTTPS servers, additional parameters are available for downloading and subsequently checking the certificates:

- -o <Path/Filename.ext>: This parameter specifies the destination when downloading a file from an HTTP(S) server with the LoadFile command. For example, you can use this option to save a certificate on your device for future identity verification when accessing an HTTPS server.
- -c <Path/Filename.ext>: This parameter specifies the name of the certificate used by the device to check the identity of an HTTPS server when downloading a file.
- -p <Path/Filename.ext>: When downloading a file from an HTTPS server, this parameter specifies the name of the PKCS#12 container. The PKCS#12 container can contain multiple CA certificates, and thus supports the identity checking of HTTPS servers with certificate chains. A PKCS#12 container can additionally contain a device certificate and the corresponding private key, so that it can confirm the identity of the device to the HTTPS server if this server requires authentication by certificate.
- -d: The device uses this passphrase to encrypt an unencrypted PKCS#12 container.
- -n: This parameter disables the server-name check when downloading a file from an HTTPS server using the LoadFile command. If you use the download URL to specify the server as a DNS name (and not as an IP address), then the device additionally communicates the server name when sending its request to the server. If the HTTPS server is a virtual server, then this server can respond with the appropriate certificates for the reported DNS name. Without this parameter, the device checks whether the DNS name in the download URL agrees with the common name of the submitted certificates. The unit will start the download only if this check is successful.

Use one of the two following notations to specify a file in the file system of the device:

- Specify a location in the device's internal file system with the path '/minifs/filename.ext'.
- Specify a location on an external USB data medium with the path '/mountpoint/directory/filename.ext'. The available mount points are listed under '/status/file-system/volumes'.

In file names that include the path, you can use the following general variables:

- %m: The LAN MAC address of the device (hexadecimal, lowercase letters, no separators)
- %s: The device serial number.
- %n: The device name
- %l: The location of the device ('location' – from the configuration)
- %d: The device type

 You can use these variables in the load commands, but you cannot change the values for the variables.

In addition to these general variables, you can also use the following environment variables that relate to the device for more flexibility when executing the load commands. All predefined environment variables begin with two underscores: When entering commands on the command line, the variables are preceded by a dollar sign.

- `__BLDDEVICE`: The sub-project of the device. This environment variable stands for the second part of the value for `PROJECT` if you execute the command `#sysinfo#` from the command line. The sub-project generally consists of a string without spaces and it stands for the hardware model of the current device.
- `__DEVICE`: The type of the device, for example as displayed in LANconfig or on the device type label.
- `__FWBUILD`: The build number of the firmware currently used in the device. The build number is a number
- `__FWVERSION`: The version number of the firmware currently used in the device, in the form 'x.yy'. The firmware version consists of the major release before the dot and the minor release after it.
- `__LDRBUILD`: The build number of the firmware currently operating in the device. The build number is a four-digit number.

 When requested for the loader build number, older loaders return an empty string.

- `__LDRVERSION`: The version number of the loader currently installed in the device, in the form 'x.yy'. The loader version consists of the major release before the dot and the minor release after it.
- `__MACADDRESS`: The type of the device, given as a 12-digit string of hexadecimal values with lowercase letters and no separators.
- `__SERIALNO`: The device serial number.
- `__SYSNAME`: The system name of the device.

 If you have already used a name from the environment variables as a user-defined variable in a section of the configuration, then both the configuration and the commands on the command line work primarily with the values of the user-defined variables.

Use the following commands in the CLI to display or modify the environment variables:

- `printenv`: Displays all environment variables and their current values. If you have set one or more environment variables with the command `setenv`, the output of the command `printenv` shows the user-defined value at the top and the default value below it.
- `echo __device`: Displays the current values of a single environment variable, in this example the value for the variable '`__DEVICE`'.
- `setenv __device MeinWert`: Sets the value of an environment variable to the desired value.
- `unsetenv __device`: Sets the value of an environment variable to the default value.

Examples of load commands:

- With the following Telnet command, the device loads a firmware file named 'LC-1811-5.00.0019.upx' into the device from directory 'LCOS/850' on the TFTP server with IP address '192.168.2.200':

```
LoadFirmware -s 192.168.2.200 -f LCOS/850/LC-1811-5.00.0019.upx
```

- With the following Telnet command, the device loads a script intended for a certain MAC-address (named, for example, '00a0571735da.lcs') from the TFTP server with IP address '192.168.2.200':

```
LoadScript -s 192.168.2.200 -f %m.lcs
```

- With the following Telnet command, the device loads a firmware file named 'LC-1811-5.00.0019.upx' into the device from directory 'download' on the HTTP server 'www.myserver.com'. At the same time the identity of the server is checked with the certificate 'sslroot.crt':

```
LoadFirmware -c sslroot.crt
https://www.myserver.com/download/LC-1811-8.50.0019.upx
```

- With the following Telnet command, the device loads a script intended for the specified serial number and the current firmware. The device reads the values for serial number and firmware from the corresponding environment variables:

```
Loadscript $__SERIALNO-$__FWVERSION.lcs
```

## Example applications

### Regularly updating configuration and firmware

This scenario describes how to regularly update the configuration and the firmware of a device every 24 hours.

#### Requirements:

- The device is currently equipped with firmware version '8.30' and a corresponding configuration.
- The HTTP server contains the new firmware version in the form of a file 'LCOS.upx' and the corresponding configuration in the form of a file 'LCOS.lcs'.

#### Configuration:

1. Specify the path that the 'LoadFirmware' command uses to source the upload if no other parameters are available. For example, enter the following command to load the firmware from an HTTP server:

```
set /setup/Setup/Autoload/Network/Firmware/URL
http://www.mycompany.de/firmware/LCOS.upx
```

2. Set the conditions for loading the firmware such that only firmware that is newer than that in the device is loaded:

```
set /Setup/Autoload/Network/Firmware/Condition if-newer
```

3. Specify the path that the 'LoadConfig' command uses to source the upload if no other parameters are available. For example, enter the following command to load the configuration from an HTTP server:

```
set /setup/Setup/Autoload/Network/Firmware/URL
http://www.mycompany.de/configuration/LCOS.lcf
```

4. Set the conditions for loading the configuration such that only a configuration that is different from that in the device is loaded:

```
set /Setup/Autoload/Network/Config/Condition if-different
```

5. Create a cron job that regularly runs the command 'LoadFirmware' at 23:55h:

```
cd /Setup/Config/Cron-Table
```

```
set 1 * * * 55 23 * * * LoadFirmware
```

6. Create a cron job that regularly runs the command 'LoadConfig' at 23:59h:

```
set 2 * * * 59 23 * * * LoadConfig
```

### Update configuration after first updating firmware

This scenario describes a potential situation within a project whereby a firmware update is to be carried out followed by an update of the configuration by script.

#### Requirements:

- The device is currently equipped with firmware version '8.30' and a corresponding configuration.



- The HTTP server contains the new firmware version in the form of a file 'LCOS-850.upx' and the corresponding configuration in the form of a file '<Serial number>-850.lcs'.

ⓘ In this scenario, the configuration script is only to be applied once the device has been equipped with the appropriate firmware.

#### **Configuration:**

1. Specify the path that the 'LoadFirmware' command uses to source the upload if no other parameters are available. For example, enter the following command to load the firmware from an HTTP server:

```
set /setup/Setup/Autoload/Network/Firmware/URL
http://www.mycompany.de/firmware
```

2. Set the conditions for loading the firmware such that only firmware that is newer than that in the device is loaded:

```
set /Setup/Autoload/Network/Firmware/Condition if-newer
```

3. Specify the path that the 'LoadConfig' command uses to source the upload if no other parameters are available. For example, enter the following command to load the configuration from an HTTP server:

```
set /setup/Setup/Autoload/Network/Firmware/URL
http://www.mycompany.de/configuration
```

4. Set the conditions for loading the configuration such that only a configuration that is different from that in the device is loaded:

```
set /Setup/Autoload/Network/Config/Condition if-different
```

5. Create a cron job that regularly runs the command 'LoadFIRMWARE' every 10 minutes:

```
cd /Setup/Config/Cron-Table
```

```
set 1 * * * 10 * * * * LoadFirmware
```

6. Create a cron job that regularly runs the command 'LoadScript' every 10 minutes:

```
set 2 * * * 10 * * * * LoadScript\ $__SERIALNO-$__FWVERSION.lcs
```

#### **The result:**

With this configuration, the device always initially loads the latest firmware.

If the device executes the command 'LoadScript' after initially uploading the firmware and configuration script from the HTTP server, then the environment variable '\_\_FWVERSION' is set with the value '8.30' at this time. The command `LoadScript\ $__SERIALNO-$__FWVERSION.lcs` does not find a suitable configuration script at this time. The device then executes the command `LoadFirmware LCOS.upx` and after rebooting, the environment variable '\_\_FWVERSION' is set to the value '8.50'. The command `LoadScript\ $__SERIALNO-$__FWVERSION.lcs` then finds a suitable script to update the configuration.

ⓘ In the cron command `Loadscript\ $__SERIALNO-$__FWVERSION.lcs`, the space between the load script command and the environment variables is protected with a backslash. Trying to use the alternative notation of enclosing the entire command in quotation marks will result in an error. LCOS treats environment variables in quotation marks as normal text, so the any variables would be ignored.

## 4.8.2 Enhanced Sysinfo

To determine whether changes have been made to the configuration, and to find the time/date when a change was made, Sysinfo contains additional entries in the field CONFIG\_STATUS.

The devices store the value CONFIG\_STATUS each time a change is made to the configuration (via the command line, via SNMP or by loading a script or complete configurations). The value CONFIG\_STATUS consists of the following components:

- Hash value of the device configuration as a unique identifier of configuration status.

- Timestamp of the last change to the configuration in the format HHMMSSddmmyyyy based on Coordinated Universal Time UTC. The reference to UTC guarantees unique values without being influenced by time zone or daylight-saving settings.
- Counter of configuration changes, sequential.

The field CONFIG\_STATUS contains, along with a value for the configuration status switches and a value for the configuration flash status, the additional components in the form <Hash>.<Date>.<Counter>.

Changes to the configuration can be implemented in the appropriate files or scripts (e.g. with LCMS) or on the devices directly (by command line or WEBconfig). The content of CONFIG\_STATUS is influenced by the method by which configuration changes are made.

**The device configuration hash value**

Hash values are calculated solely by LCOS, the operating system used by the devices. The hash value differs for every state of configuration, and a modified hash value indicates that a device configuration has been changed.

! LCOS stores the calculated hash value to the device during the flash process.

**Timestamp of the last configuration change**

Both LCOS and LCMS can set the timestamp, assuming that they have a valid time.

! If the chosen method of configuration does not have a valid time, the device sets the timestamp to the value '00: 00:00 0000-00-00'.

**Configuration changes counter**

When the devices are shipped, the counter of configuration changes is set to '0'. Every configuration change after this increases the value by 1. The configuration-changes counter allows changes to the current version of the configuration to be determined, even if no valid time of configuration was available and the timestamp is therefore set to '00: 00:00 0000-00-00'.

! A configuration counter that shows '0' after changes have been made to the configuration indicates an error while reading or writing the counter during flashing.

**Displaying CONFIG STATUS**

To display the value for CONFIG\_STATUS, enter the command `sys info` on the command line for the device.

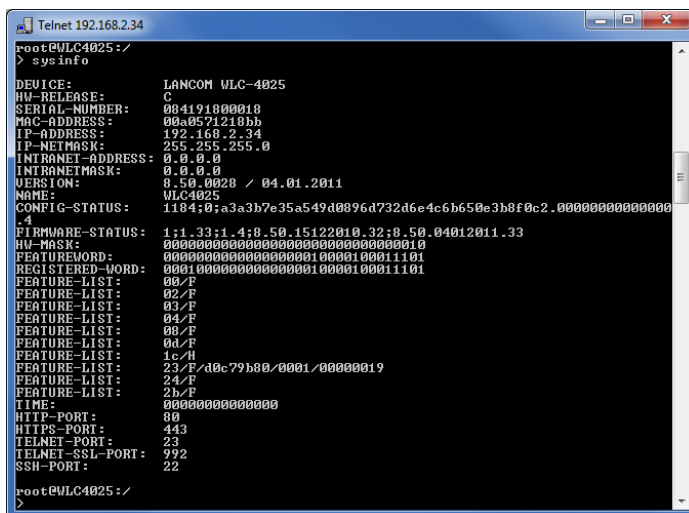

Displaying system information on the command line

## 4.9 Addition(s) to LCOS 8.60

### 4.9.1 Configurable action for alive test

Until now, the alive test only allowed for a cold or warm start in the event of failure. In some cases it may be preferable to execute an action, e.g. to reset a WLAN module. This type of action can significantly reduce the interruption time compared to a cold or warm start.

#### Additions to the menu system

##### Alive test

This menu contains the settings for the alive test. The alive test sends a ping to a destination address at configurable intervals. If there is no response from the destination, the device performs a reboot or other action according to defined criteria.

To configure the alive test you have to define the target address, the action to be performed, the combination of pings and retries, and the threshold for triggering the defined action. The parameters required for this have the following default values:

- Fail limit: 10
- Test interval: 10
- Retry interval: 1
- Retry count: 1

These settings cause the device to transmit a ping every 10 seconds (test interval). If this ping is not answered, the device repeats the ping after 1 second (retry interval) and exactly one time (retry count). If this ping also goes unanswered, the device considers the series to have failed. If 10 series in a row fail (fail limit) then the device triggers the defined action, in this case after  $10 \times 10$  seconds = 100 seconds.

**SNMP ID:** 2.7.21

**Telnet path:** Setup/TCP-IP

##### Action

Enter the action to be performed by the device if the target address is unreachable. You can use the same actions as used in the cron table, i.e. executing CLI commands, HTTP requests, or sending messages.

 The action set here will only be executed if the boot type is set to the value **Action**. The boot type is configured under `/Setup/TCP-IP/Alive-test/Boot-type` (also see [Boot type](#)).

**SNMP ID:** 2.7.21.7

**Telnet path:** /Setup/TCP-IP/Alive-Test

##### Possible values:

- 251 characters

**Default:** Blank

##### Boot type

The device executes this action if the ping to the target address was unsuccessful.

**SNMP ID:** 2.7.21.6

**Telnet path:** /Setup/TCP-IP/Alive-Test

**Possible values:**

- Cold boot: The device performs a cold boot.
- Warm boot: The device performs a warm boot.
- Action: The device performs a configurable action. Configure the action under `/Setup/TCP-IP/Alive-Test` (also see [Action](#)).

**Default:** Warm boot**Fail limit**

This parameter defines the number of consecutive failed test series before the device is rebooted or the configured action is executed.

---

 The product of the error limit and test interval defines the overall duration until rebooting or executing the action.

**SNMP ID:** 2.7.21.5**Telnet path:** `/Setup/TCP-IP/Alive-Test`**Possible values:**

- 0 to 4294967295

**Default:** 10**Test interval**

The time interval in seconds, in which the device sends a ping to the target address. If the ping is unanswered, the device optionally repeats a set number of pings in the defined interval. With this configuration, the device forms a "series" of ping attempts. Only when all pings go unanswered is the complete series evaluated as unsuccessful.

---

 The product of the error limit and test interval defines the overall duration until rebooting or executing the action.

**SNMP ID:** 2.7.21.2**Telnet path:** `/Setup/TCP-IP/Alive-Test`**Possible values:**

- 0 to 4294967295 seconds

---

 Select the test interval as a time which is greater than the product of the retry interval and retry count, so that the desired number of retries can be performed within the test interval.

**Default:** 10**Retry interval**

If a ping goes unanswered, this value defines the time interval before the device repeats the ping to the target address.

**SNMP ID:** 2.7.21.4**Telnet path:** `/Setup/TCP-IP/Alive-Test`**Possible values:**

- 0 to 4294967295

---

 Set the retry interval to a number such that the product of retry interval and retry count is less than the test interval. This ensures that the desired number of retries can be performed within the test interval.

**Default:** 1**Special values:** With a retry interval of 0 the device sends no repeat pings.

**Retry count**

If a ping goes unanswered, this value defines the number of times that the device will repeat the ping to the target address.

**SNMP ID:** 2.7.21.3

**Telnet path:** /Setup/TCP-IP/Alive-Test

**Possible values:**

- 0 to 4294967295



Set the retry count to a number such that the product of retry interval and retry count is less than the test interval. This ensures that the desired number of retries can be performed within the test interval.

**Default:** 1

**Special values:** With a retry count of 0 the device sends no repeat pings.

**Target address**

The target address to which the device sends a ping.

**SNMP ID:** 2.7.21.1

**Telnet path:** /Setup/TCP-IP/Alive-Test

**Possible values:**

- Valid IP address.

## 4.10 Addition(s) to LCOS 8.80

### 4.10.1 SYSLOG accounting is disabled by default

In the SYSLOG server table, you define which system information is sent by the device to the defined SYSLOG server, and with which SYSLOG level. By default, this table includes 8 entries for the destination IP address 127.0.0.1, which represents the internal SYSLOG device memory.

```
root@:/Setup/SYSLOG/Server
> 1
```

Idx.	IP-Address	Source	Level	Loopback-Addr.
0001	127.0.0.1	04	00	INTRANET
0002	127.0.0.1	01	1f	INTRANET
0003	127.0.0.1	10	02	INTRANET
0004	127.0.0.1	40	08	INTRANET
0005	127.0.0.1	02	0a	INTRANET
0006	127.0.0.1	08	08	INTRANET
0007	127.0.0.1	20	00	INTRANET
0008	127.0.0.1	80	01	INTRANET

By default, the device does not send any SYSLOG messages to SYSLOG's internal memory for the sources 04 (clock time) and 20 (accounting).

### 4.10.2 Boot-persistent SYSLOG, event log and boot log

As of LCOS version 8.80, you can save SYSLOG, event log, and boot log messages so that they are available even after rebooting the device (boot persistent).

## Additions to the Setup menu

### Backup interval

This parameter defines the interval in hours for the boot-persistent storage of SYSLOG messages to the flash memory of the device.

**SNMP ID:** 2.22.6

**Telnet path:** /Setup/SYSLOG

**Possible values:**

- 1 to 99

**Default:** 2

### Backup active

Enables the boot-persistent storage of SYSLOG messages to the flash memory of the device.

**SNMP ID:** 2.22.7

**Telnet path:** /Setup/SYSLOG

**Possible values:**

- Yes
- No

**Default:** Yes

### Save bootlog

This parameter enables or disables the boot-persistent storage of SYSLOG messages to the flash memory of the device. Bootlog information is not lost even when restarting after a loss of mains power.

---

 If necessary, you can delete the persistent bootlog memory with the CLI command `deletebootlog`.

**SNMP ID:** 2.11.71

**Telnet path:** Setup/Config

**Possible values:**

- Yes
- No

**Default:** Yes

## Enhancements to command-line commands

### Delete bootlog

The bootlog saves the information about the boot processes of the device. With the parameter *Save-Bootlog* you can optionally enable persistent storage of the bootlogs.

By entering the command `deletebootlog` anywhere on the command line you can delete the contents of the persistent bootlog storage, if necessary.

## Enhancements to LANconfig

### Boot-persistent SYSLOG, event log and boot log

In LANconfig, the settings for the boot-persistent SYSLOG, event log and boot-log messages are to be found under **Log & Trace > System events**.

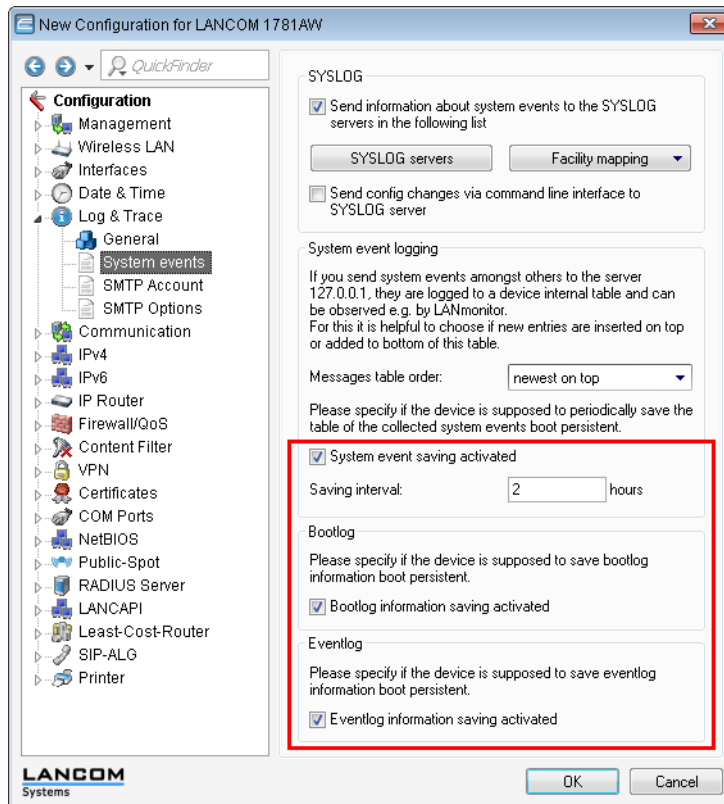

### 4.10.3 SYSLOG: Delete old messages

As of LCOS version 8.80, the devices are able to automatically delete old SYSLOG messages after a defined retention period.

#### Additions to the menu system

##### Max. message age, hours

This parameter defines the maximum period for retaining SYSLOG messages in the internal SYSLOG memory of the device in hours. After this period expires the device automatically deletes the obsolete SYSLOG messages if auto-delete is activated under [Remove old messages](#).

##### SNMP ID:

2.22.9

##### Telnet path:

Setup > SYSLOG

##### Possible values:

1 to 99

**Default:**

24

**Remove old messages**

This parameter enables deletion of the SYSLOG messages in the device after the period set for *Maximum-message-age*.

**SNMP ID:**

2.22.10

**Telnet path:****Setup > SYSLOG****Possible values:**

Yes

No

**Default:**

No

**Enhancements to LANconfig****Automatically delete SYSLOG entries**

In LANconfig, the settings for the automatic deletion of SYSLOG entries are to be found under **Log & Trace > System events**.

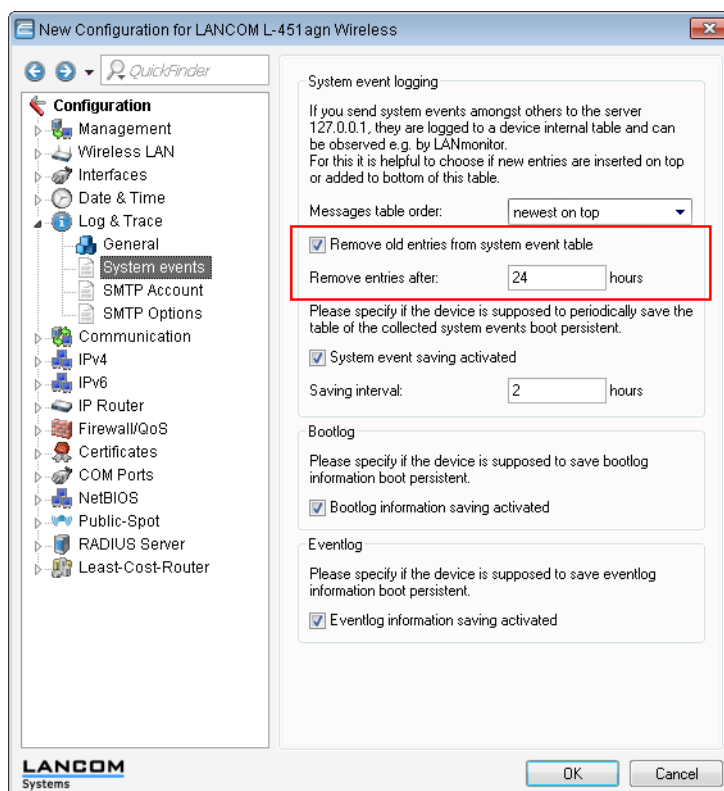

Select the option **Remove old entries from the system event table** to enable automatic deletion.

In the field **Delete entries after:** you set the time, in hours, after which the device is to delete the entries in the table.



## 4.10.4 Logging configuration changes made via the command line

To meet the increased security requirements of network infrastructures, the devices are capable of logging to SYSLOG any changes to the configuration made via the command line interface. Configuration changes include any changes to the configuration parameters, executing actions, and uploading files such as certificates.

The devices write the following information to the SYSLOG:

- User name
- Name of the modified menu item or the executed action
- New value (or a notice that the change was not successful, e. g. due to a lack of permission)

### Additions to the Setup menu

#### Log CLI changes

This parameter enables logging of the commands entered on the command line. Enable this parameter to log an entry in the internal SYSLOG memory when a command is entered on the command line of the device.



This protocol logs commands entered on the command line only. Configuration changes and actions made using LANconfig and WEBconfig are not logged.

**SNMP ID:** 2.22.8

**Telnet path:** /Setup/SYSLOG

**Possible values:**

- Yes
- No

**Default:** No

### Enhancements to LANconfig

#### Sending configuration changes made with the command line to the SYSLOG server

In LANconfig, the settings for logging configuration changes made via the CLI console are to be found under **Log & Trace > System events**.

! This protocol logs commands entered on the command line only. Configuration changes and actions made using LANconfig and WEBconfig are not logged.

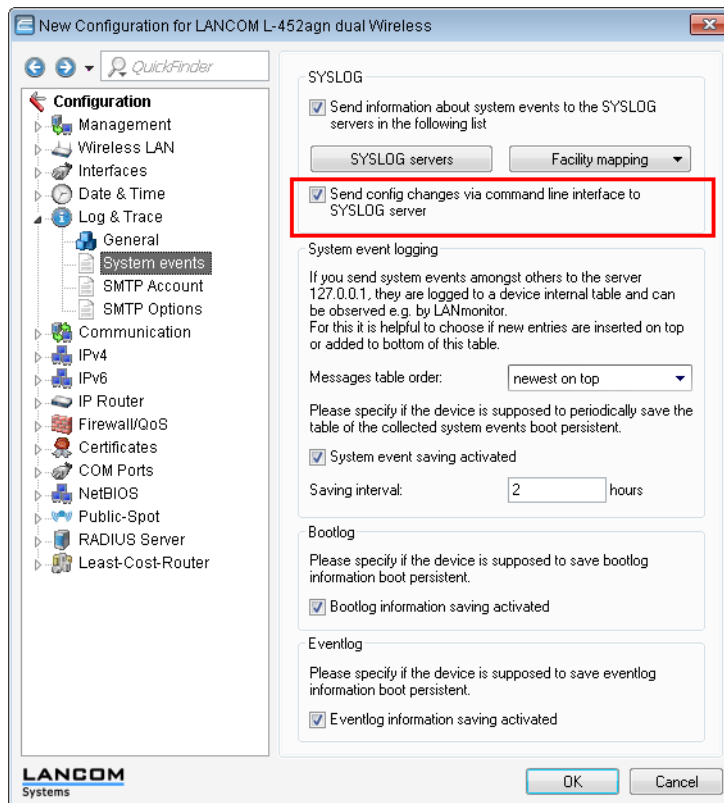

#### 4.10.5 SYSLOG: Change to the default order

As of LCOS version 8.80, the SYSLOG table show the latest messages at the top by default. You can reverse the sorting order if you wish.

#### Additions to the Setup menu

##### Message table order

This item determines the order in which the messages table is displayed.

**SNMP ID:** 2.22.5

**Telnet path:** /Setup/SYSLOG

##### Possible values:

- Oldest on top
- Newest on top

**Default:** Newest-on-top

## Enhancements to LANconfig

### Order of the system events

In LANconfig, the settings for the order in which system events are displayed are to be found under **Log & Trace > System events**.

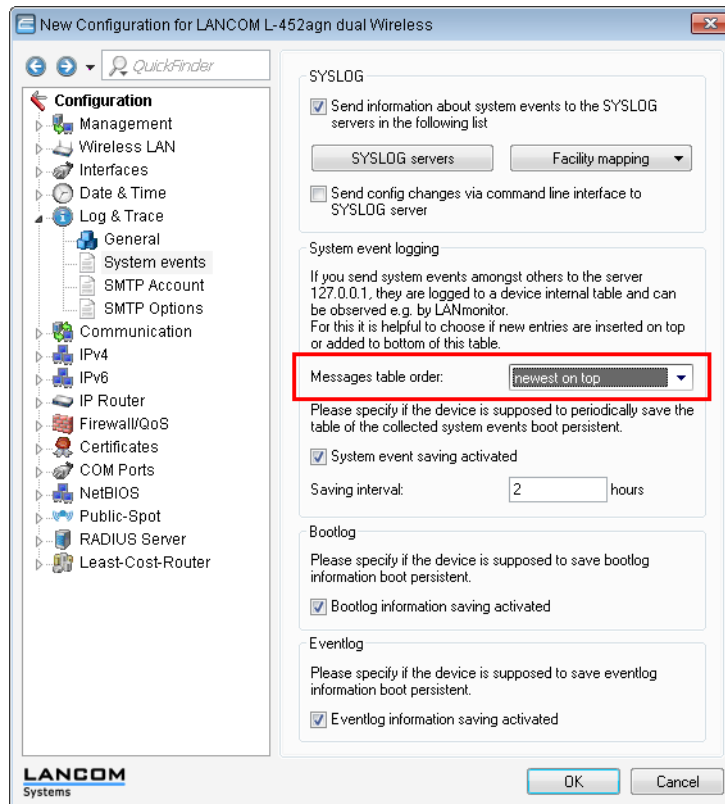

## 5 Diagnosis

### 5.1 Trace information—for advanced users

Trace outputs may be used to monitor the internal processes in the router during or after configuration. One such trace can be used to display the individual steps involved in negotiating the PPP. Experienced users may interpret these outputs to trace any errors occurring in the establishment of a connection. A particular advantage of this is: The errors being tracked may stem from the configuration of your own router or that of the remote site.

 The trace outputs are slightly delayed after the actual event, but are always in the correct sequence. This will not usually hamper interpretation of the displays but should be taken into consideration if making precise analyses.

#### 5.1.1 How to start a trace

Trace output can be started in a Telnet session. Set up a Telnet connection to your device. The command to call up a trace follows this syntax:

```
■ trace [code] [parameters]
```

The trace command, the code, the parameters and the combination commands are all separated from each other by spaces.

#### 5.1.2 Overview of the keys

This code...	... in combination with the trace causes the following:
?	displays a help text
+	switches on a trace output
-	switches off a trace output
#	switches between different trace outputs (toggle)
no code	displays the current status of the trace

#### 5.1.3 Overview of the parameters

 The available traces depend individually on the particular model and can be listed by entering trace with no arguments on the command line.

This parameter...	... brings up the following display for the trace:
Status	status messages for the connection
Error	error messages for the connection
IPX-router	IPX routing
PPP	PPP protocol negotiation
SAP	IPX Service Advertising Protocol
IPX-watchdog	IPX watchdog spoofing
SPX-watchdog	SPX watchdog spoofing

This parameter...	... brings up the following display for the trace:
LCR	Least-Cost Router
Script	script processing
IPX-RIP	IPX Routing Information Protocol
Firewall	Firewall activities
RIP	IP Routing Information Protocol
ARP	Address Resolution Protocol
ICMP	Internet Control Message Protocol
IP masquerading	processes in the masquerading module
DHCP	Dynamic Host Configuration Protocol
NetBIOS	NetBIOS management
DNS	Domain Name Service Protocol
Packet dump	display of the first 64 bytes of a package in hexadecimal form
D-channel-dump	trace on the D channel of the connected ISDN bus
ATM-cell	spoofing at the ATM packet level
ATM-Error	ATM errors
ADSL	ADSL connections status
SMTP-Client	E-mail processing of the integrated mail client
Mail-Client	E-mail processing of the integrated mail client
SNTP	Simple Network Time Protocol information
NTP	Timeserver Trace
Connect	Messages from the activity protocol
Cron	cron table
RADIUS	RADIUS trace
Serial	Status of serial interface
USB	Status of USB interface
Load-Balancer	Load balancing information
VRRP	Information concerning Virtual Router Redundancy Protocol
Ethernet	Status of ethernet interface
VLAN	Information concerning virtual networks
IGMP	Information concerning Internet Group Management Protocol
WLAN	Information concerning wireless networks
IAPP	Trace for Inter Access Point Protocol, shows information concerning WLAN roaming.
DFS	Trace for Dynamic Frequency Selection
Bridge	Information concerning WLAN bridge
EAP	Trace for EAP
Spgtree	Information concerning Spanning Tree Protokoll
LANAUTH	LAN authentication (e.g. Public Spot)
SIP-Packet	SIP information which is exchanged between a LANCOM VoIP Router and a SIP provider or upstream SIP PBX

This parameter...	... brings up the following display for the trace:
VPN-Status	IPSec and IKE negotiation
VPN-Packet	IPSec and IKE packets

### 5.1.4 Combination commands

This combination command...	... brings up the following display for the trace:
All	all trace outputs
Display	status and error outputs
Protocol	LANCOM and PPP outputs
TCP-IP	IP-Rt., IP-RIP, ICMP and ARP outputs
IPX-SPX	IPX-Rt., RIP, SAP, IPX-Wd., SPX-Wd., and NetBIOS outputs
Time	displays the system time in front of the actual trace output
Source	includes a display of the protocol that has initiated the output in front of the trace

Any appended parameters are processed from left to right. This means that it is possible to call a parameter and then restrict it.

### 5.1.5 Trace filters

Some traces, such as the IP router trace or the VPN trace, produce a large number of outputs. The amount of output can become unmanageable. The trace filters allow you to sift out the information that is important to you.

A trace filter is activated by adding the parameter "@" that induces the following filter description. In filter description uses of the following operators:

Operator	Beschreibung
(space)	OR: The filter applies if one of the operator occurs in the trace output
+	AND: The filter applies if the operator occurs in the trace output
-	Not: The filter applies if the operator does not occur in the trace output
"	the output must match the search string exactly

An operator can be entered as any string of characters, such as the name of a remote station, protocols or ports. The trace filter then processes the output according to the operator rules, much like an Internet search engine. Examples of the application of filters can be seen under .

### 5.1.6 Examples of traces

This code...	... in combination with the trace causes the following:
trace	displays all protocols that can generate outputs during the configuration, and the status of each output (ON or OFF)
trace + all	switches on all trace outputs
trace - all	switches off all trace outputs
trace + protocol display	switches on the output for all connection protocols together with the status and error messages
trace + all - icmp	switches on all trace outputs with the exception of the ICMP protocol
trace ppp	displays the status of the PPP
trace # ipx-rt display	toggles between the trace outputs for the IPX router and the display outputs

This code...	... in combination with the trace causes the following:
trace + ip-router @ GEGENSTELLE-A GEGENSTELLE-B	switches on all trace outputs for IP routers related to remote site A or B
trace + ip-router @+GEGENSTELLE-A -ICMP	switches on all trace outputs for IP routers related to remote site A or B that do not use ICMP
trace + ip-router @ GEGENSTELLE-A GEGENSTELLE-B +ICMP	switches on all trace outputs for IP routers related to remote site A or B that use ICMP
trace + ip-router @+TCP +"port: 80"	switches on all trace outputs from the IP router with TCP/IP and port 80. "port: 80" is in quotes so that the space is recognised as a part of the string.

## 5.1.7 Recording traces

Traces can be conveniently recorded under Windows (e.g. as an aid to Support), and we recommend you do this as follows:

Start the program HyperTerminal under **Start / Programs / Accessories / Communications / Hyper Terminal**. Enter a name of your choice when prompted to do so.

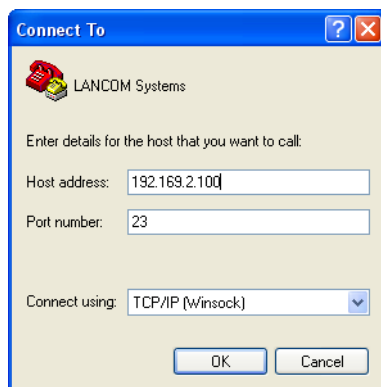

In the window 'Connect to' use the pulldown menu 'Connect using' and select the entry 'TCP/IP'. As 'Host address' enter the local/official IP address or the FQDN of the device. After confirmation, HyperTerminal displays a request to log in. Enter the configuration password .

You record the traces by clicking on **Transmit / Capture text**. Enter the path of the directory where the text file is to be saved. Now change back to the dialog window and enter the required trace command.

To stop the trace, click on the HyperTerminal menu **Transmit / Stop text capture**.

## 5.2 Tracing with LANmonitor

New in LCOS 7.60:

- Saving support files with trace data, device configuration, bootlog and sysinfo
- Automatic backup of trace data
- Trace configuration with Wizards
- Display of show commands
- Display of status information and statistics
- SSL-encrypted Telnet connection

Traces can be executed very easily with LANmonitor. Simply click on the entry for the device with the right-hand mouse key and select **Traces** from the context menu.

- ! Telnet-access to the device must be enabled to carry out trace requests with LANmonitor. When starting the trace dialog, LANmonitor first attempts to establish an SSL-encrypted Telnet connection to the device. If the device does not support SSL connections, LANmonitor automatically switches to unencrypted Telnet. If SNMP access to the device is password-protected, the access data for an administrator with trace rights is also required.

## 5.2.1 Introduction

The trace function in LANmonitor exceeds the standard trace functions available from Telnet and offers greater convenience in the generation and analysis of traces. For example, the current trace configuration for activating the necessary trace commands can be stored to a configuration file. An experienced service technician can set up a trace configuration and provide it to a less experienced user for executing specialized trace requests for a device. The trace results can also be stored in a file and returned to the technician for analysis.

To open the trace window for a device, right-click the device entry in LANmonitor and select "Traces" from the context menu.

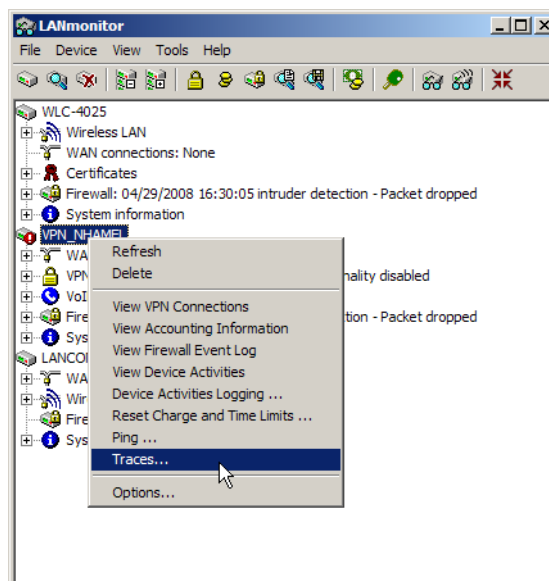

LANmonitor has the following buttons for operating the trace module:

- Opens a pre-defined configuration for the trace command. This allows you to carry out trace commands precisely as required by the service technician, for example.

- Stores the current trace configuration to be passed on to a user.

- Opens a file with trace results for viewing in the trace module.

- Saves the current trace results to a file.

- Clears the current display or trace results.

- Starts outputting the trace results as produced by the current configuration and automatically switches to the trace-result display mode. As soon as the trace results are returned, the other buttons are deactivated.

- Stops the output of trace results.

- Switches to the mode for configuring the trace output.



Switches to the mode for displaying the trace output.

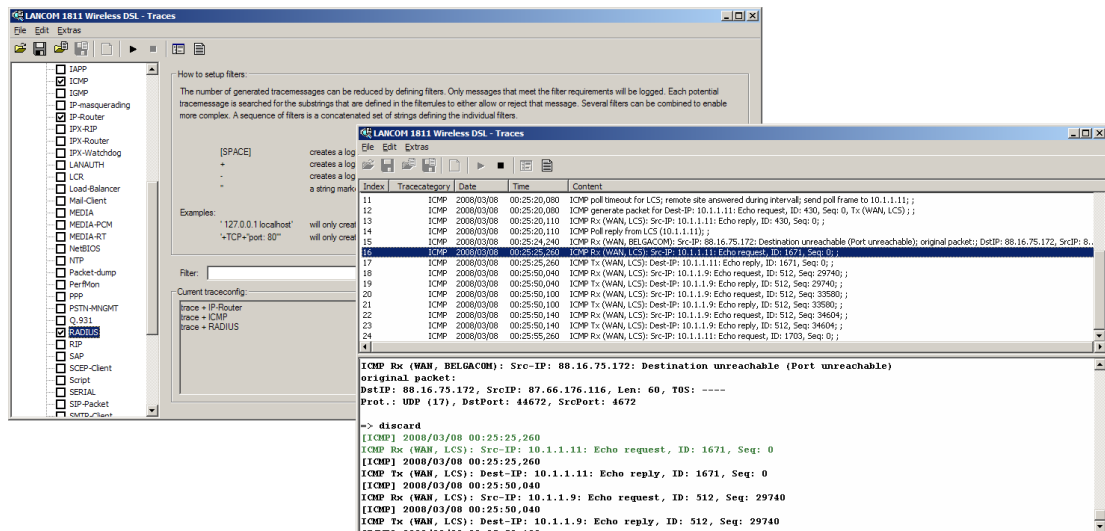

## 5.2.2 Configuring the trace dumps with the Trace Wizard.

The trace settings can be configured very easily with the Wizard. To do this, select **Accompanying Configuration** in the left-hand area of the trace dialog and click **Start Wizard** in the main window. The trace functions can be selected in the following dialogs (such as VPN) and the trace can be further restricted when required (such as to a particular VPN remote site). When ending the Wizard, select whether the Wizard should replace or extend the existing trace configuration.

⚠ With the exception of the bootleg trace (contained automatically), all previous trace settings are deleted when the trace configuration is replaced. Save the previous trace configuration for later use whenever required before running the Wizard.

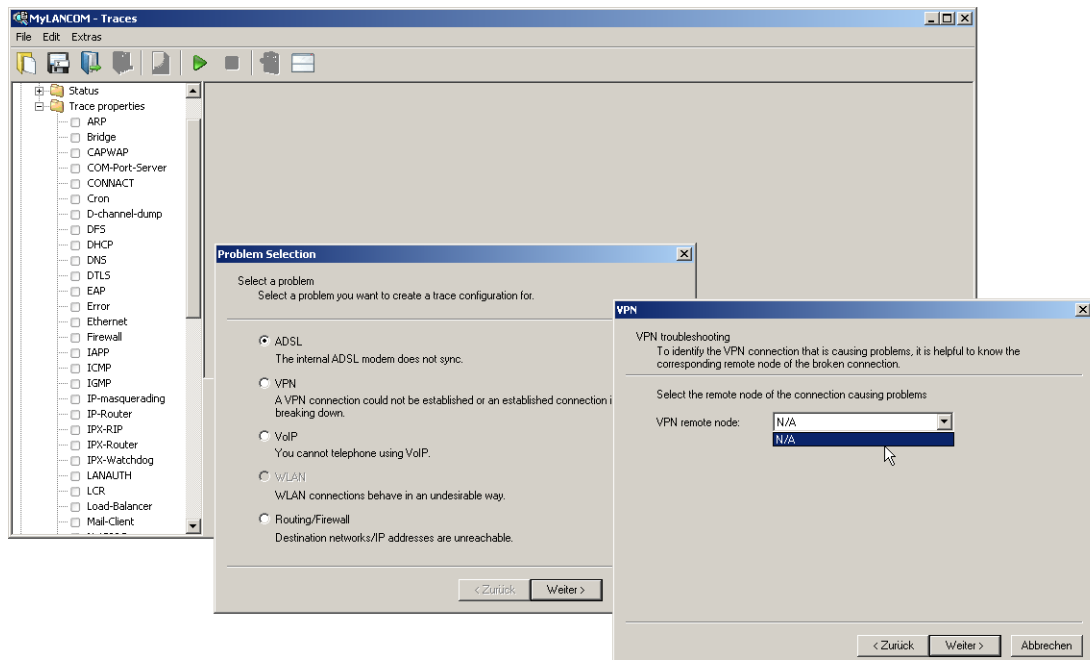

### 5.2.3 LCOS menu tree of the trace dumps

Going beyond the settings of the Wizard, traces and other displays can be set up precisely using the LCOS menu tree. The LCOS menu tree is divided into three areas:

- Show

Particular information can be retrieved for every device type using a Show command. Show commands are usually used on the command line (Telnet). The call of this Show command is very convenient from the graphical Windows interface in the advanced configuration of the trace.

To access the current dump of the Show command, click the name of a Show command in the left-hand area of the trace dialog and then the Show button. You may have to/be able to specify additional parameters depending on the entry selected. Enter a question mark in the input field and then click the Show button for information on these parameters.

To accept the dump of the Show command into the trace data, click the appropriate checkbox to the left of the entry name. For every Show command enabled, it is possible to set whether it is only run once on start of the trace or whether it is run at regular intervals (set in seconds).

! The settings of the Show commands are stored in the trace configuration together with the actual trace settings.

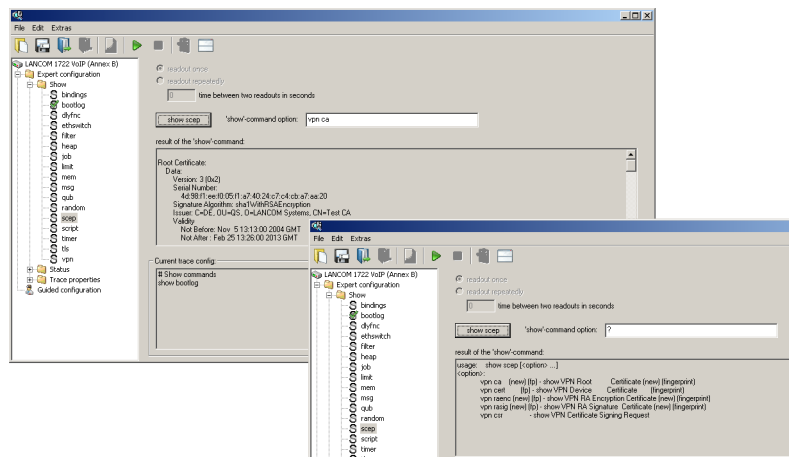

- Status

Comprehensive status information and statistics on a device can be accessed from the command line (Telnet) or via WEBconfig. All available status information can also be shown via the trace dialog. Tables and individual values are shown using special icons.

To display the current contents of the table or value, click the name of a status entry in the left-hand area of the trace dialogue.

To accept the dump of the Status entry into the trace data, click the appropriate checkbox to the left of the entry name. For every Status entry enabled, a setting defines whether it is read out once only on starting the trace or whether it is read out at regular intervals (set in seconds).

- ! The settings of the Status information are stored in the trace configuration together with the actual trace settings. Status information is stored together with the actual trace data.

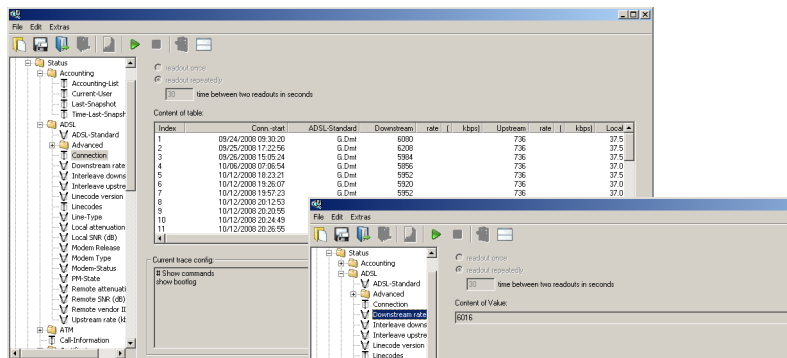

#### Trace settings

The traces to be dumped for the current device can be enabled in the trace settings area.

To accept the dump of the trace into the trace data, click the appropriate checkbox to the left of the entry name. A filter can be entered for every trace. For example, if you want to display only the IP traces of a particular workstation, enter the appropriate IP address as a filter of the IP router trace.

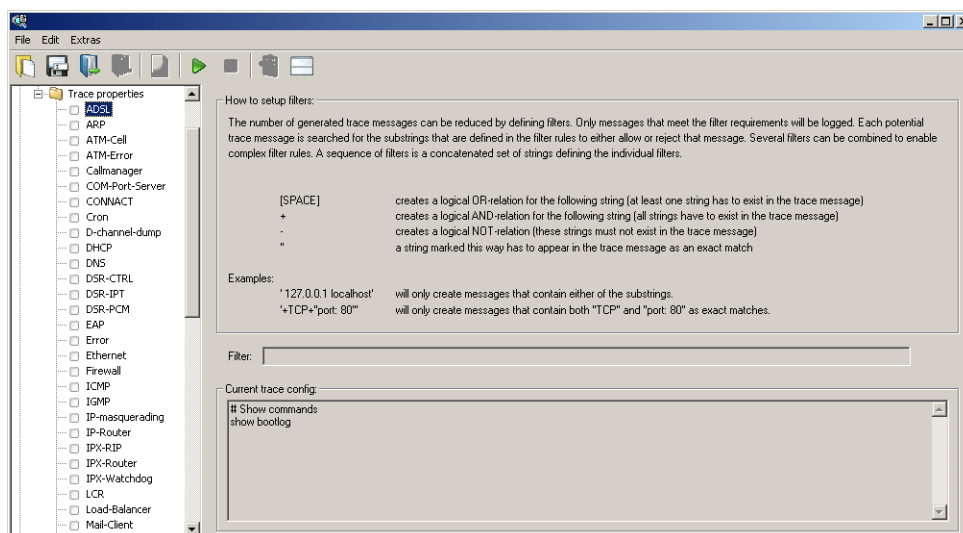

### 5.2.4 Display of trace data

The entire trace configuration is shown in the lower area of the dialog where all active Trace, Status and Show entries are listed with the respective filters and parameters.

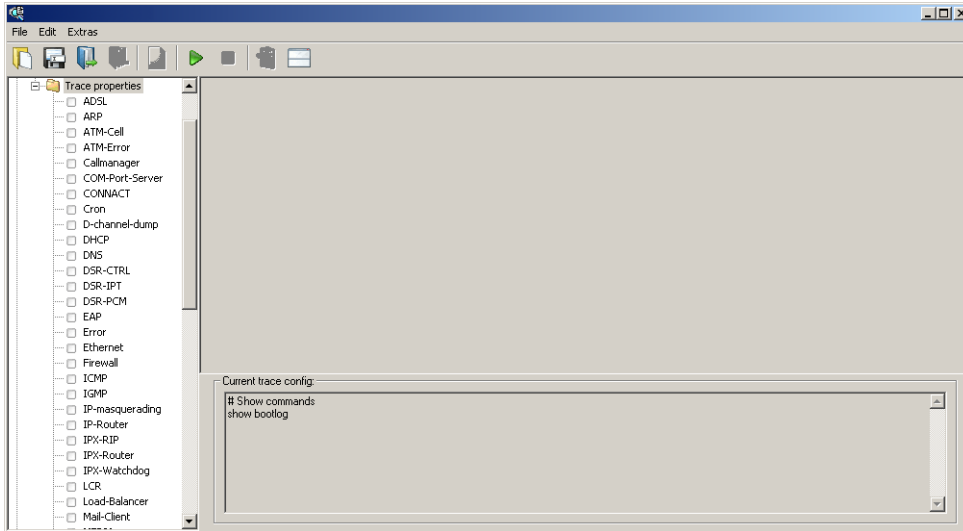

To start the dump of the trace data, change to Display mode with the Start button. The ongoing trace dumps are displayed in this view:

- The trace events are listed chronologically in the upper area.
- The lower area lists the results of the events in sequence.

For easier navigation within long trace dumps, click a trace event in the upper area. The appropriate result is then enabled in the list and highlighted green.

Right-clicking a trace event opens up a context menu from where individual trace results can be shown/hidden.



Trace data is collected as long as the trace dump is enabled. To prevent overloading the main workstation memory using LANmonitor, trace data is automatically written to a backup file. The time intervals and the maximum size of a backup file can be set with **Extras / Other Settings / Trace backup**.

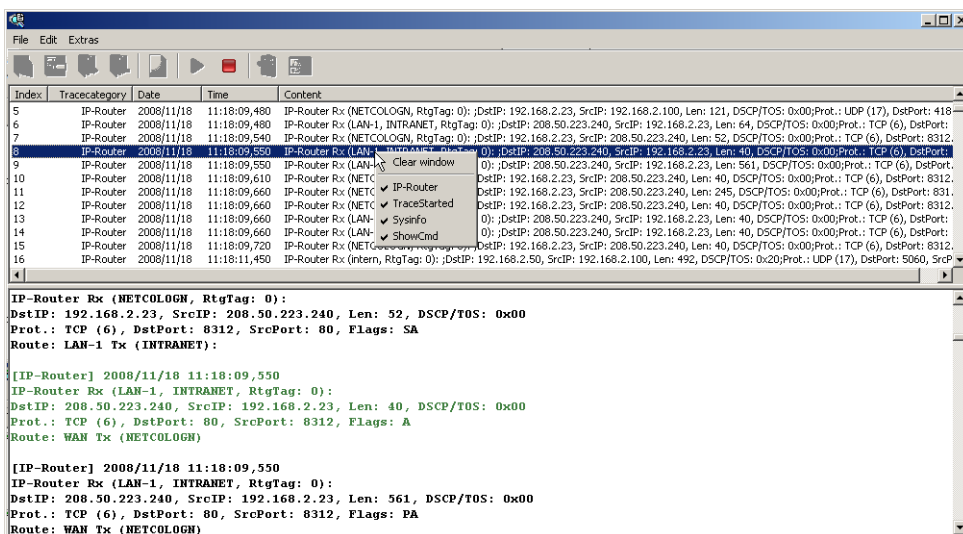

## 5.2.5 Backing up and restoring the trace configuration

The entire configuration of the trace dump can be written to a storage medium for later re-use or for transfer to another user. Click on **File / Store trace configuration** and re-open it later with **File / Load trace configuration**.

## 5.2.6 Backing up and restoring the trace data

For later editing, or for transfer to another user, the actual trace data can be written to a storage medium with **File / Store trace data** and later re-opened with **File / Load trace data**.

## 5.2.7 Backup settings for traces

When starting a trace with LANmonitor, a backup file with the current trace data is automatically saved. The settings for the trace backup can be configured with **Extras / Other settings / Trace backup**. Enter the following parameters:

- Directory for the trace backups
- Maximum size of a trace backup file. If this file size is reached with an active trace, another trace backup file is created automatically.
- Save interval of the trace backup file. When this time has elapsed, an updated version of the trace backup file is saved automatically. The trace backup file therefore does not contain the information from the most recent backup up to the current time.
- LANmonitor can set current workstation time as a time for the trace, for example when the traced device itself does not have valid time information.

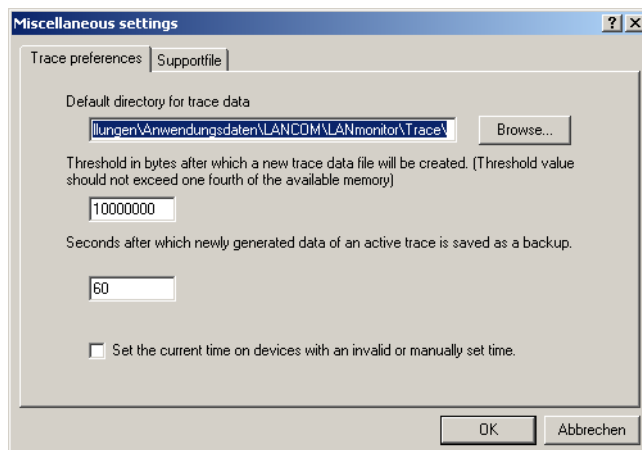

## 5.2.8 Saving support file

A support file enables all information pertaining to support to be easily written to one file:

- Trace data as configured in the current settings (such as with function "Save trace data")
- Current device configuration
- Bootlog
- Sysinfo

When saving the device configuration, security-related information of no relevance to support can be hidden. Use **Extras / Other settings / Support file** in the trace window to select which information is not to be saved in the support file:

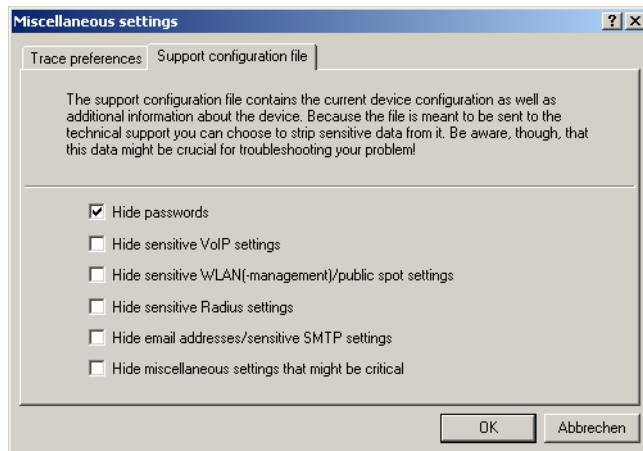

! The support file created this way contains text-based information. The file can be opened using an editor or checked for any critical entries.

## 5.2.9 Addition(s) to LCOS 8.50

### LANtracer: Tracing with LANconfig and LANmonitor

Traces can be executed very easily with LANconfig or LANmonitor. Simply click on the entry for the device with the right-hand mouse key and select Traces from the context menu.

! Telnet-access to the device must be enabled to carry out trace requests with LANconfig or LANmonitor. When starting the trace dialog, LANconfig or LANmonitor first attempts to establish an SSL-encrypted Telnet connection to the device. If the device does not support SSL connections, LANconfig or LANmonitor automatically switches to unencrypted Telnet. If access to the device configuration is password-protected, the access data for an administrator with trace rights is also required.

#### Introduction

The trace function in LANconfig and LANmonitor exceeds the standard trace functions available from Telnet and offers greater convenience in the generation and analysis of traces. For example, the current trace configuration for activating the necessary trace commands can be stored to a configuration file. An experienced service technician can set up a trace configuration and provide it to a less experienced user for executing specialized trace requests for a device. The trace results can also be stored in a file and returned to the technician for analysis.

To open the trace window for a device, right-click the device entry in LANconfig or LANmonitor and select "Create trace output" from the context menu.

LANmonitor has the following buttons for operating the trace module:



Opens a pre-defined configuration for the trace command. This allows you to carry out trace commands precisely as required by the service technician, for example.



Stores the current trace configuration or the trace data to be passed on to a user.



Clears the current display or trace results.



Starts outputting the trace results as produced by the current configuration and automatically switches to the trace-result display mode. As soon as the trace results are returned, the other buttons are deactivated.



Stops the output of trace results.



Switches to the mode for configuring the trace output.



Switches to the mode for displaying the trace output.



Switches to the split-screen mode to display the trace results in two parallel windows.



Opens the window to search through the trace results.



Starts the time-stamp based synchronization of the two traces in the split-screen display.



Stops the synchronization of the two traces in the split-screen display.

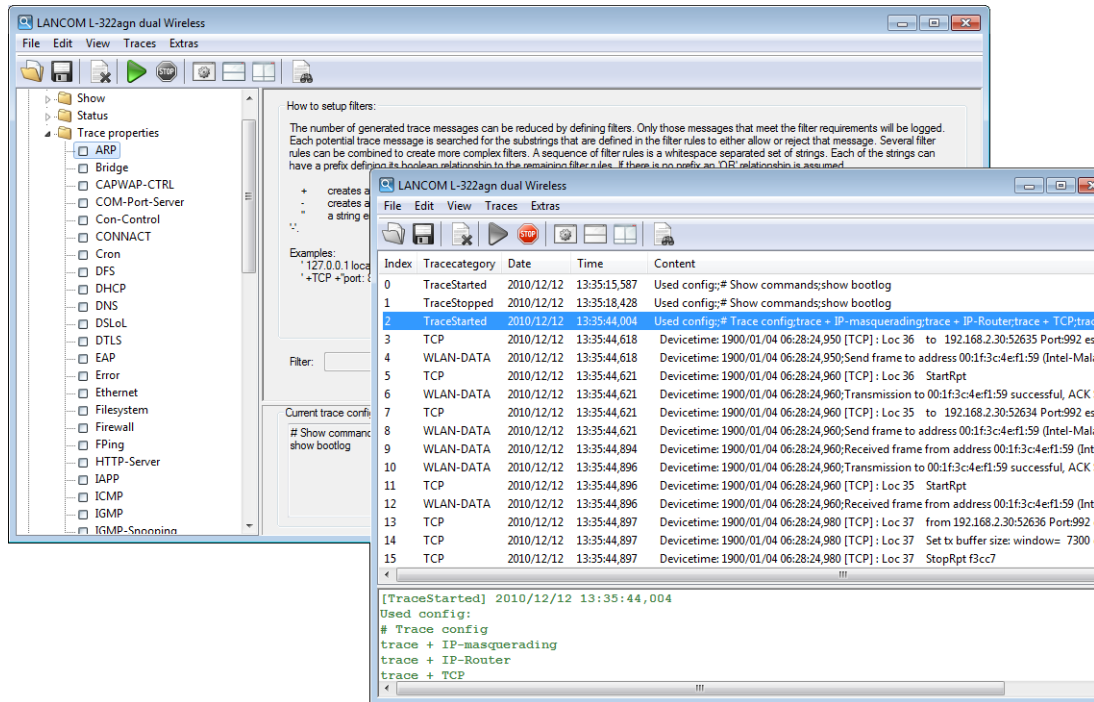

### Expert configuration of the trace dumps

Going beyond the settings of the Wizard, traces and other displays can be set up precisely using the Expert Configuration. The Expert Configuration is divided into three areas:

#### Show

Particular information can be retrieved for every device type using a Show command. Show commands are usually used on the command line (Telnet). The call of this Show command is very convenient from the graphical Windows interface in the advanced configuration of the trace. To access the current dump of the Show command, click the name of a Show command in the left-hand area of the trace dialog and then the Show button. You may have to/be able to specify additional parameters depending on the entry selected. Enter a question mark in the input field and then click the Show button for information on these parameters. To accept the dump of the Show command into the trace data, click the appropriate checkbox to the left of the entry name. For every Show command enabled, it is possible to set whether it is only run once on start of the trace or whether it is run at regular intervals (set in seconds).



! The settings of the Show commands are stored in the trace configuration together with the actual trace settings.

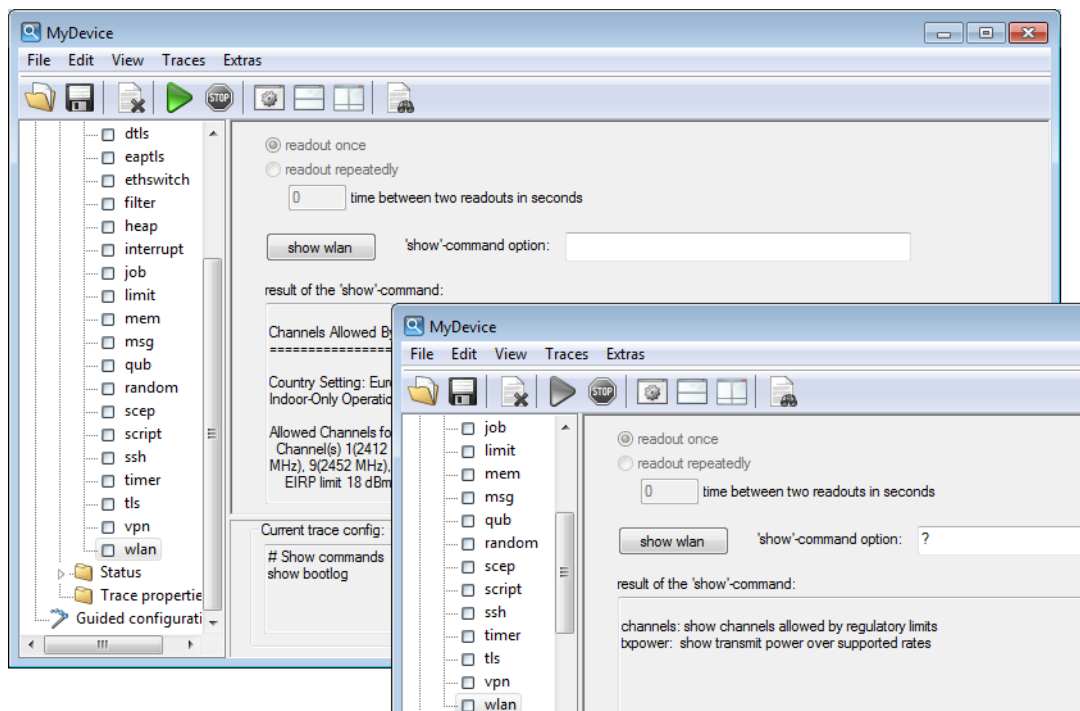

## Status

Comprehensive status information and statistics on a device can be accessed from the command line (Telnet) or via WEBconfig. All available status information can also be shown via the trace dialog. Tables and individual values are shown using special icons. To display the current contents of the table or value, click the name of a status entry in the left-hand area of the trace dialogue. To accept the dump of the Status entry into the trace data, click the appropriate checkbox to the left of the entry name. For every Status entry enabled, a setting defines whether it is read out once only on starting the trace or whether it is read out at regular intervals (set in seconds).

! The settings of the Status information are stored in the trace configuration together with the actual trace settings. Status information is stored together with the actual trace data.

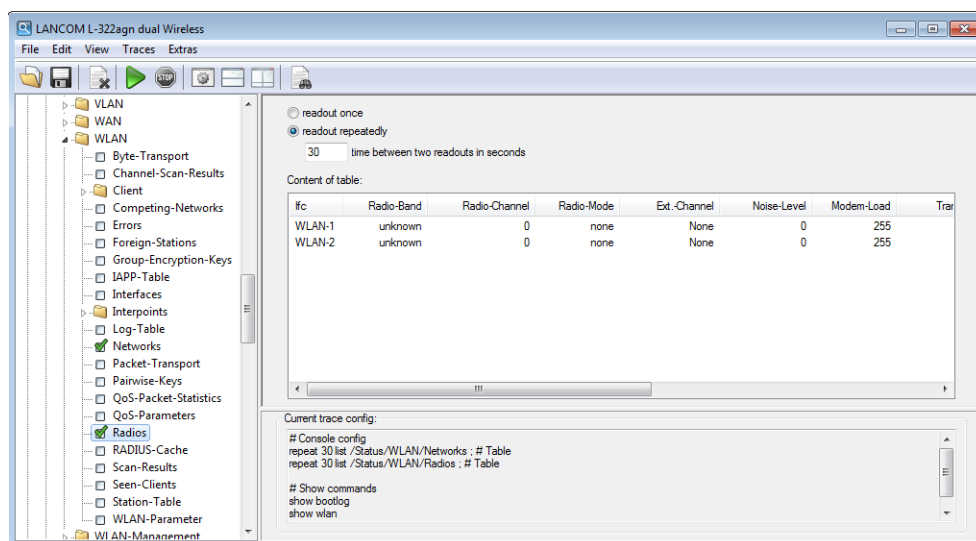

### Trace settings

The traces to be dumped for the current device can be enabled in the trace settings area. To include the trace commands into the trace results, click the appropriate checkbox to the left of the entry name. A filter can be entered for every trace. For example, if you want to display only the IP traces of a particular workstation, enter the appropriate IP address as a filter of the IP router trace.

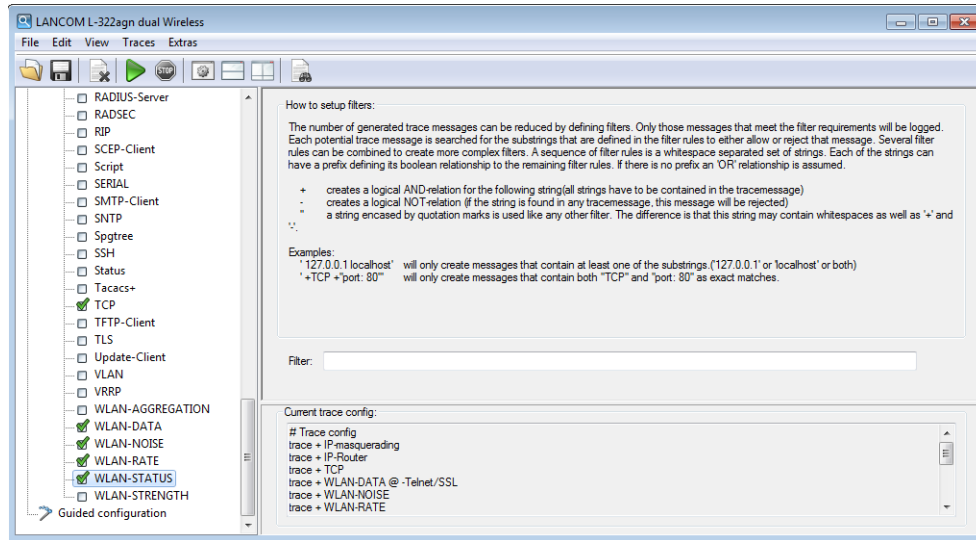

### Display of the trace results

The entire trace configuration is shown in the lower area of the dialog where all active Trace, Status and Show entries are listed with the respective filters and parameters.

To start the dump of the trace data, change to Display mode with the Start button.

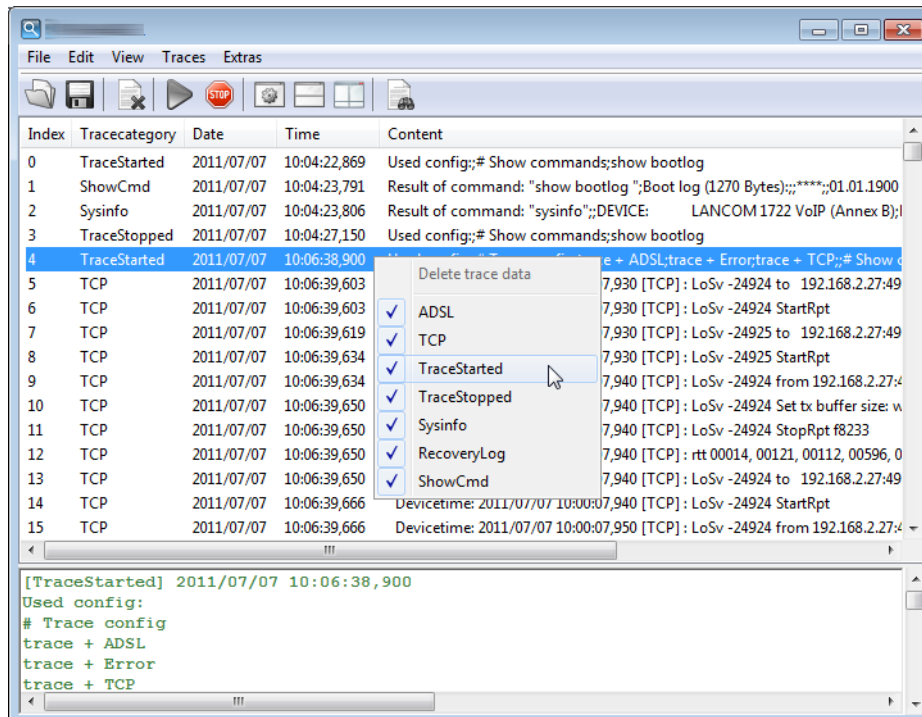

If you want to compare the results of two traces with one another, you can display two traces side by side in the split-screen mode.

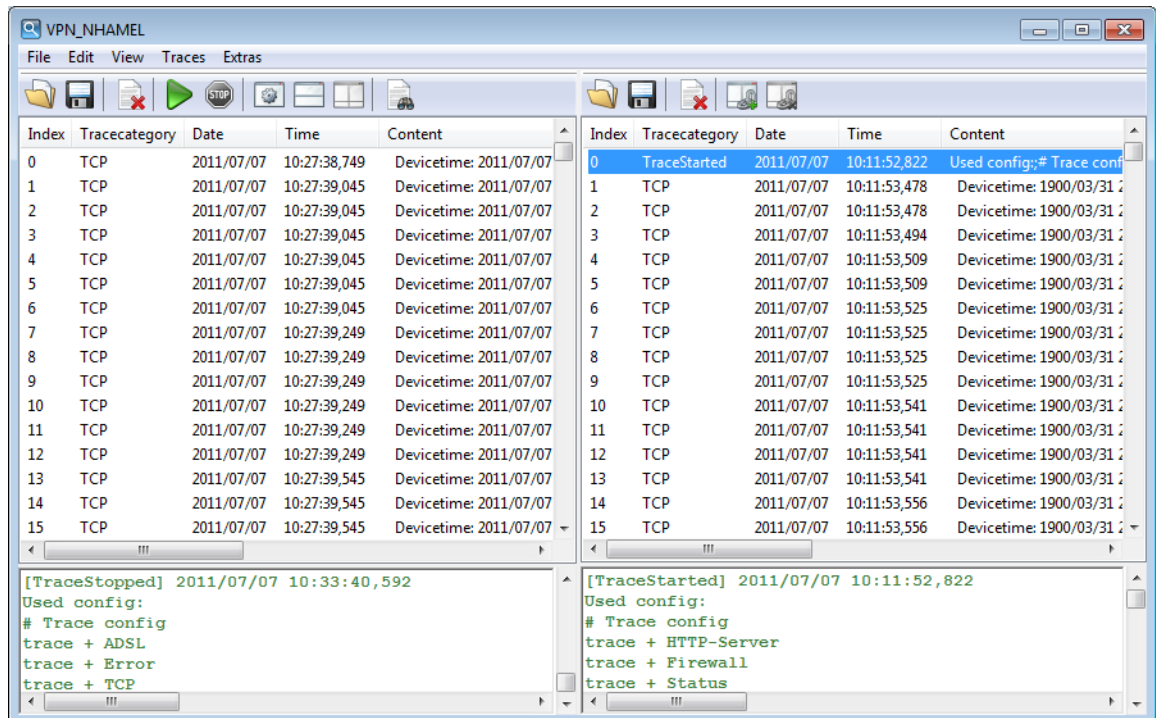

Start the time-stamp based synchronization of the two traces with the  button. In the following window, enter a suitable value for the offset in milliseconds and start the synchronization.

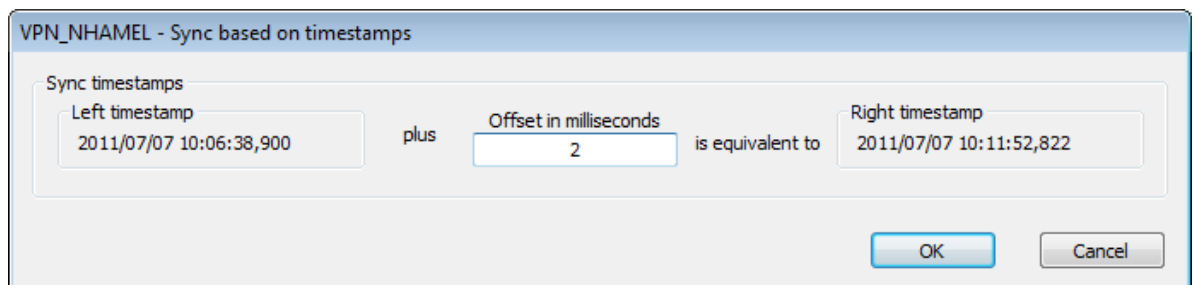

The ongoing trace dumps are displayed in this view:

- The upper section lists the results for the executed trace commands chronologically line by line.
- Since the results for a single trace command can be very long, the lower section shows a more detailed breakdown of the result selected in the upper section.

For easier navigation within long trace dumps, click a trace event in the upper area. The appropriate result is then enabled in the list and highlighted in green. Right-clicking a trace event opens up a context menu from where individual trace results can be shown/hidden.

 Trace data is collected as long as the trace dump is enabled. To prevent overloading the main workstation memory using LANconfig or LANmonitor, trace data is automatically written to a backup file. The time intervals and the maximum size of a backup file can be set with 'Extras > Other Settings > Trace backup'.

### Backing up and restoring the trace configuration

The entire configuration of the trace dump can be written to a storage medium for later re-use or for transfer to another user. Click on 'File > Save trace config' and re-open it later with 'File > Load trace config'.

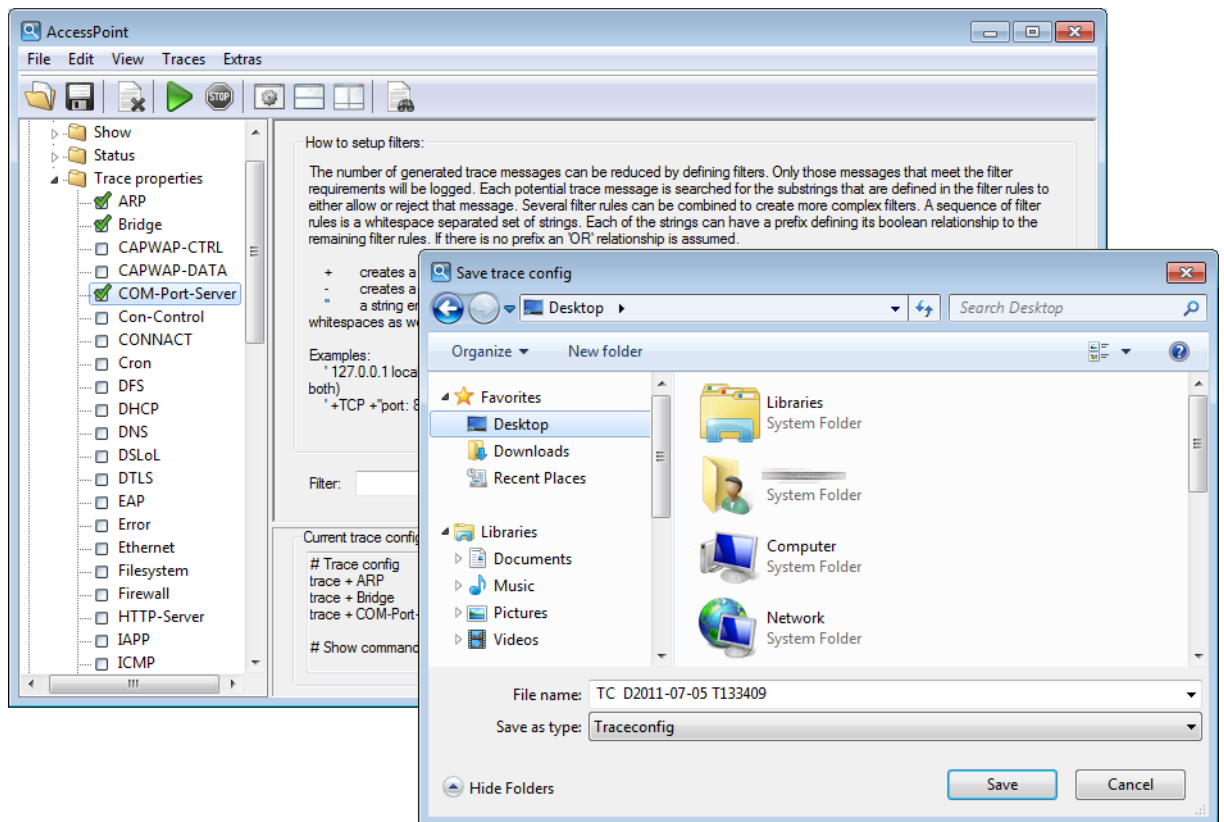

### Backing up and restoring the trace data

For later editing, or for transfer to another user, the actual trace data can be written to a storage medium with 'File > Save trace data/support configuration' and later re-opened with 'File > Load trace data'.

Alternatively, you can also use the buttons  to load or  to save the trace data.

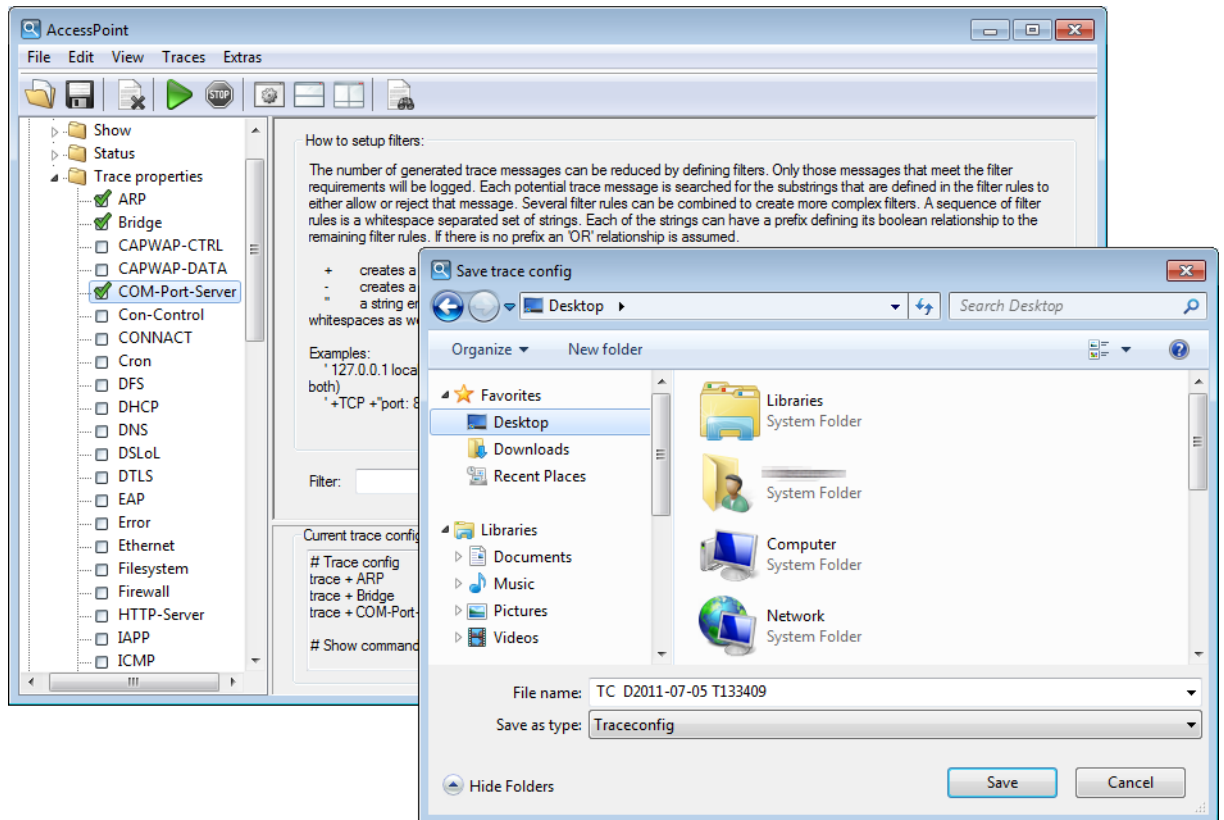

### Backup settings for traces

When starting a trace with LANconfig or LANmonitor, a backup file with the current trace data is automatically saved. The settings for the trace backup can be configured with 'Extras > Other settings > Trace' backup. Enter the following parameters:

- Directory for the trace backups
- Maximum size of a trace backup file. If this file size is reached with an active trace, another trace backup file is created automatically.
- Save interval of the trace backup file. When this time has elapsed, an updated version of the trace backup file is saved automatically. The trace backup file therefore does not contain the information from the most recent backup up to the current time.

- LANmonitor can set current workstation time as a time for the trace, for example when the traced device itself does not have valid time information.

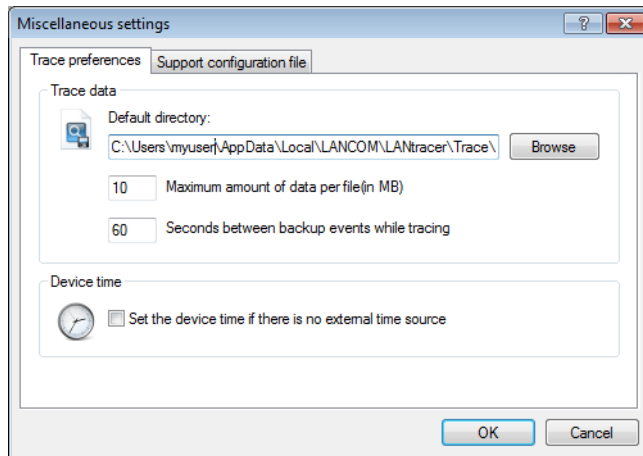

### Filtering traces

Trace output from the command line or the LCMS Trace dialog can often be very long, because the trace receives information from the device at a very high frequency. To make the trace output easier to understand, you can apply appropriate filters. The filters use a search function to analyze the trace output and present the desired information only.

In the following example, the administrator activates a simple IP router trace on a device with three Internet connections and sends pings to different destinations. The unfiltered trace output shows all packets processed by the IP router in the device:

```

root@MyDevice:/
> trace # ip-router
IP-Router ON

root@MyDevice:/

>[IP-Router] 2010/12/20 17:11:06,430
IP-Router Rx (LAN-1, INTRANET3, RtgTag: 3):
DstIP: 4.4.4.1, SrcIP: 192.168.3.100, Len: 84, DSCP/TOS: 0x00
Prot.: ICMP (1), echo request, id: 0x0015, seq: 0x1cde
Route: WAN Tx (INTERNET3)

[IP-Router] 2010/12/20 17:11:06,430
IP-Router Rx (LAN-1, INTRANET1, RtgTag: 1):
DstIP: 11.11.11.1, SrcIP: 192.168.1.100, Len: 84, DSCP/TOS: 0x00
Prot.: ICMP (1), echo request, id: 0x0016, seq: 0x1ccf
Route: WAN Tx (INTERNET1)

[IP-Router] 2010/12/20 17:11:06,430
IP-Router Rx (INTERNET1, RtgTag: 1):
DstIP: 192,168.1,100, SrcIP: 11.11.11.1, Len: 84, DSCP/TOS: 0x00
Prot.: ICMP (1), echo reply, id: 0x0016, seq: 0x1ccf
Route: LAN-1 Tx (INTRANET1):

[IP-Router] 2010/12/20 17:11:06,430
IP-Router Rx (INTERNET3, RtgTag: 3):
DstIP: 192,168.3,100, SrcIP: 44.41, Len: 84, DSCP/TOS: 0x00
Prot.: ICMP (1), echo reply, id: 0x0015, seq: 0x1cde
Route: LAN-1 Tx (INTRANET3):

[IP-Router] 2010/12/20 17:11:06,600
IP-Router Rx (LAN-1, INTRANET2, RtgTag: 2):

```

```

DstIP: 3.3.3.1, SrcIP: 192.168.2.100, Len: 84, DSCP/TOS: 0x00
Prot.: ICMP (1), echo request, id: 0x0014, seq: 0xlcea
Route: WAN Tx (INTERNET2)

[IP-Router] 2010/12/20 17:11:06,600
IP-Router Rx (INTERNET2, RtgTag: 2):
DstIP: 192,168.2,100, SrcIP: 33.31, Len: 84, DSCP/TOS: 0x00
Prot.: ICMP (1), echo reply, id: 0x0014, seq: 0xlcea
Route: LAN-1 Tx (INTRANET2):

[IP-Router] 2010/12/20 17:11:07,430
IP-Router Rx (LAN-1, INTRANET1, RtgTag: 1):
DstIP: 11.11.11.1, SrcIP: 192.168.1.100, Len: 84, DSCP/TOS: 0x00
Prot.: ICMP (1), echo request, id: 0x0016, seq: 0xlcd0
Route: WAN Tx (INTERNET1)

[IP-Router] 2010/12/20 17:11:07,430
IP-Router Rx (LAN-1, INTRANET3, RtgTag: 3):
DstIP: 4.4.4.1, SrcIP: 192.168.3.100, Len: 84, DSCP/TOS: 0x00
Prot.: ICMP (1), echo request, id: 0x0015, seq: 0xlcdf
Route: WAN Tx (INTERNET3)

[IP-Router] 2010/12/20 17:11:07,430
IP-Router Rx (INTERNET1, RtgTag: 1):
DstIP: 192,168.1,100, SrcIP: 11.11.11.1, Len: 84, DSCP/TOS: 0x00
Prot.: ICMP (1), echo reply, id: 0x0016, seq: 0xlcd0
Route: LAN-1 Tx (INTRANET1):

[IP-Router] 2010/12/20 5:11:07 PM,430
IP-Router Rx (INTERNET3, RtgTag: 3):
DstIP: 192,168.3,100, SrcIP: 44.41, Len: 84, DSCP/TOS: 0x00
Prot.: ICMP (1), echo reply, id: 0x0015, seq: 0xlcdf
Route: LAN-1 Tx (INTRANET3):

[IP-Router] 2010/12/20 5:11:07 PM,600
IP-Router Rx (LAN-1, INTRANET2, RtgTag: 2):
DstIP: 3.3.3.1, SrcIP: 192.168.2.100, Len: 84, DSCP/TOS: 0x00
Prot.: ICMP (1), echo request, id: 0x0014, seq: 0xlceb
Route: WAN Tx (INTERNET2)

[IP-Router] 2010/12/20 5:11:07 PM,600
IP-Router Rx (INTERNET2, RtgTag: 2):
DstIP: 192,168.2,100, SrcIP: 33.31, Len: 84, DSCP/TOS: 0x00
Prot.: ICMP (1), echo reply, id: 0x0014, seq: 0xlceb
Route: LAN-1 Tx (INTRANET2):

```

The output in just 2 seconds is enough to produce a large amount of data. For a better overview of the output, add a filter to the trace command. The filters start with the @ symbol and enter a search criterion. In this example, the filter reduces the output to that containing the search criterion "Internet1", in order to output only the packets from this remote site.



The filter is not case-sensitive.

```

root@MyDevice:/
> trace # ip-router @ INTERNET1

IP-Router ON @ INTERNET1

[IP-Router] 2010/12/20 17:11:50,430
IP-Router Rx (LAN-1, INTRANET1, RtgTag: 1):
DstIP: 11.11.11.1, SrcIP: 192.168.1.100, Len: 84, DSCP/TOS: 0x00
Prot.: ICMP (1), echo request, id: 0x0016, seq: 0xlcfb

```

```

Route: WAN Tx (INTERNET1)

[IP-Router] 2010/12/20 5:11:50 PM,430
IP-Router Rx (INTERNET1, RtgTag: 1):
DstIP: 192,168.1,100, SrcIP: 11.11.11.1, Len: 84, DSCP/TOS: 0x00
Prot.: ICMP (1), echo reply, id: 0x0016, seq: 0x1cfb
Route: LAN-1 Tx (INTRANET1):

[IP-Router] 2010/12/20 5:11:51 PM,430
IP-Router Rx (LAN-1, INTRANET1, RtgTag: 1):
DstIP: 11.11.11.1, SrcIP: 192.168.1.100, Len: 84, DSCP/TOS: 0x00
Prot.: ICMP (1), echo request, id: 0x0016, seq: 0x1cfc
Route: WAN Tx (INTERNET1)

[IP-Router] 2010/12/20 5:11:51 PM,430
IP-Router Rx (INTERNET1, RtgTag: 1):
DstIP: 192,168.1,100, SrcIP: 11.11.11.1, Len: 84, DSCP/TOS: 0x00
Prot.: ICMP (1), echo reply, id: 0x0016, seq: 0x1cfc
Route: LAN-1 Tx (INTRANET1):

```

Again, the time frame of the trace is about two seconds, but the amount of data has already been reduced significantly. The only data to be displayed is that relating to remote site "INTERNET1". However, further filter criteria can also be specified simply by placing a space between the first and second criteria. As well as a space symbol, the symbols "+" and "-" can also be used as operators. With a "+" both criteria must be met; with a "-" the criterion must not be fulfilled; a space means that one or the other of the associated criteria must be fulfilled. The option to use strings containing operators as a filter is implemented by quotation marks:

If you want to apply multiple search terms, you can separate the terms with the following operators:

- Space: A space before a search term is a logical OR operation. The trace output is only displayed if it contains one of the strings marked in this way.
- +: A plus sign before a search term is a logical AND operation. The trace output is only displayed if it contains all of the strings marked in this way.
- -: A minus sign before a search term is a logical NOT operation. The trace output is only displayed if it contains none of the strings marked in this way.

```

root@MyDevice:/
> trace # ip-router @ INTERNET1 -"echo request"

IP-Router ON @ INTERNET1 -"echo request"

[IP-Router] 2010/12/20 17:12:06,430
IP-Router Rx (INTERNET1, RtgTag: 1):
DstIP: 192,168.1,100, SrcIP: 11.11.11.1, Len: 84, DSCP/TOS: 0x00
Prot.: ICMP (1), echo reply, id: 0x0016, seq: 0x1d0b
Route: LAN-1 Tx (INTRANET1):

[IP-Router] 2010/12/20 17:12:07,430
IP-Router Rx (INTERNET1, RtgTag: 1):
DstIP: 192,168.1,100, SrcIP: 11.11.11.1, Len: 84, DSCP/TOS: 0x00
Prot.: ICMP (1), echo reply, id: 0x0016, seq: 0x1d0c
Route: LAN-1 Tx (INTRANET1):

```

The trace now shows only the entries that contain the remote site 'INTERNET1', but **not** the string 'echo request'. This displays only the responses to a ping as they return from the remote site.

You can use multiple traces simultaneously and filter by different criteria. In the following example, an Ethernet trace is run in addition to the IP router trace to see the packet associated with the ping on the Ethernet:

```

root@MyDevice:/
> trace # ip-router @ INTERNET1 +"echo reply"
IP-Router ON @ INTERNET1 +"echo reply"

```



```

root@MyDevice:/
> trace # eth @ ICMP +"echo reply"
Ethernet ON @ icmp +"echo reply"

[IP-Router] 2010/12/21 14:17:21,000
IP-Router Rx (INTERNET1, RtgTag: 1):
DstIP: 192,168.1,100, SrcIP: 11.11.11.1, Len: 84, DSCP/TOS: 0x00
Prot.: ICMP (1), echo reply, id: 0x0002, seq: 0x2654
Route: LAN-1 Tx (INTRANET1):

[Ethernet] 2010/12/21 14:17:21,000
Sent 98 byte Ethernet packet via LAN-1:
HW Switch Port : ETH-1
-->IEEE 802.3 Header
Dest : 00:a0:57:12:a9:21 (LANCOM 12:a9:21)
Source : 00:a0:57:12:f7:81 (LANCOM 12:f7:81)
Type : IPv4
-->IPv4 Header
Version : 4
Header Length : 20
Type of service : (0x00) Precedence 0
Total length : 84
ID : 18080
Fragment : Offset 0
TTL : 59
Protocol : ICMP
Checksum : 24817 (OK)
Src Address : 11.11.11.1
Dest Address : 192.168.1.100
-->ICMP Header
Msg : echo reply
Checksum : 18796 (OK)
Body : 00 00 00 02 00 00 26 54
 7e c9 6d 8c 00 00 00 00 ~.m.....
 00 01 02 03 04 05 06 07
 08 09 0a 0b 0c 0d 0e 0f
 10 11 12 13 14 15 16 17
 18 19 1a 1b 1c 1d 1e 1f
 20 21 22 23 24 25 26 27 !"#$%

```

### Saving a support file

A support file enables all information pertaining to support to be easily written to one file:

- Trace data as configured in the current settings (such as with function "Save trace data")
- Current device configuration
- Bootlog
- Sysinfo

When saving the device configuration, security-related information of no relevance to support can be hidden. Use 'Extras > Other settings > Support file' in the trace window to select which information is not to be saved in the support file:

- ! The support file created this way contains text-based information. The file can be opened using an editor or checked for any critical entries.

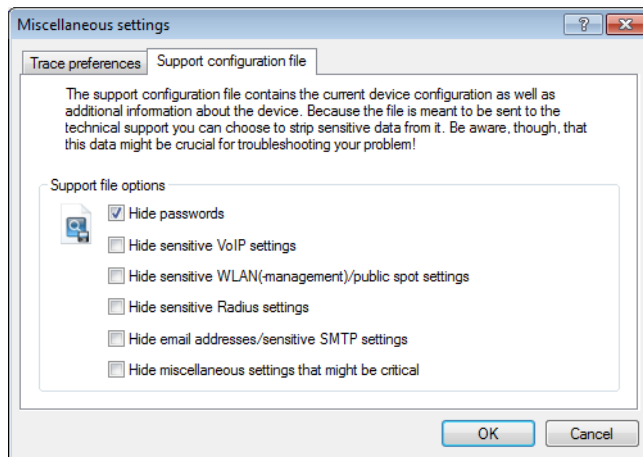

## 5.3 SYSLOG

### 5.3.1 Introduction

The SYSLOG protocol is used to log the activities of a LANCOM device. This function is especially interesting for system administrators as it records a complete history of all activities in the device. The information captured in the SYSLOG log can be viewed in different ways:

- SYSLOG messages can be sent to a central "collection point", a so-called SYSLOG client or SYSLOG daemon. This option is useful, for example, when messages from a large number of devices are to be logged.
  - Logging under UNIX/Linux is generally performed by the SYSLOG daemon that is set up as standard in these operating systems. The daemon either establishes contact with the console or writes its log to an appropriate SYSLOG file. The file `/etc/syslog.conf` contains a definition of which facilities (more on this term later) should be written to which log file. Please check your daemon's configuration to see if it explicitly listens to network connections.
  - Windows does not provide a corresponding system function. You require special software to provide the functionality of a SYSLOG daemon.
  - Syslog in the device memory.
- To extend the output of the SYSLOG information over an appropriate SYSLOG client, the most recent SYSLOG messages are stored in the device's RAM. Depending on the memory fitted, this can vary from 100 to 2048 syslog messages. These internal syslogs can be viewed in various ways:
  - In the device statistics via the command line, e.g. with telnet
  - In WEBconfig under /System information/Syslog
  - LANmonitor additionally lets you export the syslog from the device and save it to a file. Simply click on the entry for the device with the right mouse button and select **View Syslog** from the context menu. A snapshot of the current status is displayed. Clicking on **Refresh** exports a copy of the current syslog and this is displayed in the window. **Save syslog...** stores the current display to a file. The content of syslog files can be viewed with **Load syslog...**

- ! SYSLOG messages will only be written to the device's internal memory if the LANCOM was entered as a SYSLOG client with the loopback address 127.0.0.1.

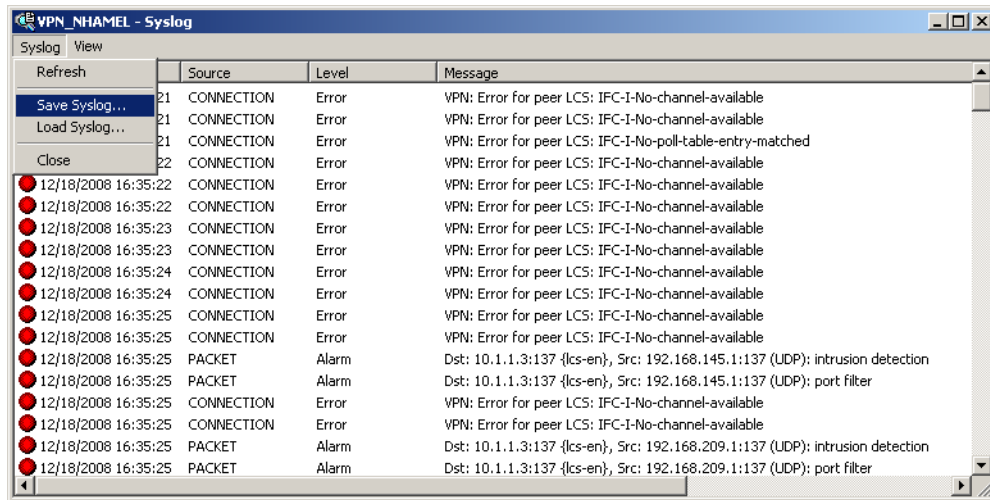

Alternatively you can view the current SYSLOG messages on the first page of WEBconfig on the SYSLOG tab:

Idx.	Time	Source	Level	Message
743	11/11/2008 14:55:53	LOCAL3	Alarm	Dst: 10.1.1.5:139 {lcs-data}, Src: 192.168.8.1:14132 (TCP): port filter
744	11/11/2008 14:55:53	LOCAL3	Alarm	Dst: 10.1.1.5:139 {lcs-data}, Src: 192.168.202.1:14133 (TCP): intrusion detectic
745	11/11/2008 14:55:53	LOCAL3	Alarm	Dst: 10.1.1.5:139 {lcs-data}, Src: 192.168.202.1:14133 (TCP): port filter
746	11/11/2008 14:55:54	LOCAL3	Alarm	Dst: 10.1.1.5:139 {lcs-data}, Src: 192.168.8.1:14137 (TCP): intrusion detection
747	11/11/2008 14:55:54	LOCAL3	Alarm	Dst: 10.1.1.5:139 {lcs-data}, Src: 192.168.8.1:14137 (TCP): port filter
748	11/11/2008 14:55:54	LOCAL3	Alarm	Dst: 10.1.1.5:139 {lcs-data}, Src: 192.168.202.1:14138 (TCP): intrusion detectic
749	11/11/2008 14:55:54	LOCAL3	Alarm	Dst: 10.1.1.5:139 {lcs-data}, Src: 192.168.202.1:14138 (TCP): port filter
750	11/11/2008 15:13:34	LOCAL3	Alarm	Dst: 192.168.2.100:22338 (VPN_NHAMEL), Src: 192.168.2.47:5000 {evb3-00a}
751	11/11/2008 15:13:34	LOCAL3	Alarm	Dst: 192.168.2.100:22338 (VPN_NHAMEL), Src: 192.168.2.47:5000 {evb3-00a}
752	11/11/2008 15:13:34	LOCAL3	Alarm	Dst: 192.168.2.100:22338 (VPN_NHAMEL), Src: 192.168.2.47:5000 {evb3-00a}
753	11/11/2008 15:13:34	LOCAL3	Alarm	Dst: 192.168.2.100:22338 (VPN_NHAMEL), Src: 192.168.2.47:5001 {evb3-00a}
754	11/11/2008 16:37:19	LOCAL3	Alarm	Dst: 10.1.1.5:139 {lcs-data}, Src: 192.168.8.1:16446 (TCP): intrusion detection
755	11/11/2008 16:37:19	LOCAL3	Alarm	Dst: 10.1.1.5:139 {lcs-data}, Src: 192.168.8.1:16446 (TCP): port filter
756	11/11/2008 16:37:19	LOCAL3	Alarm	Dst: 10.1.1.5:139 {lcs-data}, Src: 192.168.202.1:16447 (TCP): intrusion detectic

## 5.3.2 Structure of SYSLOG messages

SYSLOG messages consist of three parts:

- Priority
- Header
- Contents

### Priority

The priority in a SYSLOG message contains information about the the message severity and the facility (service or component that triggered the message).

The eight severity levels originally defined in SYSLOG have been reduced to five levels in the LANCOM. The table below shows the correlation between the LANCOM alarm level, the meaning and the SYSLOG severities.

Priority	Meaning	SYSLOG severity
Alarm	This category includes all messages requiring the system administrator's close attention.	PANIC, ALERT, CRIT
Error	All error messages which can occur under normal conditions are communicated at this level; no special attention is required by the administrator (e.g. connection errors).	ERROR

## 5 Diagnosis

Priority	Meaning	SYSLOG severity
Warning	This level communicates messages which do not compromise normal operating conditions.	WARNING
Information	At this level, all messages are sent that have a purely informational character (e.g. accounting information).	NOTICE, INFORM
Debug	Communication of all debug messages. Debug messages generate large data volumes and can compromise the device's operation. For this reason they should be disabled for normal operations and only used for troubleshooting.	DEBUG

The table below provides an overview of the meaning of all internal message sources that you can set in the LANCOM. The final column in the table also provides the standard correlation between the internal sources of the LANCOM and the SYSLOG facilities. This mapping can be changed, if necessary.

Source	Meaning	Facility
System	System messages (boot events, timer system, etc.)	KERNEL
Logins	Messages concerning the user's login or logout during the PPP negotiation, and any errors that occur during this.	AUTH
System time	Messages about changes to the system time	CRON
Console logins	Messages about console logins (Telnet, Outband, etc.), logouts and any errors that occurred during this.	AUTHPRIV
Connections	Messages about establishment and termination of connections and any errors that occurred (display trace)	LOCAL0
Accounting	Accounting information stored after termination of a connection (user, online time, transfer volumes)	LOCAL1
Administration	Messages on changes to the configuration, remotely executed commands, etc.	LOCAL2
Router	Regular statistics about the most frequently used services (breakdown per port number) and messages about filtered packets, routing errors, etc.	LOCAL3

## Header

The header contains the name or the IP address of the device which sent the SYSLOG message. The chronological sequence is also very important for evaluating the messages. Time information is only added to the messages at the SYSLOG client in order not to disturb their chronological consistency due to different device times.

 The LANCOM devices must have a valid time stamp for the evaluation of the SYSLOG messages in internal memory.

## Contents

The actual contents of the SYSLOG messages describe the event, for example a login occurrence, the establishment of a WAN connection, or firewall activities.

### 5.3.3 Configuring SYSLOG using LANconfig

You can find the parameters to configure SYSLOG under LANconfig in the configuration area "Log & Trace" on the "SYSLOG" tab.

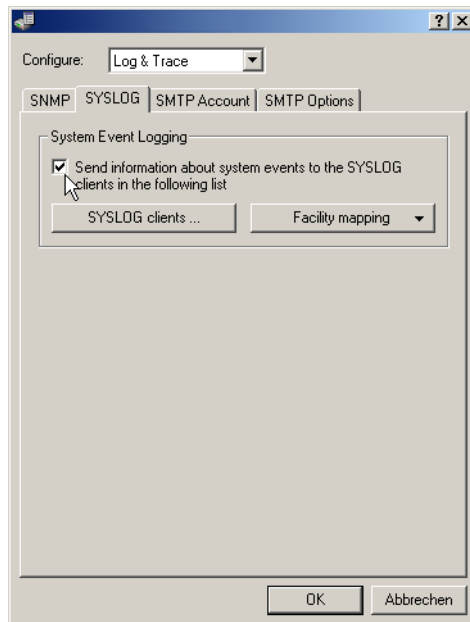

#### Creating SYSLOG clients

When setting up a SYSLOG client, first define the IP address to which SYSLOG messages are to be sent. As an option, you can define a different sending IP address. To do this, select which of the internal LANCOM sources are to send messages to this SYSLOG client. You can further restrict the volume of messages by selecting certain priorities, for example only alarm and error messages.

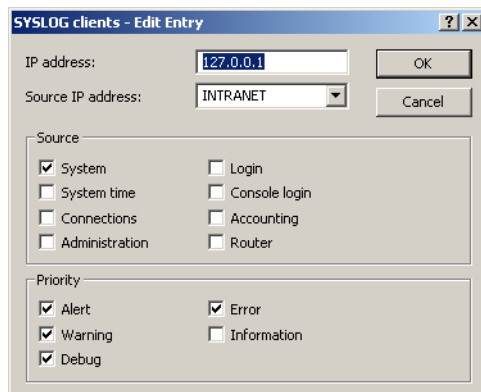

As of LCOS version 7.6 the table of syslog clients (factory settings) is set up to display important events which are relevant to diagnostics, and to save these to the internal syslog memory. The following screenshot shows these pre-defined syslog clients under LANconfig:

IP address	Source addr.	System	Login	System time	Console login	Connections	Accounting	Administration	Router	Alert	Error	Warning	Information	Debug
127.0.0.1	INTRANET	Off	Off	On	Off	Off	Off	Off	Off	On	On	Off	Off	Off
127.0.0.1	INTRANET	On	Off	Off	Off	Off	Off	Off	Off	On	On	On	Off	On
127.0.0.1	INTRANET	Off	Off	Off	Off	On	Off	Off	Off	On	On	Off	Off	Off
127.0.0.1	INTRANET	Off	Off	Off	Off	Off	Off	On	Off	On	On	Off	On	Off
127.0.0.1	INTRANET	Off	On	Off	Off	Off	Off	Off	Off	On	On	Off	On	Off
127.0.0.1	INTRANET	Off	Off	Off	On	Off	Off	Off	Off	On	On	Off	On	Off
127.0.0.1	INTRANET	Off	Off	Off	Off	Off	On	Off	Off	On	On	Off	On	Off
127.0.0.1	INTRANET	Off	Off	Off	Off	Off	Off	Off	Off	On	On	Off	On	Off

! Further information about the meaning of the pre-defined syslog clients and the update options for existing LANCOM devices are to be found in the section "Table of syslog clients" for the configuration of syslog via telnet or WEBconfig.

### Assigning internal LANCOM sources to SYSLOG facilities

The SYSLOG protocol uses certain designations for message sources, the so-called facilities. Each internal source in the LANCOM devices that can generate a SYSLOG message must therefore be assigned to a SYSLOG facility.

The standard mapping can be changed, if necessary. So, for example, all SYSLOG messages from a LANCOM can be sent with a certain facility (Local7). It is thus possible to collect all LANCOM messages in a common log file by configuring the SYSLOG client appropriately.

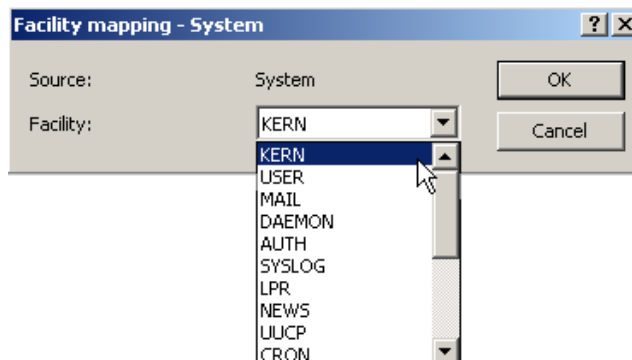

### 5.3.4 Configuring SYSLOG using Telnet or WEBconfig

Path: Setup/SYSLOG

- Active
  - Activates the dispatch of information about system events to the configured SYSLOG client.
- Port
  - Port used for sending SYSLOG messages.

#### Facility mapping

Path: Setup/SYSLOG/Facility-Mapper

- Facility
  - Mapping sources to specific facilities.
- Source
  - Mapping sources to specific facilities.

## Table of SYSLOG clients

As of LCOS version 7.6 the table of syslog clients (factory settings) is set up to display important events which are relevant to diagnostics, and to save these to the internal syslog memory. The following screenshot shows these pre-defined syslog clients under WEBconfig:

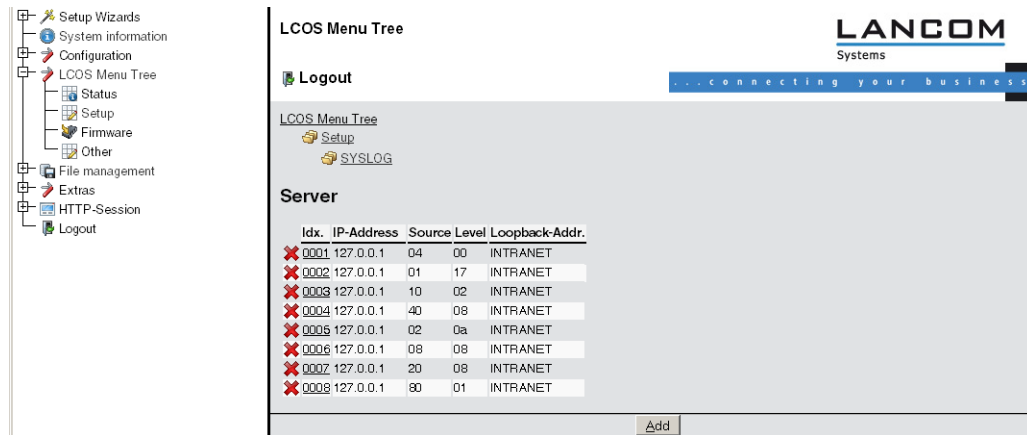

WEBconfig: LCOS menu tree/ Setup/ SYSLOG/ SYSLOG table

All pre-defined syslog clients transmit the messages to the IP address 127.0.0.1, i.e. to the LANCOM itself. The sender IP address is the IP address from the "INTRANET" network. Individual entries have the following functions:

Index	Source	Level	Meaning
0001	04	00	System time without a specified level
0002	01	17	System messages with the level alarm, error, alert or debug.
0003	10	02	Connection messages with the level error.
0004	40	08	Management messages with the level information.
0005	02	0a	Logins with the level error or information.
0006	08	08	Console logins with the level information.
0007	20	08	Accounting messages with the level information.
0008	80	01	Router messages with the level alarm.

! If you update an existing device, the settings for SYSLOG are **not** set to this default value, so that any existing settings are retained. In this case you can enter the settings according to this table. Alternatively you will find a script for automatically installing pre-defined syslog clients on the LANCOM Web site in the "KnowledgeBase".

- Idx.  
Position of the entry in the table.
- IP address  
IP address of the SYSLOG client.
- Source  
Source that caused the message to be sent. Each source is represented by a certain code.
- Level  
SYSLOG level with which the message is sent. Each level is represented by a certain code.
- Loopback address

This is where you can configure an optional sender address for use instead of that automatically selected for the destination address.

### 5.3.5 Addition(s) to LCOS 8.80

#### Configuring SYSLOG using LANconfig

For configuration with LANconfig, the SYSLOG module is located under the configuration section **Log & Trace > General** on the **SYSLOG** pane.

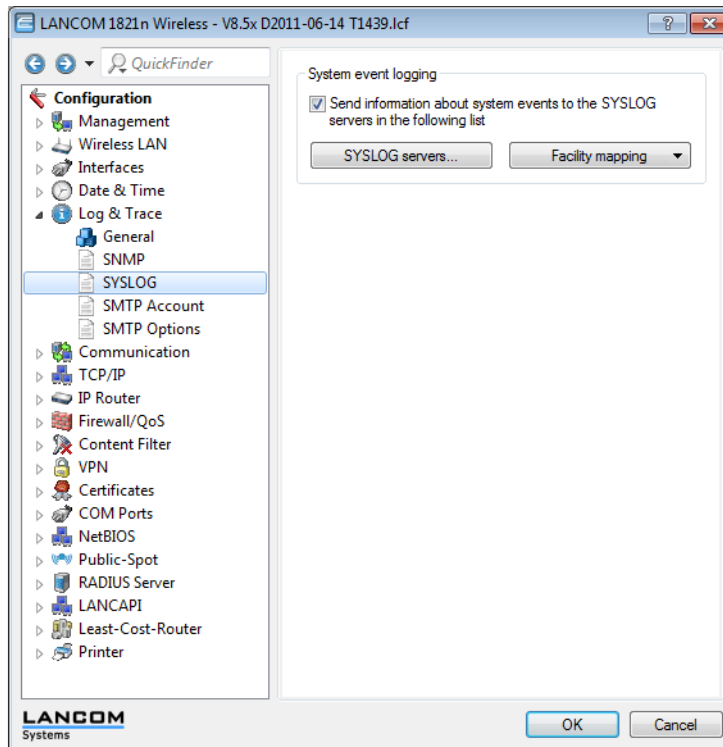

#### Creating SYSLOG clients

When setting up a SYSLOG client, you first define the IP address to which the SYSLOG server is to send the messages. Do this in the LANconfig configuration by clicking on **Log & Trace > General**, then in the **SYSLOG** pane click on **SYSLOG servers**, and then click **Add** or **Edit**. Set the IP address and optionally specify a different source IP address. To do this, select which of the internal LANCOM sources are to send messages to this SYSLOG client. You can further restrict the volume of messages by selecting certain priorities, for example only alarm and error messages.

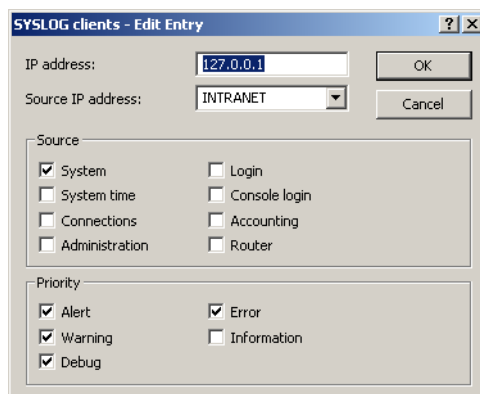



With the factory settings, the table of SYSLOG clients is set up to display important events which are relevant to diagnostics, and to save these to the internal SYSLOG memory. The following screenshot shows these pre-defined SYSLOG clients under LANconfig:

IP address	Source addr.	System	Login	Syst...	Consol...	Con...	Acc...	Adminis...	Router	Alert	Error	Warning
127.0.0.1	INTRANET	Off	Off	On	Off	Off	Off	Off	Off	Off	Off	Off
127.0.0.1	INTRANET	On	Off	Off	Off	Off	Off	Off	Off	On	On	On
127.0.0.1	INTRANET	Off	Off	Off	Off	On	Off	Off	Off	Off	On	Off
127.0.0.1	INTRANET	Off	Off	Off	Off	Off	Off	On	Off	Off	Off	Off
127.0.0.1	INTRANET	Off	On	Off	Off	Off	Off	Off	Off	Off	On	Off
127.0.0.1	INTRANET	Off	Off	Off	On	Off	Off	Off	Off	Off	Off	Off

! Further information about the meaning of the pre-defined SYSLOG clients and the update options for existing LANCOM devices are to be found in the section "Table of SYSLOG clients" for the configuration of SYSLOG via telnet or WEBconfig.

### Assigning internal LANCOM sources to SYSLOG facilities

The SYSLOG protocol uses certain designations for message sources, the so-called facilities. Each internal source in the LANCOM devices that can generate a SYSLOG message must therefore be assigned to a SYSLOG facility.

The standard mapping can be changed, if necessary. In this way you can, for example, send all SYSLOG messages from a LANCOM with a specific facility (Local7). It is thus possible to collect all LANCOM messages in a common log file by configuring the SYSLOG client appropriately.

Under **Log & Trace > General** in the section **SYSLOG** under **Facility mapping**, the internal LANCOM sources can be assigned to the corresponding SYSLOG facilities.

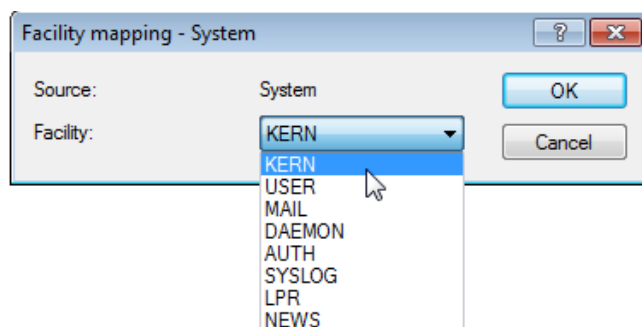

## 5.3.6 Addition(s) to LCOS 8.82

### SYSLOG: Configuration of the retention period for system events

As of Version LCOS 8.82 you can also enter the retention period for system events in hours, days, and months.

#### Additions to the Setup menu

##### Message age unit

This parameter determines whether the message age is specified in hours, days and months.

! In this case, a month is 30 days.

##### SNMP ID:

2.22.11

**Telnet path:****Setup > SYSLOG****Possible values:**

Hour

Day

Month

**Default:**

Hour

**Enhancements to LANconfig****Configuration of the retention period for system events**

Under **log & Trace > System events** you can specify how long the device should save system events in the section **System event logging**. You can specify both the quantity (0-9999) and the unit (hour, day, month).

! In this case, a month is 30 days.

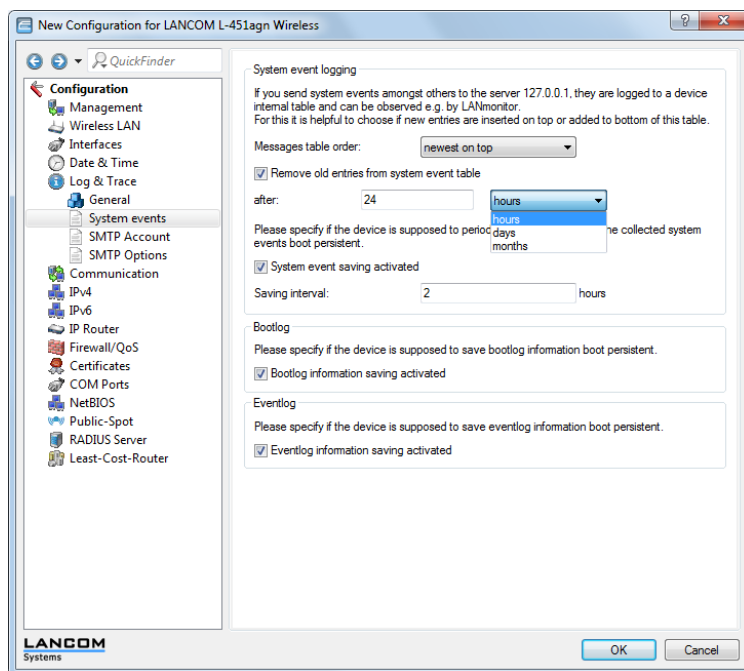
**SYSLOG: Extension of log entries of the internal SYSLOG server**

As of LCOS version 8.82, the internal syslog server for certain devices can store up to 23,000 entries.

This change currently applies to the following device types and series:

- LANCOM 17xx+ series
- LANCOM 1781 series
- LANCOM 1780EW-4G
- LANCOM L-460agn dual Wireless
- LANCOM L-451agn Wireless
- LANCOM L-452agn dual Wireless

- LANCOM 7100+ VPN
- LANCOM 9100+ VPN
- LANCOM WLC-4006+

### SYSLOG: Extended status display of the login to the cellular network

As of LCOS version 8.82, the SYSLOG displays detailed information about the status of the login process on a cellular network (UMTS/3G+, GPRS, LTE/4G).

#### Extended status display of the login to the cellular network

In order to more quickly analyze connection problems in a cellular network, WWAN-capable LANCOM routers report all logon procedures to the SYSLOG. In this manner, the user can recognize if and why the cellular service provider rejected the connection, for example.

The device generates a SYSLOG entry for each of the following events:

#### Modification or problem when setting the registration status

Status	Meaning	SYSLOG severity
not searching for network	The modem is not registered and is not searching for a cellular network.	INFORM
searching for network	The modem is not registered and is not searching for a cellular network.	INFORM
registered to home network	The modem has registered on its service provider's cellular network.	INFORM
registered to foreign network	The modem has successfully registered on the cellular network of the service provider's roaming partner.	INFORM
unknown registration	Initial value. The modem has not yet received a response from the radio module regarding the registration status.	INFORM
network registration denied	The cellular service provider has rejected the login on the cellular network.	ERROR
lost network registration	The modem lost the connection to the registered cellular network.	NOTICE
failed to set network	The modem has replied to the command to assign the network with an error message. This error occurs if, for example, the network cannot be reached or does not exist, or an error has occurred on the device.	ERROR
failed to set network mode	The modem has replied to the command to assign the network mode with an error message. This error occurs if, for example, the network cannot be reached or does not exist, or an error has occurred on the device.	ERROR

#### Problem when setting the network mode

Status	SYSLOG severity
Auto	ERROR

Status	SYSLOG severity
UMTS	ERROR
GPRS	ERROR
LTE	ERROR

### Problem when setting the APN

Status	Meaning	SYSLOG severity
Invalid APN	An invalid APN was selected for the SIM or the cellular network.	ERROR
failed to set APN	The modem has replied to the command to assign the APNs with an error message. This error occurs if, for example, the network cannot be reached or does not exist, or an error has occurred on the device.	ERROR

### Additions to the Status menu

#### Network registration

This entry shows the status value of the network registration. Every status change generates an SNMP trap message for subsequent evaluation and processing (e.g., by an SNMP manager).

Possible values include:

- **No\_Network:** The modem is not registered and is not searching for a cellular network.
- **Home\_Network:** The modem has registered on its service provider's cellular network.
- **Searching:** The modem is not registered and is not searching for a cellular network.
- **Searching(Denied):** The modem is not registered and is searching for a network, but was rejected at least once during the search. This addition disappears as soon as the modem successfully registers.
- **Unknown:** Initial value. The modem has not yet received a response from the radio module regarding the registration status.
- **Roaming:** The modem has successfully registered on the cellular network of the service provider's roaming partner.
- **Denied:** The cellular service provider has rejected the login on the cellular network.

#### SNMP ID:

1.49.7

#### Telnet path:

**Status > Modem-Cellular-Network**

## 5.4 The ping command

With the ping command in Telnet or in a terminal connection an „ICMP Echo Request“ is sent to the addressed host. As long as the recipient provides the protocol and the request is not filtered by the firewall, the addressed host answers with an „ICMP Echo Reply“. In case the host is not available, the last router before the host answers with „Network unreachable“ or „Host unreachable“.

The syntax of the ping commando is:

- `ping [-fnqr] [-s n] [-i n] [-c n] [-a a.b.c.d] hostaddress`

The meaning of the optional parameters are listed in the following table:

Parameter	Meaning
-a a.b.c.d	Sets the sender address of the ping (standard: IP Adresse of the router)
-a INT	Sets the intranet address of the router as sender address
-a DMZ	Sets the DMZ address of the router as sender address
- a LBx	Sets one of the 16 Lancom Loopback addresses as sender address. Valid for x are the hexadecimal values 0-f
-f	flood ping: Sends many ping signals in a small amount of time. Can be used e. g. to test the broadband of the network. ATTENTION: flood ping can easily be interpreted as a DoS attack.
-n	Sends the computer name back zu the given IP address
-q	Ping command does not give an output on the panel
-r	Change to traceroute mode: every interstation passed by the data package is listed
-s n	Sets the package size to n Byte (max. 1472)
-i n	Time between the packages in seconds
-c n	Send n ping signals
hostaddress	Address or hostname of the recipient
stop /<RETURN>	Entering "stop" or pressing the RETURN button terminates the ping command

```

192.168.2.100 - PuTTY
root@VPN_NHAMEL:/
> ping -a 192.168.2.50 -c 217.160.175.241
': Syntax error

root@VPN_NHAMEL:/
> ping -a 192.168.2.50 -c 2 217.160.175.241

56 Byte Packet from 217.160.175.241 seq.no=0 time=53.556 ms

---217.160.175.241 ping statistic---
56 Bytes Data, 1 packets transmitted, 1 packets received, 0% loss

root@VPN_NHAMEL:/
> ping -n -c 1 217.160.175.241
p15125178.pureserver.info
56 Byte Packet from 217.160.175.241 seq.no=0 time=53.279 ms

---217.160.175.241 ping statistic---
56 Bytes Data, 1 packets transmitted, 1 packets received, 0% loss

root@VPN_NHAMEL:/
> ping -f www.lancom.de

1 Traceroute 217.5.98.182 seq.no=0 time=47.961 ms
2 Traceroute 217.237.154.146 seq.no=1 time=44.962 ms
3 Traceroute 62.154.46.182 seq.no=2 time=55.810 ms
4 Traceroute 194.140.114.121 seq.no=3 time=56.797 ms
5 Traceroute 194.140.115.244 seq.no=4 time=71.948 ms
6 Traceroute 212.99.215.81 seq.no=5 time=78.293 ms
7 Traceroute 213.217.69.77 seq.no=6 time=82.287 ms
 Traceroute 213.217.69.69 seq.no=7 time=79.340 ms

---213.217.69.69 ping statistic---
56 Bytes Data, 8 packets transmitted, 8 packets received, 0% loss

root@VPN_NHAMEL:/
>

```

## 5.5 Monitoring the switch

The data transmission over the switch of LANCOM devices only takes place on the port the target computer is attached to. Therefore the connections on the other ports are not visible.

For monitoring data traffic between ports, the ports must be set to monitor mode. In this state all data is issued, that is transmitted over the switch of the devices between stations of the LAN and WAN.

For the configuration with LANconfig open the Ethernet switch settings in the configuration area 'Interfaces' on the register 'LAN' with the button **Ethernet Ports**.

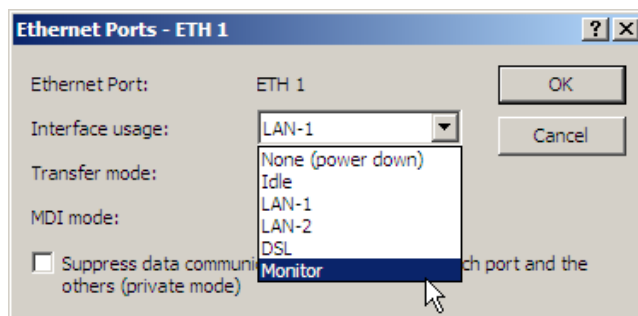

WEBconfig: LCOS menu tree / Setup / Interfaces / Ethernet-Ports.

## 5.6 Cable testing

A cabling defect might have occurred, if no data is transmitted over LAN or WAN connection, although the configuration of the devices does not show any discernible errors.

You can test the cabling with the built-in cable tester of your LANCOM. Change under WEBconfig to menu item **LCOS menu tree / Status / Ethernet-Ports / Cable test**. Enter here the name of the interface to be tested (e.g. "DSL1" or

“LAN-1”). Pay attention to the correct spelling of the interfaces. Start the test for the specified interface by clicking on **Execute**.

The screenshot shows the LANCOM Systems web interface. On the left is a navigation menu with 'Ethernet-Ports' selected under 'LCOS Menu Tree'. The main content area is titled 'Cable-Test' and contains a text input field for 'Arguments' with the value 'ETH-2'. Below the input field are 'Execute' and 'Reset' buttons.

Change then to menu item **LCOS menu tree / Status / Ethernet-Ports / Cable test results**. The results of the cable test for the individual interfaces are show up in a list.

The screenshot shows the LANCOM Systems web interface displaying the 'Cable-Test-Results' page. The left sidebar shows 'Cable-Test-Results' selected. The main content area displays a table with the following data:

Ifc	Tx-Status	Tx-Distance	Rx-Status	Rx-Distance
ETH-1	OK		OK	
ETH-2	unknown		unknown	
ETH-3	unknown		unknown	
ETH-4	unknown		unknown	

Below the table are 'Update' and 'Monitor this Table' buttons, and an 'Update Interval (s):' field set to 5.

The following results can occur:

- **OK**: Cable plugged in correctly, line ok.
- **open** with distance "0m": No cable plugged in or interruption within less than 10 meters distance.
- **open** with indication of distance: Cable is plugged in, but defect at the indicated distance.
- **Impedance error**: The pair of cables is not terminated with the correct impedance at the other end.

## 5.7 Addition(s) to LCOS 8.80

### 5.7.1 Trace output for the XML interface

As of LCOS version 8.80, you can use the command `trace # XML-Interface-PbSpot` to activate a trace that verifies whether XML requests were successful or error messages were received.

This parameter ...	...causes the following message in the trace:
XML-Interface-PbSpot	Messages from the Public Spot XML interface

## 5.7.2 Packet capturing

In order to capture packets for the analysis of errors or problems, the command line tool **lcoscap** has been made available as of LCOS version 8.60. This command enables the capture of packets and writes the results to a file that you can open and analyze using a tool like Wireshark.

With LCOS version 8.80 an additional and more convenient method has been introduced: A new menu in WEBconfig allows you to set various parameters and capture data packets from selected interfaces, which can then be analyzed in a results file.

This method offers you several advantages:

- You do not need any special software, because you can run WEBconfig on any Web browser.
- There is no need to input any CLI commands. Instead, you work with a convenient menu.
- If you use WEBconfig over HTTPS, the confidentiality and security of captured traffic is guaranteed.

The new feature is to be found under **Extras > Packet capture**. After you set the parameters and click on **Go!** you create a file that you can save anywhere and open with Wireshark, for example.

### Enhancements to WEBconfig

#### Packet capturing

The **Extras > Packet capture** function offers you a simple way to record data packets from different interfaces and then analyze them. Note that the possible settings can vary depending on the device type. You have more settings for WLAN devices than for devices without WLAN functionality.

The figure below shows the dialog for a WLAN device. In this case, there are two additional, WLAN-specific parameters.

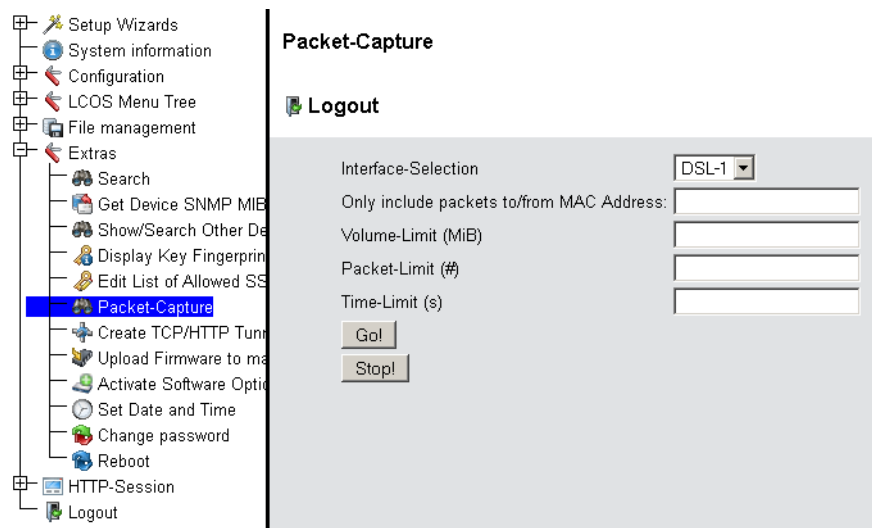

To specify the output file the following general menu items are available:

- **Interface selection:** Use this drop-down menu to choose the interface that you want to record data packets for.
- **Only include packets to/from MAC address:** If you only want to record data packets for a particular physical address within the selected interface, you can specify it here.
- **Volume limit (MiB):** Enter the maximum volume of the recorded packages in Megabytes.
- **Packet limit (#):** Here you can set the maximum number of packages to be recorded.
- **Time limit (s):** Enter the maximum time in seconds, after which the recording ends.



Click on **Go!** to start the recording process. After a certain period of time (depending on the connection speed), a window opens for you to save the generated files. You can now save the file locally with the suffix `.cap`. By default, the file name is composed of the description and interface associated with the device for which the data packets were recorded (e.g. `LCWLC-4025-LAN-2.cap`). You can change the name when saving or later.

You can stop a recording at any time by clicking on **Stop!**. This can be useful, for example, if you want to correct or customize the parameters that you already entered.



If you start recording without setting any limits, the device keeps recording the packets until you manually stop the process by clicking on **Stop**.

## 6 Security

You certainly would not like any outsider to have easy access to or to be able to modify the data on your computer. Therefore this chapter covers an important topic: safety. The description of the security settings is divided into the following sections:

- Protection for the configuration
  - Password protection
  - Login barring
  - Access verification
- Securing ISDN access

At the end of the chapter you will find the most important security settings as a checklist. It ensures that your LANCOM is excellently protected.

---

 Some further LCOS features to enhance the data security are described in separate chapters:

### 6.1 Protection for the configuration

A number of important parameters for the exchange of data are established in the configuration of the device. These include the security of your network, monitoring of costs and the authorizations for the individual network users.

Needless to say, the parameters that you have set should not be modified by unauthorized persons. The LANCOM thus offers a variety of options to protect the configuration.

#### 6.1.1 Password protection

The simplest option for the protection of the configuration is the establishment of a password.

---

 As long as a password hasn't been set, anyone can change the configuration of the device. For example, your Internet account information could be stolen, or the device could be reconfigured in a way that the protection-mechanisms could be bypassed.

---

 Note: If a password has not been set, the Power LED flashes, until the devices have been configured correctly.

#### Tips for proper use of passwords

We would like to give you a few tips here for using passwords:

- **Keep a password as secret as possible.** Never write down a password. For example, the following are popular but completely unsuitable: Notebooks, wallets and text files in computers. It sounds trivial, but it can't be repeated often enough: don't tell anyone your password. The most secure systems surrender to talkativeness.
- **Only transmit passwords in a secure manner.** A selected password must be reported to the other side. To do this, select the most secure method possible. Avoid: Non-secure e-mail, letter, or fax. Informing people one-on-one is preferable. The maximum security is achieved when you personally enter the password at both ends.
- **Select a secure password.** Use random strings of letters and numbers. Passwords from common language usage are not secure. Special characters such as '&"?#-\*+\_;!°' make it difficult for potential attackers to guess your password and increase the security of the password.

 Capital and small letters are distinguished in the configuration password.

- **Never use a password twice.** If you use the same password for several purposes, you reduce its security effect. If the other end is not secure, you also endanger all other connections for which you use this password at once.
- **Change the password regularly.** Passwords should be changed as frequently as possible. This requires effort, however considerably increases the security of the password.
- **Change the password immediately if you suspect someone else knows it.** If an employee with access to a password leaves the company, it is high time to change this password. A password should also always be changed when there is the slightest suspicion of a leak.

If you comply with these simple rules, you will achieve the highest possible degree of security.

### Entering the password

You will find the box to enter the password in LANconfig in the configuration area 'Management' on the 'Admin' tab. Under WEBconfig you run the wizard Security Settings. In a terminal or Telnet session you set or change the password with the command `passwd`.

LANconfig: Management / Admin / Password

WEBconfig: Tool / Change password

### Protecting the SNMP access

At the same time you should also protect the SNMP read access with a password. For SNMP the general configuration password is used.

LANconfig: Management / Admin / Password required for SNMP read permission

WEBconfig: LCOS menu tree / Setup / SNMP E Password- required-for-SNMP-read-access

## 6.1.2 Login barring

The configuration in the LANCOM is protected against "brute force attacks" by barring logins. A brute-force attack is the attempt by an unauthorized person to crack a password to gain access to a network, a computer or another device. To achieve this, a computer can, for example, go through all the possible combinations of letters and numbers until the right password is found.

As a measure of protection against such attacks, the maximum allowed number of unsuccessful attempts to login can be set. If this limit is reached, access will be barred for a certain length of time.

If barring is activated on one port all other ports are automatically barred too.

The following entries are available in the configuration tools to configure login barring:

- Lock configuration after (`Login-errors`)
- Lock configuration for (`Lock-minutes`)

LANconfig: Management / Admin

WEBconfig: LCOS menu tree / Setup / Config

## 6.1.3 Restriction of the access rights on the configuration

Access to the internal functions of the devices can be restricted separately for each access method as follows:

- ISDN administrative account
- LAN
- Wireless LAN (WLAN)
- WAN e.g. ISDN, DSL or ADSL

For network-based configuration access further restrictions can be made, e.g. that solely specified IP addresses or dedicated LANCAPI clients are allowed to do so. Additionally, all following internal functions are separately selectable.

- LANconfig (TFTP)
- WEBconfig (HTTP, HTTPS)
- SNMP
- Terminal/Telnet

! The use of the internal functions with a WAN interface of devices with VPN can be restricted merely for the VPN connection.

### Restrictions on the ISDN administrative account

As long as no MSN-configuration is entered a non-configured LANCOM accepts the calls on all MSNs. As soon as the first change in the configuration ist saved the device only accepts calls on the configuration MSN.

! If no configuration MSN ist entered when configuring the first time, the remote configuration ist switched off and the device ist protected from the access over the ISDN line.

1. Change to the register card 'Admin' in the 'Management' configuration area:

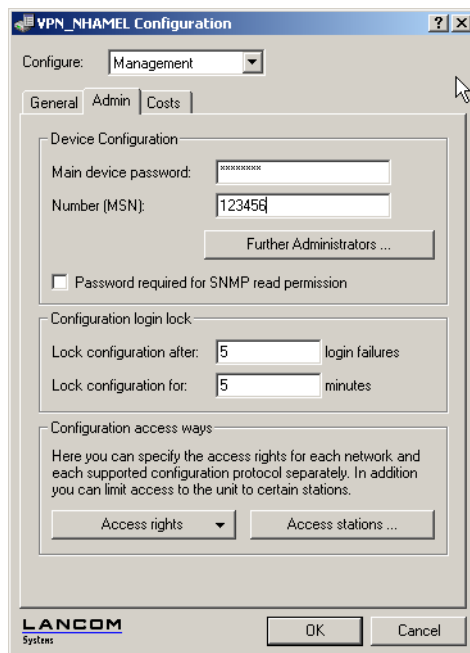

1. Enter as call number within 'Device configuration' a call number of your connection, which is not used for other purposes.

Enter alternatively the following instruction:

```
set /setup/config/farconfig-(EAZ-MSN) 123456
```

! The ISDN administrative account is excluded as only configuration method from in the following described restrictions of network access methods. I.e. all on the Admin MSN incoming connections are not limited by the access restrictions of remote networks.

! If you want to completely switch off the ISDN remote management, leave the field with Admin MSN empty.

## Limit the network configuration access

The access to the internal functions can be controlled separately for accesses from the local or from remote networks - for all configuration services separately. The configuration access can generally be permitted or forbidden, a pure read access or - if your model is equipped with VPN - also can be permitted only over VPN. You can open the configuration dialogue with the access rights from the local or from remote networks over the button access rights:

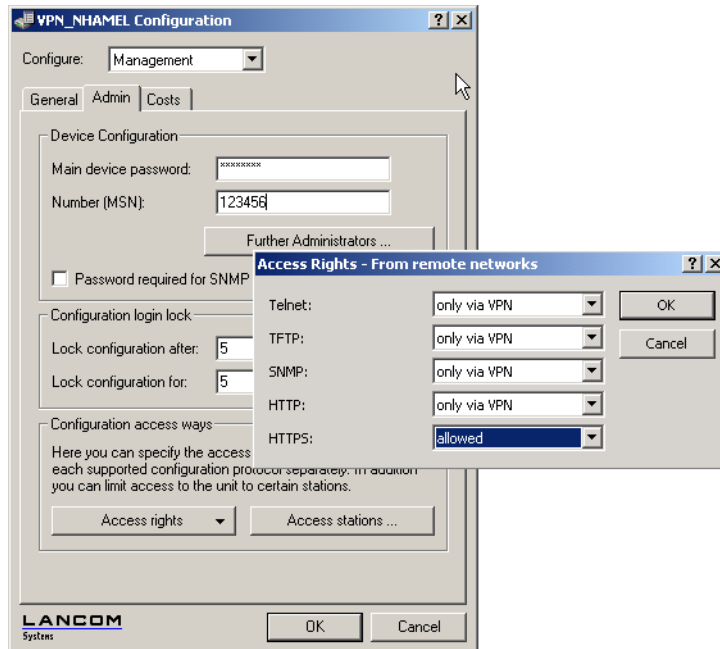

! If you want to remove the network access to the router over the WAN completely, set the configuration access from distant nets for all methods to 'denied'.

LANconfig: Management / Admin / access rights

WEBconfig: LCOS menu tree / Setup / Config / Access-list

## Restriction of the network configuration access to certain IP addresses

With a special filter list the access to the internal functions of the devices can be limited to certain IP addresses. The configuration dialog with the access rights from local or distant networks can be opened with the Button **Access stations**.

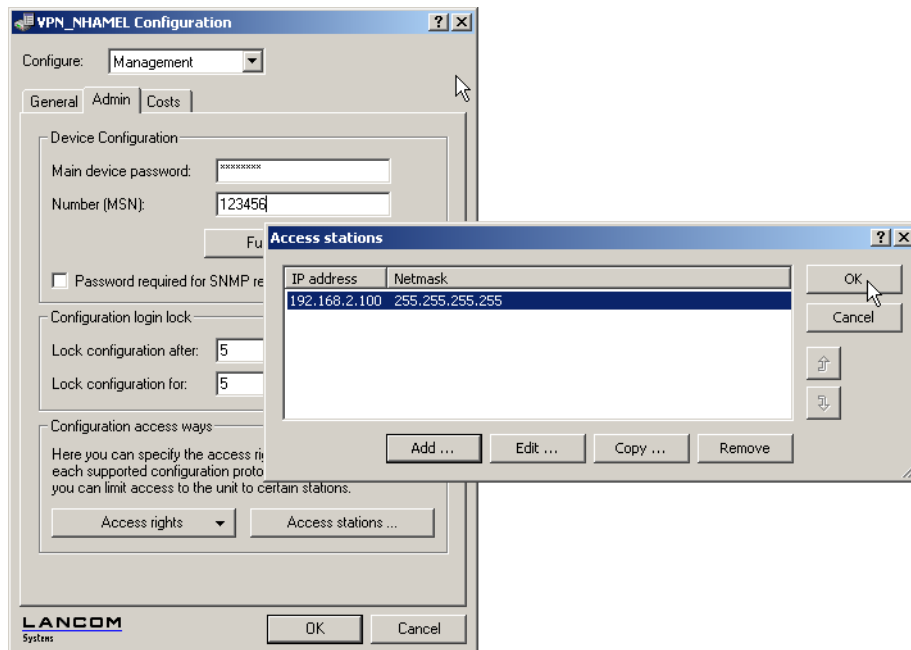

By default, this table does not contain entries. Thus the device can be accessed over TCP/IP from computers with arbitrary IP addresses. With the first entry of a IP address (as well as the associated net mask) the filter is activated, and solely the IP addresses contained in this entry are entitled to use the internal functions then. With further entries, the number of the entitled ones can be extended. The filter entries can designate both individual computers and whole networks.

With WEBconfig for Telnet you reach the configuration of the access list with the following runs:

LANconfig: Management / Admin / access stations

WEBconfig: LCOS menu tree / Setup / TCP-IP / Access-list

## 6.2 Protecting the ISDN connection

For a device with an ISDN connection basically any ISDN subscriber can dial into your LANCOM. To prevent undesired intruders, you must therefore pay particular attention to the protection of the ISDN connection.

The protection functions of the ISDN connection can be divided into two groups:

- Identification control
  - Access protection using name and password
  - Access protection via caller ID
- Callback to defined call numbers

### 6.2.1 Identification control

For identification monitoring either the name of the remote site or the so-called caller ID can be used. The caller ID is the telephone number of the caller that is normally transmitted to the remote site with the call with ISDN.

Which "Identifier" is to be used to identify the caller is set in the following list:

LANconfig: Communication / Call Management

WEBconfig: LCOS menu tree / Setup / WAN / Protect

You have a choice of the following:

- all: Calls are accepted from any remote station.
- by number: Only calls from those remote stations whose Calling Line Identification number (CLIP) is entered in the number list are accepted.
- by approved number: Only calls from those remote stations whose Calling Line Identification number (CLIP) is entered in the peer list **and** whose number is approved by the Central Office.

It is an obvious requirement for identification that the corresponding information is sent by the caller.

### Verification of name and password

In the case of PPP, a user name (and in conjunction with PAP, CHAP or MS-CHAP, a password) is sent to the remote station during connection establishment. When a computer dials into the LANCOM, the communications software, for example Windows Dial-Up Network, prompts the user for the user name and password to be transferred.

If the router establishes the connection itself, for instance, to an ISP, it is using the user name and password from the PPP list. If no user name is listed there, the device name is used in its place.

The PPP list can be found as follows:

LANconfig: Communication / Protocols / PPP list

WEBconfig: LCOS menu tree / Setup / WAN / PPP-list

In addition, the PPP protocol also permits the caller to require an authentication from the remote station. The caller then requests a user or device name and password from the remote station.

---

 Of course you will not need to use the PAP, CHAP or MS CHAP security procedures if you are using the LANCOM to dial up an Internet service provider yourself, for example. You will probably not be able to persuade the ISP to respond to a request for a password...

### Checking the number

When a call is placed over an ISDN line, the caller's number is normally sent over the D channel before a connection is even made (CLI – Calling Line **I**dentifier).

Access to your own network is granted if the call number appears in the number list, or the caller is called back if the callback option is activated. If the LANCOM is set to provide security using the telephone number, any calls from remote stations with unknown numbers are denied access.

You can use call numbers as a security measure with any B-channel protocol (layers).

## 6.2.2 Callback

The callback function offers a special form of access privilege: This requires the 'Callback' option to be activated in the peer list for the desired caller and the call number to be specified, if required.

LANconfig: Communications / Remote site / Remote Sites (ISDN/serial)

WEBconfig: LCOS menu tree / Setup / WAN / dialup-peers

Using the settings in the name and number list and the selection of the protocol (LANCOM or PPP), you can control the callback behaviour of your router :

- The router can refuse to call back.
- It can call back using a preset call number.
- First the name can be checked and then a preset telephone number can be called back.
- The caller can opt to specify the call number to be used for callback.

And all the while you can use the settings to dictate how the cost of the connection is to be apportioned. The router accepts all unit charges, except for the unit required to send the name, if call back 'With name' is set in the peer list. The caller also accepts a unit if the caller is not identified via CLIP (Calling Line Identifier Protocol). On the other hand, the caller incurs no costs if identification of the caller's number is possible and is accepted (callback via the D channel).

An especially effective callback method is the fast-callback procedure (patent pending). This speeds up the callback procedure considerably. The procedure only works if it is supported by both stations. All current LANCOM routers are capable of fast callback.



Additional information on callback can be found in section .

## 6.3 Location verification by ISDN or GPS

After being stolen, the device can theoretically be operated at another location by unauthorized persons. Password-protected device configurations offer no protection from the operation of the RAS access, LAN coupling or VPN connections that are set up in the device; a thief could gain access to a protected network.

The device's operation can be protected by various means; for example, it will cease to function if there is an interruption to the power supply, or if the device is switched on in another location.

### 6.3.1 GPS location verification

GPS location verification enables a geographical position to be defined within the device. After being switched on the device automatically activates the GPS module and checks if it is located at the "correct" position. The router module is only switched on if the check is positive. After location verification has been carried out the GPS module is deactivated again, unless it was switched on manually.

### 6.3.2 ISDN location verification

ISDN location verification can prevent the misuse of a router. Each time it is switched on, the router carries out a check by making an ISDN telephone call to itself to ensure that it is installed at the intended location. Only after successful location verification is the router module activated.

Prerequisites for successful ISDN location verification:

- The device must be reachable from the public ISDN telephone network.
- The device needs two free B channels for the duration of the check. If just one channel is free, e.g. one channel at a point-to-multipoint connection with two B channels is being used for a telephone call, then the device cannot make a call to itself via ISDN.

### 6.3.3 Configuring location verification

Parameters for location verification are to be found in LANconfig in the configuration area 'Management' on the 'Location' tab.



- ! You can enable the GPS module on the 'GPS' tab independently from the location verification e. g. for monitoring the current GPS coordinates using LANmonitor.

- Activate location verification with the 'Enable location check' option.
- Select the method for the location check:
  - 'Self call' for a check via ISDN by means of a return call.
  - 'Call forwarding check' via ISDN by requesting the call number from the exchange. No call-back is necessary in this case.
  - 'GPS verification' for a check on the geographical coordinates.

! For a location check by GPS an appropriate GPS antenna must be connected to the AUX connector on the device. Additionally, a SIM card for mobile telephone operation has to be inserted and the device must be logged on to a mobile phone network.

- For the location check enter 'Self call' or 'Call forwarding check' and enter the destination number as the telephone number to be used for the check.
- For location verification by GPS enter the necessary parameters:
  - Degrees latitude and longitude
  - Deviation from the intended position in meters

! The device is itself able to determine the geographical coordinates for its current position by activating the 'Get reference coordinates via GPS' checkbox. Once the configuration is written back to the device, the current longitude and latitude are entered automatically, assuming that location verification is activated and a valid GPS position is available. Subsequently this option is automatically deactivated again.

As an alternative you can determine the geographical coordinates from tools such as Google Maps.

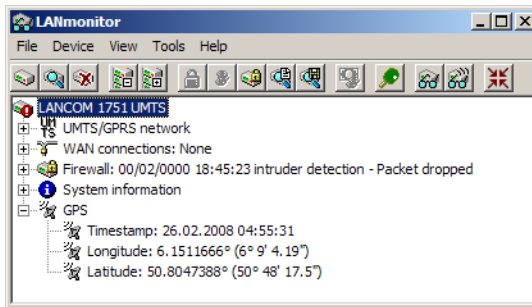

! When the current geographical coordinates are displayed in LANmonitor, you can right-click with the mouse on the entry 'GPS' to call up that location in Google maps.

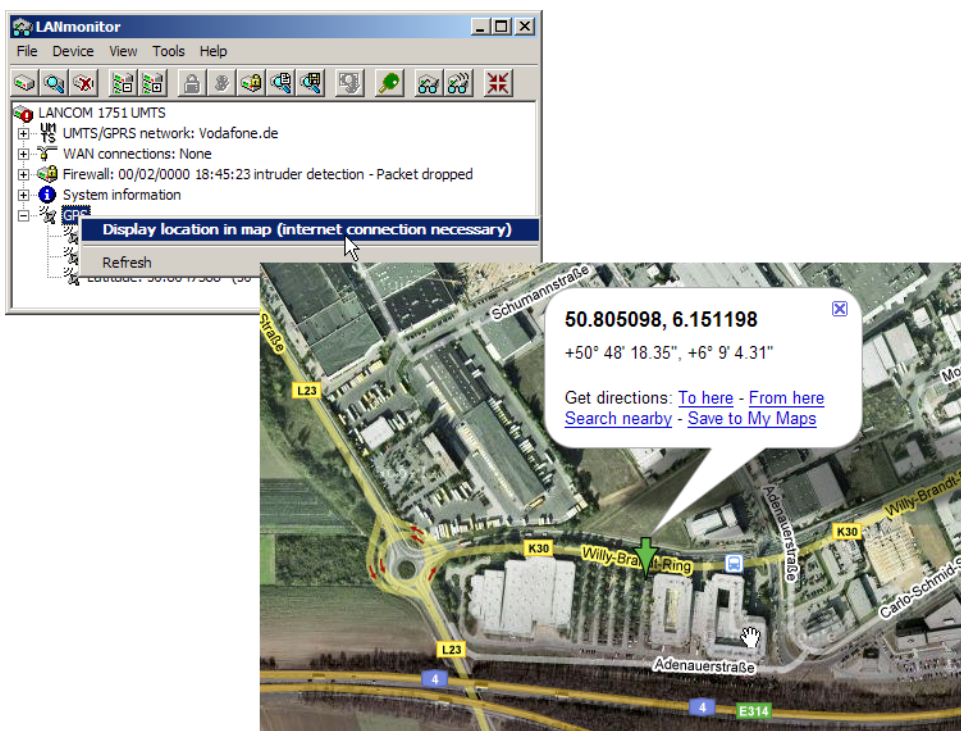

Under WEBconfig, Telnet or a terminal program, you will find the settings for location verification under the following paths:

LANconfig: communication / remote sites / remote sites (ISDN/serial)

WEBconfig: LCOS menu tree / Setup / Config / Location verification

The screenshot displays the LANCOM WEBconfig interface. On the left is a navigation tree with the following items: Setup Wizards, System information, Configuration, LCOS Menu Tree (expanded), Status, Setup, Firmware, Other, File management, Extras, HTTP-Session, and Logout. The main content area is titled 'LCOS Menu Tree' and includes a 'Logout' button, a 'LCOS Menu Tree' section with 'Setup' and 'Config' sub-items, and an 'Anti-Theft-Protection' section. The 'Anti-Theft-Protection' section contains the following settings:

Called-Number	0241520319
Checked-Calling-Number	
Enabled	No
ISDN-Ifc	S0-1
Method	Basic-Call
Outgoing-Calling-Number	

## Location verification status request

The status of location verification can be viewed under LANmonitor:

The screenshot shows the LANmonitor application window. The title bar reads 'LANmonitor'. The menu bar includes 'File', 'Device', 'View', 'Tools', and 'Help'. The main display area shows a tree view of system components with the following status:

- VPN\_INHAMEL
- WAN connections: 1
- VPN connections: 1
- Wireless LAN
- Firewall: 6/17/2005 13:40:33 DoS protection - Packet dropped
- System information
- Anti-theft protection: Successful

With WEBconfig (**LCOS menu tree / Status / Config / Location verification**) or Telnet (`Status/Config/Location verification`) you can view the status of the location verification:

### [Expert Configuration](#)

 [Status](#)

 [Config](#)

## Anti-Theft-Protection

State	Successfull
sending-call-to	
waiting-for-call-from	
last-seen-call-from	
call-accepted	No
incoming-call	No
last-error	
Method	GPS
Position-valid	Yes
Expected-Longitude[deg]	6.1518583
Current-Longitude[deg]	6.1518555
Expected-Latitude[deg]	50.8049638
Current-Latitude[deg]	50.8049638
Delta-Longitude[m]	1
Delta-Latitude[m]	0

Only when the location verification has the status 'Successful' will the router data be transferred over the WAN interfaces.

- Location verification via ISDN is successful when the number 'Expect call from' agrees with the number 'Last call from'. This call is not picked up by the router. The status also displays whether a call was accepted at all.
- Location verification via GPS is successful when the GPS position is valid and within the tolerated range deviation from the known position.

## 6.4 The security checklist

The following checklists provide an overview of all security settings that are important to professionals. Most of the points in this checklist are uncritical for simple configurations. In these cases, the security settings in the basic configuration or that were set with the Security Wizard are sufficient.

 Detailed information about the security settings mentioned here are to be found in the reference manual.

- Have you secured your wireless network with encryption and access control lists?

With the help of 802.11i, WPA or WEP, you can encrypt the data in your wireless network with different encryption methods such as AES, TKIP or WEP. LANCOM Systems recommends the strongest possible encryption with 802.11i and AES. If the WLAN client adapters do not support these, then you should use TKIP or at least WEP. Make sure that the encryption function in your device is activated, and that at least one passphrase or WEP key has been entered and selected for application.

- 
- ❗ For security reasons, LANCOM Systems strongly advises you not to use WEP! You should only ever use WEP under exceptional circumstances. When using WEP encryption, use additional security mechanisms additionally.

To check the WEP settings, open LANconfig, go to the configuration area and select 'WLAN security' on the '802.11i/WEP' tab to view the encryption settings for the logical and physical WLAN interfaces.

With the access control list (ACL) you can permit or prevent individual clients accessing your wireless LAN. The decision is based on the MAC address that is permanently programmed into wireless network adapters. To check the access-control list, go to the configuration area in LANconfig and select 'WLAN security' on the 'Stations' tab.

The LANCOM Enhanced Passphrase Security (LEPS) uses an additional column in the ACL to assign an individual passphrase consisting of any 4 to 64 ASCII characters to each MAC address. The connection to the access point and the subsequent encryption with IEEE 802.11i or WPA is only possible with the right combination of passphrase and MAC address.

- Have you protected the configuration with a password?

The simplest way of protecting the configuration is to agree upon a password. If no password has been agreed for the device, the configuration is open to be changed by anybody. The field for entering the password is to be found in LANconfig in the 'Management' configuration area on the 'Security' tab. It is absolutely imperative to assign a password to the configuration if you want to enable remote configuration!

- Have you permitted remote configuration?

If you do not require remote configuration, please ensure to switch it off. If you need to make use of remote configuration, ensure that you do not fail to password-protect the configuration (see the section above). The field for disabling remote configuration is to be found in LANconfig in the 'Management' configuration area on the 'Security' tab. Under 'Access rights – From remote networks' select the option 'denied' for all methods of configuration.

- Have you allowed configuration from the wireless LAN?

If you do not need to configure the device from the wireless LAN, switch this function off. The field for disabling configuration from the wireless LAN is to be found in LANconfig in the 'Management' configuration area on the 'Admin' tab. Under 'Access rights – From the wireless LAN' select the option 'denied' for all methods of configuration.

- Have your password-protected the SNMP configuration?

Protect the SNMP configuration with a password too. The field for password-protecting the SNMP configuration is also to be found in LANconfig in the 'Management' configuration area on the 'Security' tab.

- Have you activated the firewall?

The stateful inspection firewall of LANCOM devices ensures that your local network cannot be attacked from the outside. Activate the firewall in LANconfig under 'Firewall/QoS' on the 'General' tab.

- 
- ❗ Note that firewall security mechanisms (incl. IP masquerading, port filters, access lists) are active only for data connections that are transmitted via the IP router. Direct data connections via the bridge are not protected by the firewall!

- Are you using a 'deny all' firewall strategy?

Maximum security and control is initially achieved by denying all data traffic from passing the firewall. The only connections to be accepted by the firewall are those that are to be explicitly permitted. This ensures that Trojan horses and certain types of e-mail virus are denied communication to the outside. Activate the firewall rules in LANconfig under 'Firewall/QoS' on the 'Rules' tab. Instructions on this are to be found in the reference manual.

- Have you activated IP masquerading?

IP masquerading refers to the concealment of local computers while they access the Internet. All that is revealed to the Internet is the IP number of the router module of the device. The IP address can be fixed or dynamically assigned by the provider. The computers in the LAN then use the router as a gateway and are not visible themselves. The router separates the Internet from the intranet like a wall. The application of IP masquerading is set in the routing table for every route individually. The routing table can be found in the LANconfig in the configuration area 'IP router' on the 'Routing' tab.

- Have you used filters to close critical ports?

The firewall filters in LANCOM devices offer filter functions for individual computers or entire networks. It is possible to set up source and destination filters for individual ports or port ranges. Furthermore, filters can be set for individual protocols or any combination of protocols (TCP/UDP/ICMP). It is especially convenient to set up the filters with the aid of LANconfig. Under 'Firewall/QoS', the 'Rules' tab contains the functions for defining and editing filter rules.

- Have you excluded certain stations from accessing the device?

A special filter list can be used to limit access to the device's internal functions via TCP/IP. The phrase "internal functions" refers to configuration sessions via LANconfig, WEBconfig, Telnet or TFTP. As standard this table contains no entries, meaning that computers with any IP address can use TCP/IP and Telnet or TFTP to commence accessing the device. The first time an IP address is entered with its associated netmask, the filter is activated and only the IP addresses contained in this entry are entitled to make use of internal functions. Further entries can be used to extend the circle of authorized parties. The filter entries can describe individual computers or even entire networks. The access list can be found in the LANconfig in the configuration area 'TCP/IP' on the 'General' tab.

- Do you store your saved LANCOM configuration to a safe location?

Protect your saved configurations in a location that is safe from unauthorized access. Otherwise, by way of example, an unauthorized person may load your stored configuration file into another device and they can access the Internet at your expense.

- Concerning the exchange of your particularly sensitive data via wireless LAN; have you set up the functions offered by IEEE 802.1x?

If you move especially sensitive data via wireless LAN you can provide even stronger security by using the IEEE 802.1x technology. To check or activate the IEEE 802.1x settings in LANconfig select the configuration area '802.1x'.

- Have you activated the protection of your WAN access in case the device is stolen?

After being stolen, the device can theoretically be operated at another location by unauthorized persons. Password-protected device configurations do not stop third parties from operating RAS access, LAN connectivity or VPN connections that are set up in the device: A thief could gain access to a protected network.

The device's operation can be protected by various means; for example, it will cease to function if there is an interruption to the power supply, or if the device is switched on in another location.

With the ISDN location verification, the device can only be operated at one particular ISDN connection. After being switched on, the device calls itself at the corresponding telephone number to check that it is still connected to the "correct" ISDN connection (for further information see the reference manual).

GPS location verification enables a geographical position to be defined within the device. After being switched on the device automatically checks if it is located at the "correct" position. Only after a positive check is the router module activated.

The scripting function can store the entire configuration in RAM only so that restarting the device will cause the configuration to be deleted. The configuration is not written to the non-volatile flash memory. A loss of power because the device has been relocated will cause the entire configuration to be deleted (for further information see the reference manual).

For self-sufficient operations, the configuration for a WLAN interface being managed by a LANCOM WLAN Controller is stored in flash memory for a certain time only, or even in the RAM only. This device configuration is deleted if contact to the WLAN-Controller is lost or if the power supply is interrupted for longer than the set time period.

- Have you ensured that the reset button is safe from accidental configuration resets?

Some devices simply cannot be installed under lock and key. There is consequently a risk that the configuration will be deleted by mistake if a co-worker presses the reset button too long. The behavior of the reset button can be set so that a press is either ignored or it causes a re-start, depending on the time for which it is held pressed.

## 6.5 Addition(s) to LCOS 8.60

### 6.5.1 Support for TLS 1.1 / 1.2

The encryption protocol SSL or TLS ("Secure Sockets Layer" or "Transport Layer Security") supports secure data communication between two communication partners. For this purpose, SSL or TLS uses, for example, encryption, authentication and verification of certificates that have been sent. Although it is mainly used to secure HTTP connections (as "HTTPS" or "HTTP over SSL"), SLS or TLS serve as a basis for secure communications for many other transfer protocols.

LCOS uses the TLS protocol in the following modules:

- HTTP over SSL
- Telnet over SSL
- RADSEC
- CAPWAP/DTLS
- EAP-TLS/PEAP/TTLS

The TLS encryption protocol has been under development since 1999 and up to the current version TLS 1.2. To use the enhanced functionality of clients and web browsers, LANCOM devices support the TLS protocol of the versions 1.0, 1.1 and 1.2 for secure data transmission.

In the LCOS versions prior to 8.60, the encryption protocols SSL 3.0 and TLS 1.0 were always enabled by default. As of LCOS version 8.60 you can also select between the TLS versions 1.1 or 1.2 for HTTPS connections.

### Additions to the menu system

#### SSL versions

This setting allows you to opt for the latest encryption protocols for HTTPS connections.

 Please note that the encryption protocols set here only apply for HTTPS connections. For other protocols, the available encryption algorithms are fixed:

- EAP/TLS/TTLS/PEAP is set to TLS 1.0
- CAPWAP is set to DTLS 1.0 (which is based on TLS 1.1)
- Telnet/SSL is set to 'SSL 3.0+TLS 1.0 + TLS 1.1 + TLS 1.2'
- RADSEC is set to 'SSL 3.0+TLS 1.0'

#### SNMP ID:

221.18

#### Telnet path:

Setup > HTTP > SSL-Versions

#### Possible values:

SSLv3

TLSv1

TLSv1.1

TLSv1.2

#### Default:

SSLv3

TLSv1

## 7 Routing and WAN -connections

This chapter describes the most important protocols and configuration entries used for WAN connections. It also shows ways to optimize WAN connections.

### 7.1 General information

WAN connections are used for the following applications.

- Internet access
- LAN to LAN coupling
- Remote access

#### 7.1.1 Bridges for standard protocols

WAN connections differ from direct connections (for example, via the LANCAPI) in that the data in the WAN are transmitted via standardized network protocols also used in the LAN. Direct connections, on the other hand, operate with proprietary processes that have been specially developed for point-to-point connections.

Via WAN connections a LAN is extended, and with direct connections only one individual PC establishes a connection to another PC. WAN connections form a kind of bridge for the communication between networks (or for connecting individual computers to the LAN).

##### **Which protocols are used for WAN connections?**

WAN connections over highspeed ports (e.g. DSL connections) use the IP standard for transmitting packets. Devices with an ISDN interface provide beside IP additionally IPX.

##### **Close cooperation with router modules**

Characteristic of WAN connections is the close cooperation with the router modules in the LANCOM. The router modules (IP and IPX) provide the connection to LAN and WAN. They make use of the WAN modules to respond requests from PCs within the LAN for external resources.

#### 7.1.2 What happens in the case of a request from the LAN?

Initially the router modules only determine the remote station to which a data packet is to be sent to. The various parameters for all required connections must be arranged so that a given connection can be selected and established as required. These parameters are stored in a variety of lists, whose interaction permits the correct connections.



A simplified example will clarify this process. Here we assume that the IP address of the computer being searched for is known in the Internet.

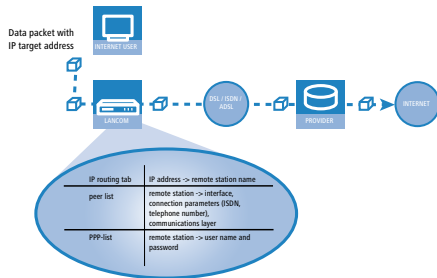

- 1. Selecting the correct route** A data packet from a computer initially finds the path to the Internet through the IP address of the receiver. The computer sends the packet with this address over the LAN to the router. The router determines the remote station in its IP routing table via which the target IP address can be reached, e.g. 'Provider\_A'.
- 2. Connection data for the remote station** Using these names, the router checks the remote station list and finds the necessary connection data for the provider. Included in these connection data are, for instance, the WAN interface (DSL, ISDN) through which the provider is connected to, protocol information, or the necessary number for an ISDN call connection. The router also obtains the user name and password required for login from the PPP list.
- 3. Establishing the WAN connection** The router can then establish a connection to a provider via a WAN interface. It authenticates itself with a user name and password.
- 4. Transmission of data packets** As soon as the connection is established, the router can send the data packet to the Internet.

## 7.2 IP routing

An IP router works between networks which use TCP/IP as the network protocol. This only allows data transmissions to destination addresses entered in the routing table. This section explains the structure of the IP routing table of an LANCOM Systems router, as well as the additional functions available to support IP routing.

### 7.2.1 The IP routing table

The IP routing table is used to tell the router which remote station (which other router or computer) it should send the data for particular IP addresses or IP address ranges to. This type of entry is also known as a "route" since it is used to describe the path of the data packet. This procedure is also called "static routing" since you make these entries yourself and they remain unchanged until you either change or delete them yourself. Naturally, "dynamic routing" also exists. The routers use the routes in this way to exchange data between themselves and continually update it automatically. The IP router uses the static and the dynamic routing table when the IP RIP is activated.

You also use the IP routing table to tell the router the length of this route's path so that it can select the most suitable route in conjunction with IP RIP where there are several routes to the same destination. The default setting for the distance to another router is 0, i.e. the router can be reached directly. All devices which can be reached locally, such as other routers in the same LAN or workstation computers connected via proxy ARP are entered with the distance 0. The "quality level" of this route will be reduced if the entry addressed has a higher distance (up to 14). "Unfavorable" routes like this will only be used if no other route to the remote station in question can be found.

#### Configuration of the routing table

LANconfig: IP-Router / Routing / Routing-Table

WEBconfig: LCOS menu tree / Setup / IP-Router / IP-Routing-Table

An IP routing table can, for example, look like this

:

IP address	Netmask	Routing-Tag	Router	Distance	Masquerading	Active
192.168.120.0	255.255.255.0	0	MAIN	2	Off	yes
192.168.125.0	255.255.255.0	0	NODE1	3	Off	yes
192.168.130.0	255.255.255.0	0	191.168.140.123	0	Off	yes

What do the various entries on the list mean?

- IP addresses and netmasks

This is the address of the destination network to which data packets may be sent and its associated network mask. The router uses the network mask and the destination IP address of the incoming data packets to check whether the packet belongs to the destination network.

The route with the IP address '255.255.255.255' and the network mask '0.0.0.0' is the default route. All data packets that cannot be routed by other routing entries are sent over this route.

- Routing Tag

With the routing tag the selection of the target route can be controlled more precisely. Therefore not only the target IP address for the selection of the route is detected but also other information, which is joined to the data packets by the firewall. With the routing tag "0" the routing entry is valid for all packets.

- Router

The router transmits the appropriate data packets to the IP address and network mask to this remote station.

- If the remote station is a router in another network or an individual workstation computer, this is the name of the remote station.
- If the router on the network cannot address the remote station itself, then the IP address of another router which knows the path to the destination network is entered.

The router name indicates what should happen with the data packets that match the IP address and network mask.

- Routes with the entry '0.0.0.0' identify exclusion routes. Data packets for this "zero route" are rejected and are not routed any further. That way routes which are forbidden on the Internet (private address spaces, e. g. '10.0.0.0'), for example, are excluded from transmission.
- If an IP address is input as router name, this is a locally available router, which is responsible for transfer of the relevant data packets.

- Distance

Number of routers between your own and the destination router. This value is often equated with the cost of the transmission and used to distinguish between inexpensive and expensive call paths for wide-area connections. The distance values entered are propagated as follows:

- All networks which can be reached while a connection exists to a destination network are propagated with a distance of 1.
- All non-connected networks are propagated with the distance entered in the routing table (but with a minimum distance of 2) as long as a free transmitting channel is still available.
- The remaining networks are propagated with a distance of 16 (= unreachable) if there are no longer any channels available.
- Remote stations connected using proxy ARP are an exception to this. These "proxy hosts" are not propagated at all.

- Masquerading

Use the 'Masquerade' option in the routing table to inform the router which IP addresses to use when transferring packets from local networks.

For further information see the section .

## 7.2.2 Policy-based routing

Policy-based routing does not rely exclusively upon the destination IP address to define the destination route (meaning the remote device that is to be used to transfer the data). Further information can be used—such as the service or the protocol used, sender addresses or the destination for the data packets—for the selection of the destination route. Policy-based routing can be used to achieve a significantly finer-grained routing behavior, such as in the following application scenarios:

- The LAN's entire Internet traffic is diverted to a proxy without entering the proxy address into the browsers. As the users do not notice the proxy routing, the scenario is named "transparent" proxy.

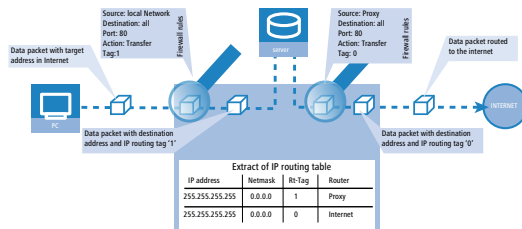

- With load balancing, the data traffic for selected protocols is diverted over a certain DSL port that uses an additional external ADSL modem.
- A server in the local network is only supposed to be accessible from the WAN via a fixed IP address; this is routed via a certain WAN interface.
- VPN traffic is forwarded to a VPN tunnel with dynamic end points by using the routing tag '0'; the company's remaining Internet traffic is diverted to another firewall by means of another suitable routing tag.

Suitable entries can be made in the firewall to select channels according to information other than just the destination IP address. These entries are supplemented with a special routing tag that is used to control the channel selection with the routing table. For example, a rule adds the routing tag '2' to the entire data traffic for a local group of computers (defined by an IP address range). Alternatively, certain protocols receive a different supplementary routing tag.

The diagram demonstrates the application of policy-based routing with load balancing:

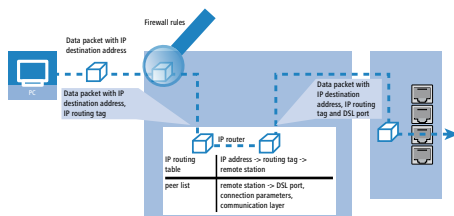

- When establishing a connection, the firewall initially checks if the packets for transmission fit to a rule which contains a routing tag. The routing tag is entered into the data packet.
- The IP routing table combines the routing tag and destination IP address to determine the appropriate remote station. The IP routing table is processed from top down in the usual fashion.
- If an entry is found corresponding to the network, then the second step is to check the routing tag. The required remote station can be found with the help of the appropriate routing tag.



If the routing tag has a value of "0" (default) then the routing entry applies to all packets.

- Internal services implicitly use the default tag. If the user wishes to direct the default route through a VPN tunnel with a dynamic tunnel endpoint, for example, then the VPN module uses the default route with the routing tag "0" as standard.

To direct the default route through the VPN tunnel anyway, create a second default route with routing tag "1" and the VPN remote station as router names. With the appropriate firewall rule you can transfer all services from all source stations to all destination stations with routing tag "1".

- Routing tags and RIP: The routing tag is also transmitted in RIP packets for processing upon reception, so that, for example, the change in distances in the proper route can be changed.

### Routing tags for VPN and PPTP connections

Routing tags are used on the LANCOM in order to evaluate criteria relevant to the selection of the target route in addition to the IP address. In general, routing tags are added to the data packets using special firewall rules. However, in some cases, it is desirable to assign the tags directly.

- Routing tags for VPN connections

The VPN name list can be used to enter the routing tag for every VPN connection. The routing tag is used in order to determine the route to the remote gateway (default '0').

In addition, every gateway can be assigned a specific routing tag in the gateway table. The tag 0 has a special function in this table: If the tag is set at 0 on a gateway, then the tag from the VPN name list table is used.

The VPN routing tag parameters can be found under Setup/VPN/VPN Peers or Setup/VPN/Additional Gateways and under LANconfig in the configuration area 'VPN' on the 'General' tab by clicking on 'Connection List' and 'Other remote gateways' in the list.

- Routing tags for PPTP connections

In the PPTP table, a routing tag can be entered in addition to the IP address of the PPTP server. Using this routing tag, two or more DSL modems that use a single IP address can be operated on different DSL ports.

Peer	IP Address	Rtg tag	Port	SH time
PEER01	10.0.0.138	1	1723	9999
PEER02	10.0.0.138	2	1723	9999

In the IP routing table, two appropriately tagged routes are required:

IP address	IP netmask	Rtg tag	Peer or IP	distance	Masquerading
10.0.0.138	255.255.255.255	2	PEER02 PPTP	0	No
10.0.0.138	255.255.255.255	1	PEER01 PPTP	0	No
192.168.0.0	255.255.0.0	0	0.0.0.0	0	No
172.16.0.0	255.240.0.0	0	0.0.0.0	0	No
10.0.0.0	255.0.0.0	0	0.0.0.0	0	No
224.0.0.0	224.0.0.0	0	0.0.0.0	0	No
255.255.255.255	0.0.0.0	0	PEER LB	0	yes

Using these settings and the corresponding entry in the load balancing table, load balancing can be performed that would also work in Austria.

Peer	Bundle Peer 1	Bundle Peer 2	Bundle Peer 3
PEER LB	PEER01	PEER02	

## 7.2.3 Local routing

You know the following behavior of a workstation within a local network: The computer searches for a router to assist with transmitting a data packet to an IP address which is not on its own LAN. This router is normally introduced to the operating system with an entry as standard router or standard gateway. It is often only possible to enter one default router which is supposed to be able to reach all the IP addresses which are unknown to the workstation computer if there are several routers in a network. Occasionally, however, this default router cannot reach the destination network itself but does know another router which can find this destination.

## How can you assist the workstation computer now?

By default, the router sends the computer a response with the address of the router which knows the route to the destination network (this response is known as an ICMP redirect). The workstation computer then accepts this address and sends the data packet straight to the other router.

Certain computers, however, do not know how to handle ICMP redirects. To ensure that the data packets reach their destination anyway, use local routing. In this way you instruct the router itself in your device to send the data packet to other routers. In addition, in this case no more ICMP redirects will be sent. The setting is made under:

LANconfig: IP router / General / Forward packets within the local network

WEBconfig: LCOS menu tree / Setup / IP-router / Loc.-routing

Local routing can be very helpful in isolated cases, however, it should also only be used in isolated cases. For local routing leads to a doubling of all data packets to the desired target network. The data is first sent to the default router and is then sent on from here to the router which is actually responsible in the local network.

## Addition(s) to LCOS 7.80

### Setting the routing tag for local routes

The definition of interface tags in Advanced Routing and Forwarding (ARF) facilitates the use of virtual routers, which only use a part of the overall routing table. The interface tag for a packet received from another local router is set according to the following procedure:

1. If the a packet's sender address is recognized as coming from an IP network which is defined in the device, then the interface tag for that IP address is used.
2. If the interface receiving the packet is connected to just one IP network, then the interface tag for that IP network is used.
3. If there is no unique result from steps 1 and 2, the device attempts to use the MAC address to determine the IP address of the next hop (reverse ARP lookup). The devices uses this IP address in an attempt to identify the relevant IP network, and thus the corresponding interface tag.
4. If there is no unique result from options 1 to 3, then the device attempts to identify the relevant IP network (and interface tag) from the routing table.

## 7.2.4 Dynamic routing with IP RIP

In addition to the static routing table, LANCOM Systems routers also have a dynamic routing table. Unlike the static table, you do not fill this out yourself, but leave it to be dealt with by the router itself. It uses the Routing Information Protocol (RIP) for this purpose. All devices that support RIP use this protocol to exchange information on the available routes.

### What information is propagated by IP RIP?

A router uses the IP RIP information to inform the other routers in the network of the routes it finds in its own static table. The following entries are ignored in this process:

- Rejected routes with the '0.0.0.0' router setting.
- Routes referring to other routers in the local network.
- Routes linking individual computers to the LAN by proxy ARP.

Although the entries in the static routing table are set manually, this information changes according to the connection status of the router and so do the RIP packets transmitted.

- If the router has established a connection to a remote station, it propagates all the networks which can be reached via this route in the RIPs with the distance '1'. Other routers in the LAN are thus informed by these means that a connection to the remote station has been established on this router which they can use. The establishment of additional connections by routers with dial-up connections can be prevented, thus reducing connection costs.

- If this router cannot establish a further connection to another remote station, all other routes are propagated with the distance '16' in the RIP. The '16' stands for "This route is not available at the moment". A router may be prevented from establishing a connection in addition to the present one may be due to one of the following causes:
  - Another connection has already been established on all the other channels (also via the LANCAPI).
  - Y connections for the S0 port have been explicitly excluded in the interface table.
  - The existing connection is using all B channels (channel bundling).
  - The existing connection is a leased-line connection. Only a few ISDN providers enable a dial-up connection to be established on the second B channel in addition to a permanent connection on the first B channel.

### Which information does the router take from received IP RIP packets?

When the router receives such IP RIP packets, it incorporates them in its dynamic routing table, which looks something like this:

IP address	IP netmask	Time	Distance	Router
192.168.120.0	255.255.255.0	1	2	192.168.110.1
192.168.130.0	255.255.255.0	5	3	192.168.110.2
192.168.140.0	255.255.255.0	1	5	192.168.110.3

### What do the entries mean?

IP address and network mask identify the destination network, the distance shows the number of routers between the transmitter and receiver, the last column shows which router has revealed this route. This leaves the 'Time'. The dynamic table thus shows how old the relevant route is. The value in this column acts as a multiplier for the intervals at which the RIP packets arrive. A '1', therefore, stands for 30 seconds, a '5' for about 2.5 minutes and so on. New information arriving about a route is, of course, designated as directly reachable and is given the time setting '1'. The value in this column is automatically incremented when the corresponding amount of time has elapsed. The distance is set to '16' after 3.5 minutes (route not reachable) and the route is deleted after 5.5 minutes.

Now if the router receives an IP RIP packet, it must decide whether or not to incorporate the route contained into its dynamic table. This is done as follows:

- The route is incorporated if it is not yet listed in the table (as long as there is enough space in the table).
- The route exists in the table with a time of '5' or '6'. The new route is then used if it indicates the same or a better distance.
- The route exists in the table with a time of '7' to '10' and thus has the distance '16'. The new route will always be used.
- The route exists in the table. The new route comes from the same router which notified this route, but has a worse distance than the previous entry. If a device notifies the degradation of its own static routing table in this way (e.g. releasing a connection increases the distance from 1 to 2, see below), the router will believe this and include the poorer entry in its dynamic table.

 RIP packets from the WAN will be ignored and will be rejected immediately. RIP packets from the LAN will be evaluated and will not be propagated in the LAN.

### The interaction of static and dynamic tables

The router uses the static and dynamic tables to calculate the actual IP routing table it uses to determine the path for data packets. In doing so, it includes the routes from the dynamic table which it does not know itself or which indicate a shorter distance than its own (static) route with the routes from its own static table.

## Scaling with IP RIP

If you use several routers in a local network with IP RIP, you can represent the routers outwardly as one large router. This procedure is also known as "scaling". As a result of the constant exchange of information between the routers, such a router theoretically has no limits to the transmission options available to it.

## Configuration of IP-RIP function

You can fill in the corresponding remote stations in the WAN-RIP-table, to declare the static defined routes over the WAN, which are learned over RIP, or to learn routes from the WAN.

WEBconfig: Setup / IP-router / RIP / WAN table

LANconfig: IP-Router / General / WAN RIP

! Routers with RIP capabilities dispatch the RIP packets approximately every 30 seconds. The router is only set up to send and receive RIPs if it has a unique IP address. The IP RIP module is deselected in the default setting using the IP address xxx.xxx.xxx.254.

## RIP filter

Routes learned from RIP can be filtered by their routing tag according to the settings for LAN and WAN RIP. Routes can additionally be filtered by specifying network addresses (e. g. "Only learn routes in the network 192.168.0.0/255.255.0.0"). First of all a central table is used to define the filters that can then be used by entries in the LAN and WAN RIP table. Initially the filters are defined in a central table; these can then be used by entries in the LAN and WAN RIP table.

LANconfig: IP-Router / General/ RIP filter sets

WEBconfig: Setup / IP-Router / RIP / filter

## Set up RIP for separate networks

Most of the time it is not required (as well as for NetBIOS-Proxy), that the local network structure is propagated over RIP to the DMZ. Furthermore it is sometimes required, to propagate the known routes to a certain network, but not to learn routes from the network (eg. in the WAN). Therefore the RIP functionality can be set up for every network separately.

LANconfig: IP-Router / General / RIP networks

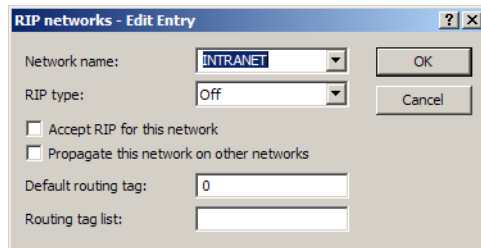

WEBconfig: LCOS-menu tree / Setup / IP-Router / RIP / LAN-table

## Timer settings

The Routing Information Protocol (RIP) regularly provides neighboring routers with updates on the available networks and the associated metrics (hops). RIP uses various timers to control the exchange of routing information.

- WEBconfig: Setup/ IP-router/ RIP/ Parameters

## Triggered update in the LAN

With a triggered update, changes to the metrics are immediately reported to the neighboring router. The system does not wait until the next regular update. An update delay stops faulty configurations from causing excessive update messages.

- Update delay

The update delay starts as soon as the routing table, or parts of it, are propagated. As long as this delay is running, new routing information is accepted and entered into the table but it is not reported any further. The router actively reports its current entries only after expiry of this delay.

The value set here sets the upper limit for the delay—the actual delay is a random value between one second and the value set here.

## Triggered update in the WAN

Other than in the LAN, WAN bandwidth limitations may make regular updates every 30 seconds undesirable. For this reason, RFC 2091 requires that routes are transmitted to the WAN once only when the connection is established. After this, updates only are transmitted.

Because updates are explicitly requested here, broadcasts or multicasts are not to be used for delivering RIP messages. Instead, the subsidiary device must be statically configured with the IP address of the next available router at the central location. Due to these requests, the central router knows which subsidiary routers it has received update requests from; it then sends any messages on route changes directly to the subsidiary device.

The WAN-RIP table has been extended for configuring the triggered update in the WAN.

## Poisoned reverse

Poisoned reverse prevents routing loops from forming. An update is sent back to the router that propagated the route to inform it that the network is unreachable at the associated interface.

However, this has a significant disadvantage over WAN connections: The central location transmits a high number of routes which would then suffer from route poisoning, so leading to a heavy load on the available bandwidth. For this reason, poisoned reverse can be manually activated for every LAN/WAN interface.

The LAN and WAN RIP tables have been extended for the configuration of poisoned reverse.



### Static routes for constant propagation

Routers use RIP to propagate not only dynamic routes but statically configured routes as well. Some of these static routes may not be constantly available, for example when an Internet connection or dial-up access is temporarily unavailable.

For a static route, the setting for "Active" in the routing table defines whether it should be propagated constantly or only when it is actually reachable.

- WEBconfig: Setup/ IP-Router/ IP-Routing-Table

## 7.2.5 SYN/ACK speedup

The SYN/ACK speedup method is used to accelerate IP data traffic. With SYN/ACK speedup IP check characters (SYN for synchronization and ACK for acknowledge) a given preference within the transmission buffer over simple data packets. This prevents the situation that check characters remain in the transmission queue for a longer time and the remote station stop sending data as a result.

The greatest effect occurs with SYN/ACK speedup with fast connections (e. g. ADSL) when data quantities are simultaneously transferred in both directions at high speed.

The SYN/ACK speedup is activated at the factory.

### Switching off in case of problems

Due to the preferred handling of individual packets, the original packet order is changed. Although TCP/IP does not ensure a certain packet order, problems may result in a few isolated applications. This only concerns applications that assume a certain order that differs from the protocol standard. In this case the SYN/ACK speedup can be deactivated:

LANconfig: IP router / General / Pass on TCP SYN and ACK packets preferentially

WEBconfig: LCOS menu tree / Setup / IP router / Routing method / SYN/ACK speedup

## 7.3 Advanced Routing and Forwarding

### 7.3.1 Introduction

Up until LCOS version 6.30, LANCOM Routers supported two local networks only: The intranet and the DMZ. For some applications, however, it may be desirable to realize more than one intranet and one DMZ with a LANCOM Router, for example to provide multiple IP networks with Internet access via a central router. As of LCOS version 7.00, LANCOM Routers support up to 64 different IP networks, depending on the model.

Various scenarios are possible when realizing multiple IP networks:

- One network per interface.
- Multiple networks per interface.
- Multiple VLANs per interface; one or more networks per VLAN (which corresponds with a combination of the first two scenarios).

The realization of these scenarios is facilitated by advanced routing and forwarding (ARF), which provides very flexible options in the definition of IP networks and the assignment of these networks to the interfaces. The diagram below

illustrates the network/interface assignment at various levels. The configuration options applied here are described in the following chapters.

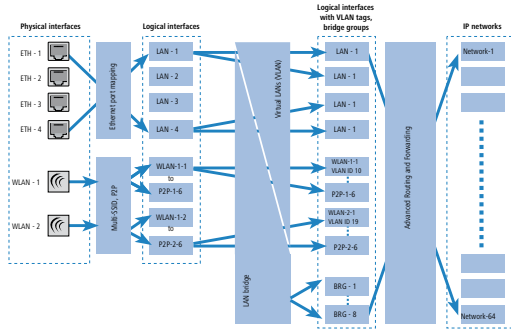

The assignment of IP networks to interfaces proceeds as follows:

- The various models have different numbers of physical interfaces, i.e. Ethernet ports or WLAN modules.
  - The logical interface(s) is/are assigned to the physical interface:
    - For the Ethernet ports, Ethernet port mapping assigns the physical ETH-1 to ETH-4 to the logical LAN-1 to LAN-4.
- 
- ! For some but not all models, the number of logical LAN interfaces corresponds to the number of physically available Ethernet ports.
    - In the case of the WLAN modules, the establishment of point-to-point connections (P2P) and/or the use of Multi-SSID can mean that multiple WLAN interfaces are assigned to each physical WLAN module: Per module this may be up to eight WLAN networks and up to six P2P connections.
  - These logical interfaces are further specified and grouped in the next stage:
    - For devices supporting VLAN, multiple VLANs can be defined for each logical interface simply by using VLAN-IDs. Although the data traffic for the various VLANs flows via a common logical interface, the VLAN-ID ensures that the different VLANs remain strictly separated. From the perspective of the LANCOM Router the VLANs are completely separate interfaces, meaning that a single logical interface becomes multiple logical interfaces for the LANCOM Router, and each of these interfaces can be addressed individually.
    - For devices with WLAN modules, the individual logical interfaces can be grouped together. This is handled by the LAN bridge which regulates data transfer between the LAN and WLAN interfaces. The formation of bridge groups (BRG) allows multiple logical interfaces to be addresses at once and they appear as a single interface to the LANCOM Router—in effect achieving the opposite of the VLAN method.
  - In the final stage, the ARF forms a connection between the logical interfaces with VLAN tags and the bridge groups on the one side, and the IP networks on the other. For this reason, an IP network is configured with a reference to a logical network (with VLAN-ID, if applicable) or to a bridge group. Furthermore, for each IP network an interface tag can be set, with which the IP network can be separated from other networks without having to use firewall rules.

The definition of routing tags for IP networks as described above is one of the main advantages of Advanced Routing and Forwarding. This option allows "virtual routers" to be realized. A virtual router only takes up a portion of the routing table by using interface tags for a IP-network and therefore configures routing individually for this particular IP-network. This method allows, for example, several default routes to be defined in the routing table, each of which is given a routing tag. Virtual routers in the IP networks use the tags to select the default route which applies to the IP network with the appropriate interface tag. The separation of IP networks via virtual routers even permits multiple IP networks with one and the same address range to be operated in parallel in just one LANCOM Router without problem.

For example: Within an office building, a number of companies have to be connected to the Internet via a central LANCOM Router, even though each of these companies has its own Internet provider. All of the companies want to use the popular IP network '10.0.0.0' with the netmask '255.255.255.0'. To implement these requirements, each company is given an IP network '10.0.0.0/255.255.255.0' with a unique name and a unique interface tag. In the routing table, a default route with the corresponding routing tag is created for each Internet provider. This allows the clients in the different company networks, all of which use the same IP addresses, to access the Internet via their own provider. Employing

VLANs enables logical networks to be separated from one another even though they use the same physical medium (Ethernet).

### The differences between routing tags and interface tags

Routing tags as assigned by the firewall and interface tags as defined by the IP networks have a great deal in common, but also some important differences:

- The router interprets both tags in the same way. Packets with the interface tag '2' are valid for routes with the routing tag set to '2' in the routing table (and all routes with the default route tag '0'). The same routes apply for packets which the firewall has assigned with the routing tag '2'.

Thus the interface tag is used in the same way as a routing tag.

- Interface tags have the additional ability to delimit the visibility (or accessibility) between different networks:
  - In principle, only networks with the same interface tag are "visible" to one another and thus able to interconnect.
  - Networks with the interface tag '0' have a special significance; they are in effect supervisor networks. The networks can see all of the other networks and can connect to them. Networks with an interface tag not equal to '0' cannot make connections to supervisor networks, however.
  - Networks of the 'DMZ' type can be seen by all other networks independently of their interface tag - which makes sense, since the DMZ often contains servers which are open to the public, like webservers etc.. The DMZ-networks only see networks with the same interface tag (and of course all other DMZ-networks).

Networks of the 'DMZ' type with the interface tag '0' have a special significance: As "supervisor networks" they can see all other networks, and they are also visible to all other networks.

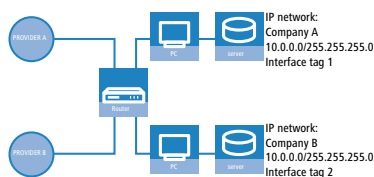

### Routing table

IP address	Netzmaske	Interface tag	Router
255.255.255.255	0.0.0.0	1	Provider A
255.255.255.255	0.0.0.0	2	Provider B

⚠ For cases which do not allow IP addresses to be uniquely assigned by interface tag, the Advanced Routing and Forwarding can be supported by firewall rules. In the above example, this would be the case if each of the networks were to support a public web or mail server, all of which use the same IP address.

## 7.3.2 Defining networks and assigning interfaces

When defining a network, the first setting is for the IP-address range which is to be valid for a certain local interface on the LANCOM Router. "Local interfaces" are logical interfaces which are assigned either to a physical Ethernet port (LAN) or a wireless port (WLAN). To realize the scenarios outlined above, it is possible for several networks to be active on one interface: Conversely, a network can also be active on multiple interfaces (via bridge groups or with the interface assignment 'Any').

The networks are defined in a table. A unique name for the networks is set along with definitions for the address range and interface assignment. The network name allows the identification of networks in other modules (DHCP server, RIP, NetBIOS, etc.) and to enable control over which services are available in which networks.

TCP/IP / General / IP networks

### 7.3.3 Assigning logical interfaces to bridge groups

Particular properties of the logical interfaces are defined in the port table.

LANconfig: Interfaces / LAN / Port table

WEBconfig: LCOS menu tree / Setup / LAN Bridge / Port Data

- Active

This option activates or deactivates the logical interface.

- Bridge group

Assigns the logical interface to a bridge group to enable bridging from/to this logical interface via the LAN bridge. If assigned to a common bridge group, several logical interfaces can be addressed at once and they appear to the LANCOM Router to be a single interface. This can then be used for Advanced Routing and Forwarding, for example.

If the interface is removed from all bridge groups by setting 'none', then there is no communication between the LAN and WLAN via the LAN bridge (isolated mode). With this setting, LAN/WLAN data transfers over this interface are only possible via the router.



A requirement for data transfer from/to a logical interface via the LAN bridge is the deactivation of the global "isolated mode" which applies to the whole of the LAN bridge. Furthermore, the logical interface must be assigned to a bridge group. With the setting 'none', no transfers can be made via the LAN bridge.

- Priority

Sets the priority for the logical interface where the spanning-tree protocol is being used. Where multiple connections are available, the interface with the highest priority is used. The smaller the value, the higher the priority. If priorities are the same then the interface with lower transmission fees is chosen or, alternatively, the interface which is highest in the table.

- DHCP limit

Number of clients which can be handled by DHCP. If the limit is exceeded, the oldest entry is dropped. This feature can be used in combination with the protocol filer table to limit access to just one logical interface.

### 7.3.4 Interfaces tags for remote sites

By defining interfaces tags, virtual routers can be used as part of Advanced Routing and Forwarding (ARF) that only use part of the overall routing table. For inbound data packets from the WAN, the assignment of interfaces tags can be regulated in different ways:

- By using appropriate firewall rules that only capture data packets from particular remote sites, IP addresses or ports
- Based on the routing table
- Via an explicit assignment of tags to remote sites.

This assignment of tags to the remote sites to separate ARF networks can also be conveniently used for packets received at the WAN-side (which by default contain Tag 0). Without controlling the assignment of tags explicitly with the firewall, the virtual router can be determined directly from the remote site or source route from the form of the interface tag. Inbound and outbound communication can thus be easily divided between virtual routers bidirectionally.

 The interface tags determined via the tag table and on the basis of the routing table can be overwritten with an appropriate entry in the firewall.

#### Assignment of interface tags via the tag table

LANconfig: Communication / Remote sites / WAN tag table

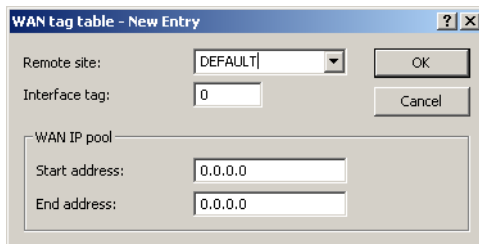

WEBconfig: Setup / IP router

- WAN tag generation

WAN tag generation defines the source for the assignment of interfaces tags. Besides assignment via the firewall or direct assignment via the tag table, the interface tag can also be selected based on the source route in the effective routing table (static routing entries plus routes learned via RIP). The source IP and the name of the remote site used to establish the IP connection is compared with the routing information. The routing tag of this source route is assigned for further processing to the packets received at the WAN-side of this connection. If the effective routing table contains more than one entry for a remote site with the same network, the smallest tag is used.

Example: The following ARF networks have been defined:

Network	IP address	Rtg tag	Port
PRIVATE	192.168.1.1/24	1	LAN -1
HOME-OFFICE	192.168.10.1/24	10	LAN -2

PRIVATE is to have Internet access only, HOME-OFFICE is to have a VPN tunnel to the remote site VPN-COMPANY only. The corresponding effective routing table appears as follows:

IP address	IP netmask	Rtg tag	Remote site	Distanz	Masking
192.168.10.0	255.255.255.0	10	VPN-COMPANY	0	No
255.255.255.255	0.0.0.0	1	INTERNET	0	No

- Data packet coming from network 192.168.10.x: Tag = 10
- Data packet coming from network 192.168.1.x: Tag = 1
- Data packet coming from any other network: Tag = 0

Possible values:

- Manual: With this setting, the interface tags are determined solely by an entry in the tag table. The routing table has no significance in the assignment of interfaces tags.
- Auto: With this setting, the interface tags are determined initially by an entry in the tag table. If no matching entry is located there, the tag is determined based on the routing table.

 The interface tags determined via the tag table and on the basis of the routing table can be overwritten with an appropriate entry in the firewall.

### 7.3.5 Virtual routers

With interface-dependent filtering in combination with policy-based routing, virtual routers can be defined for every interface.

Example:

Two separate IP networks are used by the Development and Sales departments. Both networks are connected to different switch ports although they use the same network '10.1.1.0/255.255.255.0'. Sales should be able to enter the Internet only, whereas Development should also have access to a partner company's network ('192.168.1.0/255.255.255.0').

The result is the following routing table (where the Development dept. has tag 2, Sales has tag 1):

IP address	IP netmask	Rtg tag	Peer or IP	Distanz	Masking	Active
192.168.1.0	255.255.255.0	2	PARTNER	0	No	yes
192.168.0.0	255.255.0.0	0	0.0.0.0	0	No	yes
255.255.255.255	0.0.0.0	2	INTERNET	2	yes	yes
255.255.255.255	0.0.0.0	1	INTERNET	2	yes	yes

If Development and Sales were in IP networks with different address ranges, then it would be no problem to assign the routing tags with firewall rules. Since both departments are in the same IP network, the only available method of assignment is with network names.

Tag assignment can be carried out directly in the network definition

:

Network name	IP address	Netzmaske	VLAN ID	Interface	Source check	Type	Rtg tag
DEVELOPMENT	10.1.1.1	255.255.255.0	0	LAN -1	strict	Intranet	2
SALES	10.1.1.1	255.255.255.0	0	LAN -2	strict	Intranet	1

Alternatively the assignment of tags can be carried out with a combination of network definitions and firewall rules. The networks are defined as follows:

Network name	IP address	Netzmaske	VLAN ID	Interface	Source check	Type	Rtg tag
DEVELOPMENT	10.1.1.1	255.255.255.0	0	LAN -1	strict	Intranet	0
SALES	10.1.1.1	255.255.255.0	0	LAN -2	strict	Intranet	0

Routing tags can be used to define the following firewall rules:

Name	Protocol	Source	Destination	Action	Linked	Prio	(...)	Rtg tag
DEVELOPMENT	ANY	%Ldevelopment	ANYHOST	%a	yes	255		2
SALES	ANY	%Lsales	ANYHOST	%a	yes	255		1

Important for these rules is the maximum priority (255) so that these rules are always checked first. Since filtering is still possible by services, the option "Linked" has to be set in the firewall rule.

### 7.3.6 NetBIOS proxy

For security reasons, the behavior of the NetBIOS proxy has to be adjusted to the relevant networks, for example because it normally is not to be active within the DMZ. For this reason, the NetBIOS proxy can be configured separately for each network.

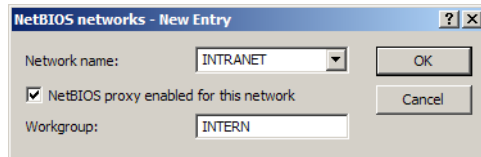

LANconfig: NetBIOS / General / NetBIOS networks

WEBconfig: LCOS menu tree / Setup / NetBIOS / networks

- Network name

Name of the network that the NetBIOS proxy is to be activated for.

- NetBIOS proxy operating for the network

This option shows if the NetBIOS-proxy is activated for the selected network.

- Workgroup

The workgroup or domain used by the network clients. With multiple workgroups, mentioning one workgroup suffices.

 In the default setting 'Intranet' and 'DMZ' are entered into this table; the NetBIOS proxy is activated for the intranet and deactivated for the DMZ.

As soon as a network has an interface tag, then the only names (hosts and groups) visible from this network are those in a network with the same tag, or which are accessible via a suitably tagged (with the same tag) WAN route. An untagged network sees all names. Similarly, all names learned from untagged networks are visible to all networks.

The DNS server considers the interface tags when resolving names, i.e. the only names resolved by DNS are those learned from a network with the same tag. The special role played by untagged networks applies here too.

The workgroup/domain enables networks to be scanned for NetBIOS names when a device is started. The workgroup is different for every network and has to be defined everywhere. In networks without domains, the name of the largest workgroup should be defined here.

## 7.4 Configuration of remote stations

Remote stations are configured in two tables:

- In the peer list(s) all information is set that applies individually to only one remote station.
- Parameters for the lower protocol levels (below IP or IPX) are defined in the communication layer table.

 The configuration of the authentication (protocol, user name, password) is not covered in this section. Information on authentication is contained in the section .

### 7.4.1 Peer list

The available remote stations are created in the peer list with a suitable name and additional parameters. For every WAN interface exists a separate peer list. The peer list reached as follows: For every WAN interface exists a separate peer list. The peer list reached as follows. LANconfig: Communication / Remote sites / Remote Sites (DSL)

WEBconfig: LCOS menu tree / Setup / WAN / DSL-Broadband-Peers

For the remote stations following parameters are required:

Peer list	Parameter	Meaning
DSL	Name	With this name the remote stations are identified in the router modules. As soon as the router module has detected the remote station (using the IP address of the destination), the connection parameters are located in the peer list.
	Short hold	This time indicates how long the connection is kept if no data is being transmitted anymore.  If zero is entered, the connection does not terminate automatically. If 9999 seconds are entered a broken off connection is rebuild automatically.
	Access concentrator	The Access concentrator (AC) is a server, which can be accessed by the remote station. If several ADSL providers are listed, select the provider that is responsible for the remote station (using the name of the AC).  The value for the AC is advised to you by your provider. If no value is entered for the AC, every AC is accepted that provides the demanded service.
	Service	Enter the service you would like to use from your provider. The service can be e.g. internet surfing or even video downstream.  The value for the service is advised to you by your provider. If no value is entered, every Service is accepted that is provided by the AC.
	Layer name	Select the layer name for the connection. The configuration of this layer is described in the following section.
	VPI	Virtual Path Identifier.
	VCI	Virtual Channel Identifier. The value for VCI and VPI are advised to you by your provider. Standard values for the combination of VPI and VCI are: 0/35, 0/38, 1/32, 8/35, 8/48.
	Dialup-Peers	Name
Phonenumber		A Phonenumber is only then required, if the remote station must be called. This field can remain empty if only incoming calls should be accepted. Several phonenumber for the same remote station can be entered in the RoundRobin list.
Short hold		See DSL-Broadband-Peers
Short hold 2		The second B channel is cut down, if it is not used for the set duration.
Layer name		See DSL-Broadband-Peers
Callback		The automatic callback provides a secure connection and decreases the costs for the caller. Further information can be found in the next section .

 Please note following points when editing the peer list:

- If two identical peer lists (e.g. DSL-Broadband-Peers list and Dialup-Peers list) are entered, the LANCOM when connecting to the remote station uses the "faster" interface. The other interface is then used as a backup.
  - If nor the access concentrator neither the service is specified the router connects to the first AC that answers the query.
  - In the occasion of a DSLoL interface the same entries as for the DSL interface are valid. The entries are made in the Broadband-Peers list.



## 7.4.2 Layer list

With a layer, a collection of protocol settings are defined, which should be used when connecting to specific remote stations. The list of the communication layers can be found under:

LANconfig: Communication / General / Communication layers

WEBconfig: LCOS menu tree / Setup / WAN / Layer-list

In the communication layer list the common protocol combinations are already predefined. Changes or additions should only be made when remote stations are incompatible to the existing layers. The possible options are contained in the following list.

 Please note that the parameters located in LANCOM depend upon the functionality of the unit. It is possible that your unit does not offer all of the options described here

Parameter	Meaning
Layer name	The layer is selected in the peer list under this name.
Encapsulation	Additional encapsulations can be set for data packets. 'Transparent' No additional encapsulations. 'Ethernet' Encapsulation in the form of ethernet frames. 'LLC-MUX' Multiplexing via ATM with LLC/SNAP encapsulation according to RFC 2684. Several protocols can be transmitted over the same VC (Virtual Channel). 'VC-MUX' Multiplexing with ATM by establishing additional VCs according to RFC 2684.
Layer-3	The following options are available for the switching layer or network layer: 'Transparent' No additional header is inserted. 'PPP' The connection is established according to the PPP protocol (in the synchronous mode, i.e. bit-oriented). The configuration data are taken from the PPP table. 'AsyncPPP' Like 'PPP', only the asynchronous mode is used. This means that PPP functions character-oriented. '... with script' All options can be run with their own script if desired. The script is specified in the script list. 'DHCP' Assignment of the network parameters via DHCP.
Layer-2	In this field the upper section of the security layer (Data Link Layer) is configured. The following options are available: 'Transparent' No additional header is inserted. 'PPPoE' Encapsulation of the PPP protocol information in ethernet frames. 'PPPoE' The PPP negotiation runs via Ethernet. The PPP packets are encapsulated in Ethernet frames for this purpose. This process is frequently used for DSL connections.
Options	Here you can activate the compression of the data to be transmitted and the bundling of channels. The selected option only becomes active when it is supported by both the ports used and the selected Layer-2 and Layer-3 protocols. For further information see section .
Layer-1	In this field the lower section of the security layer (Data Link Layer) is configured. The following options are available: 'AAL-5' ATM adaptation layer 'ETH-10' Transparent Ethernet as per IEEE 802.3. 'HDLC' Securing and synchronization of the data transfer as per HDLC (in the 7 or 8-bit mode). 'V.110' Transmission as per V.110 with a maximum of 38,400 bps. Modem Modem transmission (requires Fax Modem option)

## 7.5 IP masquerading

One of today's most common tasks for routers is connecting the numerous workstation computers in a LAN to the network of all networks, the Internet. Everyone should have the potential to access, for example, the WWW from his workstation and be able to fetch bang up-to-date information for his work. ´

So that not every single computer with it's IP address in known on the entire internet "IP masquerading" is used to hide all computers located in an intranet. IP masquerading demands two points from a router: On the one hand a valid IP address in the local network, on the other hand a valid and public IP address in the internet (static or assigned by the provider).

Because these two addresses are not allowed to exist in one logical net, the router must have two IP addresses:

- the intranet IP address to communicate with computers in the LAN
- the public IP address to communicate with remote stations in the Internet

The computers in the LAN use the router as a gateway but are not recognizable themselves. The router divides the intranet from the internet.

### 7.5.1 Simple masquerading

#### How does IP masquerading work?

Masquerading makes use of a characteristic of TCP/IP data transmission, which is to use port numbers for destination and source as well as the source and destination addresses. When the router receives a data packet for transfer it now notes the IP address and the sender's port in an internal table. It then gives the packet its unique IP address and a new port number, which could be any number. It also enters this new port on the table and forwards the packet with the new information.

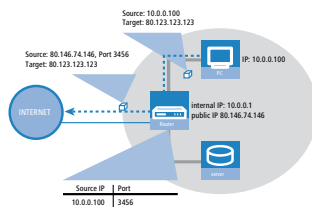

The response to this new packet is now sent to the IP address of the router with the new sender port number. The entry in the internal table allows the router to assign this response to the original sender again.

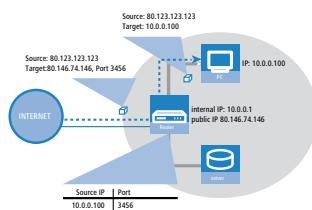

#### Which protocols can be transmitted using IP masquerading?

IP masquerading for all IP protocols that are based on TCP, UDP, or ICMP and communicate exclusively through ports. One example of this type of uncomplicated protocol is the one the World Wide Web is based on: HTTP.

Individual IP protocols do use TCP or UDP, but do not, however communicate exclusively through ports. This type of protocol calls for a corresponding special procedure for IP masquerading. Among the group of protocols supported by IP masquerading in the LANCOM are:

- FTP (using the standard ports)

- H.323 (to the same extent as used by Microsoft Netmeeting)
- PPTP
- IPSec
- IRC

### Configuration of IP masquerading

The use of IP masquerading is set individually for each route in the routing table. The routing table can be reached as follows:

LANconfig: IP router / Routing / Routing table

WEBconfig: LCOS menu tree / Setup / IP-router / IP-routing-table

## 7.5.2 Inverse masquerading

Simple masquerading has the effect, that all IP addresses in the local network are masked behind the IP address of the router. But when using simple masquerading if a certain computer on the LAN is supposed to be available for stations on the internet (e.g. FTP server) the IP address of the FTP server is not visible either. A connection to this FTP server from the internet is not possible.

To enable the access to such a server ('exposed host') in the LAN, the IP address of the FTP server must be entered with all services that are also supposed to be available from outside the LAN. If a computer sends a packet from the Internet to, for example, an FTP server on the LAN, from the point of view of this computer the router appears to be the FTP server. The router reads the IP address of the FTP server in the LAN from the entry in the service table. The packet is forwarded to this computer. All packets that come from the FTP server in the LAN (answers from the server) are hidden behind the IP address of the router.

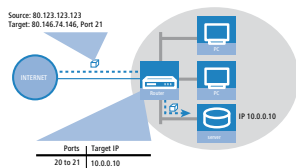

The only small difference is that:

- Access to a service (port) in the intranet from outside must be defined in advance by specifying a port number. The destination port is specified with the intranet address of, for example, the FTP server, in a service table to achieve this.
- When accessing the Internet from the LAN, on the other hand, the router itself makes the entry in the port and IP address information table.

! The table concerned can hold up to 2048 entries, that is it allows 2048 **simultaneous** transmissions between the masked and the unmasked network.

After a specified period of time, the router, however, assumes that the entry is no longer required and deletes it automatically from the table.

! **Stateful Inspection and inverse masquerading:** If in the Masquerading module a port is exposed (i.e. all packets received on this port should be forwarded to a server in the local area network), then this requires with a Deny All Firewall strategy an **additional** entry in the Stateful Inspection Firewall, which enables the access of all stations to the respective server.

On occasion it is desirable for the "exposed" host not to be contacted over this standard port, e.g. when security reasons demand the use of another port.

In this case not only the implementation of ports to an IP address is necessary, but as well the implementation to other ports (port mapping). Another example of use for this port implementation is the implementation of several ports of the WAN to a shared port in the LAN, which can be assigned to different IP addresses (N-IP-Mapping).

The configuration of port mapping involves the assignment of a port or port range (start port to end port) to an IP address from the LAN as the target and the port (map port) to be used in the LAN.

LANconfig: IP-Router / Masquerading / Port-Forwarding table

WEBconfig: LCOS-menu tree / Setup / IP-Router / 1-N-NAT / Service table

- Start port

D-port from (start port)

- End port

D-port to (end port)

- Remote site

Remote site which applies for this entry.

- The use of virtual routers requires for the port forwarding a specific selection of the remote station. If no peer is entered then the entry applies to all peers.

- Intranet-Adresse

Internet address that a packet within the port range is forwarded to.

- Map port

Port used for forwarding the packet.



If "0" is entered for the map port, the ports used in the LAN will be the same as those used in the WAN. If a port range is to be mapped, then the map port identifies the first LAN port to be used. For example, mapping the port range '1200' to '1205' to the internal map port '1000' means that the ports 1000 to 1005 will be used for data transfer in the LAN.



Port mapping is static, meaning that two ports or port ranges cannot be mapped to the same map port of a target computer in the LAN. The same port mapping can be used for different target computers.

- Protocol

Protocol which applies for this entry.

- WAN address

WAN address which applies for this entry. If the device has more than one static IP address, then this allows port forwarding to be limited to certain connections.

- Entry active

Switches the entry on or off.

- Comment

Comment on the defined entry (64 characters)

## 7.6 Demilitarized Zone (DMZ)

A demilitarized zone (DMZ) makes certain stations in a network accessible from the Internet. These computers in the DMZ are generally used to offer Internet services such as e-mail or similar services. The rest of the network should of course be unaccessible for attackers on the Internet.

In order to allow this architecture, data traffic between the three zones Internet, DMZ and LAN must be analyzed by a firewall. The firewall's tasks can also be consolidated in a single device (router). For this, the router needs three interfaces that can be monitored separately from each other by the firewall:

- LAN interface
- WAN interface
- DMZ interface

! The table lists which devices support this functionality.

### 7.6.1 Assigning interfaces to the DMZ

To configure the DMZ the corresponding interface is defined as the DMZ interface.

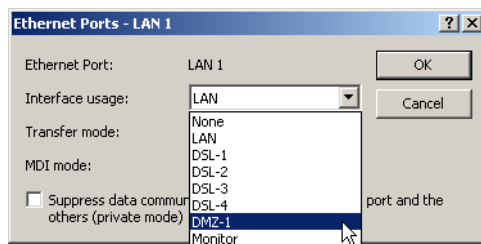

LANconfig: Interfaces / LAN / Ethernet-Ports

WEBconfig: LCOS-menu tree / Setup / Interfaces / LAN

## 7.6.2 Assigning network zones to the DMZ

Various network zones (address ranges) are assigned to the DMZ and the LAN using the address settings. Depending on availability, WLAN interfaces can also be selected.

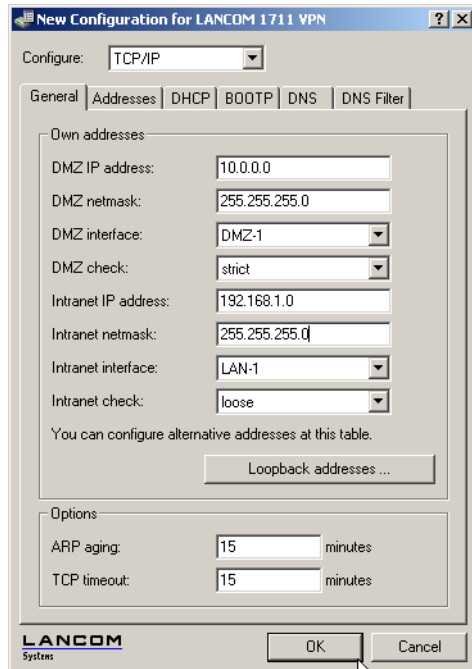

LANconfig: TCP/IP / General

WEBconfig: LCOS-menu tree / Setup / TCP-IP

## 7.6.3 Address check with DMZ and intranet interfaces

To shield the DMZ (demilitarized zone) and the Intranet from unauthorized attacks, you can activate an additional address check for each interface using the firewall's Intrusion Detection System (IDS).

The relevant buttons are called 'DMZ check' or 'Intranet check' and can have the values 'loose' or 'strict':

- If the button is set to 'loose', then every source address is accepted if the LANCOM is addressed directly.
- If the switch is set to 'strict', then a return route has to be explicitly available so that no IDS alarm is triggered. This is usually the case if the data packet contains a sender address to which the relevant interface can also route data. Sender addresses from other networks, to which the interface cannot route, or sender addresses from the own address range will therefore trigger an IDS-alarm.

! For all devices, the default is 'loose'. The default is set to 'strict' for LANCOM 7011 VPN only, as a more precise address check has already been used for this device.

You will find the button for activating the DMZ and Intranet address check in LANconfig in the 'TCP-IP' configuration area on the 'General' tab page.

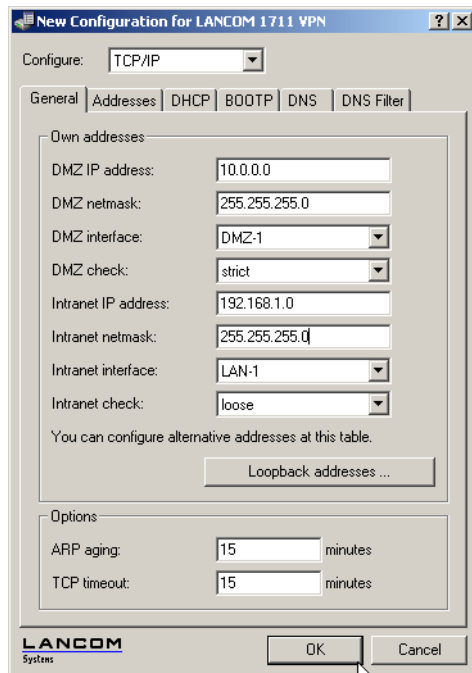

LANconfig: TCP/IP / General

WEBconfig: LCOS-menu tree / Setup / TCP-IP

## 7.6.4 Unmasked Internet access for server in the DMZ

While the inverse masquerading described in the preceding paragraph allows to expose at least one service of each type (e.g. one Web, Mail and FTP server), this method is bound to some restrictions.

- The masquerading module must support and 'understand' the particular server service of the 'exposed host'. For instance, several VoIP servers use proprietary, non-standard ports for extended signalling. Thus such server could be used on unmasked connections solely.
- From a security point of view, it must be considered that the 'exposed host' resides within the LAN. When the host is under control of an attacker, it could be misused as a starting point for further attacks against machines in the local network.

! In order to prevent attacks from a cracked server to the local network, some LANCOM provide a dedicated DMZ interface (LANCOM 7011 VPN) or are able to separate their LAN ports on Ethernet level by hardware (LANCOM 821 ADSL/ISDN, LANCOM 1511 DSL, LANCOM 1521 ADSL, LANCOM 1621 ADSL/ISDN, LANCOM 1711 VPN, LANCOM 1811 DSL and LANCOM 1821 ADSL).

### Two local networks - operating servers in a DMZ

This feature requires an Internet access with multiple static IP addresses. Please contact you ISP for an appropriate offer.

Example: You are assigned the IP network address 123.45.67.0 with the netmask 255.255.255.248 by your provider. Then you can assign the IP addresses as follows:

DMZ IP address	Meaning/use
123.45.67.0	network address
123.45.67.1	LANCOM as a gateway for the Intranet

DMZ IP address	Meaning/use
123.45.67.2	Device in the LAN which is to receive unmasked access to the Internet, e.g. web server connected at the DMZ port
123.45.67.3	broadcast address

All computers and devices in the Intranet have no public IP address, and therefore appear with the IP address of the LANCOM (123.45.67.1) on the Internet.

### Separation of Intranet and DMZ

! Although Intranet and DMZ may be already separated on a Ethernet level by distinct interfaces, an appropriate Firewall rule must be set up in any case so that the DMZ is being separated from the LAN on the IP level as well.

Thereby, the server service shall be available from the Internet and from the Intranet, but any IP traffic from the DMZ towards the Intranet must be prohibited. For the above example, this reads as follows:

- With a 'Allow All' strategy (default): Deny access from 123.45.67.2 to "All stations in local network"
- With a 'Deny All' strategy : Allow access from "All stations in local network" to 123.45.67.2

## 7.7 Multi-PPPoE

In most cases just one connection at a time is established over a DSL or ADSL WAN interface. However, there are applications where it makes sense to use multiple parallel connections on the WAN interface. LANCOM devices with a DSL or ADSL interface can establish up to eight different channels in parallel in the WAN using the same physical interface.

### 7.7.1 Example application: Home-Office with private Internet access

One possible application is the home office used by sales personnel who need access to the network at the headquarters via a VPN connection. The company pays for the VPN connection, the employee in the home office pays for Internet access privately.

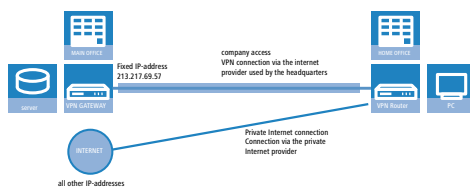

To ensure a clean separation of the data links, two Internet connections are established, one to each provider. In the IP routing table, the default route is assigned to the private provider; the network with the headquarters via the VPN connection is routed over the headquarters' provider.

### 7.7.2 Configuration

The configuration of this scenario involves the following steps with the home-office router:

- Configuration of the private Internet access, for example with the LANconfig Wizard or with WEBconfig.
- Configuration of the Internet access that is invoiced to the headquarters.
- Selection of the private provider for the default route in the IP routing table (e.g. manually with LANconfig or with the Wizard for selecting Internet providers in WEBconfig).
- Configuration of the VPN connection to the network at the headquarters.
- Allocation of the VPN connection to the headquarters' provider.



To ensure that the data traffic for the headquarters is routed via the desired Internet provider, one more entry in the IP routing table is required. Here, the VPN gateway at the headquarters is entered along with its fixed IP address and appropriate netmask, and is forwarded to the remote site used by the headquarters' provider.

- ⚠ It is important that the route to the Internet provider used by the headquarters is masked; otherwise the LANCOM would apply the LAN address and not the WAN address, and the connection would never be established.

Further information about these steps in the configuration are to be found in the documentation for your LANCOM device.

- ⚠ **Administrator rights for the employee in the home office:** To avoid the employee making accidental changes to the settings for the Internet provider or VPN access, he should be assigned with the WEBconfig function rights for the "Internet connection" and "Selection of Internet provider" Wizards only. Information about the configuration of special user rights can be found in this addendum under .

- ⚠ Use the necessary filter rules in the area 'Firewall/QoS' to ensure that the Internet traffic is not accidentally directed via the network at the headquarters.

## 7.8 Load balancing

Despite the ever increasing bandwidth of DSL connections, these remain the communications bottle-neck. In some cases it can be advisable to combine multiple DSL connections. There are a number of possibilities to realize this, some of which need active support from the Internet provider:

- DSL channel bundling (Multilink-PPPoE – MLPPPoE)

The availability of direct bundling depends on the Internet provider's product range. If available, the user has access to the sum of the bandwidths of all of the bundled channels. Multilink-PPPoE can also be used for bundling PPP connections.

- ⚠ This version of channel bundling provides bandwidths that are a multiple of the smallest bundled channel. This means that it is especially efficient when channels are all of the same bandwidth. The direct bundling of different bandwidths means that the channels with the higher data rates suffer from a loss in effective bandwidth.

When bundling MLPPPoE for DSL channels behaves in the same way as the well known MLPPP for ISDN channel bundling.

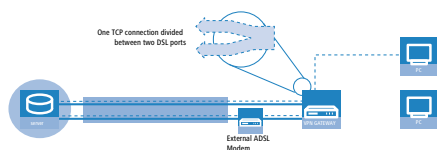

- Load balancing

Load balancing involves the dynamic division of TCP connections between independent DSL connections. The user has access to the sum of the bandwidths of the bundled channels, but the individual TCP connections are limited to the bandwidth offered by the DSL connection allocated to it.

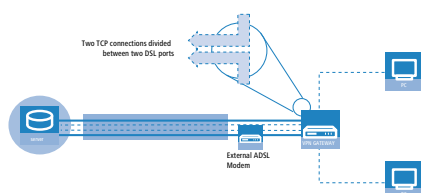

- ⚠ Unlike direct channel bundling, load balancing offers the true sum of all bundled bandwidths. This version is thus highly effective for combining different bandwidths.

### 7.8.1 DSL port mapping

A basic requirement for DSL channel bundling is the support of more than one DSL interface per device. This means that one or more external DSL modems are connected to the switch of a LANCOM router.

- ⚠ Please refer to the feature table in the appendix to see if your device supports the connection of external DSL modems.

#### Allocation of switch ports to the DSL ports

Depending on the model, devices with an integrated switch can enable some of the LAN ports to be used as additional WAN ports for connecting to external DSL modems. These ports are listed in the interface table as separate DSL interfaces (DSL-1, DSL-2, etc.). The DSL ports are activated as DSL interfaces in the WAN interfaces list, configured with the up- and downstream rates and allocated to the switch ports in the LAN interfaces list (example: LANCOM Wireless 1811DSL)

Port	Allocation	Connections	MDI mode	Private mode
LAN -1	LAN -1	Auto	Auto	No
LAN -2	LAN -1	Auto	Auto	No
LAN -3	LAN -1	Auto	Auto	No
LAN -4	LAN -1	Auto	Auto	No
WAN	DSL-1	Auto	Auto	No

- The column 'Port' contains the description of the associated port as marked on the back cover of the device.
- The utilization of the port is listed in the column 'Allocation':
  - None: The port is deactivated
  - LAN-1: The port is allocated to the LAN
  - DSL-1, DSL-2, ... : The port is allocated to one of the DSL interfaces
  - Monitor: The port is a monitor port, i.e. everything received at the other ports is output via this port. A packet sniffer such as Ethereal can be connected to this port, for example.

The allocation of DSL ports to the Ethernet ports can be chosen freely. A well-arranged assignment can be achieved by assigning the DSL ports in reversed order to the ports on the switch (for example: LANCOM Wireless 1811 DSL):

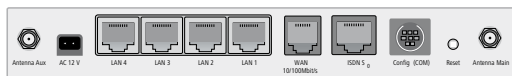

1. LAN4 / DSL-2
2. LAN3 / DSL-3
3. LAN2 / DSL-4
4. LAN1 / LAN-1: This port remains reserved for the LAN.
5. WAN / DSL-1: (dedicated WAN port for the device)

If the device is equipped with more than one DSL port, the DSL port to be used is entered in the DSL-Broadband-Peers list:

1. If no port is defined (or port "0"), the LANCOM selects the port after the one chosen for the connection's communication layer.
  - If Layer-1 is set with 'AAL-5', then the ADSL interface is chosen.
    - If Layer-1 is set with 'ETH', then the first DSL port (i.e. DSL-1) is chosen.

- If a particular port is defined (not "0"), then it will be used for the connection.

 Observe that the communication layer set for the connection over this port in Layer 1 is set to 'ETH'.

- To enable channel bundling via multiple DSL interfaces, the appropriate ports are entered into the peer list for the remote station (as a comma-separated port list '1,2,3' or as a port range '1-3'). With a port list, the bundled channels will be established in the given order; only in case of error will the channels be tested in ascending order. With a port range, the channels are always established in ascending order.
  - In the list of Ethernet ports, the ports must be switched to DSL port.
  - The DSL ports have to be activated as DSL interfaces in the list of the WAN interfaces and need to be configured with the correct up- and downstreams.
  - In the layer used for the connection, a bundling method has to be activated that is also supported at the remote site.
  - To configure channel bundling for an internal ADSL interface, the ADSL port '0' is entered into the list of ports **at the top of the list** (e.g. '0,1,2,3' as port list or '0-3' as port range). In the remote device, the communications layer must be set to Layer 1 'AAL-5'.

 An entry in the peer list can contain various ports (e.g. ADSL and Ethernet), but it can only reference **one** communications layer in which just **one** layer-1 protocol can be defined. For bundled communications over ADSL and Ethernet ports, however, **two** different layer-1 protocols are required. For this reason, layer 1 is set to 'AAL-5' in these cases. As only one ADSL interface can exist in the devices, all of the interfaces bundled into this are automatically changed to layer 1 with 'ETH' for Ethernet DSL ports. This automatic change of the layer can only succeed if the ADSL interface is the first one to be selected for bundled connections.

- For devices with a built-in ADSL modem and an additional Ethernet interface (DSL or DSLoL), it is clear which ports are used for bundling. In this case it is not necessary to enter the ports into the remote site list. These devices always internally assume a port list '0,1' so that the internal ADSL interface is the first one to be used for bundling.

 For Multi-PPPoE, multiple PPPoE connections share one physical DSL connection. With Multi-DSL, several PPPoE connection are divided between the available DSL interfaces. The maximum possible number of parallel connections is limited to 8 channels.

### Allocation of MAC addresses to the DSL ports

If a LANCOM uses switch ports to gain access to multiple DSL (WAN) interfaces, an appropriate number of MAC addresses must be used to differentiate the DSL ports. As there are cases where the required MAC address depends upon the remote site which, for example, uses the MAC address to determine the DSL access charge, the MAC addresses are defined for the logical DSL remote sites and not for the physical DSL ports.

The following options are available for setting the MAC address:

- Global: Global system MAC address
- Local: The unique, locally managed MAC address is calculated from the global address
- User defined: A MAC address that can be freely defined by the user

 Every DSL connection contains its own MAC address. If two remote stations are configured with identical MAC addresses, the first connection uses the configured MAC address. For the second connection a "locally managed", unambiguous MAC address will be calculated from the user-defined MAC address.

When using channel bundling, the configured MAC address is used for the first connection, for all other bundle connections the locally managed MAC addresses based on the user-defined MAC address will be calculated.

If one of your connections is charged via the MAC address, configure this MAC address for the separately charged connection only. For all other connections you should use another address.

## 7.8.2 DSL-channel bundling (MLPPoE)

The used DSL ports are registered in the list of the DSL broadband remote stations to bundle DSL links. Therefore the number of the DSL port is indicated, for several ports in a by comma separated list (1,2,4) or as a region (1-4).

All that is required for PPPoE bundling is to activate bundling in the relevant layer and to use the port list to assign the relevant ports.

## 7.8.3 Dynamic load balancing

If the Internet provider does not directly support bundling, then multiple normal DSL connections can be coupled with a load balancer. First of all, the DSL accesses are set up for the necessary DSL ports. These are then coupled with a load-balancing table. This list assigns a virtual balancing connection (the connection that is entered into the routing table) to the other real DSL connections (bundle connections). Depending on the number of available DSL ports, several bundle connections can be assigned to one balancing connection.

! The balancing connection is entered as a "virtual" connection. No access data or similar has to be entered for this connection. The entry merely serves as a "distributor" which uses the load-balancing table to assign several "real" bundled connections to an entry in the routing table.

! DSL bundling is a static bundling. Any additional channels are **not** opened or closed according to the demand from data transfer volumes.

With load balancing, decisions about the routing of data packets can no longer be made simply based on the IP addresses because the individual bundled DSL connections all have different IP addresses. Thus load balancing also considers the information in the firewall connection list. This list has an entry for every established TCP connection, and for load balancing the list is supplemented with information about the DSL port used.

### Connection establishment

A request for data transmission to a balancing remote site initially prompts the **first** bundle connection from the load balancing table to be established. Further progress depends upon the success of this connection establishment:

- If the connection is successfully established, the first step is the assignment of all pending TCP connections to this channel. Subsequently, all of the configured bundle connections will successively be established. As soon as at least two bundle connections are active, new TCP connections will be divided among the active bundle connections.
- Should establishment of the bundling connection fail, then attempts will be made to establish other bundle connections one after the other. As soon as one of the bundle connections is established, all of the pending TCP connections will be directed to this channel.

### Spreading the data load

Two basic methods are available for balancing the data load:

- If the channel's bandwidth is known, then the connections will be assigned to the channel with the lowest workload (in percent).
- If the bandwidth is not known, then a differentiation is made according to the type of connection required; a TCP connection; or VPN or PPTP connections from the LANCOM.
  - If a TCP connection requests a channel, then the one with the lowest absolute workload will be chosen.
  - If a VPN or PPTP connection requests a channel, then the connections will be equally spread between all available channels.

! For the most effective use of load balancing, the bandwidth should be entered into the list of WAN interfaces under LANconfig in the configuration area 'Interface' on the 'WAN' tab under the button **Interface settings** (Telnet: /Setup/Interfaces/DSL, WEBconfig: **LCOS menu tree / Setup / Interfaces / DSL**).

## 7.8.4 Static load balancing

Apart from the dynamic choice of connection outlined in the previous section, there are possible scenarios where certain TCP connections should always make use of the same DSL connection. Two cases are to be considered here:

- A server with a fixed IP address can only be contacted via a dedicated connection. All that is required for the selection here is the destination IP address.
- A server uses a protocol that requires a control channel and other channels for data transfer (e.g. FTP, H.323, PPTP). In establishing the data channels, servers accept only the same IP address as used by the control channel.

### Destination-based channel selection

Destination-based channel selection is handled by an entry in the routing table that directly uses one of the bundle connections to reach the destination instead of using the virtual balancing connection.

### Policy-based Routing

Suitable entries can be made in the firewall to select channels according to the destination port or the source address. These entries are supplemented with a special routing tag that is used to control the channel selection with the routing table. Please refer to for further information.

## 7.8.5 Configuration of load balancing

! For the following configurations we assume that the remote devices are already set up with all necessary access data.

### Direct channel bundling via PPPoE

The following method is for the configuration of channel bundling via PPPoE:

1. Assign the DSL ports to the required Ethernet ports, in LANconfig via **Interfaces / LAN / Ethernet-Ports**. Telnet: `/Setup/Interfaces/Ethernet-ports` WEBconfig: **LCOS menu tree / Setup / Interfaces / Ethernet ports**
2. Activate the additional DSL interfaces in LANconfig via **Interfaces / WAN / Interface settings**. Enter the data rates for up- and downstream. Telnet: `/Setup/Interfaces/DSL` WEBconfig: **LCOS menu tree / Setup / Interfaces / DSL**
3. For the required remote site, enter the DSL ports that are to be used in LANconfig via **Communication / Remote sites / Remote sites (DSL)**. Telnet: `/Setup/WAN/DSL-broadband-peers` WEBconfig: **LCOS menu tree / Setup / WAN / DSL broadband peers**
4. Activate channel bundling for the relevant layers in LANconfig via **Communication / General / Communication layers**. Telnet: `/Setup/WAN/Layer` WEBconfig: **LCOS menu tree / Setup / WAN / Layer**

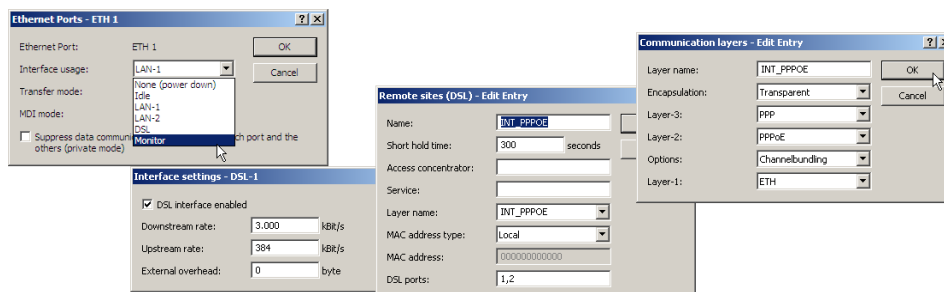

### Dynamic load balancing with multiple DSL connections

The first step in setting up dynamic load balancing is to define the Internet accesses, e.g. 'INET1' and 'INET2', with the aid of the LANconfig Wizard.

- To distribute Internet traffic across different DSL interfaces, the individual remote sites are assigned to different DSL ports in LANconfig under **Communication / Remote sites / Remote sites (DSL)**. Telnet: /Setup/WAN/DSL-broadband-peers WEBconfig: **LCOS menu tree / Setup / WAN / DSL broadband peers**

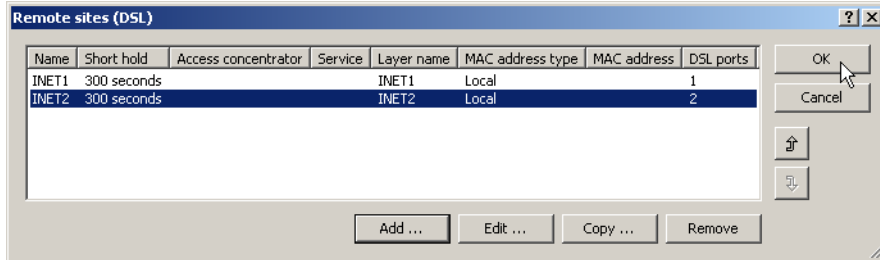

- The two DSL remotes are assigned to a new virtual remote site 'INTERNET' in the load balancing list in LANconfig via **IP router / Routing / Load balancing**. Telnet: /Setup/IP-router/Load-balancer WEBconfig: **LCOS menu tree / Setup / IP router / Load balancer**

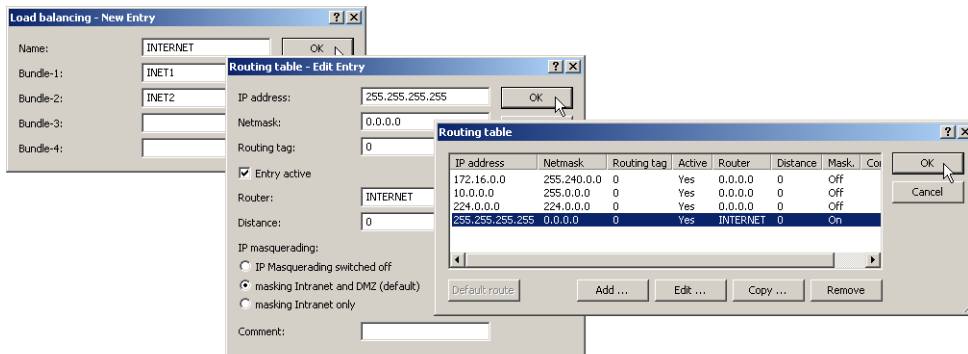

- The virtual remote site is entered into the routing table as the router for the default route in LANconfig via **IP router / Routing / Routing table**. Telnet: /Setup/IP-router/IP-routing-table WEBconfig: **LCOS menu tree / Setup / IP router / IP routing table**

**!** The virtual remote site 'INTERNET' is now to be used for Internet access. When data are routed over this connection, the load balancing table will cause the "real" DSL connections to be established and the data will be transmitted over the selected DSL ports.

Routing tags can be used for the application-dependent direction of data traffic to specific DSL ports. If i.e outbound E-Mail traffic ought to be routed via a particular DSL-interface with a particular IP-address, a fitting rule must be established via LANconfig under **Firewall/QoS / Rules**, which reroutes all data traffic of all local station's E-Mail services to the mail server and sets the routing tag '1'.

Telnet: /Setup/IP-router/Firewall/Rules WEBconfig: **LCOS menu tree / Setup / IP router / Firewall/ Rules**.

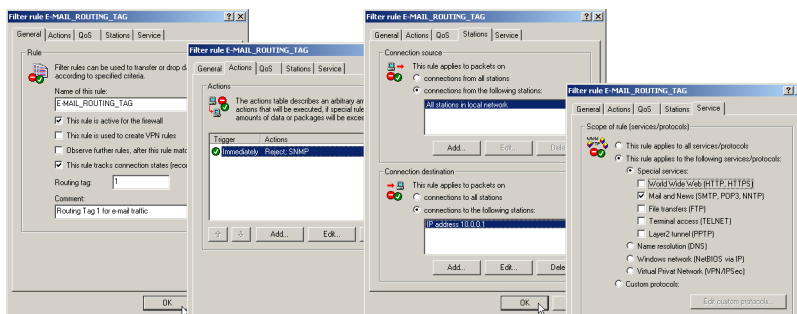

## 7.9 N:N mapping

Network Address Translation (NAT) can be used for several different matters:

- for better utilizing the IP4 addresses ever becoming scarcer
- for coupling of networks with same (private) address ranges
- for producing unique addresses for network management

In the first application the so-called N:1 NAT, also known as IP masquerading is used. All addresses ("N") of the local network are mapped to only one ("1") public address. This clear assignment of data streams to the respective internal PCs is generally made available by the ports of the TCP and UDP protocols. That's why this is also called NAT/PAT (Network Address Translation/Port Address Translation).

Due to the dynamic assignment of ports, N:1 masquerading enables only those connections, which have been initiated by the internal network. Exception: an internal IP address is statically exposed on a certain port, e.g. to make a LAN server accessible from the outside. This process is called "inverse masquerading".

A N:N mapping is used for network couplings with identical address ranges. This transforms unambiguously multiple addresses ("N") of the local network to multiple ("N") addresses of another network. Thereby, an address conflict can be resolved.

Rules for this address translation are defined in a static table in the LANCOM. Thereby new addresses are assigned to single stations, parts of the network, or the entire LAN, by which the stations can contact other networks then.

Some protocols (FTP, H.323) exchange parameters during their protocol negotiation, which can have influence on the address translation for the N:N mapping. For a correct functioning of the address translation, the connection information of these protocols are tracked appropriately by functions of the firewall in a dynamic table, and are additionally considered to the entries of the static table.

**!** The address translation is made "outbound", i.e. the source address is translated for outgoing data packets and the destination address for incoming data packets, as long as the addresses are located within the defined translation range. An "inbound" address mapping, whereby the source address is translated (instead of the destination address), needs to be realized by an appropriate "outbound" address translation on the remote side.

### 7.9.1 Application examples

The following typical applications are described in this section:

- Coupling of private networks utilizing the same address range
- Central remote monitoring by service providers

#### Network coupling

An often appearing scenario is the coupling of two company networks which internally use the same address range (e. g. 10.0.0.x). This is often the case, when one company should get access to one (or more) server(s) of the other one:

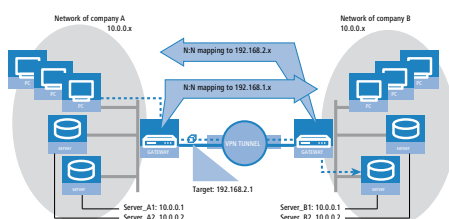

In this example network servers of company A and B should have access over a VPN tunnel to the respective other network. All stations of the LAN should have access to the server of the remote network. For the time being, there is no access possible to the other network, because both networks use the same address range. If one station of the network

of company A wants to access server 1 of company B, the addressee (with an address from the 10.0.0.x network) will be searched within the own local network, and the inquiry even does not reach the gateway.

With the help of N:N mapping, all addresses of the LAN can be translated to a new address range for the coupling with the other network. The network of company A e. g. will be translated to 192.168.1.x, the network of company B to 192.168.2.x. Under these new addresses the two LANs are now reachable for the respective other network. The station from the network of company A is now addressing server 1 of company B under the address 192.168.2.1. The addressee does not reside any more within the own network, the inquiry is now passed on to the gateway, and the routing to the other network is working as desired.

## Remote monitoring and remote control of networks

Remote maintenance and control of networks become more and more important because of the possibilities given by VPN. With the use of the nearly ubiquitous broadband Internet connections, the administrator of such management scenarios is no longer dependent of the different data communication technologies or expensive leased lines.

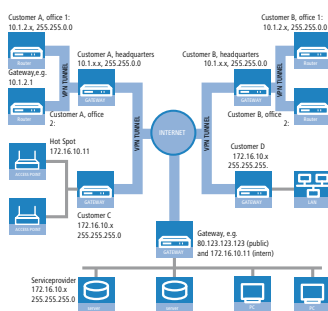

In this example, a service provider monitors the networks of different clients out of a central control. For this purpose, the SNMP-capable devices should send the respective traps of important events automatically to the SNMP trap addressee (e. g. LANmonitor) of the network of the service provider. So the LAN administrator of the service provider has an up-to-date view of the state of the devices at any time.

The individual networks can be structured very differently: Clients A and B integrate their branches with own networks via VPN connections to their LAN, client C operates a network with several public WLAN base stations as hot spots, and client D has got an additional router for ISDN dial-up accesses in his LAN.

! The networks of client A and B use different address ranges in the respective head office and the connected branches. A standard network coupling via VPN is therefore possible between these networks.

In order to avoid the effort to building up its own VPN tunnel to each individual subnetwork of the clients A and B, the service provider makes only one VPN connection to the head office, and uses the existing VPN lines between head office and branches for communication with the branches.

Traps from the networks report to the service provider whether e. g. a VPN tunnel has been build up or cut, if an user has been tried to log in three times with a wrong password, if an user has been applied for a hot spot, or if somewhere a LAN cable has been pulled out of a switch.

! A complete list of all SNMP traps supported by LANCOM can be found in the appendix of this reference manual.

Routing of these different networks reaches very fast its limiting factors, if two or more clients use same address ranges. Additionally, if some clients use the same address range as the service provider as well, further address conflicts are added. In this example, one of the hot spots of client C has got the same address as the gateway of the service provider.

There are two different variants to resolve these address conflicts:

- In the decentralized variant, alternative IP addresses for communicating with the SNMP addressee are assigned to each of the monitored devices by means of an 1:1 mapping. This address is in technical language also known as "loopback address", the method accordingly as "loopback method".



- 
- ❗ The loopback addresses are valid only for communication with certain remote stations on the connections belonging to them. Thus a LANCOM is not generally accessible via this IP address.
  - Even more appealing is the solution of a central mapping: instead of configuring each single gateway in the branch networks, the administrator configures solely one central address translation in the gateway of the head office. On this occasion, also all subnetworks located "behind" the head office are supplied with the needed new IP addresses.

In this example, the administrator of the service provider selects 10.2.x.x as central address translation for the network of client B, so that both networks with actual same address range looks like two different networks for the gateway of the service provider.

The administrator selects the address ranges 192.168.2.x and 192.168.3.x for client C and D, so that the addresses of these networks do differ from the own network of the service provider.

In order to enable the gateway of the provider to monitor the networks of clients C and D, the administrator sets up an address translation to 192.168.1.x also for the own network.

## 7.9.2 Configuration

### Setting up address translation

Configuration of N:N mapping succeeds with only few information. Since a LAN can be coupled with several other networks via N:N, different destinations can have also different address translations for a source IP range. The NAT table can contain 64 entries at maximum, including the following information:

- **Index:** Unambiguous index of the entry.
- **Source address:** IP address of the workstation or network that should get an alternative IP address.
- **Source mask:** Netmask of source range.
- **Remote station:** Name of the remote station over that the remote network is reachable.
- **New network address:** IP address or address range that should be used for the translation.

For the new network address, the same netmask will be used as the source address already uses. For assignment of source and mapping addresses the following hints apply:

- Source and mapping can be assigned arbitrarily for the translation of single addresses. Thus, for example, it is possible to assign the mapping address 192.168.1.88 to a LAN server with the IP address 10.1.1.99.
- For translation of entire address ranges, the station-related part of the IP address will be taken directly, only appended to the network-related part of the mapping address. Therefore, in an assignment of 10.0.0.0/255.255.255.0 to **192.168.1.0**, a server of the LAN with IP address 10.1.1.99 will get assigned the mapping address 192.168.1.99.

---

❗ The address range for translation must be at minimum as large as the source address range.

---

❗ Please notice that the N:N mapping functions are only effective when the firewall has been activated.

### Additional configuration hints

By setting up address translation in the NAT table, the networks and workstations become only visible under another address at first in the higher network compound. But for a seamless routing of data between the networks some further settings are still necessary:

- Entries in the routing tables for packets with new addresses to find the way to their destination.
- DNS forwarding entries, in order that inquiries about certain devices in the respective other networks can be resolved into mapped IP addresses.
- The firewall rules of the gateways must be adjusted such that (if necessary) authorized stations resp. networks from the outside are permitted to set up connections.
- VPN rules for loopback addresses in order to transmit the newly assigned IP addresses through an according VPN tunnel.

! The IP address translation takes place in the LANCOM between firewall and IP router on one hand, and the VPN module on the other hand. All rules related to the own network use therefore the "unmapped" original addresses. The entries of the remote network use the "mapped" addresses of the remote side, valid on the VPN connection.

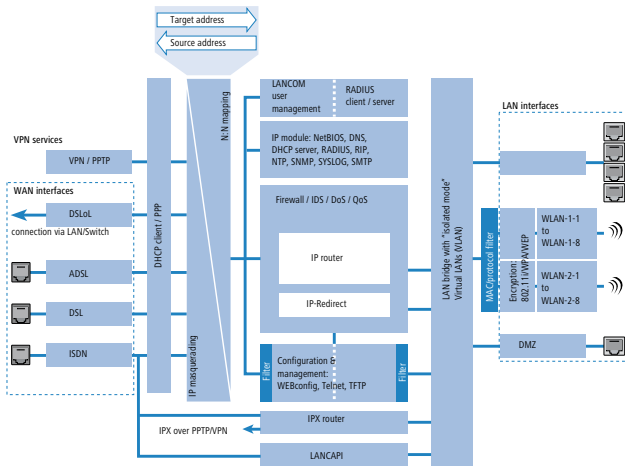

### Configuration with different tools

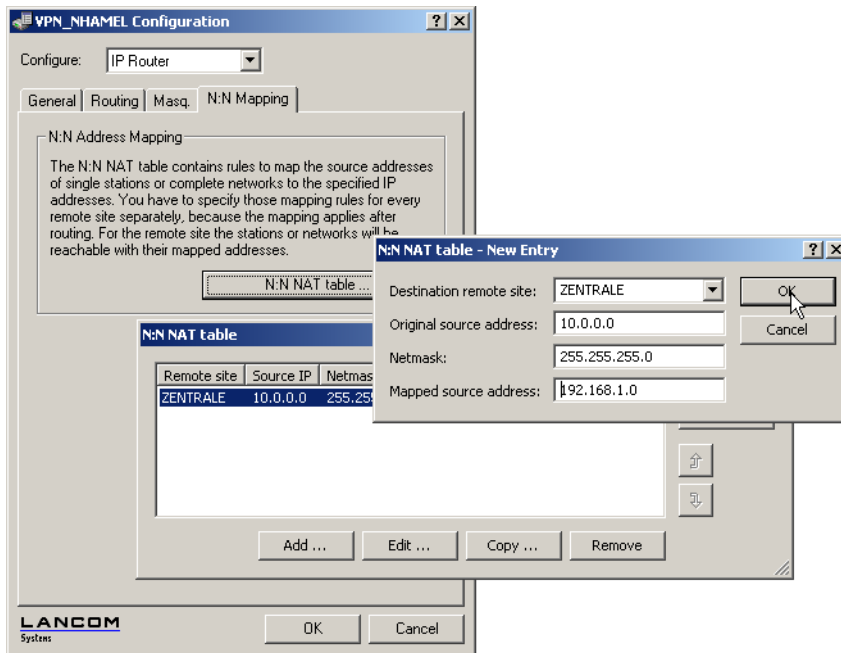

LANconfig: IP router / N:N-Mapping

WEBconfig: LCOS menu tree / Setup / IP router / NAT table

When starting a new entry under WEBconfig, the NAT table shows up as follows:

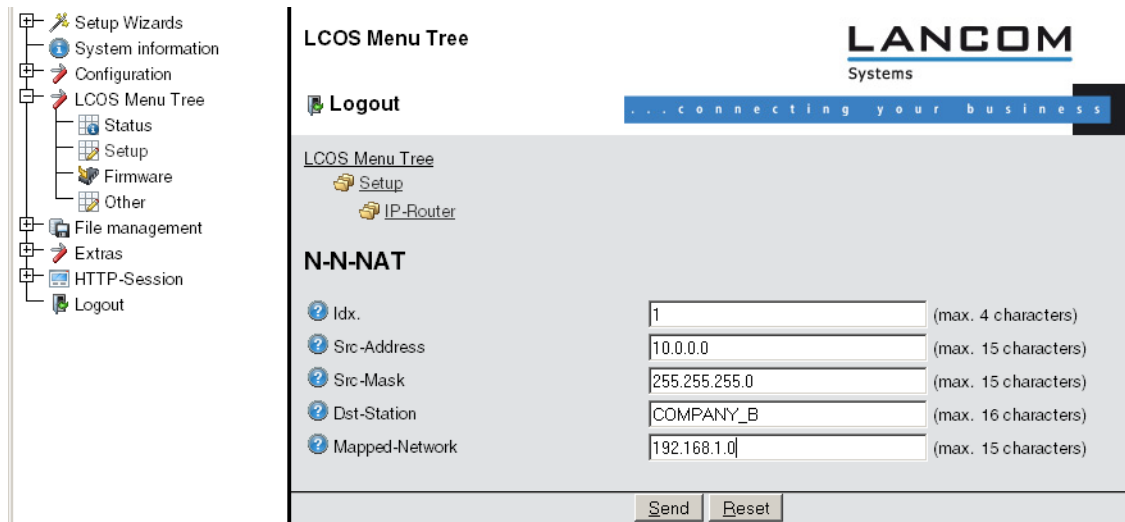

## 7.10 Establishing connection with PPP

LANCOM Systems routers also support the point-to-point protocol (PPP). PPP is a generic term for a whole series of WAN protocols which enable the interaction of routers made by different manufacturers since this protocol is supported by practically all manufacturers.

Due to the increasing importance of this protocol family and the fact that PPP is not associated with any specific operating mode of the routers, we will be introducing the functions of the devices associated with the PPP here in a separate section.

### 7.10.1 The protocol

#### What is PPP?

The point-to-point protocol was developed specifically for network connections via serial channels and has asserted itself as the standard for connections between routers. It implements the following functions:

- Password protection according to PAP, CHAP or MS CHAP
- Callback functions
- Negotiation of the network protocol to be used over the connection established (IP or IPX, for example). Included in this are any parameters necessary for these protocols, for example IP addresses. This process is carried out using IPCP (IP Control Protocol).
- Negotiation of the connection parameters, e.g. the MTU (Maximum Transmission Unit, ).
- Verification of the connection through the LCP (Link Control Protocol)
- Combining several ISDN or DSL channels (MultiLink PPP resp. MultiLink PPPoE)

PPP is the standard used by router connections for communication between devices or the WAN connection software of different manufacturers. Connection parameters are negotiated and a common denominator is agreed using standardized control protocols (e.g. LCP, IPCP, CCP) which are contained in PPP, in order to ensure successful data transfer where possible.

#### What is PPP used for?

It is best to use the point-to-point protocol in the following applications:

- for reasons of compatibility when communicating with external routers, for example
- remote access from remote workstations with ISDN cards
- Internet access (when sending addresses)

The PPP which is implemented by LANCOM can be used synchronously or asynchronously not only via a transparent HDLC connection, but also via an X.75 connection.

### The phases of PPP negotiation

Establishment of a connection using PPP always begins with a negotiation of the parameters to be used for the connection. This negotiation is carried out in four phases which should be understood for the sake of configuration and troubleshooting.

- Establish phase

Once a connection has been made at the data communication level, negotiation of the connection parameters begins through the LCP.

This ascertains whether the remote site is also ready to use PPP, and the packet sizes and authentication protocol (PAP, CHAP, MS-CHAP or none) are determined. The LCP then switches to the opened state.

- Authenticate phase

Passwords will then be exchanged, if necessary. The password will only be sent once if PAP is being used for the authentication process. An encrypted password will be sent periodically at adjustable intervals if CHAP or MS CHAP is being used.

Perhaps a callback is also negotiated in this phase via CBCP (Callback Control Protocol).

- Network phase

LANCOM, supports the protocols IPCP and IPXCP.

After the password has been successfully transmitted, the IPCP and/or IPXCP network layer can be established.

IP and/or IPS packets can be transferred from the router modules to the opened line if the negotiation of parameters is successful for at least one of the network layers.

- Terminate phase

In the final phase the line is cleared, when the logical connections for all protocols are cleared.

### PPP negotiation in the LANCOM

The progress of a PPP negotiation is logged in the devices' PPP statistics and the protocol packets listed in detail there can be used for checking purposes in the event of an error.

The PPP trace outputs offer a further method of analysis. You can use the command

- `trace + ppp`

to begin output of the PPP protocol frames exchanged during a terminal session. You can perform a detailed analysis once the connection has been broken if this terminal session has been logged in a log file.

## 7.10.2 Everything o.k.? Checking the line with LCP

The devices involved in the establishment of a connection through PPP negotiate a common behavior during data transfer. For example, they first decide whether a connection can be made at all using the security procedure, names and passwords specified.

The reliability of the line can be constantly monitored using the LCP once the connection has been established. This is achieved within the protocol by the LCP echo request and the associated LCP echo reply. The LCP echo request is a query in the form of a data packet which is transferred to the remote station along with the data. The connection is reliable and stable if a valid response to this request for information is returned (LCP echo reply). This request is repeated at defined intervals so that the connection can be continually monitored.

What happens when there is no reply? First a few retries will be initiated to exclude the possibility of any short-term line interference. The line will be dropped and an alternative route sought if all the retries remain unanswered. If, for example, the high-speed connection refuses to work, an existing ISDN port can open the way to the Internet as a backup.

- ⓘ During remote access of individual workstations with Windows operating systems, we recommend switching off the regular LCP requests since these operating systems do not reply to LCP echo requests.
- ⓘ The LCP request behavior is configured in the PPP list for each individual connection. The intervals at which LCP requests should be made are set by the entries in the 'Time' and 'Retr.' fields, along with the number of retries that should be initiated without a response before the line can be considered faulty. LCP requests can be switched off entirely by setting the time at '0' and the retries at '0'.

### 7.10.3 Assignment of IP addresses via PPP

In order to connect computers using TCP/IP as the network protocol, all participating computers require a valid and unique IP address. If a remote station does not have its own IP address (such as the individual workstation of a telecomputer), the LANCOM assigns it an IP address for the duration of the connection, enabling communications to take place.

This type of address assignment is carried out during PPP negotiation and implemented only for connections via WAN. In contrast, the assignment of addresses via DHCP is (normally) used within a local network.

- ⓘ Assignment of an IP address will only be possible if the LANCOM can identify the remote station by its call number or name when the call arrives, i.e. the authentication process has been successful.

#### Examples

- Remote access

Address assignment is made possible by a special entry in the IP routing table. 255.255.255.255 is specified as the network mask as the IP address to be assigned to the remote site in the 'Router-name' field. In this case, the router name is the name, with which the remote site must identify itself to the LANCOM.

In addition to the IP address, the addresses of the DNS and NBNS servers (Domain Name Server and NetBIOS Name Server) including the backup server from the entries in the TCP/IP module are transmitted to the remote station during this configuration.

So that everything functions properly, the remote site must also be adjusted in such a way that it can obtain the IP address and the name server from the LANCOM. This can be accomplished with Windows dial-up networking through the settings in the 'TCP settings' under 'IP address' and 'DNS configuration'. This is where the options 'IP address assigned by server' and 'Specify name server addresses' are activated.

- Internet access

If Internet access for a local network is realized via the LANCOM, the assignment of IP addresses can occur in a reverse manner. Configurations are possible in which the LANCOM does not have a valid IP address in the Internet and is assigned one by the Internet provider for the duration of the connection. In addition to the IP address, the LANCOM also receives information via the DNS server of the provider during the PPP negotiation.

In the local network, the LANCOM is only known by its internal valid intranet address. All workstations in the local network can then access the same Internet account and also reach e.g. the DNS server.

Windows users are able to view the assigned addresses via LANmonitor. In addition to the name of the remote station, the current IP address as well as the addresses of DNS and NBNS servers can be found there. Options such as channel bundling or the duration of the connection are also displayed.

### 7.10.4 Settings in the PPP list

In the PPP list, you are able to specify your own definition of PPP negotiation for every remote site contacting your network.

The authentication of point-to-point connections in the WAN commonly relies on one of the protocols PAP, CHAP, MSCHAP or MSCHAPv2. The protocols here have a "hierarchy" amongst themselves, i. e. MSCHAPv2 is a "higher-level" protocol than MSCHAP, CHAP and PAP (higher protocols provide higher security). Many dial-in routers at Internet providers allow up-front authentication using a higher-level protocol such as CHAP, but only support the use of PAP further down the line. If the setting for the protocol for authentication is fixed in the LANCOM, the connection may fail because no common authentication protocol can be negotiated.

**!** In principle authentication can be repeated while the connection is being negotiated. Another protocol can be selected if, for example, it can only be recognized from the username at the earliest. However, this repeat negotiation is not supported in all scenarios. In particular when dialing in over UMTS, the LANCOM must explicitly refuse the provider's request for CHAP to be able to provide PAP user data for requests to be forwarded by the provider.

A flexible setting for the authentication protocols in the LANCOM ensures that the PPP connection is established as required. In addition, one or more protocols can be defined that are accepted for authentication of remote sites in the LANCOM (inbound connections) and on login of the LANCOM into other remote sites (outbound connections).

- When establishing inbound connections, the LANCOM requires the lowest of the permitted protocols, but where possible it also permits the remote site to use one of the higher-level protocols (enabled in the LANCOM).
- When establishing outbound connections, the LANCOM offers all enabled protocols, but only permits a selection from precisely these protocols. It is not possible to negotiate one of the disabled, possibly higher-level, protocols.

The PPP authentication protocols are set in the PPP list.

LANconfig: Communication / Protocols / PPP list

WEBconfig: Setup / WAN / PPP

### 7.10.5 The meaning of the DEFAULT remote site

During PPP negotiations, a remote site dialing-in to the LANCOM logs on with its name. The LANCOM can use the name to retrieve the permitted values for authentication from the PPP table. At the start of the negotiation, the remote site occasionally cannot be identified by call number (ISDN dial-in), IP address (PPTP dial-in) or MAC address (PPPoE dial-in). It is thus not possible to determine the permitted protocols in this first step. In these cases, authentication is performed first with those protocols enabled for the remote site with name DEFAULT. If the remote site is authenticated successfully with these settings, the protocols permitted for the remote site can also be determined.

If authentication uses a protocol entered under DEFAULT, but which is not permitted for the remote site, then authentication is repeated with the permitted protocols.

### 7.10.6 RADIUS authentication of PPP connections

PPP connections can also be authenticated by an external RADIUS server. However, these external RADIUS servers do not necessarily support all available protocols. For this reason, the permitted protocols can also be selected in the configuration of the RADIUS authentication. LCP negotiation is restarted with the permitted protocols if the RADIUS server does not support the negotiated protocol.

#### WAN RADIUS table

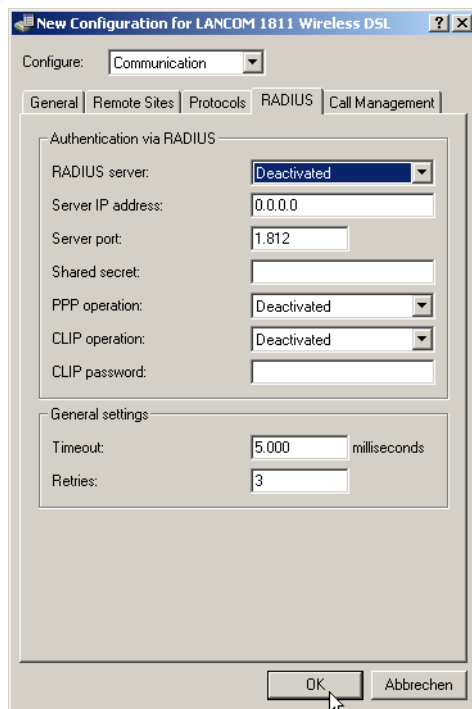

LANconfig: Communication / RADIUS

WEBconfig: Setup / WAN / RADIUS

## 7.11 DSL dial-in over PPTP

Some DSL providers enable dial-in over PPTP (**P**oint-to-**P**oint **T**unneling **P**rotocol) instead of PPPoE. PPTP is an extension of PPP, partly developed by Microsoft.

With PPTP it is possible to build up a "tunnel" over IP nets to a remote station. A tunnel is a logical shielded connection, that protects the transferred data from unauthorized access. For this purpose the encoding algorithm RC4 is used.

### 7.11.1 Configuration of PPTP

As soon as the internet access over PPTP is selected the LANCOM enquires all needed PPTP parameters with the Internet Access Wizard. Additionally to the entries for PPPoE access the IP address of the gateway must be specified. A PPTP gateway is often a DSL modem. Detailed information is available from your DSL provider.

The configuration can be changed in the PPTP list:

LANconfig: communication / protocols / PPTP list

WEBconfig: LCOS menu tree / Setup / WAN / PPTP list

The PPTP configuration consists of three parameters:

- 'Remote site'—the entry from the DSL-Broadband-Peers list.
- 'IP address'—IP address of the PPTP gateway, often the address of the DSL modem.
- 'Port'—IP port the PPTP protocol runs on. For conformity with the protocol standard enter the port '1.723'.

## 7.11.2 Addition(s) to LCOS 7.80

### 32 additional gateways for PPTP connections

#### Introduction

Up to 32 additional gateways can be configured to assure the availability of any PPTP remote station. Consequently, each PPTP remote station can use a total of up to 33 gateways.

#### Configuration

The additional PPTP gateways are defined in a separate list.

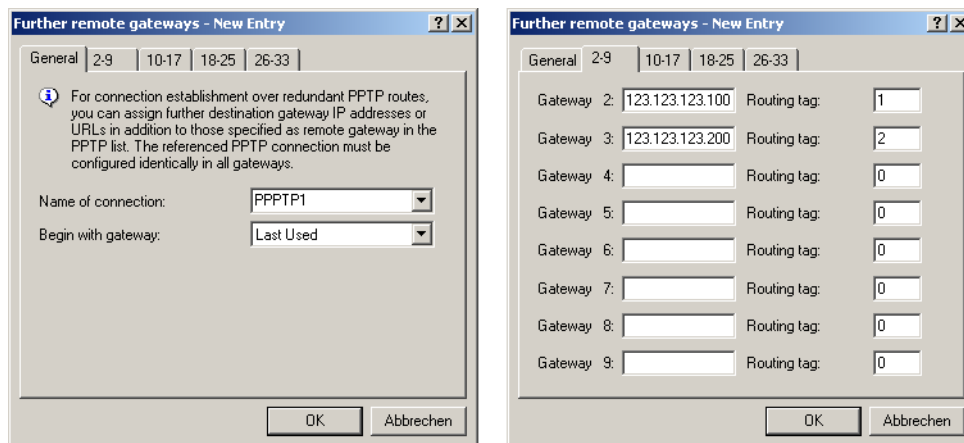

LANconfig: Communication / Protocols / Further remote gateways

WEBconfig: LCOS menu tree / Setup / WAN E Additional PPTP gateways

- Name of connection

Here you select the PPTP remote site that this entry applies to.

Possible values:

- Select from the list of defined PPTP remote stations.

Default:

- Empty.

- Begin with

Here you select the order in which the entries are to be tried.

Possible values:

- Last used: Selects the entry for the connection which was successfully used most recently.
- First: Selects the first of the configured remote sites.



- Random: Selects one of the configured remote sites at random. This setting provides an effective measure for load balancing between the gateways at the headquarters.

Default:

- Last used

- Gateway 2 to 33

Enter the IP addresses of the additional gateways to be used for this PPTP remote station.

Possible values:

- IP address or 63 alphanumeric characters.

Default:

- Empty.

- Routing tag

Enter the routing tag for setting the route to the relevant remote gateway.

Possible values:

- Maximum 5 characters.

Default:

- 0.



If you do not specify a routing tag here (i.e. routing tag is 0), then the routing tag configured for this remote station in the PPTP connection list will be taken for the associated gateway.

## 7.12 Extended connection for flat rates—Keep-alive

The term flat rate is used to refer to all-inclusive connection rates that are not billed according to connection times, but instead as a flat fee for fixed periods. With flat rates, there is no longer any reason to disconnect. On the contrary: New e-mails should be reported directly to the PC, the home workplace is to be continuously connected to the company network and users want to be able to reach friends and colleagues via Internet messenger services (ICQ etc.) without interruption. This means it is desirable to continuously maintain connections.

With the LANCOM the Keep-alive function ensures that connections are always established when the remote station has disconnected them.

### 7.12.1 Configuration of Keep-alive function

The keep alive procedure is configured in the peer list.

If the holding time is set to 0 seconds, a connection is not actively disconnected by the LANCOM. The automatic disconnection of connections over which no data has been transmitted for a longer time is deactivated with a holding time of 0 seconds then. However, connections interrupted by the remote site are not automatically re-established with this setting.

With a holding time of 9,999 seconds the connection is always re-established after any disconnection. Additionally, the connection is re-established after a reboot of the device ('auto reconnect').

## 7.13 Callback functions

LANCOM models with ISDN interface support the automatic callback function.

In addition to callback via the D channel, the CBCP (Callback Control Protocol) specified by Microsoft and callback via PPP as per RFC 1570 (PPP LCP extensions) are also offered. There is also the option of a particularly fast callback using a process developed by LANCOM. PCs with Windows operating system can be called back only via the CBCP.

### 7.13.1 Callback for Microsoft CBCP

With Microsoft CBCP, the callback number can be determined in various ways.

- The party called does not call back.
- The party called allows the caller to specify the callback number itself.
- The party called knows the callback numbers and **only** calls these back.

Via CBCP, it is possible to establish connection to the LANCOM from a PC with Windows operating system and also to be called back by this PC. Three possible settings are selected in the remote sites list via the callback entry as well as the calling number entry.

The screenshot shows a dialog box titled "Remote sites (ISDN/serial) - New Entry". It contains the following fields and options:

- Name: MAIN
- Phonenumber: 123456
- Short hold time: 20 seconds
- Short hold time (bundle): 20 seconds
- Layer name: PPPHDL (dropdown menu)
- Automatic callback:
  - No callback
  - Call back the remote site
  - Call back the remote site (fast procedure)
  - Call back the remote site after name verification
  - Wait for callback from remote site

Buttons for "OK" and "Cancel" are located on the right side of the dialog.

#### No callback

For this setting, the callback entry must be set to 'off' when configuring via WEBconfig or in the console.

#### Callback number specified by caller

For this setting the callback entry must be set to 'Call back the remote site after name verification' (or must have the value 'Name' in WEBconfig or in the console). In the peer list **no** telephone number may be specified.

After the Authentication an input window appears on the caller's screen in Windows that requests the ISDN telephone number of the PC.

#### The calling number is determined in the LANCOM

For this setting the callback entry must be set to 'Call back the remote site after name verification' (or must be set to the value 'Name' in WEBconfig or in the console). In the peer list **one** telephone number must be specified.

Some Windows versions (especially Windows 98) prompt the user to confirm the callback to the telephone number stored in the LANCOM ('Administrator Specified') with an input window. Other Windows versions only inform the user that the PC is waiting for the callback from the LANCOM.

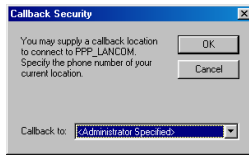

The callback to a Windows workstation occurs approx. 15 seconds after the first connection has been dropped. This time setting cannot be decreased since it is a Windows default setting.

### 7.13.2 Fast callback

This fast process is ideal if two LANCOM are to communicate with one another via callback.

- The caller who may wish to be called back can activate the function 'Wait for callback from remote site' in the peer list (or 'Looser' when configuring via WEBconfig, terminal program or Telnet).
- The callback party selects 'Call back the remote site (fast procedure)' in the peer list and enters the calling number ('fast' when configuring via WEBconfig, terminal program or Telnet).



For fast callback using the LANCOM Systems method, the number list for answering calls must be kept up to date at both ends.

### 7.13.3 Callback with RFC 1570 (PPP LCP extensions)

The callback as per 1570 is the standard method for calling back routers of other manufacturers. This protocol extension describes five possibilities for requesting a callback. All versions are recognized by LANCOM. All versions will be processed in the same way, however:

The LANCOM drops the connection after authenticating the remote station and then calls back the station a few seconds later.

#### Configuration

For callback as per PPP you select the option 'Call back the remote site' in LANconfig or 'Auto' with configuration via WEBconfig, terminal program or Telnet.



For callback as per PPP the number list for answering calls in the LANCOM must be up to date.

### 7.13.4 Overview of configuration of callback function

The following options are available in the peer list under WEBconfig and terminal program/telnet for the callback function:

With this entry ...	... you set up the callback in this manner:
'Off'	No callback occurs.
'Auto' (not for Windows operating systems, see below)	The remote station will be called back if so specified in the peer list. At first, the call is denied and as soon as the channel is clear again, it is called back (duration is approx. 8 seconds). If the remote station is not found in the numerical list, it is first accepted as the DEFAULT remote station, and the callback is negotiated during the protocol negotiation. A charge of one unit is incurred for this.
'Name'	Before a callback occurs, a protocol negotiation is always carried out even when the remote station was found in the numerical list (e.g. for computers with Windows having direct dialing on the device). Here only minor charges result.

With this entry ...	... you set up the callback in this manner:
'fast'	When the remote station is found in the numerical list, a quick callback is carried out, i.e., the LANCOM sends a special signal to the remote station and calls back immediately when the channel is clear again. After approx. 2 seconds, the connection is established. If the remote station does not take back the call immediately after the signal, then after two seconds the situation reverts back to normal callback procedures (duration is once again approx. 8 seconds). This process is only available for DSS1 connections.
'Looser'	Use the 'Looser' option when a callback is expected from the remote station. This setting carries out two functions simultaneously. On the one hand, it ensures that a custom connection setup is taken back when there is an incoming call from the called remote station, and on the other hand, the function is activated with this setting to be able to react to the rapid callback procedure. In other words, in order to be able to use rapid callback, the caller must be in the 'Looser' mode while the party being called must discontinue callback with 'LANCOM'.

 The setting 'Name' offers the greatest security when an entry is made into the number list as well as the PPP list. The setting 'LANCOM' offers the fastest callback method between two LANCOM Systems routers.

 With Windows remote stations, the 'Name' setting **must** be selected.

## 7.14 ISDN Channel bundling with MLPPP

When establishing an ISDN connection to a remote station with PPP capability, you can transmit data more quickly. Data can be compressed and/or several B channels can be used for data transmission (channel bundling).

Connecting with cable bundling is distinguished from "normal" connections in that not only one, but rather several B channels are used parallel for data transmission.

MLPPP (**M**ultilink **PPP**) is used for channel bundling. This procedure is of course only available when PPP is used as the B-channel protocol. MLPPP is used e.g. for Internet access via Internet provider, which also operate remote stations with MLPPP capability from your direct dialing nodes.

 Bundling over MLPPPoE can also be arranged for DSL channels.

### 7.14.1 Two methods of channel bundling

- Static channel bundling

If a connection is established with static channel bundling, the LANCOM tries to establish the second B channel immediately after setting up the first B channel. If this does not work because, for example, this channel is already taken by another device or a different connection within the LANCOM, the connection attempt is automatically and regularly repeated until the second channel is available for it.

- Dynamic channel bundling

In the case of a connection with dynamic channel bundling, the LANCOM first only establishes one B channel and begins transmitting data. If, during this connection, it determines that the throughput rate lies above a certain threshold value, it tries to add the second channel.

If the second channel is established and the data throughput rate drops below the threshold value, the LANCOM waits for the set B2 timeout period and then automatically closes the channel again. In this way, the per minute charges are fully utilized so long as rate information is communicated during the connection. Therefore, the LANCOM only uses the second B channel if and as long as it really needs it.

## 7.14.2 Here's how to configure your system to combine channels

The configuration of channel bundling for a connection is made up of three settings.

1. Select a communication layer for the remote station from the layer list that has bundling activated in the Layer-2 options. Select from the following Layer-2 options:
  - **compr.** according to the LZS data compression procedure (Stac) reduces the amount of data if the data hasn't already been compressed. This procedure is also supported by routers of other manufacturers and by ISDN adapters under Windows operating systems.
  - **bundle** uses two B channels per connection.
  - **bnd+compr** uses both (compression and channel bundling) and provides the maximum possible data transmission performance.
2. Now create a new entry in the peer list. When doing so, watch the holding times for the connection. Please observe the following rules:
  - Depending on the type of application, the B1 hold time should be increased to such a level so that the connection is not dropped prematurely because of packets not being transmitted for a short time. Experience has shown that values between 60 and 180 seconds are a good basis which can be adapted as required during operation.
  - The B2 holding time determines whether static or dynamic channel bundling will be used (see above). A B2 holding time of '0' or '9999' ensures that the bundling will be static; values in between permit dynamic channel bundling. The B2 holding time defines how long the data throughput may lie below the threshold for dynamic channel bundling without the second B channel automatically being disconnected.
3. Use the entry for the Y connection in the Router interface list to determine what should happen if a second connection to a different remote station is requested during an existing connection using channel bundling.

WEBconfig: LCOS menu tree / Setup / WAN / Router-interface-list

1. Y connection **On**: The router interrupts the bundled connection to establish a connection to the other remote station. When the second channel is free again, the originally bundled connection automatically takes the channel back (always in the case of static bundling, only as required when using dynamic bundling).
  - Y connection **Off**: The router maintains the existing bundled connection; the establishment of the new connection must wait.

---

 Please note that if channel bundling is used, the cost of two connections is charged. Here no additional connections via the LANCAPI are possible! So you should only use channel bundling if the double transmission capacity can really be used in full.

## 7.15 Operating a modem over the serial interface

---

 This section refers only to devices with a serial configuration interface.

### 7.15.1 Introduction

Internationally, analog telephone connections are just as common in the business world as the predominant ISDN connections in Germany. The operation of international networks thus places particular demands on remote maintenance options and for high-availability of the gateways and thus requires different interfaces than the ISDN common in Germany. Apart from conventional analog telephone lines, mobile telephone networks such as GSM or GPRS may, in certain cases, represent the only way of providing remote maintenance without broadband or other cabled access.

In response to these requirements, most LANCOM models with a serial interface can be extended with an additional WAN interface with the use of analog modems, GSM or GPRS. The following functions are available with a suitable modem in combination with the LANCOM Modem Adapter Kit:

- Internet access via modem with all of the router functions such as firewall, automatic connection establishment and termination, etc.
- Remote maintenance (e.g. dial-in to international sites)
- Backup connection (e.g. high-availability through GSM/GPRS modem connection)

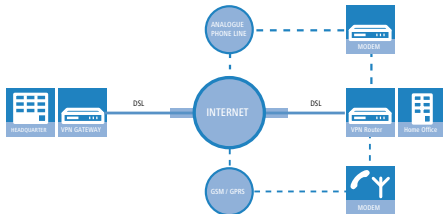

### 7.15.2 System requirements

The following are required to set up a backup connection over the serial interface:

- LANCOM with serial configuration interface and support for LANCOM modem adapter kit. For devices with serial configuration interface please refer to the table to see, whether your model supports the modem operation at serial interface.
- LANconfig or alternatively a web browser or Telnet
- Serial configuration cable (supplied with the device)
- Analog modem, Hayes compatible, with access to a suitable analog telephone connection (D-sub9 or D-sub25 connector)
- LANCOM modem adapter kit to connect the modem over the serial configuration cable

### 7.15.3 Installation

The installation simply involves the connection of the modem with the LANCOM Modem Adapter Kit with the serial configuration interface of the LANCOM.

**!** Please do not use any other adapters than the original LANCOM Modem Adapter Kit! The contact assignment of the LANCOM Modem Adapter Kit differs from other commercial adapters like "null modem cables" or the like. The use of uncompliant accessories will cause serious damage on the LANCOM and/or the modem. For further details please refer to the .

### 7.15.4 Set the serial interface to modem operation

The operation of the serial interface requires the operating mode and bitrate to be set.

- Operating mode [default: outband]
  - Outband: In this mode, the serial interface is only used for configuration with a terminal program.
  - Modem: In the 'Modem' setting, the device attempts to find a modem connected to the serial interface. If this is successful then the modem can be used as an additional WAN interface. If a computer running a terminal program is detected, then the device automatically switches the interface into outband mode.
  - Interlink: Direct connection between two LANCOM devices
- Bitrate [default: 115,200 bps.]

Set the maximum bitrate supported by your modem. The serial interfaces of LANCOM devices support data rates of 19,200 bps, 38,400 bps, 57,600 bps up to a maximum of 115,200 bps.

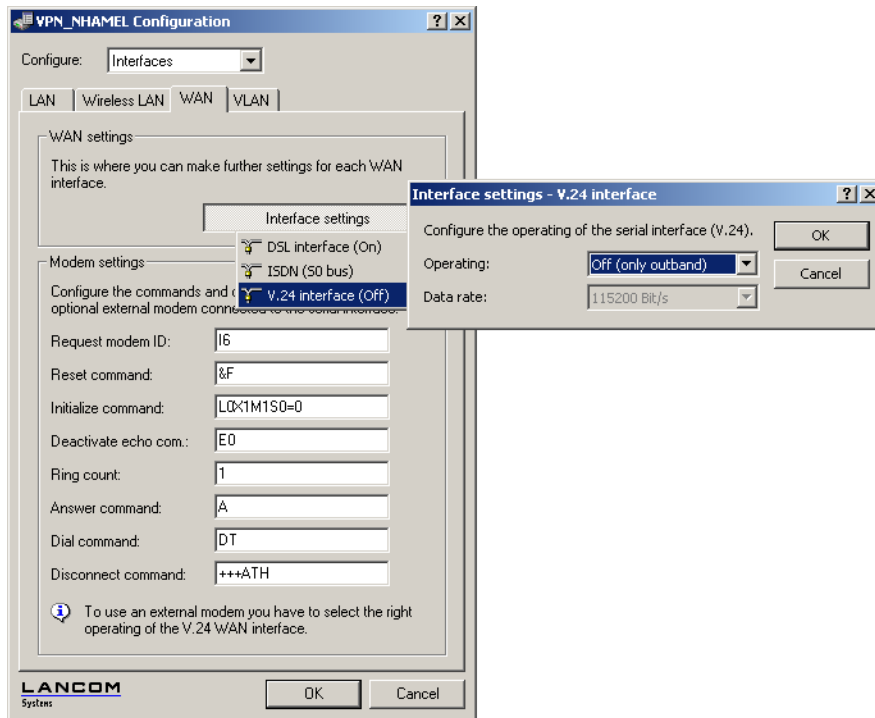

LANconfig: Interfaces / WAN / V.24-Interface

WEBconfig: LCOS menu tree / Setup / Interfaces / V.24-Interface

**!** As long as the LANCOM is set to modem mode, a terminal program operating over the serial interface will display the AT commands that the LANCOM device transmits while attempting to identify a connected modem. In the terminal program, press the return key repeatedly until the modem identification is interrupted and start the configuration session.

### 7.15.5 Configuration of modem parameters

The operation of a modem at the serial interface requires the following settings:

- Request modem ID [Default: AT I 6]
- Reset command [default: AT&F]
- Initialize command [default: AT L0 M1 X1 S0 =0]
  - L0: Loudspeaker quiet
  - M1: Loudspeaker on while connecting
  - X1: Operation at an extension
  - S0=0: Disable auto answering
- Deactivate modem echo [default: ATE0]
- AT polling cycle time [Default: 1 in seconds]
- AT polling count [Default: 5]
- Ring count [Default: 1]
- Initialize answer command
- Answer command [Default: ATA]
- Initialize dial command
- Dial command [default: ATDT]

- Escape sequence to terminate data phase resp. to return to command phase [Default: +++]
- Hold time after escape sequence [Default: 1 000 in milliseconds]
- Disconnect: command to hang up during data phase [Default: ATH]

 The modem parameters are set with values that should suit most modems. Thus changes are generally not necessary. Refer to the documentation for your modem for settings that vary from these.

## Setting up a GPRS backup connection

If the connection is to use a GPRS-capable modem at the serial interface, you will need the APN name and the dial-up telephone number. The following init-strings for the configuration apply to T-Mobile and Vodafone:

- T-Mobile
  - Init-string: L0X1M1S0=0+CGDCONT=1, "IP", "internet.t-dl.de"
  - Dial-up number: \*99#
- Vodafone
  - Init-string: L0X1M1S0=0+CGDCONT=1, "IP", "web.vodafone.de"
  - Dial-up number: \*99# or \*99\*\*\*1#

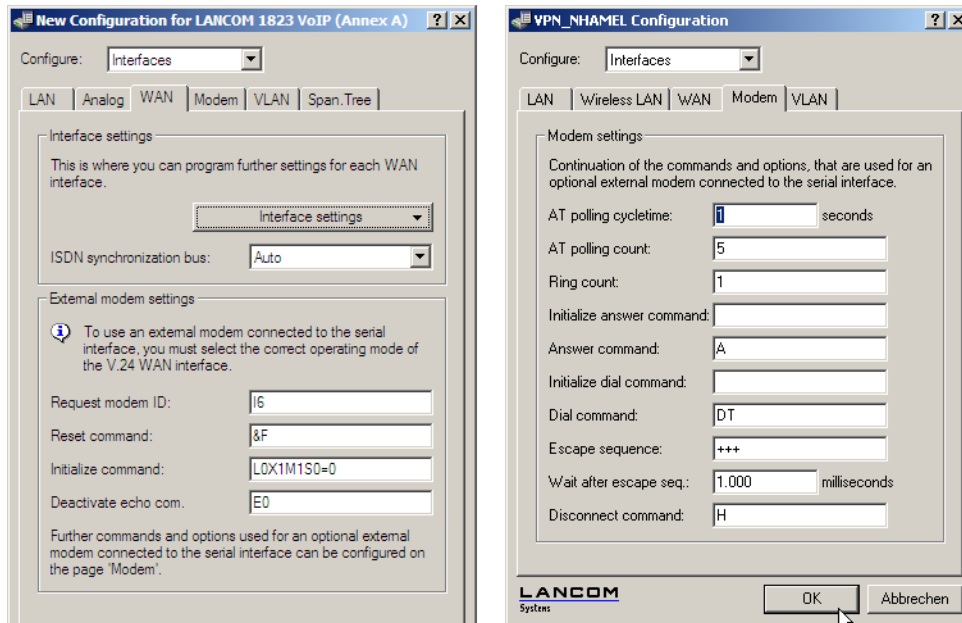

## Setting up a GPRS backup connection

If the connection is to use a GPRS-capable modem at the serial interface, you will need the APN name and the dial-up telephone number. The following init-strings for the configuration apply to T-Mobile and Vodafone:

- T-Mobile
  - Init-string: L0X1M1S0=0+CGDCONT=1, "IP", "internet.t-dl.de"
  - Dial-up number: \*99#
- Vodafone
  - Init-string: L0X1M1S0=0+CGDCONT=1, "IP", "web.vodafone.de"
  - Dial-up number: \*99# or \*99\*\*\*1#

LANconfig: Interfaces / WAN or / Modem



WEBconfig: LCOS menu tree / Setup / Interfaces / Modem-Parameters

### Entering special characters in the console

For a GPRS dial-up, the initialisation strings require the entry of inverted commas and equal signs. Certain special characters can be correspondingly marked with a leading backslash:

- \*
- "
- =
- space
- **Example:** `+cgdcont\<=1,\"IP\", \"internet.t-d1.de\"`

As an alternative, the entire command sequence can be enclosed within inverted commas. In this case, those inverted commas which are inside the surrounding inverted commas must be preceded by a backslash.

- **Example:** `\"+cgdcont=1,\"IP\", \"internet.t-d1.de\"`

## 7.15.6 Direct entry of AT commands

The command

- `sendserial "AT..."`

allows you to use Telnet to send a character string directly to a modem that is connected to the LANCOM. This function allows you to send any AT commands to the modem.

 Sending AT commands is possible in the internal modem state 'idle' or 'Modem ready' only. The responses can be found in the serial trace.

## 7.15.7 Statistics

Statistics about activities of the serial interface can be accessed with a terminal program or Telnet under:

`Status/Modem-Status`

The statistics show the following states:

- the type of modem identified
- the status of its last connection, e.g. the transfer rate, the transfer protocol used or the error-detection method used
- internal state of modem management, e.g.
  - device detection
  - interface deactivated
  - modem initialization
  - modem ready
  - connection establishment
  - modem in data mode

These messages may be very helpful for debugging purposes.

## 7.15.8 Trace output

The command

- `trace + serial`

allows you to start the trace output for the serial interface in a Telnet session when a LANCOM has a modem connected. The output shows all messages exchanged up until the establishment of data transfer between the modem and the LANCOM.

### 7.15.9 Configuration of remote sites for V.24 WAN interfaces

To establish a connection to a remote station via the modem connected to the serial interface, a corresponding entry in the remote site list (ISDN/serial) must be generated. The remote sites list (ISDN/serial) contains the following information:

- Name: Name of the remote site
- Telephone number: Telephone number that reaches the remote site. The field can be left empty if calls are to be received only.
- Hold time: This time defines how long a connection is kept active even if no more data is being transferred. If a zero is entered, the connection will not be interrupted automatically. A hold time of "9999" means that the connection is permanently held open. If it is interrupted, then the connection will be actively opened up again. This behavior is known as **keep alive**.
- 2. Hold time: Is ignored.
- Layer name: The layer 'V.24\_DEF' is selected for the connection over the serial WAN interface. The layer is preset and does not need further configuration. The layer 'V.24\_DEF' uses the following settings:
  - Encapsulation: Transparent
  - Layer 3: APPP (asynchronous PPP)
  - Layer 2: Transparent
  - Options: none
  - Layer 1: SERIAL (shows that the serial interface is being used for connections via the layer 'V.24\_DEF')

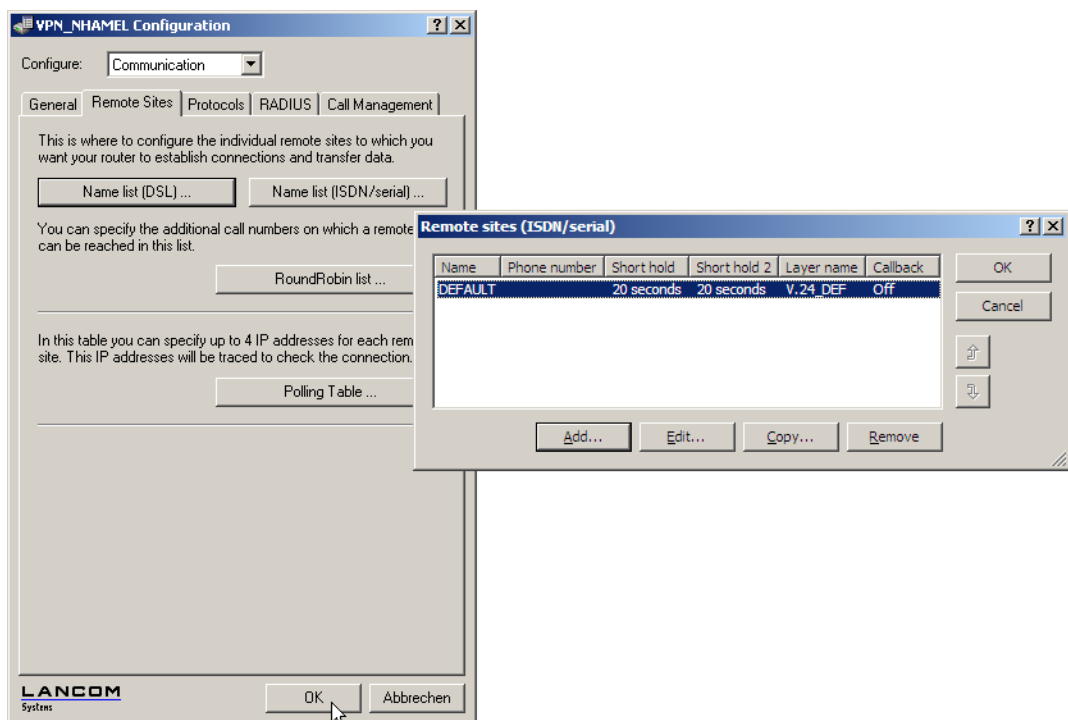

The remote site list with the remote sites for the modem at the serial interface can be found under the following paths:

LANconfig: Communication / Remote sites / Remote sites (ISDN/serial)

WEBconfig: LCOS menu tree / Setup / WAN E Dialup-Peers

Once an entry in the remote site list has been generated for the WAN interface, this remote station can be used just like any other for routing and WAN connections.

### 7.15.10 Configuration of a backup connection on the serial interface

The configuration of a backup connection via a modem at the serial interface requires first of all an entry in the Dialup-Peers list so that the required remote site can be reached. The following entries will also be required for the configuration of the LANCOM:

- Entry in the backup table

In the backup table, generate an entry for the remote site that is to be used for the backup connection. This remote site is to be allocated to the remote site that is to be called by the modem at the serial interface.

The backup table is to be found under the following paths:

LANconfig: Communication / Call Management / Backup Table

WEBconfig: LCOS menu tree / Setup / WAN E Backup table

- Entry in the polling table

If the link to the remote station that is to be backed up cannot be checked by LCP polling (with PPP only) then an additional entry in the polling table is required. This involves assigning the remote site with an IP address that can be regularly tested with a ping command. The IP address should typically be a computer directly at the opposite end of the connection being tested, e.g. a DNS server in your provider's network.

The polling table is to be found under the following paths:

LANconfig: Communication / Remote Sites / Polling Table

WEBconfig: LCOS menu tree / Setup / WAN E Polling table

### 7.15.11 Contact assignment of modem adapter kit

Device signal	D-Sub9 plug	Device or modem signal	D-Sub9 plug
TxD	3	RxD	2
RxD	2	TxD	3
RTS	7	CTS	8
CTS	8	RTS	7
DTR	4	DCD	1
DCD	1	DTR	4
GND	5	GND	5

## 7.16 Manual definition of the MTU

Many Internet providers operate their own backbone; however, their customers dial in to the network over the access nodes provided by third-party telecommunications providers. The two-stage dial-in procedure can lead to problems with the realized data rate:

- When dialing into the nodes of Deutsche Telekom, for example, a LANCOM negotiates a permissible maximum transmission unit (MTU), which defines the greatest possible size of unfragmented data packet. This MTU is then used by the LANCOM.
- When the data packets are forwarded to the actual provider, an additional header is added which increases the size of the data packets again. For the data packets to meet with the permitted size, they must now be fragmented into smaller units. This additional fragmentation can cause losses in the data-transfer speeds.

This problem can be avoided by entering a fixed MTU for each remote site.

## 7.16.1 Configuration

WEBconfig: LCOS-menu tree / Setup / WAN / MTU list

The table contains the following entries:

- **Device name:** Name of the remote device. It can be a physical or a virtual (PPTP/VPN) remote site
- **MTU:** MTU to be used for the connection

## 7.16.2 Statistics

Under **Status / WAN-statistics** you will find the MTU statistics recorded for all current connections. The table is partially dynamic and begins with 16 entries. Like the MTU-list under **Setup / WAN** it includes two columns in which the device name and the MTU are stored.

Remote site	MTU	Remark
INET	1200	The INET remote site is the Internet connection and a forced MTU of 1200 bytes.
MULTI	1492	MULTI is a PPPoE connection, for which the MTU was negotiated (and is consequently 1492 bytes).
TESTVPN	1100	TESTVPN is a VPN connection established via the Internet. An assumed overhead of 100 bytes is taken for VPN connections, and consequently the MTU here is 1100 bytes.
TESTVPN-PPTP	1060	TESTVPN-PPTP is a PPTP connection established over the VPN connection TESTVPN. The overhead for PPTP connections is 40 bytes, and consequently the MTU here is 1060 bytes.

 MTU lists and MTU statistics are only available for devices with a DSL or ADSL interface.

## 7.17 WAN RIP

In order for routes learned from RIP to be broadcast across the WAN, the respective remote sites can be entered into the WAN RIP table. The WAN RIP table contains the following values:

- **Remote site:** The name of the remote site is listed in the 'Remote site' column
- **RIP type:** The column RIP type details the RIP version with which the local routes are propagated
- **RIP accept:** The column RIP accept lists whether RIP from the WAN is to be accepted. The RIP type must be set for this.
- **Masquerade:** The column Masquerade lists whether or not masquerading is performed on the connection and how it is carried out. This entry makes it possible to start WAN RIP even with an empty routing table. The following values are possible:
  - **Auto:** The masquerade type is taken from the routing table (value: 0). If there is no routing entry for the remote site, then masquerading is not performed.
  - **On:** All connections are masqueraded (value: 1).
  - **Intranet:** IP masquerading is used for connections from the intranet, connections from the DMZ pass through transparently (value: 2).
- **Default tag:** The column Default tag lists the valid "Default routing tag" for the WAN connection. All untagged routes are tagged with this tag when sent on the WAN.
- **Routing tags list:** The column Routing tags list details a comma-separated list of the tags that are accepted on the interface. If this list is empty, then all tags are accepted. If at least one tag is in the list, then only the tags in this list are accepted. When sending tagged routes on the WAN, only routes with valid tags are propagated.

All learned routes from the WAN are treated internally as untagged routes and propagated on the LAN with the default tag (0). In the WAN, they are propagated with the tag with which they were learned.

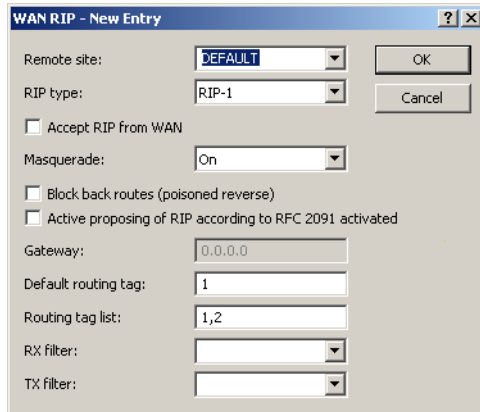

LANconfig: IP-Router / General

WEBconfig: LCOS-menu tree / Setup / IP-Router / RIP / WAN-Sites

## 7.18 The rapid spanning tree protocol

In networks with many switches and bridges, many physical connections can exist between two stations that are connected to the network. These redundant data paths are desirable because they can offer alternative paths to the desired destination in case individual network paths fail. On the other hand, these multiple connections can also lead to loops or cause network stations to receive multiple frames. Both occurrences negatively impact free data traffic performance in the network.

The Spanning Tree Protocol (STP) enables an analysis of the network at the layer 2 level and, as such, offers solutions for intelligent path selection between two network stations below the routing layer. By discovering redundant paths between network stations, STP builds a unique structure in which loops and double packets can be avoided. To this end, so-called Bridge Protocol Data Units (BPDUs) are sent as a multicast to a specific MAC address. The BPDUs allow redundant paths to be discovered as well as the distance and the data rate available on this connection. Using these values, the Spanning Tree Protocol calculates a priority (also called route or path costs) with which the various connections are to be treated. The low-priority connections are disabled and are therefore no longer available for clients. Through the reduction of non-redundant connections between the clients, the protocol builds a tree which unambiguously defines all of the connections that arise from a central switch (root bridge).

The BPDUs are sent regularly in the network in order to check the availability of the connections. If a connection fails, then the network analysis is triggered again; the possible paths and the corresponding priorities are redefined.

After initialisation all ports will initially be in the "blocking" state, in which only BPDUs are transmitted. The ports subsequently switch to the states of "listening" and then "learning" before reaching "forwarding" which allows payload data to be exchanged via the ports.

### 7.18.1 Classic and rapid spanning tree

The early version of the spanning-tree protocol compliant with IEEE 802.1D, here referred to as classic spanning tree, had the problem that changes to topology after a connection failure were implemented very slowly: Depending on the complexity of the network, the classic spanning tree takes between 20 seconds and a minute to establish new routes. For many network services a failure of this length of time is unacceptable.

The spanning tree protocol was improved and published as the "Rapid Spanning Tree Protocol" (RSTP), initially as the IEE 802.1t/w standard and later as a part of the newly published IEEE 802.1D. Even though the classic spanning tree protocol was thus withdrawn, it continues to be supported by LCOS.

## 7.18.2 Improvements from rapid spanning tree

As mentioned above, the primary aim of RSTP is to accelerate the activation of network paths once an active connection has failed. RSTP achieves this by dispensing with the states "blocking" and "listening" to reduce the time required to update the network paths to just a few seconds. In case of a network path failure, not all of the links are blocked until the new topology has been calculated; instead, only the failed connections are unavailable for use.

RSTP also enables the administrator to configure information on network topology.

- A bridge port can be defined as an edge port. An edge port is the only bridge port leading to the connected LAN segment, i.e. no other bridges are connected to the LAN segment, but workstations or servers only, for example. As these ports cannot lead to loops, they change immediately into the forwarding state without waiting for the network topology to be determined. However, RSTP continues to monitor these ports. Should BPDUs be unexpectedly received at an edge port due to another bridge being connected to the LAN, the ports automatically return to their normal state.
- A bridge port can also operate as a point-to-point link. In this case the port is directly connected with an additional bridge. Since no additional stations can occur between the two bridges, the switch into the forwarding state can take place faster.

In the ideal case, RSTP immediately resorts to familiar alternative network paths in case of connection failure.

## 7.18.3 Configuring the Spanning Tree Protocol

The following parameters are available for configuring RSTP or STP functionality in LANCOM:

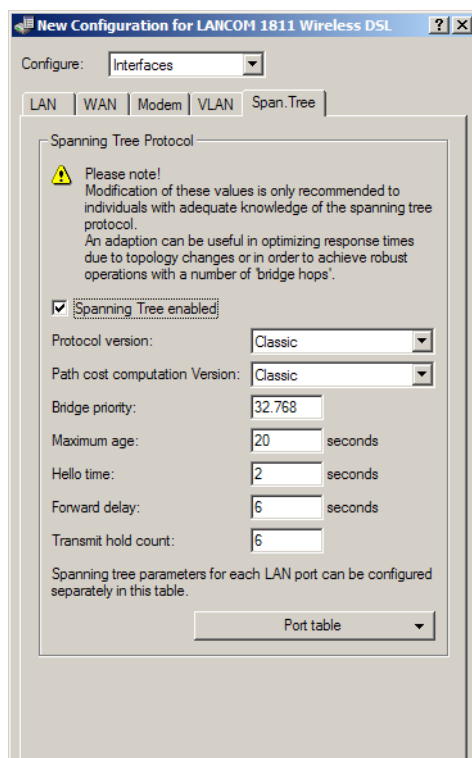

LANconfig: Interfaces / Span. Tree

WEBconfig: LCOS-menu tree / Setup / LAN-Bridge / Spanning-Tree

### General parameters

- Spanning tree operating

When Spanning Tree is turned off, a LANCOM does not send any Spanning Tree packets and passes received packets along instead of processing them itself.

- Protocol version

- Classic: Uses the classical STP to determine network topology.
- Rapid: Uses the RSTP method to determine network topology.

---

ⓘ RSTP is compatible with STP. Network components which only support classical STP continue to be supported where RSTP is operational.

- Path Cost Computation

- Classic: Uses the classical STP method to compute path costs.
- Rapid: Uses the RSTP method to compute path costs.

- Bridge priority

Defines the priority of the bridge in the LAN. This can influence which bridge should preferably be made root bridge by the Spanning Tree Protocol.

---

ⓘ So as to maintain compatibility with RSTP, this value should only be adjusted in steps of 4096 owing to the fact that RSTP uses the lower 12-bits of this 16-bit value for other purposes.

- Maximum Age

This value defines the time (in seconds) after which a bridge drops messages received through Spanning Tree as 'outdated'. This parameter defines how quickly the Spanning Tree algorithm reacts to changes, for example due to failed bridges.

- Hello Time

This parameter defines (in seconds) in which intervals a device selected to be the root bridge sends Spanning Tree information into the LAN.

- Forward-Delay

This time (in seconds) determines how much time must pass at a minimum before a Spanning Tree port can change the status (listening, learning, forwarding).

---

ⓘ When using RSTP the forwarding delay often has no effect because RSTP has suitable mechanisms of its own to prompt a rapid switching into the forwarding state.

---

ⓘ Modifying any of these three time values is only recommended for those with exact knowledge of the Spanning Tree protocol.

- Transmit-Hold-Count

Number of BPDUs which can be transmitted by RSTP before a one second pause commences.

---

ⓘ When using classical STP the transmit-hold count has no effect.

## Port table

The port table can be used to set the following values separately for all available ports (LAN, wireless LAN, point-to-point connections).

- Mark as edge port

Marks the port as an edge port which is not connected to any further bridges but to workstations or servers only. Edge ports switch immediately into the forwarding state.

---

ⓘ Edge ports continue to be monitored by RSTP. If a port of this type receives BPDUs, then its status as an edge port is removed.

- Priority

Defines the priority of the port. In the case of multiple network paths with identical path costs, the priority value decides which port is used. If priority values are identical then the port to be taken is the first in the list.



So as to maintain compatibility with RSTP, this value may only be adjusted in steps of 16 owing to the fact that RSTP uses only the upper 4-bits of this 16-bit value.

- Path-Cost-Override

This parameter controls the priority of paths with equal value. The value set here is used to make the selection instead of the computed path costs.

- Special values: 0 switches path-cost override off.
- Default: 0

## 7.18.4 Status reports via the Spanning Tree Protocol

The current STP values can be viewed via Telnet or WEBconfig in the LAN Bridge Status.

WEBconfig: LCOS-menu tree / Status / LAN-Bridge / Spanning-Tree

### General status information

- Bridge ID

This is the ID for the device that is being used by the Spanning Tree algorithm. It is composed of the user-defined priority (upper 16 bits) and the device MAC address (lower 48 bits).

- Root Bridge

The ID for the device that is currently elected root bridge.

- Root Port

The port that can be used to reach the root bridge from this device. If the device itself is the root bridge, it is displayed with the special value '255'.

- Root Path Cost

The path costs of all hops added together in order to reach the root bridge from this device.

- Protocol version

The protocol version currently set for determining network topology.

- Path Cost Computation

The protocol version currently set for computing path cost.

- Bridge priority

Current setting for bridge priority.

### Information in the port table

The port table can be used to inspect the following values for all available ports (LAN, wireless LAN, point-to-point connections).

- Priority

The priority of this port taken from the port configuration

- Status

The current status of the port:



- Disabled: no packets can be sent or received through this port. This occurs when the port has either been disabled manually or when it has a negative link status.
- Listening: Intermediate state on the way to enabling. Only Spanning Tree packets are listened to, data packets are ignored and are also not forwarded to this port.
- Learning: Further intermediate state. As opposed to 'listening' additional MAC addresses from data packets entering this port are learned but data packets are still not forwarded.
- Forwarding: the port is completely active, data packets are received and forwarded in both directions.
- Blocking: Spanning Tree has identified this port to be redundant and disabled it for data traffic.

- **Root**

The ID of the root bridge that can be reached through this port.

- **Bridge**

This is the ID of the bridge through which the root bridge can be reached.

- **Costs**

This value defines the 'costs' for this port. The value is determined by the port technology (Ethernet, WLAN, etc.) and the bandwidth. Examples of values used are:

Transfer technology	Costs of Classic Spanning Tree	Costs of Rapid Spanning Tree
Ethernet 10 MBit	100	2000000
Ethernet 100 MBit	19	200000
Ethernet 1000 MBit	4	200000
WLAN 2 MBit	500	12500000
WLAN 11 MBit	140	4000000
WLAN 54 MBit	35	900000
WLAN 108 MBit	25	450000

 If path costs for a port were manually entered, then the configured value appears in this column.

### Information in the RSTP port statistics

The RSTP port table can be used to inspect the following values for all available ports (LAN, wireless LAN, point-to-point connections).

- **Role**

Root or Non-root bridge

- **Learning**

Port in learning state.

- **Forwarding**

Port in forwarding state.

- **Edge port**

Port defined as an edge port.

- **Protocol version**

Classic or Rapid

- **Costs**

Setting for this port's cost

## 7.19 The Action table

### 7.19.1 Introduction

The action table controls actions triggered when there is a change in status of WAN connections. WAN connections include direct connections to an Internet provider, and also VPN connections based on this, such as those used to connect a branch office to a main office. Every action is linked with a condition that describes the change in status of the WAN connection (establishment, termination, failure or establish failure). Actions can be any of the commands available at the Telnet console. Furthermore, actions can transmit messages by e-mail or SYSLOG, send an HTTP request, or transmit a DNS request. Different variables allow information such as the current IP address, the name of the device, or an error message to be integrated into the action.

### 7.19.2 Actions for Dynamic DNS

Systems with dynamic IP addresses can be made available for access via the WAN, for example via the Internet, by using the services of commercially available dynamic DNS servers. Servers offering these services can assign the current IP address of a device to its FQDN name (Fully Qualified Domain Name, e. g. "http://MyLANCOM.dynDNS.org").

The advantage is obvious: If you wish to carry out remote maintenance via WEBconfig/HTTP, the only information you need is the dynamic DNS name. Also, a DynDNS name can be used to establish VPN connections between remote stations that have changing IP addresses.

In order for the current IP address to match with the DynDNS name at all times, the IP address recorded on the DynDNS server must be constantly updated. This change is triggered by a dynamic DNS client.

- The DynDNS server, maintained by a DynDNS service provider on the Internet, is in contact with the Internet DNS servers.
- The Dynamic DNS client can run on a workstation as a separate client program. As an alternative, a dynamic DNS client is integrated into the LANCOM. It can make contact to any one of a number of dynamic-DNS service providers and, assuming that a user account has been set up, automatically update its current IP address for the DNS name translation.

#### Dynamic DNS client on the workstation

Dynamic DNS providers support a range of PC client programs that use various methods to determine the IP address currently assigned to a LANCOM. A change in IP address is communicated to the appropriate dynamic DNS server.

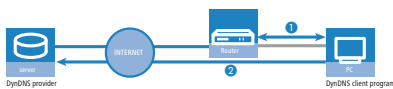

The current WAN-side IP address of a LANCOM can be read from the following address and entered into a client program:

`http://<Address of the LANCOM>/config/1/6/8/3/`

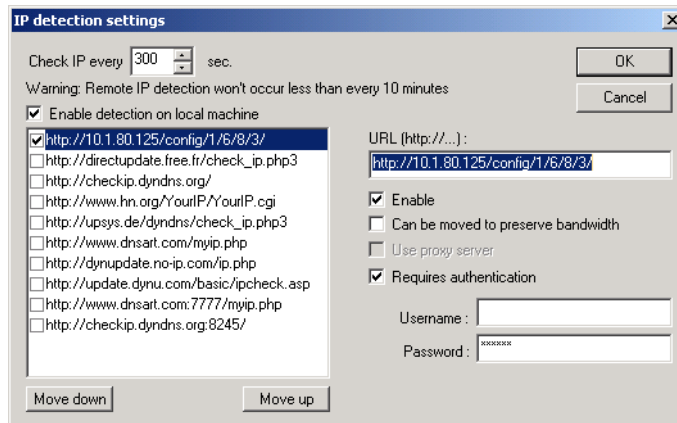

## Dynamic-DNS client in the LANCOM via HTTP

Alternatively the LANCOM can transmit the current WAN IP to the DynDNS provider directly:



An action is defined for this which, for example, automatically sends an HTTP request to the DynDNS server each time a connection is established. The necessary information is transferred via the DynDNS account, so triggering an update of the registration. An HTTP request of this type from DynDNS.org appears as follows:

- `http://Username:Password@members.dyndns.org/nic/update?system=dyndns&hostname=%h&myip=%a`

The host name of the action and the LANCOM's current IP address are sent to an account at DynDNS.org as specified by a username and password, and the appropriate entry is updated.

The settings necessary for this can be adjusted easily by using the Setup Wizards in LANconfig:

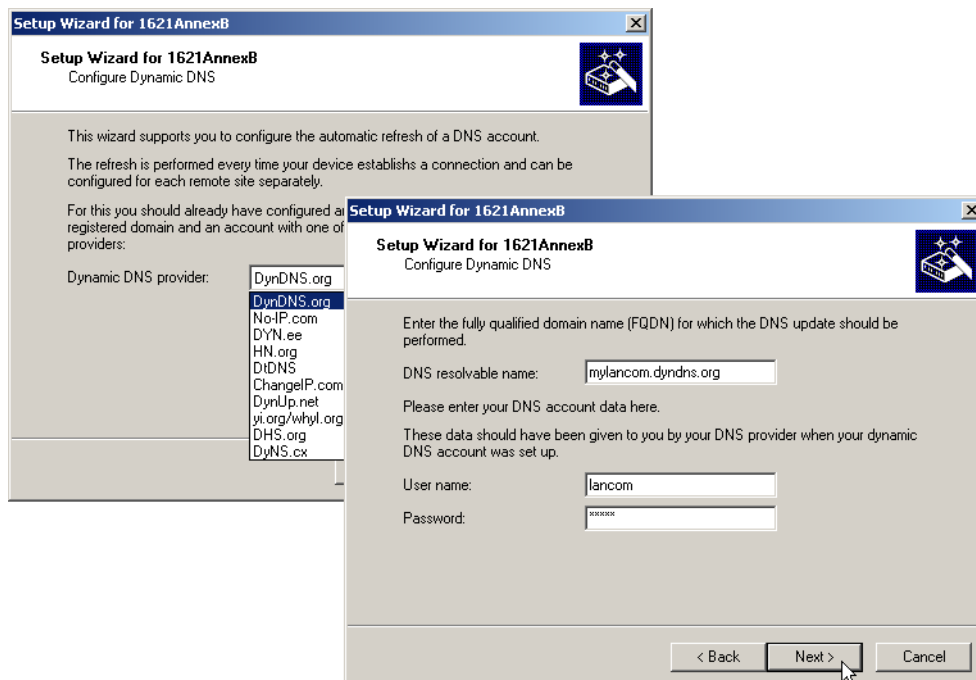

The Setup Wizard supplements the basic action with further provider-specific parameters, which are not described here. Apart from that, the Setup Wizard creates additional actions that control the LANCOM in case the update does not succeed the first time.

### Dynamic-DNS client in the LANCOM via GnuDIP

As an alternative to using a simple HTTP request to update DynDNS information, some services make use of the GnuDIP protocol. The GnuDIP protocol is based on a challenge-response mechanism:

1. The client opens the connection to the GnuDIP server.
2. The server responds with a random value calculated for the session.
3. The client uses the random value and the password to create a hash value, which is returned to the server.
4. The server checks this hash value and reports its result by sending a number back to the client.

The GnuDIP protocol can exchange the messages between the client and server either via a simple TCP connection (standard port 3495) or as a CGI script running on an Internet server. The version using an HTTP request from a CGI script has the advantage that no additional ports have to be opened on the GnuDIP, and also that HTTP offers protection from passive interception and offline dictionary attacks.

Requests to a GnuDIP server are triggered by the LANCOM with an action in the following form:

- `gnudip://<srv>[:port][/path]?<parameter>`
  - `<srv>` – The GnuDIP server address.
  - `[:port]` – Specifying the port is optional. If it is not defined, default values are taken instead (3945 for TCP, 80 or 443 for HTTP/HTTPS).
  - `[/path]` – Path information is only required by HTTP/HTTPS to define the location where the CGI script is stored.

The following parameters are extensions to the request:

- `method=<tcp|http|https>` – Selects the protocol to be used for the transmission between the GnuDIP server and client. Only one protocol can be selected here.
- `user=<username>` – Specifies the user name for the account on the GnuDIP server.
- `pass=<password>` – Specifies the password for the account on the GnuDIP server.
- `domn=<domain>` – Specifies the DNS domain containing the DynDNS entry.
- `reqc=<0|1|2>` – Defines the action that is triggered by the request. Action `<0>` sends the server a dedicated IP address that is to be used for the update. Action `<1>` deletes a DynDNS entry. Action `<2>` triggers an update, although no IP address is transmitted to the server. Instead, the server carries out the update with the IP address of the GnuDIP client.
- `addr=<address>` – Specifies the IP address that an action with the parameter `<0>` is to use for updating the DynDNS entry. If this is unspecified in a `<0>` action, the request is treated as a `<2>` action.

With the GnuDIP protocol, the host name that is to be registered corresponds to the user name sent to the server. If, for example, the username is "myserver" and the DNS domain is "mydomain.org", then the DNS name "myserver.mydomain.org" is registered.

For example, the following action executed via the GnuDIP protocol updates the DynDNS entry at a DynDNS provider with the current IP address of the LANCOM (%a) as soon as a connection is established:

- `gnudip://gnudipsrv?method=tcp&user=myserver&domn=mydomain.org &pass=password&reqc=0&addr=%a`

Use the following action to delete a DynDNS entry, for example once the connection has been terminated:

- `gnudip://gnudipsrv?method=tcp&user=myserver&domn=mydomain.org &pass=password&reqc=1`

The line-break is for legibility only and is not to be entered into the action.

In response to the request, the GnuDIP server returns one of the following values to the GnuDIP client (assuming that the connection between server and client was established):

- 0 – The DynDNS entry was updated successfully.
- 0:address – The DynDNS entry was successfully updated with the specified address.

- 1 – Authentication at the GnuDIP server failed.
- 2 – The DynDNS entry was deleted successfully.

These responses can be processed by the LANCOM's actions to trigger further actions if necessary.

### 7.19.3 Further example actions

#### Broken connection alert as an SMS to a mobile telephone

The placeholder %t allows the current time of an event to be incorporated into a message. For example, an alert about the interruption of an important VPN connection can be sent by e-mail or as an SMS to a system administrator's mobile telephone.

The following requirements have to be met for messaging:

- The status of the VPN connection must be monitored, for example by means of "dead-peer-detection" (DPD).
- The LANCOM has to be configured as an NTP client in order to have the current system time.
- An SMTP account must be set up for transmitting e-mails.

Once these requirements are fulfilled, messaging can be set up. This is done with a new entry in the action table; e. g. with LANconfig under **Communication / General / Action table**.

Select the remote site for the relevant connection. As Condition select 'Broken' and enter the action as the transmission of an e-mail.

```
mailto:admin@mycompany.com?subject=VPN connection broken at %t?body=VPN connection to Subsidiary 1 was broken.
```

If the connection is broken, this action sends an e-mail to the administrator with the time of the event in the subject line.

! If the mail is sent to an appropriate Mail2SMS gateway the alert can be sent directly to a mobile telephone.

! For complex scenarios with several subsidiaries, each of the remote sites is given a corresponding entry in the central LANCOM. For monitoring the central device itself, an action is entered into a device at one of the subsidiaries. In this way the administrator receives an alert even if the VPN gateway at the central location fails, which could potentially prevent any messages from being transmitted.

#### Example: Suppress messaging in case of re-connects with a DSL connection

Some providers interrupt the DSL connection used for the VPN connections once every 24 hours. To avoid informing the administrator of these regular interruptions, messaging can be disabled at the time when the re-connect occurs.

First of all an action is required to force the re-connect to occur at a fixed time; generally at night when the Internet connection is not in use. The entry defines, for example, 03:00h and the Internet connection is broken with the command `do other/manual/disconnect internet`.

With two more cron commands `set /setup/wan/action-table/1 yes/no` the corresponding entry in the action table is switched off three minutes before 03:00h and switched on again three minutes after 03:00h. The number 1 following the path to the action table is an index that stands for the first entry in the table.

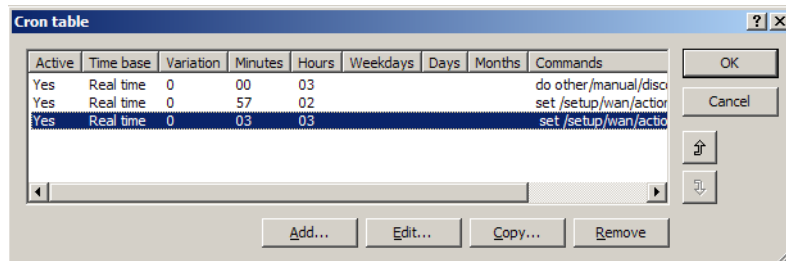

## 7.19.4 Configuration

Changes with LCOS 7.6:

- "Failure" as a condition for a change in status of the WAN connection
- "Establish failure" as a condition for a change in status of the WAN connection
- GnuDIP protocol support

With the action table you can define actions that are executed when the status of a WAN connection changes.

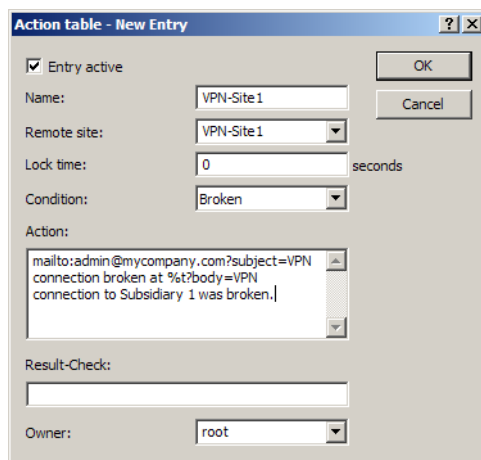

LANconfig: Communication / General / Action table

WEBconfig: Setup / WAN / Action table

- Index

The index gives the position of the entry in the table, and thus it must be unique. Entries in the action table are executed consecutively as soon as there is a corresponding change in status of the WAN connection. The entry in the field "Check for" can be used to skip lines depending on the result of the action. The index sets the position of the entries in the table (in ascending order) and thus significantly influences the behavior of actions when the option "Check for" is used. The index can also be used to actuate an entry in the action table via a cron job, for example to activate or deactivate an entry at certain times.

- Active

Activates or deactivates this entry.

- Host name

Action name. This name can be referenced in the fields "Action" and "Check for" with the place holder %h (host name).

- Remote site

A change in status of this remote site triggers the action defined in this entry.

- Lock time (max. 10 characters)

Prevents this action from being repeated within the period defined here in seconds.

- Condition

The action is triggered when the change in WAN-connection status set here occurs.

Possible values:

- Establish – The action is triggered when the connection has been established successfully.
- Disconnect – The action is triggered when the device itself terminates the connection (e.g. by manual disconnection or when the hold time expires).
- End – The action is triggered on disconnection (whatever the reason for this).
- Failure – This action is triggered on disconnects that were not initiated or expected by the device.
- Establish failure – This action is triggered when a connection establishment was started but not successfully concluded.

- Action (max. 250 characters)

Here you describe the action that should be executed when there is a change in the status of the WAN connection. Only one action can be triggered per entry.

Possible values for the actions (max. 250 characters):

- exec: – This prefix initiates any command as it would be entered at the Telnet console. For example, the action "exec:do /o/m/d" terminates all current connections.
- dnscheck: – This prefix initiates a DSN name resolution. For example, the action "dnscheck:myserver.dyndns.org" requests the IP address of the indicated server.
- http: – This prefix initiates an HTTP-get request. For example, you can use the following action to execute a DynDNS update at dyndns.org:  
http://username:password@members.dyndns.org/nic/update?system=dyndns&hostname=%h&myip=%a The meaning of the place holders %h and %a is described below.
- https: – Like "http:", except that the connection is encrypted.
- gnudip: – This prefix initiates a request to the corresponding DynDNS server via the GnuDIP protocol. For example, you can use the following action to use the the GnuDIP protocol to execute a DynDNS update at a DynDNS provider: gnudip://gnudipsrv?method=tcp&user=myserver&domn=mydomain.org  
&pass=password&reqc=0&addr=%a The line-break is for legibility only and is not to be entered into the action. The meaning of the place holder %a is described below.
- repeat: – This prefix together with a time in seconds repeats all actions with the condition "Establish" as soon as the connection has been established. For example, the action "repeat:300" causes all of the establish actions to be repeated every 5 minutes.
- mailto: – This prefix causes an e-mail to be sent. For example, you can use the following action to send an e-mail to the system administrator when a connection is terminated: mailto:admin@mycompany.de?subject=VPN  
connection broken at %t?body=VPN connection to Branch Office 1 was terminated.

Optional variables for the actions:

- %a – WAN IP address of the WAN connection relating to the action.
- %H – Host name of the WAN connection relating to the action.
- %h – Like %H, except the hostname is in small letters
- %c – Connection name of the WAN connection relating to the action.
- %n – Device name
- %s – Device serial number

- %m – Device MAC address (as in Sysinfo)
- %t – Time and date in the format YYYY-MM-DD hh:mm:ss
- %e – Description of the error that was reported when connection establishment failed.

The result of the actions can be evaluated in the "Check for" field.

Default:

- Blank
- Check for

The result of the action can be evaluated here to determine the number of lines to be skipped in the processing of the action table.

Possible values for the actions (max. 50 characters):

- contains= – This prefix checks if the result of the action contains the defined string.
- isequal= – This prefix checks if the result of the action is exactly equal to the defined string.
- ?skipiftrue= – This suffix skips the defined number of lines in the list of actions if the result of the "contains" or "isequal" query is TRUE.
- ?skipiffalse= – This suffix skips the defined number of lines in the list of actions if the result of the "contains" or "isequal" query is FALSE.

Optional variables for the actions:

- As with the definition of the action.

Example:

- A DNS check queries the IP address of an address in the form "myserver.dyndns.org". The check "contains=%a?skipiftrue=2" allows the two following entries in the action table to be skipped if the IP address found by the DNS check agrees with the current IP address (%a) of the device.

- Owner

Owner of the action. The exec actions are executed with the rights of the owner. If the owner does not have the necessary rights (e.g. administrators with write access) then the action will not be carried out.

## 7.20 Using the serial interface in the LAN

### 7.20.1 Introduction

In the IT field, COM port servers (also known as serial port servers) are devices that transport data between TCP and serial connections. There are many applications.

- Networking of devices with a serial interface but without a network interface.
- Remote maintenance of devices that can only be configured via a serial interface.
- Virtual extension of a serial connection between two devices with serial interfaces over a network.

Most LANCOM devices feature a serial interface that can be used to carry out configurations or to connect to a modem. In some cases the interface is used for neither of these scenarios, and yet a COM port server is required in the vicinity of the device. In such cases the LANCOM can use its serial interface as a COM port server, thus saving the costs for an external COM port server. If this application focuses on the serial configuration interfaces of these devices, additional serial interfaces can be provided by some models in combination with suitable CardBus or USB adapters. This enables multiple instances of the COM port server to be operated in one device.



## 7.20.2 Operating modes

A COM port server has two operating modes:

- Server mode: The COM port server waits for requests from a defined TCP port to establish TCP connections. The mode is used for remote maintenance, for example.
- Client mode: As soon as a device connected to the serial interface becomes active, the COM port client opens a TCP connection to a preset remote site. This operating mode is used, for example, for devices that have just one serial interface but requiring network access.

In both of these cases a transparent connection is set up between the serial interface and the TCP connection. Data packets received at the serial interface are forwarded to the TCP connection, and vice versa. A common server-mode application is to install a virtual COM port driver at the remote site which connects to the COM port server. Drivers of this type allow applications running at the remote site to use the TCP connection as if it were an additional COM port. The IETF RFC 2217 standard sets down the Telnet WILL/DO protocol extensions, which transmit the negotiations for the serial connection (bitrate, data and stop bits, handshake) to the COM port server. The use of this protocol is optional, so practical default values can be set in the COM port server.

## 7.20.3 Serial interface configuration

The serial interfaces in the LANCOM can be used for various applications, for example for the COM port server or as a WAN interface. The Devices table allows individual serial devices to be assigned to certain applications. As soon as a HotPlug-capable USB adapter is detected, a new entry for the serial interface provided by this USB adapter is created automatically in this table. This automation simplifies the configuration of the serial devices. An exception is the built-in serial interface, which is used for configuration purposes as standard. Entries can be added to the Devices table manually to use this interface for the COM port server or WAN applications.

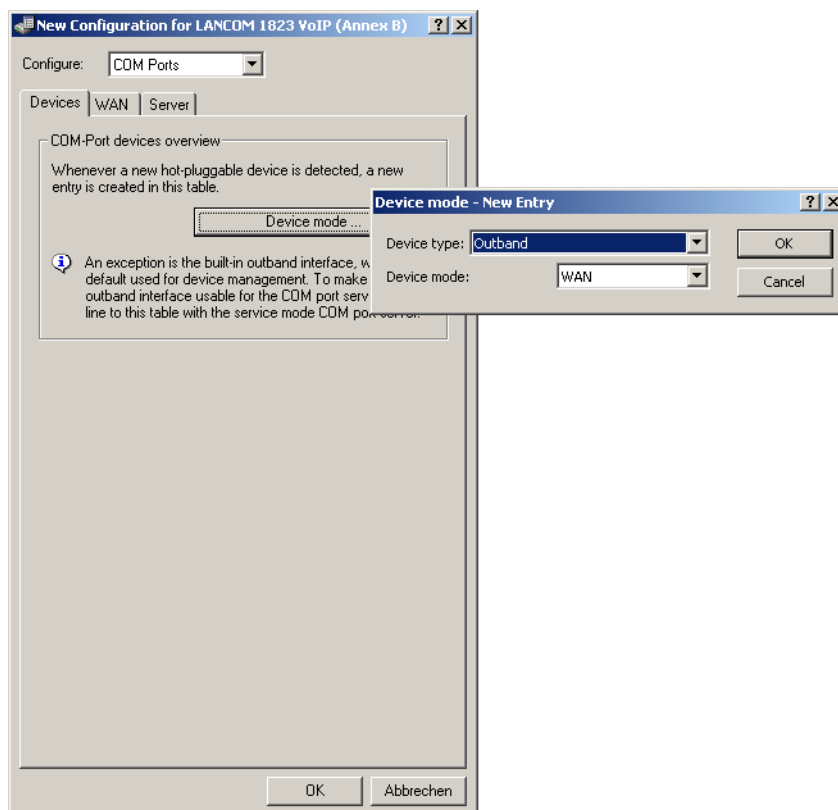

LANconfig: COM ports / Devices / Device operating mode

WEBconfig: Setup / COM-Ports / Devices

- Device type

Selects a serial interface from the list of those available in the device.

- Service

Activation of the port in the COM port server.

## 7.20.4 Configuring the COM port server

Configuring the COM port server involves three tables. What all three tables have in common is that a certain port at a serial interface is identified by the values for device type and port number. Because some serial devices such as a CardBus card have multiple ports, the port to be used must be specified explicitly. For a device with just one port, such as with the serial configuration interface, the port number is set to zero.

### Operational settings

This table activates the COM port server at a port of a certain serial interface. Add an entry to this table to start a new instance of the COM port server. Delete an entry to stop the corresponding server instance. The switch Operating can be used to deactivate a server instance in the table.

When a server instance is created or activated, the other tables in the COM port configuration are searched for matching device type and port number values. If no suitable entry is found, the server instance takes workable default values.

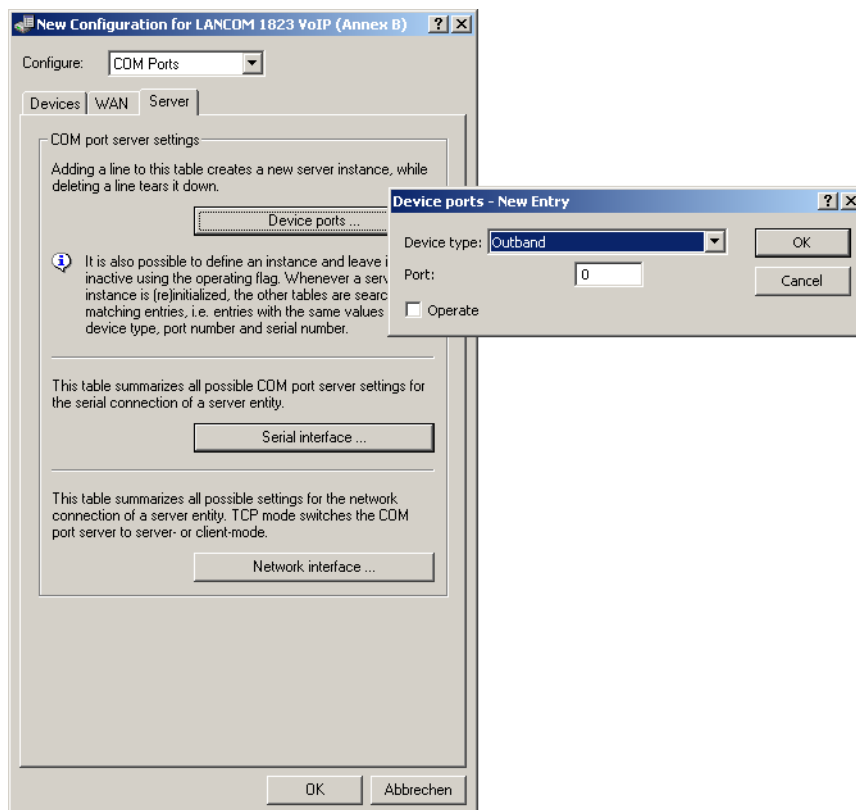

LANconfig: COM ports / Server / Device ports

WEBconfig: Setup / COM-Ports / COM-Port-Server / Devices

- Device type

Selects a serial interface from the list of those available in the device.

- Port number

Some serial devices such as the CardBus have more than one serial port. Enter the number of the port on the serial interface that is to be used for the COM-port server.

- Operating

Activates the COM port server on the selected port of the selected interface.

## COM-port settings

This table contains the settings for data transmission over the serial interface.

- ⓘ Please note that all of these parameters can be overwritten by the remote site if the RFC2217 negotiation is active. Current settings can be viewed in the status menu.

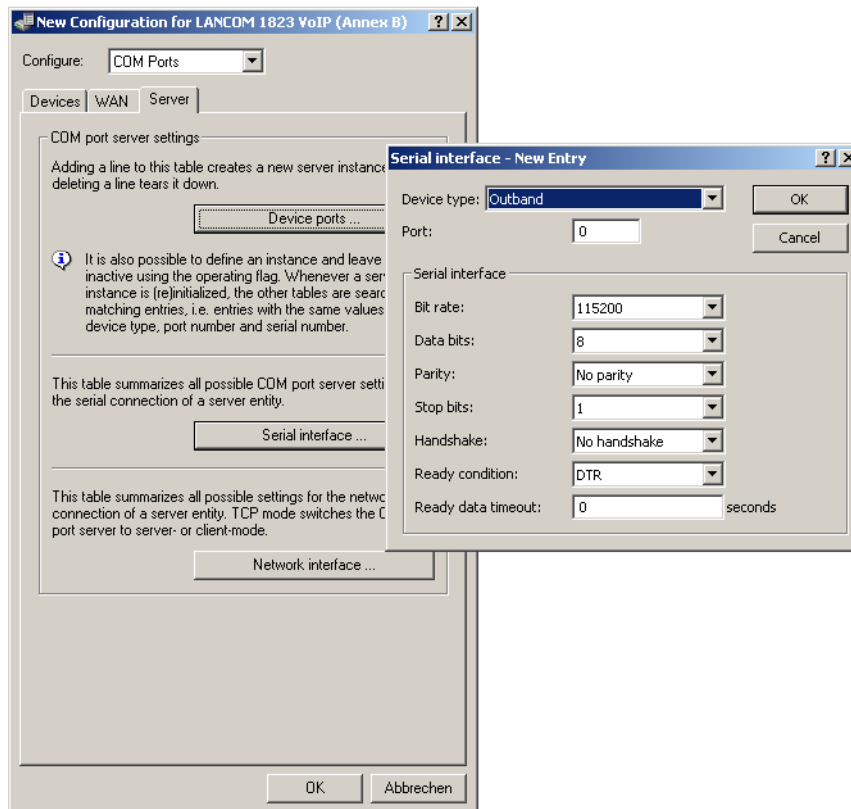

LANconfig: COM ports / Server / Serial interface

WEBconfig: Setup / COM-Ports / COM-Port-Server / COM-Port-Settings

- Device type

Selects a serial interface from the list of those available in the device.

- Port number

Some serial devices such as the CardBus have more than one serial port. Enter the number of the port on the serial interface that is to be used for the COM-port server.

- Bitrate

Bitrate used on the COM port

- Data bits:

Number of data bits.

- Parity

The checking technique used on the COM port.

- Stop bits

Number of stop bits.

- Handshake

The data-flow control used on the COM port.

- Ready condition

The ready condition is an important property of any serial port. The COM port server transmits no data between the serial port and the network if the status is not "ready". Moreover, the transition from the "ready" to the "not ready" states is used to establish and cancel TCP connections in client mode. There are two ways of determining whether the port is ready or not. In DTR mode (default) only the DTR handshake is monitored. The serial interface is considered to be ready for as long as the DTR line is active. In data mode, the serial interface is considered to be active for as long as it receives data. If no data is received during the timeout period, the port reverts to its not-ready status.

- Ready-Data-Timeout

The timeout switches the port back to the not-ready status if not data is received. This function is deactivated when timeout is set to zero. In this case the port is always ready if the data mode is selected.

## Network settings

This table contains all settings that define the behavior of the COM port in the network.

ⓘ Please note that all of these parameters can be overwritten by the remote site if the RFC2217 negotiation is active. Current settings can be viewed in the status menu.

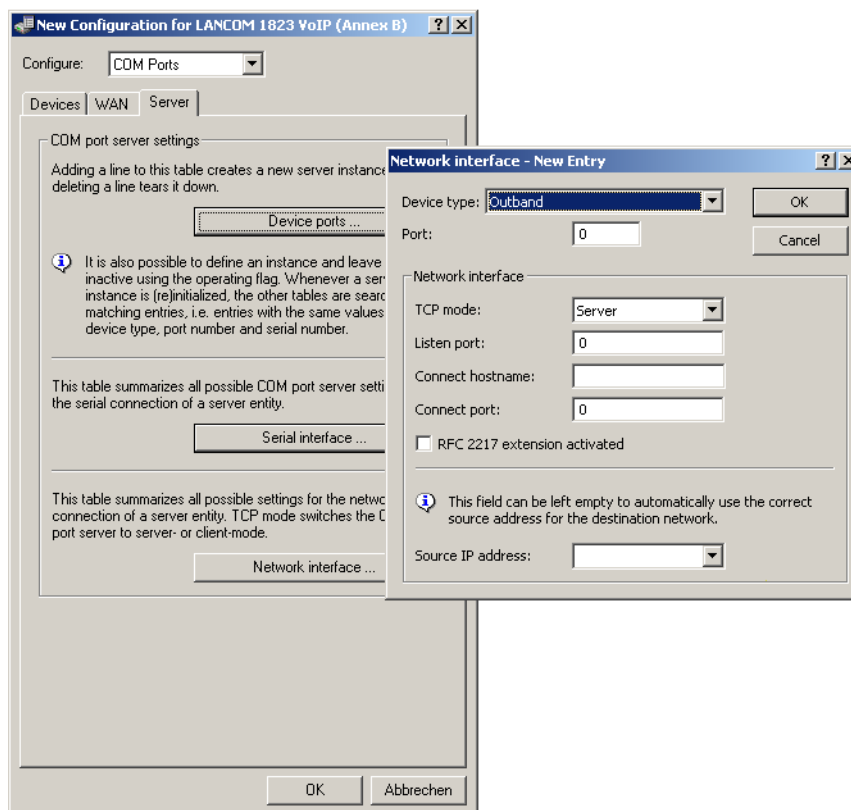

LANconfig: COM ports / Server / Network interface

WEBconfig: Setup / COM-Ports / COM-Port-Server / Network settings

- Device type

Selects a serial interface from the list of those available in the device.

- Port number

Some serial devices such as the CardBus have more than one serial port. Enter the number of the port on the serial interface that is to be used for the COM-port server.

- TCP mode

Each instance of the COM port server in server mode monitors the specified listen port for incoming TCP connections. Just one active connection is permitted per instance. All other connection requests are refused. In client mode, the instance attempts to establish a TCP connection via a defined port to the specified remote site, as soon as the port is ready. The TCP connection is closed again as soon as the port becomes unavailable. In both cases a LANCOM closes any open connections when the device is restarted.

- Listen port

The TCP port where the COM port in TCP server mode expects incoming connections.

- Connect host name

The COM port in TCP client mode establishes a connection to this host as soon as the port is in "Ready" status.

- Connect port

The COM port in TCP client mode uses this TCP port to establish a connection as soon as the port is in "Ready" state.

- Loopback address

The COM port can be reached at this address. This is its own IP address that is given as the source address when establishing connections. This is used to define the IP route to be used for the connection.

- RFC2217 extensions

The RFC2217 extensions can be activated for both TCP modes. With these extensions activated, the LANCOM uses the IAC DO COM-PORT-OPTION sequence to signal that it will accept Telnet control sequences. The COM port subsequently works with the corresponding options; the configured default values are overwritten. The port also attempts to negotiate the local echo and line mode for Telnet. Using the RFC2217 extensions with incompatible remote sites is not critical. Unexpected characters may be displayed at the remote site. A side effect of using the RFC2217 extensions may be that the port regularly carries out an alive check as Telnet NOPs are transmitted to the remote site.

## 7.20.5 WAN device configuration

The table with WAN devices is a status table only. All Hotplug devices (connected via USB or CardBus) enter themselves into this table.

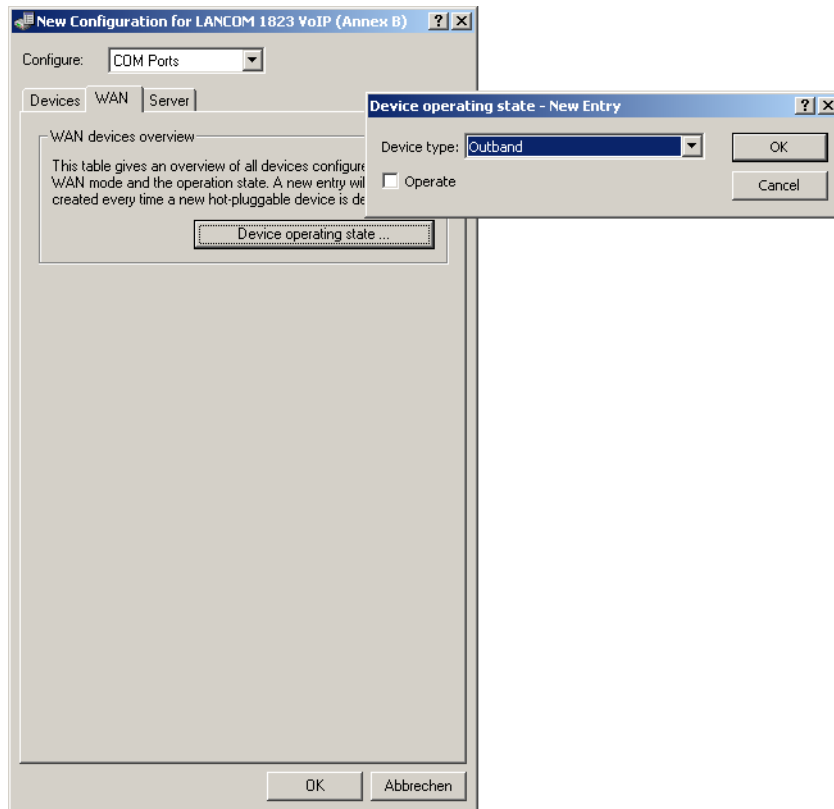

LANconfig: COM ports / WAN / Device operating state

WEBconfig: Setup / COM ports / WAN / Devices

- Device type
  - List of serial interfaces available in the device.
- Active
  - Status of connected device:

## 7.20.6 Serial connection status information

Various statistics and status values are recorded for every instance of the COM-port server. The serial port using the instance is indicated in the first two columns of the table—the values for device type and port number as entered during the configuration are displayed here.

### Network status

Telnet: Status / COM-Ports / COM-Port-Server / Network status

This table contains information on current and recent TCP connections.

- Device type
  - List of serial interfaces available in the device.
- Port number

The port number used for the COM port server on the serial interface.

- Connection status

Possible values:

- Connected: An active connection exists (server or client mode).
- Listening: This instance is working in server mode; no TCP connection is currently active.
- Not listening: In server mode, the specified TCP port could not be reserved for inbound connections, e.g. because it is already occupied by another application.
- Blank: This instance is working in client mode and the port is not ready. No TCP connection will be established now.
- Transfer: The port has reached the "ready" state; a connection is being established.

- Last error

In client mode this displays the reason for the last connection error. In server mode this value has no significance.

- Remote address:

Displays the IP address of the remote site for a successful TCP connection.

- Local port

Displays the local TCP port used for a successful TCP connection.

- Remote port

Displays the remote TCP port used for a successful TCP connection.

## COM-port status

This table displays the serial port status and the settings currently used by this port.

- Device type

List of serial interfaces available in the device.

- Port number

The port number used for the COM port server on the serial interface.

- Port status

- Possible values: Not available: The serial port is currently not available to the COM port server, for example because the USB or CardBus adapter has been removed or because it is being used by other functions in the LANCOM. Not ready: The serial port is available to the COM port server but is currently not ready for data transfer, for example because the DTR line is inactive. In the client state, no attempt is made to establish a connection as long as the port is in this state. Ready: The serial port is available and ready for data transfer. In the client state, an attempt is made to establish a TCP connection as soon as the port is in this state.



Please note that the port status is relevant in server mode, too. All TCP connection requests are accepted, although the COM port instance will only transfer data between the serial port and the network when the serial port has reached the "ready" state. The following columns display the settings that are currently in use on the serial port. These are either the values as configured or as set by the negotiations via the RFC2217 extensions.

- Bitrate

Bitrate used on the COM port

- Data bits:

Number of data bits.

- Parity

The checking technique used on the COM port.

- Stop bits  
Number of stop bits.
- Handshake  
The data-flow control used on the COM port.

### Byte counters

This table displays the inbound and outbound data packets at the serial port and on the network side.

---

 These values are not reset when the connection is opened or closed.

- Device type  
List of serial interfaces available in the device.
- Port number  
The port number used for the COM port server on the serial interface.
- Serial-Tx  
Number of bytes sent over the serial interface.
- Serial-Rx  
Number of bytes received over the serial interface.
- Network-Tx  
Number of bytes sent to the network.
- Network-Rx  
Number of bytes received from the network.

### Port-Errors

This table displays the serial port errors. These errors may indicate a faulty cable or errors in the configuration.

- Device type  
List of serial interfaces available in the device.
- Port number  
The port number used for the COM port server on the serial interface.
- Parity errors  
Number of errors due to a checksum mismatch.
- Framing errors  
Number of erroneous data packets.

### Connections

This table displays successful and failed TCP connections in both server mode and client mode.

- Device type  
List of serial interfaces available in the device.
- Port number  
The port number used for the COM port server on the serial interface.
- Server granted



Number of connections granted by the COM port server.

- Server rejected

Number of connections rejected by the COM port server.

- Client succeeded

Number of connections successfully established by the COM port client.

- Client DNS error

Number of connections that the COM port client could not establish due to DNS errors.

- Client TCP error

Number of connections that the COM port client could not establish due to TCP errors.

- Client-remote disconnects

Number of connections where the COM port was disconnected from the remote site.

### Delete values

This action deletes all values in the status tables.

## 7.20.7 COM-port adapters

Devices with serial interfaces can be connected to a LANCOM in the following ways:

Adapter	LANCOM devices
COM-port adapters	All those with a serial configuration interface
USB serial adapter	All those with a USB interface
CardBus serial adapter	All those with a CardBus slot
LANCOM modem adapter kit	All those with a serial configuration interface

The COM port adapter must be a two-way D-sub plug with the following PIN assignment:

Pin	Signal	Signal	Pin
2	RxD	TxD	3
3	TxD	RxD	2
4	DTR	DSR	6
5	GND	GND	5
6	DSR	DTR	4
7	RTS	CTS	8
8	CTS	RTS	7

## 7.20.8 Addition(s) to LCOS 7.80

### Serial COM-port enhancements

#### Introduction

The COM-port configuration has been enhanced with a number of parameters.

### Configuration

The additional parameters are located in the network settings for the COM port.

WEBconfig: LCOS menu tree / Setup / COM ports / COM-port server / Network settings

- Assume binary mode

Some network devices connected to a serial COM port transmit data structures which may be interpreted as control characters (CR/LF – carriage return / line feed). In the default setting, the COM-ports in LANCOM devices process this information to control the data flow. "Binary mode" instructs a COM port to forward the data in binary format and ignore any control characters.

Possible values:

- Yes, No.

Default:

- No.

- Newline conversion

Here you select the character to be output by the serial port when binary mode is activated.

This setting is independent of the application communicating via the serial port. If the port is connected to another LANCOM device, you can either enter CRLF here or just CR. This is because the outband interface of these devices expects a "carriage return" for the automatic determination of data-transfer speed. However, some Unix applications interpret CRLF as a prohibited double line feed character. In these cases enter either CR or LF.

Possible values:

- CRLF, CR, LF

Default:

- CRLF

---

 This setting is only relevant if binary mode is **deactivated** for this port.

- TCP keepalive

The RFC 1122 sets down a method of checking the availability of TCP connections, called TCP keepalive. An inactive transmitter queries the receive status from the remote station. If the TCP session to the remote site is available, then the remote responds with its receive status. If the TCP session to the remote site is not available, then the query is repeated for as long as it takes for the remote to respond with its receive status (after which a longer interval comes into play). As long as the basic connection functions, but the TCP session to the remote station is not available, then the remote station sends an RST packet which triggers the establishment of the TCP session by the requesting application.

Possible values:

- Inactive: TCP keepalive is not used.
- Active: TCP keepalive is active; only RST packets cause the disconnection of TCP sessions.
- Proactive: TCP keepalive is active, but the request for the receive status from the remote site is only repeated for the number of times defined under "TCP retry count". If this number of requests expires without a response with the receive status, then the TCP sessions is classified as "not available" and the application is informed. If an RST packet is received during the wait time, the TCP session will be disconnected prematurely.

Default:

- Inactive

---

 The setting "active" is recommended for server applications.

- TCP keepalive interval

This value defines the interval between sending requests for receive status if the first request is not affirmed. The associated timeout is defined as being interval/3 (max. 75 sec.).

Possible values:

- Maximum 10 characters

Default:

- 0

Special values:

- 0 activates the RFC 1122 default values (interval 7200 seconds, timeout 75 seconds).

- TCP retransmit timeout

Maximum time for the retransmission timeout. This timeout defines the the interval between checking TCP-connection status and reporting the result to the application using the TCP connection.

Possible values:

- 0 to 99 seconds.

Special values:

- 0 activates the RFC 1122 default value (60 seconds).

Default:

- 0



The maximum duration of the TCP-connection check is the product of TCP-retransmit-count and TCP-retry-count. The TCP application is only informed after the timeout for all attempts has expired. With the default values of 60 seconds timeout and max. 5 attempts, it can take up to 300 seconds before the application is informed about an inactive TCP connection.

- TCP retry count

The maximum number of attempts for checking TCP-connection status and reporting the result to the application using the TCP connection.

Possible values:

- 0 to 9

Special values:

- 0 activates the RFC 1122 default value (5 attempts).

Default:

- 0



The maximum duration of the TCP-connection check is the product of TCP-retransmit-count and TCP-retry-count. The TCP application is only informed after the timeout for all attempts has expired. With the default values of 60 seconds timeout and max. 5 attempts, it can take up to 300 seconds before the application is informed about an inactive TCP connection.

## 7.21 Addition(s) to LCOS 7.80

### 7.21.1 Routing of local services/ARP handling switchable

#### Introduction

Response packets for internal services (such as telnet, http/https, tftp, etc.) from the LANCOS to recipients in the Ethernet (LAN or WAN) were, prior to LCOS version 7.80, always sent directly to the corresponding requester. This meant, among other things, that devices could be detected from within any LAN.

As of LCOS version 7.80, a switch provides the option to initiate an ARP request to determine a specific route, instead of using the direct address.

If, for example, a LANCOS router should be detected by LANconfig without any knowledge of the LAN topology, then the older method would be preferable. In this case, the sender of the TFTP broadcast (in this case LANconfig/device search) receives a direct unicast response from the router.

In scenarios where LANs use changing virtual MAC and IP addresses (e.g. when VRRP components are used in the LAN), direct addressing may lead to errors if the redundancy protocol has adjusted the MAC/IP assignments. In such cases it is preferable to activate the "route internal services" option.

#### Configuration

The appropriate settings for IP routing can be used to route the LANCOS's internal services via the router.

WEBconfig: LCOS menu tree / Setup / IP router / Routing method

- Route internal services

This is where you select whether the internal services are to be directed via the router.

Possible values:

- Yes: Packets for internal services are directed via the router.
- No: Packets are returned straight to the sender.

Default:

- No

## 7.22 Addition(s) to LCOS 8.20

### 7.22.1 VDSL

#### Introduction

Some of the models in the LANCOS series of routers are equipped with a VDSL interface, which offers much higher data-transmission speeds than ADSL2+.

---

 Required for this is a VDSL2 connection as per ITU G.993.2.

## Configuration

To configure the operation of VDSL, the VDSL interface and the remote station are set up with the help of the corresponding WAN layers.

Follow these steps to prepare the device for VDSL2-based data communications:

1. Under /Setup/Interfaces/VDSL, set the VDSL-interface protocol to the VDSL protocol or automatic protocol selection.
2. Optionally: Go to /Setup/WAN/Layer and define a new WAN layer with the value "VDSL" in the field "Lay-1". Alternatively, you can use one of the predefined WAN layers for VDSL operation.
3. Under /Setup/WAN/DSL broadband peers, define a new remote site that uses the new WAN layer or one of the predefined WAN layers for VDSL operation.

 Setting the values "ATM-VPI" and "ATM-VCI" is meaningless for VDSL operation.

### Predefined WAN layer for VDSL

Devices with VDSL interfaces have predefined WAN layers for the configuration of the remote peers.

You can find the WAN layers under /Setup/WAN/Layer. The WAN layers for VDSL operation are set to the value "VDSL" in the "Lay-1" field.

WAN layer	Encaps.	Lay-3	Lay-2	L2-Opt.	Lay-1
T-VDSL	TRANS	PPP	PPPoE	None	VDSL
PPPOEOV	TRANS	PPP	PPPoE	None	VDSL
IPOEOV	ETHER	TRANS	TRANS	None	VDSL
DHCPOEOV	ETHER	DHCP	TRANS	None	VDSL

 The abbreviation \*OEOV stands for "over Ethernet over VDSL".

#### 2.2.4.6 Layer 1

In this field the lower section of the security layer (Data Link Layer) is configured.

**Telnet path:** /Setup/WAN/Layer

#### Possible values:

- AAL-5: ATM adaptation layer
- ETH: Transparent Ethernet as per IEEE 802.3.
- HDLC64K: Securing and synchronization of data transmission as per HDLC (in 7 or 8-bit mode).
- HDLC56K: Securing and synchronization of data transmission as per HDLC (in 7 or 8-bit mode).
- V110\_9K6: Transmission as per V.110 at max. 9,600 bps, e.g. for dialing in by HSCSD mobile phone
- V110\_19K2: Transmission as per V.110 at max. 19,200 bps
- V110\_38K4: Transmission as per V.110 at max. 38,400 bps
- Serial: For connections by analog modem or cellular modem with AT interface. The modem can be connected to the device at its serial interface (outband) or to a USB interface by means of a USB-to-serial adapter. Some models feature a CardBus slot that accommodates suitable cards. Some models have an internal integrated modem.
- Modem: For connections via the internal modem emulation when operating as a V.90 host modem over ISDN. Operation of the internal modem may require an additional software option for the device.
- VDSL: VDSL2 data transmission as per ITU G.993.2

**Default:** HDLC64K

 The range of available values depends on the hardware model at hand.

### 2.23.8 VDSL

This table contains an entry for each VDSL interface available in the device with the choice of protocol.

**Telnet path:** Setup/Interfaces/

#### 2.23.8.1 Interface

Select a VDSL interface for configuration.

**Telnet path:** /Setup/Interfaces/VDSL

**Possible values:**

- Select from the VDSL interfaces available in the device.

#### 2.23.8.2 Protocol

This item allows you to select the protocol for the VDSL interface.

**Telnet path:** /Setup/Interfaces/VDSL

**Possible values:**

- Auto: VDSL and all ADSL modes
- VDSL: VDSL only
- ADSL: All ADSL modes
- ADSL2+: ADSL2+ (G.992.5) only
- ADSL2: ADSL2 (G.992.3) only
- ADSL1: G.DMT (G.992.1) and also T1.413 with Annex-A

**Default:** Auto

### VDSL traces

The following traces enable you to check the status of the VDSL connections:

- trace + VDSL-Status: Information on the state of the VDSL connection.
- trace + VDSL-Data: Information about data communications over the VDSL connection.
- trace + VDSL-CTRL: Information on the communications between LCOS and the integrated VDSL modem.
- trace + VDSL: Starts all VDSL traces at once.

### VDSL status messages

The following tables contain the status messages relating to VDSL operation:

- The tables /Status/Connection, /Status/Info connection, /Status/Layer connection, /Status/Call information and /Status/Channel, and also various other tables under /Status/WAN and /Status/PPP, contain information about the device's connections. The interface referred to by these tables is indicated in the "Ifc" field. A connection in VDSL mode is indicated by "Ifc" fields containing the values "VDSL-1" to "VDSL-8". In case of error, the channel statistics contain the value "VDSL-ERR".
- The layer-1 setting being used is indicated by the entries in the field "Lay-1" of the table /Status/Layer connection. A connection in VDSL mode is indicated by the value "VDSL" in the "Lay-1" field.

The VDSL status messages are described in separate sections.

### 1.75 VDSL

This menu contains the following values for information about VDSL operation:

- Line status
- Line type
- VDSL profile
- Standard
- ATM-VPI
- ATM-VCI
- ATM mux mode
- Downstream rate (kbps)
- Upstream rate (kbps)
- Downstream SNR (dB)
- Upstream SNR (dB)
- Downstream attenuation (dB)
- Upstream attenuation (dB)
- INP downstream symbols
- INP upstream symbols
- Interleave downstream (ms)
- Interleave upstream (ms)
- Attainable downstream data rate (kbps)
- Attainable upstream data rate (kbps)
- DSLAM chip set vendor
- DSLAM vendor
- DSLAM version
- DSLAM serial number

**Telnet path:** /Status



The command "retrain" triggers a resynchronization of the VDSL interface.

#### 1.75.12 Connection history

This table contains information about current VDSL connections and previous VDSL connections since the device was last booted. It has the following columns:

- Index
- Sync time
- Disconnect time
- Standard
- VDSL profiles
- Reason
- DS data rate
- US data rate
- DS-SNR
- US-SNR
- DS attenuation
- US attenuation

**Telnet path:** /Status/VDSL/

### 1.75.25 Advanced

This menu contains the following values for advanced information about VDSL operation:

- Line state
- Standard
- VDSL profiles
- DSLAM chip set manufacturer
- DSLAM manufacturer
- DSLAM version
- DSLAM serial number
- DS data rate (kbps)
- DS attainable data rate (kbps)
- DS SNR margin (dB)
- DS line attenuation (dB)
- DS INP symbols
- DS interleave (ms)
- DS CRC errors
- DS FEC errors
- DS ATM HEC errors
- DS data path CRCp errors
- DS data path CRCnp errors
- DS data path CVP errors
- DS data path CVnp errors
- DS ATM idle bit errors
- DS received ATM cells
- US data rate (kbps)
- US attainable data rate (kbps)
- US SNR margin (dB)
- US line attenuation (dB)
- US INP symbols
- US interleave (ms)
- US CRC errors
- US FEC errors
- US ATM HEC errors
- US data path CRCp errors
- US data path CRCnp errors
- US data path CVp errors
- US data path CVnp errors
- US ATM idle bit errors
- US received ATM cells
- Transmitted ATM cells

**Telnet path:** /Status/VDSL/



The command "retrain" triggers a resynchronization of the VDSL interface.

### 1.75.500 Modem

This menu contains the following values for information about the status of the integrated VDSL modem:

- Modem status



- Options
- Memory test
- Link
- Last error
- VDSL firmware
- ADSL POTS firmware
- ADSL ISDN firmware
- DSL API version
- DSP firmware version
- Hardware version
- Chip set type
- Driver version

**Telnet path:** /Status/VDSL/



You can restart the integrated VDSL modem with the command "reboot modem".

## 7.23 Addition(s) to LCOS 8.80

### 7.23.1 Default mode in the DSLoL interface

As of LCOS version 8.80, the DSLoL interface is set to the default mode 'Exclusive'.

#### Additions to the Setup menu

##### Mode

This item selects the mode in which the WAN interface is operated. In automatic mode, all PPPoE frames and all data packets belonging to a connection established over the DSLoL interface (as configured in the IP parameter list) are routed via the DSLoL interface (WAN). All other data packets are treated as normal LAN packets. In exclusive mode, the LAN interface operates as a WAN interface only.

##### SNMP ID:

2.23.4.6

##### Telnet path:

**Setup > Interfaces > DSLoL-Interface**

##### Possible values:

Auto

Exclusive

##### Default:

Exclusive

## 8 Firewall

For most companies and many private users a work without the Internet is no longer conceivable. E-mail and web are indispensable for communication and information search. But each connection of the workstations from the own, local network to the Internet represents however a potential danger: Unauthorized users can try to see your data via this Internet connection, to modify it or to manipulate your PCs.

Therefore this chapter covers an important topic: the firewall as defensive measure against unauthorized access. Besides a brief introduction to the topic of Internet security, we show you which protection a LANCOM is able to offer you by right configuration and how to make the needed specific settings.

### 8.1 Threat analysis

To plan and to realize suitable measures to guarantee security, it is advisable to know first all possible sources of danger:

- Which imminent dangers exist for the own LAN resp. the own data?
- Which are the ways intruders take for the access to your network?

---

 We denote the intrusion into protected networks in the following as "attack" according to the general usage, and the intruder thus as "attacker".

#### 8.1.1 The dangers

The dangers in the Internet arise in principle from completely different motives. On the one hand the perpetrators try to enrich themselves personally or to damage the victims systematically. By the ever increasing know-how of the perpetrators, the "hacking" became already a kind of sports, in which young people often measure who takes at first the hurdles of Internet security.

Regardless of the individual motivation, the intention of the perpetrators mostly leads to the following aims:

- Inspect confidential information such as trade secrets, access information, passwords for bank accounts etc.
- Use of LAN workstations for purposes of the attackers, e. g. for the distribution of own contents, attacks to third workstations etc.
- Modify data of LAN workstations, e. g. to obtain even further ways for access.
- Destroy data on the workstations of the LAN.
- Paralyze workstations of the LAN or the connection to the Internet.

---

 We restrict ourselves in this section to the attacks of local networks (LAN) resp. to workstations and servers in such LANs.

#### 8.1.2 The ways of the perpetrators

In order to undertake their objectives, the perpetrators need at first a way to access your PCs and data. In principle, the following ways are open as long as they are neither blocked nor protected:

- Via the central Internet connection, e. g. via routers.
- Via decentral connections to the Internet, e. g. modems of single PCs or mobile phones on notebooks.
- Via wireless networks operating as a supplement to wired networks.

---

 In this chapter we only deal with the ways via the central Internet connection, via the router.

! For hints on the protection of wireless networks, please refer to the respective chapters of this reference manual resp. of the appropriate device documentation.

### 8.1.3 The methods

Normally strangers have of course no access to your local area network or to the workstations belonging to it. Without the appropriate access data or passwords nobody can thus access the protected area. If spying out of these access data is not possible, the attackers will try another way to achieve their goals.

A fundamental starting point is to smuggle data on one of the allowed ways for data exchange into the network, which opens from the inside the access for the attacker. Small programs can be transferred on a computer by appendices in e-mails or active contents on web pages, e.g., in order to lead afterwards to a crash. The program uses the crash to install a new administrator on the computer, which can then be used from distance for further actions in the LAN.

If the access via e-mail or www is not possible, the attacker can also look out for certain services of servers in the LAN, which are useful for his purposes. Because services of the servers are identified over certain ports of the TCP/IP protocol, the search for open ports is also called "port scanning". On the occasion, the attacker starts an inquiry for particular services with a certain program, either generally from the Internet, or, only on certain networks and unprotected workstations, which in turn will give the according answer.

A third possibility is to access an existing data connection and use it as a free-rider. The attacker observes here the Internet connection of the victim and analyses the connections. Then he uses e. g. an active FTP connection to smuggle his own data packets into the protected LAN.

A variant of this method is the "man-in-the-middle" attack. The attacker observes here first the communication of two workstations, and gets then in between.

### 8.1.4 The victims

The question about the degree of exposure for an attack influences to a considerable degree the expenditure one wants to or must meet for defending. In order to assess whether your network would be particularly interesting for an attacker as a potential victim, you can consult the following criteria:

- Particularly endangered are networks of common known enterprises or institutions, where valuable information is suspected. Such information would be e.g. the results of research departments, which are gladly seen by industrial spies. Or, on the other hand, bank servers, on which big money is distributed.
- Secondly, also networks of smaller organizations are endangered, which perhaps are only interesting to special groups. On the workstations of tax consultants, lawyers or doctors do slumber certainly some information quite interesting for third persons.
- Last but not least also workstations and networks are victims of attackers, which obviously offers no use for the attackers. Just the "script kiddies" testing out their possibilities by youthful ambition are sometimes just searching for defenceless victims in order to practise for higher tasks.

The attack against an unprotected, apparently not interesting workstation of a private person can also serve the purpose to prepare a basis for further attacks against the real destination in a second step. The workstation of "no interest" becomes source of attacks in a second step, and he attacker can disguise his identity.

All things considered, we can resume that the statistical probability for an attack to the network of a global player of the industry may be higher than to a midget network of the home office. But probably it is only a matter of time that a defenceless workstation installed in the Internet will - perhaps even accidentally - become the victim of attacks.

## 8.2 What is a Firewall?

The term "Firewall" is interpreted very differently. We want to define at this point the meaning of "Firewall" within the boundaries of this reference manual.

A Firewall is a compilation of components, which monitors at a central place the data exchange between two networks. Mostly the Firewall monitors the data exchange between an internal, local network (LAN), and an external network like the Internet.

The Firewall can consist of hard and/or software components:

- In pure hardware systems the Firewall software often runs on a proprietary operating system.
- The Firewall software can also run on a conventional workstation, which is dedicated to this task under Linux, Unix or Windows.
- As a third and frequently used alternative, the Firewall software runs directly within the router, which connects the LAN to the Internet.

In the following sections we only look at the Firewall in a router.

---

 The functions "Intrusion Detection" and "DoS protection" are part of the content of a Firewall in some applications. The LANCOM contains these functions also, but they are realised as separate modules beside the Firewall. Further information can be found in the section and .

## 8.2.1 Tasks of a Firewall

### Checking data packets

How does the Firewall supervises the data traffic? The Firewall works in principle like a door keeper for data packets: Each packet will be checked, whether it may pass the door of the network (Firewall) in the desired direction or not. For such a checking different criteria are used, in common language of Firewalls called "rules" or "guidelines". Depending on the kind of information, which are used for creation of the rules and which are checked during the operation of the Firewall, one distinguishes different types of Firewalls.

Above all, the aspect of the "central" positioning is very Important: Only when the entire data traffic between "inside" and "outside" goes through the Firewall, it can fulfil its task reliably under any circumstances. Each alternative way can reduce or even turn off the security of the Firewall. This central position of the Firewall simplifies by the way also the maintenance: One Firewall as common passage between two networks is certainly easier to maintain than a "Personal Firewall" on each of the workstations belonging to the LAN.

---

 In principle, Firewalls operate at the interconnection between two or more networks. For the following explanation, we only look as example at the passage between a local network of a company and the Internet. These explanations can be transferred however in a general manner also to other network constellations, e.g. for the protection of a subnetwork of the personnel department of a company against the remaining network users.

### Logging and alerting

An important function of the Firewall is beside the checking of data packets and the right reaction to the results of this checking also the logging of all actions triggered by the Firewall. By analyzing these protocols, the administrator can draw conclusions from the occurred attacks and on the basis of this information he can, if necessary, go on to improve the configuration of the Firewall.

But sometimes, logging alone comes too late. Often, an immediate intervention of the administrator can prevent a major danger. That is why Firewalls have mostly an alerting function, by which the Firewall notifies the administrator e.g. by e-mail.

## 8.2.2 Different types of Firewalls

During the last years, the operating principles of Firewalls have more and more evolved. Under the generic term "Firewall", a whole range of different technical concepts is offered to protect the LAN. Here we introduce the most important ones.

## Packet filters

One speaks about a packet filter-based Firewall, if the router only checks the details in the header of the data packets and decides on the basis of this information, whether the packet may pass or not. The following details belong to the analyzed information:

- IP address of source and destination
- Transfer protocol (TCP, UDP or ICMP)
- Port numbers of source and destination
- MAC address

The rules defined in a packet filter-orientated Firewall determine e.g., whether the packets may pass on by a special IP address range into the local network, or whether packets should be filtered for special services (i.e. with special port numbers). By these measures, the communication with certain workstations, entire networks or via special services can be reduced or even prevented. Besides, the rules are combinable, so that e.g. only workstations with special IP addresses get access to the Internet via the TCP port 80, while this services remains blocked for all other workstations.

The configuration of packet filtering Firewalls is quite simple, and the list with the permitted or forbidden packets can be extended very easily. Because also the performance requirements of a packet filter can be address with quite little means, the packet filters are often directly implemented in routers, which operate as interface between the networks anyway.

An unfavorable effect on the packet filters is, that the list of rules becomes uncomfortable after a while. Besides, for some services the connection ports are negotiated dynamically. To enable communication then, the administrator has to leave open all possibly used ports, which is contrary to the basic orientation of most security concepts.

One example for a process, which is quite problematical for simple packet filters, is the establishing of a FTP connection from a workstation of the own LAN to a FTP server in the Internet. By the generally used active FTP, the client (of the protected LAN) sends an inquiry from a port of the upper range (>1023) to port 21 of the server. The client informs the server, over which port it is expecting the connection. The server will establish as a result from its port 20 a connection to the desired port of the client.

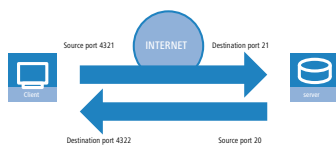

To enable this process, the administrator of the packet filter must open all ports for incoming connections, because he does not know in advance for which port the client will inquire the FTP connection. An alternative is to use passive FTP. Thereby, the client establishes the connection itself to the server over a particular port, which was told to the server before. This process is, however, not supported by all clients/servers.

If we furthermore compare the Firewall with a porter, this door keeper only checks, whether he knows or not the courier with the packet at the door. If the courier is known and came ever into the building before, he has the permission to go in without hindrance and without being checked also for all following orders up to the workplace of the addressee.

## Stateful Packet Inspection

Stateful Packet Inspection (SPI), or briefly Stateful Inspection, enhances the packet filter approach by checking further connection state information. Beside the more static table with the permitted ports and address ranges, a dynamic table will be kept up in this variant, in which information about the connection state of the individual connections is held. This dynamic table enables to first block all endangered ports, and to selectively open only if required a port for a permitted connection (adjusted by source and destination address). The opening of ports is always made from the protected network to the unprotected one, that means mostly from LAN to WAN (Internet). Data packets that do not belong to one of the tracked session of the connection state table will be automatically discarded

## Stateful Inspection: direction-dependent checking

The filter sets of a Stateful Inspection Firewall are - contrary to classical port filter Firewalls - dependent on their direction. Connections can only be established from source to their destination point. The other direction would require an explicit filter entry as well. Once a connection has been established, only the data packets belonging to this connection will be transmitted - in both directions, of course. So you can block in a reliable way all traffic not belonging to a known session, not coming from the local network.

Additionally, the Stateful Inspection is able to track from the connection set up, whether additional channels are negotiated for data exchange or not. Some protocols like e.g. FTP (for data transfer), T.120, H.225, H.245 and H.323 (for netmeeting or IP telephony), PPTP (for VPN tunnels) or IRC (for chatting) signalize when establishing the connection from the LAN to the Internet by a particular used source port whether they are negotiating further ports with the remote station. The Stateful Inspection dynamically adds also these additional ports into the connection state list, of course limited to the particular source and destination addresses only.

Let's have once again a look at the FTP download example. When starting the FTP session, the client establishes a connection from source port '4321' to the destination port '21' of the server. The Stateful Inspection allows this first set up, as long as FTP is allowed from local workstations to the outside. In the dynamic connection state table, the Firewall enters source and destination and the respective port. Simultaneously, the Stateful Inspection can inspect the control information, sent to port 21 of the server. These control signals indicate that the client requires a connection of the server from its port 20 to port 4322 of the client. The Firewall also enters these values into the dynamic table, because the connection to the LAN has been initiated from the client. Afterwards, the server can send so the desired data to the client.

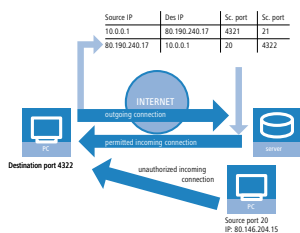

But if another workstation from the Internet tries to use the just opened port 4322 of the LAN to file itself data from its port 20 on the protected client, the Firewall will stop this try, because the IP address of the attacker does not fit to the permitted connection!

⚠ After the successful data transfer, the entries disappear automatically from the dynamic table and the ports will be closed again.

Moreover, a Firewall with Stateful Inspection is mostly able to re-assemble the received data packets, that means to buffer the individual parts and to assemble them again to an complete packet. Therefore, complete IP packets can be checked by the Firewall, rather than individual parts only.

This porter is making a definite better job. When somebody in this company orders a courier, he must also inform the porter that he is expecting a courier, when he will be arriving and what information should be found on the delivery note. Only when this information matches the logbook entries of the porter, the courier may pass. If the courier brings not only one packet, but rather two, only the one with the correct delivery note will pass. Likewise, a second courier demanding access to the employee will be rejected, too.

## Application Gateway

By checking of contents on application level, Application Gateways increase the address checking of the packet filters and the connection monitoring of the Stateful Packet Inspection. The Application Gateway runs mostly on a separate workstation, because of the high demands to the hardware performance. This workstation is between the local network

and the Internet. Seen from both directions, this workstation is the only possibility to exchange data with the respective other network. There doesn't exist any direct connection between these two networks, but just to the Application Gateway.



The Application Gateway is thus a kind of proxy for each of the two networks. Another term for this constellation is the "dualhomed gateway", because this workstation is so to speak at home in two networks.

For each application to be allowed through this gateway, an own service will be set up, e.g. SMTP for mail, HTTP for surfing the Internet or FTP for data downloads.

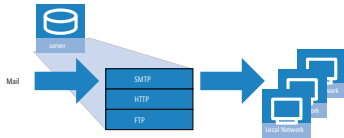

This service accepts data received by either one of the two sides and depicts it to the respective other side. What seems to be at first sight a needless mirroring of existing data, is on closer examination the far-reaching concept of Application Gateways: It never exists a direct connection e.g. between a client of the local network and a server of the Internet. The LAN workstations only see the proxy, the workstations of the Internet likewise. This physical separation of LAN and WAN, makes it quite difficult for attackers to intrude into the protected network.

Applied to the porter example, the packet will be left at the gate, the courier is not allowed to enter the company premises. The porter takes the packet, will open it after checking address and delivery note and will control also the content. When the packet has taken these hurdles successfully, then the company internal courier will bring it himself to the addressee of the company. He became proxy of the courier on company premises. The other way around, all employees, wanting to send a packet, have to inform the porter, which has to collect the packet at the workstation place and which will hand over the packet to the ordered courier at the gate.

! Functions of Application Gateways are not supported by the LANCOM, mainly because of the high hardware demands.

## 8.3 The LANCOM Firewall

After general explanations concerning the dangers of the Internet and the tasks and types of Firewalls, this chapter describes special functions of the LANCOM Firewall and concrete configurations.

For LANCOM devices with VoIP functions that were already integrated or added in with a software option, the ports required for voice connections are activated automatically.

### 8.3.1 How the LANCOM Firewall inspects data packets

The Firewall filters only those data packets out of the entire data stream running through the IP router of the LANCOM, for which a special treatment has been defined.

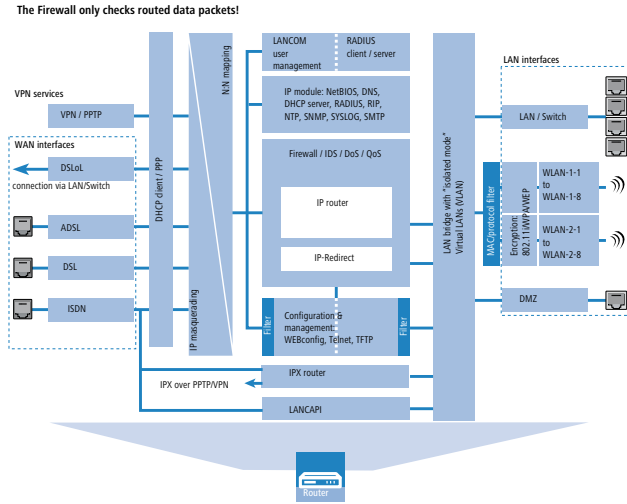

The Firewall only checks data packets routed by the IP router of the LANCOM. In general, these are the data packets, which are exchanged between one of the WAN interfaces and the internal networks (LAN, WLAN, DMZ).

For example, the communication between LAN and WLAN is normally not carried out by the router, as long as the LAN bridge allows a direct exchange. Thus the Firewall rules do not apply here. The same applies to the so-called "internal services" of the LANCOM like Telnet, TFTP, SNMP and the web server for the configuration with WEBconfig. The data packets of these services do not run through the router, and therefore aren't influenced by the Firewall.

**!** Due to the positioning behind the masquerading module (seen from the WAN), the Firewall operates with the "real" internal IP addresses of the LAN stations, and not with the outside known Internet address of the LANCOM.

The LANCOM Firewall uses several lists for checking data packets, which are automatically generated from Firewall rules, resulting Firewall actions or by active data connections:

- Host block list
- Port block list
- Connection list
- Filter list

When a data packet should be routed via the IP router, the Firewall uses the lists as follows:

1. The first check is, whether the packet was coming from a workstation belonging to the host block list. If the sender is blocked, the packet will be discarded.
2. If the sender is not blocked in this list, the port block list will be checked, if the used port/protocol combination on the destination PC is closed. In this case the packet will be discarded.
3. If sender and destination are not blocked in the first two lists, then it will be checked whether a connection entry exists for this packet in the connection list. If such an entry exists, then the packet will be handled as noted in this list.



- If no entry has been found for the packet, then the filter list will be searched, whether a suitable entry exists and the action indicated in this list will be carried out. If the action intends to accept the packet, then an entry is made in the connection list, as well as for any further actions.

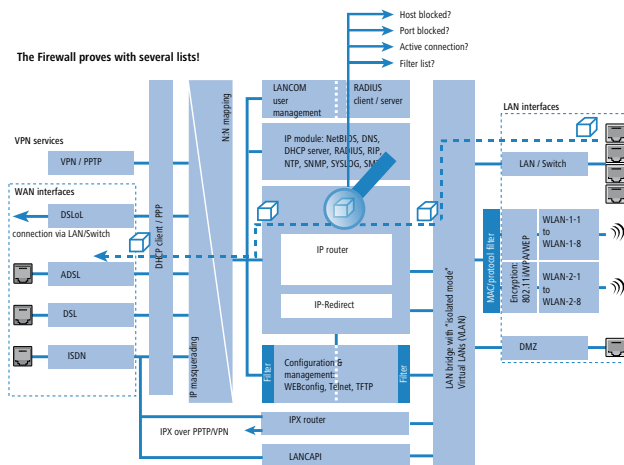

! If no explicit Firewall rule exists for a data packet, the packet will be accepted ('Allow-All'). That grants a backward-compatibility for existing installations. For maximum protection by the Stateful Inspection, please note the section .

The four lists obtain their information as follows:

- In the host block list are all those stations listed, which are blocked for a certain time because of a Firewall action. The list is dynamic, new entries can be added continuously with appropriate actions of the Firewall. Entries automatically disappear after exceeding the timeout.
- In the **port block list** those protocols and services are filed, which are blocked for a certain time because of a Firewall action. This list is likewise a dynamic one, new entries can be added continuously with the appropriate Firewall actions. Entries automatically disappear after exceeding the timeout.
- For each established connection an entry is made in the connection list, if the checked packet has been accepted by the filter list. In the connection list is noted from which source to which destination, over which protocol and which port a connection is actually allowed. The list contains in addition, how long an entry will stay in the list and which Firewall rule is responsible for the entry. This list is very dynamic and permanently "moving".
- The filter list is made of the Firewall rules. The containing filters are static and only changed when Firewall rules are added, edited or deleted.

Thus all lists, which are consulted by the Firewall to check data packets, finally base on the Firewall rules.

### 8.3.2 Special protocols

One important point during the connection tracking is the treatment of protocols that dynamically negotiate ports and/or addresses, over which further communication is done. Examples of these kinds of protocols are FTP, H.323 or also many UDP-based protocols. Thereby it is necessary that further connections must be opened, additionally to the first connection. See also .

#### UDP connections

UDP is actually a stateless protocol, nevertheless one can speak regarding UDP-based protocols also of a (only short term) connection, since UDP mostly carries Request/Response based protocols, with which a client directs its requests to a well known port of a server (e.g. 53 for DNS), which in turn sends its responds to the source port selected by the client

:

Client port	Connection	Server port
12345	Request →	53
12345	Response ←	53

However, if the server wants to send larger sets of data (e.g. TFTP) and would not like or can not differentiate on the well known port between requests and acknowledges, then it sends the response packets to the source port of the sender of the original request, but uses as its own source port a free port, on which it reacts now only to those packets, which belong to the data communication:

Client port	Connection	Server port
12345	Request →	69
12345	Response ←	54321
12345	Ack/Data →	54321
12345	Data/Ack ←	54321

While the data communication takes place now over the ports 12345 and 54321, the server on the well-known port (69) can accept further requests. If the LANCOM pursues a "Deny All" strategy, the answer packets of an entry of the port filter Firewall, which permits only a connection to port 69 of the server, would simply be discarded. In order to prevent this, when creating the entry in the connection state database, the destination port of the connection is kept free at first, and set only with the arrival of the first answer packet, whereby both possible cases of an UDP connection are covered.

### TCP connections

TCP connections cannot be tracked only by examination of the ports. With some protocols (e.g. FTP, PPTP or H.323) examinations of the utilizable data are necessary to open all later negotiated connections, and to accept only those packets belonging really to the connections. This corresponds to a simplified version of IP masquerading, but without addresses or ports to be re-mapped here. It is sufficient to pursue the negotiation to open appropriate ports, and link them with the main connection, so that these ports are closed likewise with the closing of the main connection, and traffic on the secondary connection keeping open also the main connection.

### ICMP connections

For ICMP two cases must be differentiated: The ICMP request/reply connections, like to be used with "ping", and the ICMP error messages, which can be received as an answer to any IP packet.

ICMP request/reply connections can be clearly assigned to the identifier used by the initiator, i.e. in the status database an entry will be provided with the sending of an ICMP request, which lets through only ICMP replies with the correct identifier. All other ICMP replies will get discarded silently.

In ICMP error messages, the IP header and the first 8 bytes of the IP packet (on behalf UDP or TCP headers) can be found within the ICMP packet. With the help of this information, the receipt of an ICMP error message triggers automatically the search for the accessory entry in the status database. The packet passes only if such an entry exists, otherwise it is discarded silently. Additionally, potentially dangerous ICMP error messages (redirect route) are filtered out.

## Connections of other protocols

For all other protocols no related connections can be followed up, i.e. with them only a connection between involved hosts can occur in the status database. These can be initiated also only from one side, unless, in the port filter Firewall exists a dedicated entry for the "opposite direction".

### 8.3.3 General settings of the Firewall

Apart from individual Firewall rules, which ensure the entries in the filter, connection and block lists, some settings apply generally to the Firewall:

- Firewall/QoS enabled
- Administrator email
- Fragments
- Re-establishing of the session
- Ping blocking
- Stealth mode
- Mask authentication port

#### Firewall/QoS enabled

This option switches on or off the entire Firewall, including Quality of Service functions.

 Please notice that the N:N mapping functions are only active when the Firewall has been switched on!

#### Administrator email

One of the actions a Firewall can trigger is alerting of a network administrator via email. The "administrator email" is the email account, to which the alerting mails are sent to.

#### Fragments

Some attacks from the Internet try to outsmart the Firewall by fragmented packets (packets split into several small units). One of the main features of a Stateful Inspection like in the LANCOM is the ability to re-assemble fragmented packets in order to check afterwards the entire IP packet.

You can centrally adjust the desired behavior of the Firewall. The following options are available:

- **Filter:** Fragmented packets are directly discarded by the Firewall.
- **Route:** Fragmented packets are passed on without any further checking by the Firewall, as long as permitted by valid filter settings.
- **Re-assemble:** Fragmented packets are buffered and re-assembled to complete IP packets. The re-assembled packets will then be checked and treated according to the valid filter settings.

#### Session recovery

The Firewall enters all actual permitted connections into the connection list. Entries disappear automatically from the connection list after a certain time (timeout), when no data has been transmitted over this connection any more re-triggering the timeout.

Sometimes connections are ended according to the general TCP aging settings, before data packets requested by an inquiry have been received by the remote station. In this case perhaps an entry for a permitted connection still exists in the connection list, but the connection itself is no more existing.

The parameter "Session recovery" determines the behavior of the Firewall for packets that indicate a former connection:

- **Always denied:** The Firewall re-establishes the session under no circumstances and discards the packet.
- **Denied for default route:** The Firewall re-establishes the session only if the packet wasn't received via the default route (e.g. Internet).

- **Denied for WAN:** The Firewall re-establishes the session only if the packet wasn't received over one of the WAN interfaces.
- **Always allowed:** The Firewall re-establishes the connection in principle if the packet belongs to a former connection of the connection list.

---

ⓘ The function of the virtual routers is based on the analysis of the interface-tag, that is why in addition to the untagged default routes, as well other routes are included as default routes:

- When a packet is received at a **WAN interface**, then the WAN interface is considered by the firewall to be a default route if either a tagged or an untagged default route refers to this WAN interface.
  - If a packet is received at a **LAN interface** and is to be routed to a WAN interface, then this WAN interface is considered to be a default route if either the untagged default route or if a default route tagged with the interface tag refers to this WAN interface.

Default route filter are as well effective if the default route is in the LAN. Here it applies that the filter takes effect when:

- A packet was received over a tagged LAN interface and is to be sent over a default route tagged with the interface, or
  - A packet from another router was received at a tagged LAN interface and there is a default route with the interface tag to the packet's source address, or
  - A packet was received from the WAN and is to be sent to the LAN via a default route with any tag

## Ping blocking

One - not undisputed - method to increase security is hiding the router. Based loosely on the method: "Who doesn't see me neither tries to attack me...". Many attacks begin with the searching for workstations and/or open ports by actual harmless inquiries, e. g. with the help of the "ping" command or with a portscan. Each answer to these inquiries, even the answer "I'm not here" indicates to the attacker that he has found a potential destination. Because anybody who answers must be existing, too. In order to prevent this conclusion, the LANCOM is able to suppress the answers to these inquiries.

In order to achieve this, the LANCOM can be instructed not to answer ICMP echo requests any more. At the same time TTL-exceeded messages of a "trace route" are also suppressed, so that the LANCOM cannot be found, neither by "ping" nor by "trace route".

Possible settings are:

- **Off:** ICMP answers are not blocked.
- **Always:** ICMP answers are always blocked.
- **WAN only:** ICMP answers are blocked on all WAN connections.
- **Default route only:** ICMP answers are blocked on default route (usually Internet).

---

ⓘ The hints for the chapter Session recovery consider as well the choice of the default routes.

## TCP Stealth mode

Apart from ICMP messages, also the behavior in case of TCP and UDP connections gives information on the existence or non-existence of the addressed workstation. Depending on the surrounding network it can be useful to simply reject TCP and UDP packets instead of answering with a TCP RESET resp. an ICMP message (port unreachable), if no listener for the respective port exists. The desired behavior can be adjusted in the LANCOM.

---

ⓘ If ports without listener are hidden, this generates a problem on masked connections, since the "authenticate" - resp. "ident" service does no longer function properly (resp. do no longer correctly reject). The appropriate port can so be treated separately.

Possible settings are:

- **Off:** All ports are closed and TCP packets are answered with a TCP reset.
- **Always:** All ports are hidden and TCP packets are silently discarded.
- **WAN only:** On the WAN side all ports are hidden and on the LAN side closed.
- **Default route only:** Ports are hidden on the default route (usually Internet) and closed on all other routes.

### Mask authentication port

When TCP or UDP ports are hidden, inquiries of mail servers to authenticate users can no more be answered correctly. Inquiries of the servers run into a timeout, and delivery of mails will be considerably delayed.

Also when the TCP Stealth mode is activated, the Firewall detects the intention of a station in the LAN to establish a connection to a mail server. As a result, the needed port will be opened for a short time (20 seconds) solely for the authentication inquiry.

This behavior of the Firewall in TCP Stealth mode can be suppressed specifically with the parameter "Always mask authentication port, too".

---

 The activation of the option "Mask authentication port" can lead to considerable delays for the dispatch and receipt of e. g. emails or news!

A mail or a news server, which requests any additional information from the user with the help of this service, runs first into a disturbing timeout, before it begins to deliver the mails. This service needs thus its own switch to hide and/or to hold it "conformingly".

The problem thereby is however that a setting, which hides all ports, but rejects the ident port is unreasonable - alone by the fact that rejecting the ident port would make the LANCOM visible.

The LANCOM offers now the possibility to reject ident inquiries only by mail and news servers, and to discard those of all other PCs. For this, the ident inquiries of the respective servers are rejected for a short time (20 seconds) when a mail (SMTP, POP3 IMAP2) or a news server (NNTP) is calling up.

When the timeout is exceeded, the port will be hidden again.

## 8.3.4 Parameters of Firewall rules

In this section we describe the components of Firewall rules and the available options to set up the different parameters.

---

 Information regarding definition of Firewall rules with the different kinds of configuration tools (LANconfig, WEBconfig or Telnet) can be found in chapter and .

### Components of a Firewall rule

A Firewall rule is at first defined by its name and some further options:

- **On/Off switch:** Is the rule active for the Firewall?
- **Priority:** Which is the priority of the rule?
- **Observe further rules:** Should further Firewall rules be observed when this rule applies to a data packet?
- **Create VPN rule:** Is this Firewall rule also used to create a VPN rule?
- **Routing Tag:** When applying the routing tag further information about for instance the used service or protocol can be used for selecting the target route. With this so called policy based routing a much better control of the routing behaviour is possible.

### Priority

When setting up the filter list of the Firewall rules, the LANCOM will automatically sort the entries. Thereby the "grade of detail" will be considered: All specified rules are observed at first, after that the general ones (e. g. Deny All).

If after the automatic sorting the desired behavior of the Firewall does not turn out, it is possible to change the priority manually. The higher the priority of the Firewall rule, the earlier it will be placed in the according filter list.

---

 For complex rule types please check the filter list as described in section .

### Observe further rules

There are requirements to a Firewall, which cannot be covered by a single rule. If the Firewall is used to limit the Internet traffic of different departments (in own IP subnetworks), individual rules cannot e.g. illustrate the common upper limit at the same time. If to everyone of e.g. three departments should be granted a bandwidth of maximal 512 kbps, but the entire data rate of the three departments should not exceed a limit of 1024 kbps, then a multi-level checking of the data packets must be installed:

- In a first step it will be checked, if the actual data rate of the individual department does not exceed the limit of 512 kbps.
- In a second step it will be checked, if the data rate of all departments together does not exceed the overall limit of 1024 kbps.

Normally the list of the Firewall rules is applied sequentially to a received data packet. If a rule applies, the appropriate action will be carried out. The checking by the Firewall is terminated then, and no further rules will be applied to the packet.

In order to reach a two-stage or multi-level checking of a data packet, the "Observe further rules option" will be activated for the rules. If a Firewall rule with activated observation of further rules applies to a data packet, the appropriate action will be carried out at first, but then the checking in the Firewall will continue. If one of the further rules applies also to this data packet, the action being defined in this rule will also be carried out. If also for this following rule the observe further rules option is activated, the checking will be continued until

- either a rule applies to the packet, for which observe further rules is not activated.
- or the list of the Firewall rules has been completely worked through without applying a further rule to the packet.

To realize this aforementioned scenario it is necessary to install for each subnetwork a Firewall rule that rejects from a data rate of 512 kbps up additional packets of the protocols FTP and HTTP. For these rules the observe further rules option will be activated. Defined in an additional rule for all stations of the LAN, all packets will be rejected which exceed the 1024 kbps limit.

### VPN rules

A VPN rule can receive its information about source and destination network from Firewall rules.

By activating the option "This rule is used to create VPN rules" for a Firewall rule, you determine that a VPN rule will be derived from this Firewall rule.

If more than one local network is used (see ARF), the automatic extraction of the VPN rules has to be set up individually for every network. The definition of networks with automatically generated VPN rules uses the interface tag which is given for every network. This tag enables the allocation of local network to VPN route: Every packet received at a local interface is marked with the interface tag and forwarded along a route with the same tag or with the default tag (0).

For automatic VPN rule generation, all networks are taken up that

- Have the tag '0' or
- Fulfill the two conditions as follow:
  - The network has the same interface tag as the IP-routing-table entry for the VPN connection (not to be confused with the routing tag for the remote gateway).
  - The network is of the type 'Intranet'.

---

 VPN rules for a DMZ also have to be manually created just as for networks with an interface tag which does not fit to the routing tag of the VPN route.

## Application of the firewall rules

Apart from this basic information, a Firewall rule answers the question when and/or on what it should apply to and which actions should be executed:

- **Stations / Service:** To which stations/networks and services/protocols does the rule refer to?
- **Conditions:** Is the effectiveness of the rule reduced by other conditions?
- **Trigger:** On exceeding of which threshold shall the rule being triggered?
- **Action:** What should happen to the data packets when the condition applies and the limit is reached?
- **Further measures:** Should further measures be initiated apart from the packet action?
- **Quality of Service (QoS):** Are data packets of certain applications or with the corresponding markings transferred preferentially by assurance of special Quality of Services?

! Condition, limit, packet action and other measures form together a so-called “action set”. Each Firewall rule can contain a number of action sets. If the same trigger is used for several action sets, the sequence of action sets can be adjusted.

In section we have already described that in the end the lists for checking data packets are created from Firewall rules. Thus the extension of the block diagram looks like as follows:

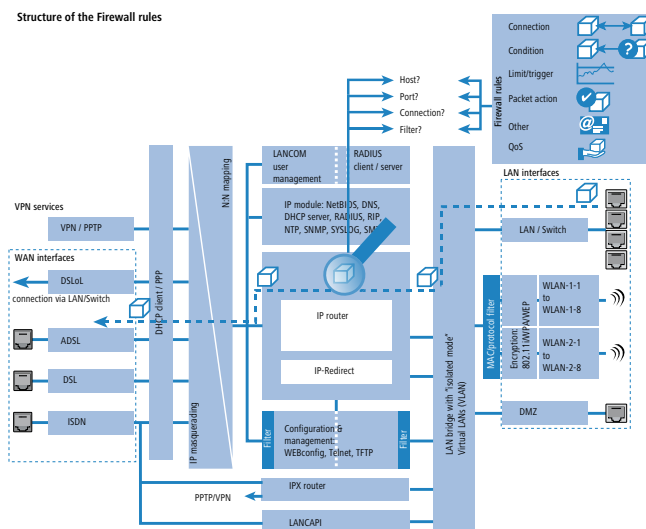

## Connection



The connection of a Firewall rule defines to which data packets the rule should refer to. A connection is defined by its source, its destination and the used services. The following details can be used to specify the source or destination:

- All stations
- The entire local network (LAN)
- Certain remote stations (described by the name of the remote site list)
- Certain stations of the LAN described by the host name)
- Certain MAC<sup>1</sup> addresses
- Ranges of IP addresses

<sup>1</sup> MAC is the abbreviation for Media Access Control and it is the crucial factor for communication inside of a LAN. Every network device has its own MAC address. MAC addresses are worldwide unique, similar to serial numbers. MAC addresses allow distinguishing between the PCs in order to give or withdraw them dedicated rights on an IP level. MAC addresses can be found on most networking devices in a hexadecimal form (e.g. 00:A0:57:01:02:03).

- Complete IP networks

You can only operate with host names, when your LANCOM is able to transform the names into IP addresses. For that purpose the LANCOM must have learned the names via DHCP or NetBIOS, or the assignment must be entered statically in the DNS or IP routing table. An entry in the IP routing table can therefore assign a name to a whole network.

 If the source or the destination for a Firewall rule has not been determined at greater detail, the rule applies generally to data packets "from all stations" resp. "to all stations".

The service is determined by the combination of an IP protocol with respective source and/or destination port. For frequently used services (www, mail, etc.) the appropriate combinations are already predefined in the LANCOM, others can be compiled additionally as required.

## Condition



The effectiveness of a Firewall rule is also reduced with additional conditions. The following conditions are available:

- Only packets with certain ToS and/or DiffServ markings.
- Only, if the connection does not yet exist.
- Only for default route (Internet).
- Only for VPN routes.

## Limit / Trigger



The limit or trigger describes a quantified threshold value that must be exceeded on the defined connection before the filter action gets executed for a data packet. A limit is composed by the following parameters:

- Unit (kbit, kbyte or packets)
- Amount, that means data rate or number.
- Reference value (per second, per minute, per hour or absolute)

Additionally, you can adjust for the limit whether it refers to a logical connection or to all connections together, which exist between the defined destination and source stations via the corresponding services. Thus it is controlled whether the filter takes effect, if e.g. all HTTP connections of the users in the LAN exceed the limit in sum, or whether it is sufficient that only one of the parallel established HTTP connections exceeds the threshold value.

For absolute values it is additionally possible to specify whether the counter belonging to it will be reset to zero when the limit has been reached.

 In any case, data will be transferred if a limit has not been reached yet! With a trigger value of zero a rule becomes immediately active, as soon as data packets arrive for transmission on the specified connection.

## Packet action



The Firewall has three possibilities to treat a filtered packet:

- **Transmit:** The packet will be transferred normally.
- **Drop:** The packet will be discarded silently.
- **Reject:** The packet will be rejected, the addressee receives an appropriate message via ICMP.



## Further measures



The Firewall does not only serve to discard or accept the filtered data packets, but it can also take additional measures when a data packet has been registered by the filter. The measures here are divided into the fields "protocolling/notification" and "prevent further attacks":

- **Send a Syslog message:** Sends a message via the SYSLOG module to a SYSLOG client, as defined in configuration field "Log & Trace".
- **Send an email message:** Sends an email message to the administrator, using the account specified in the configuration field "Log & Trace".
- **SNMP/LANmonitor:** Sends a SNMP trap, that will be analyzed e. g. by LANmonitor.



Each of these three message measures leads automatically to an entry in the Firewall event table.

- **Disconnect:** Cuts the connection, over which the filtered packet has been received.



On the occasion, the physical connection will be cut off (e. g. the Internet connection), not only the logical connection between the two involved PCs!

- **Lock source address:** Blocks the IP address from that the filtered packet has been received for a given time.
- **Lock target port:** Blocks the destination port to that the filtered packet has been sent for a given time.

## Quality of Service (QoS)



Apart from the restrictions for the transfer of data packets, the Firewall can also concede a "special treatment" to certain applications. QoS settings use features of the Firewall to specifically identify data packets of certain connections or services.



For further information about QoS and the appropriate configuration please see chapter .

### 8.3.5 Alerting functions of the Firewall

This paragraph describes the Firewall alerts in detail that are sent on security-relevant events. The following message types are available:

- Email notification
- SYSLOG report
- SNMP trap

Alerts are triggered either separately by the intrusion detection system, by the denial of service protection or by arbitrary trigger conditions specified in the Firewall. The specific parameters for the different alerting types such as the relevant email account can be set at the following places:

LANconfig: Log & TraceE/ SMTP Account E/ SNMP E/ SYSLOG

WEBconfig: LCOS menu tree E/ Setup / SMTP E/ SNMP Module / SYSLOG Module

An example:

Let us assume a filter named 'BLOCKHTTP', which blocks all access to a HTTP server 192.168.200.10. In case some station would try to access the server nevertheless, the filter would block any traffic from and to this station, and inform the administrator via SYSLOG also.

#### SYSLOG notifications

If the Firewall drops an appropriate packet, a SYSLOG notification is created as follows:

```
PACKET_ALERT: Dst: 192.168.200.10:80 {}, Src: 10.0.0.37:4353 {} (TCP):
port filter
```

Ports are printed only for port-based protocols. Station names are printed, if the LANCOM can resolve them directly (without external DNS request).

If the SYSLOG flag is set for a filter entry (%s action), then this notification becomes more detailed. Then the filter name, the exceeded limit and the filter action carried out are printed also. For the example above this should read as:

```
PACKET_ALERT: Dst: 192.168.200.10:80 {}, Src: 10.0.0.37:4353 {} (TCP):
port filter
```

```
PACKET_INFO:
```

```
matched filter: BLOCKHTTP exceeded limit: more than 0 packets transmitted
or received on a connection actions: drop; block source address for 1
minutes; send syslog message;
```

### Notification by email

If the email system of the LANCOM is activated, then you can use the comfortable notification by email. The device sends an email to the administrator as soon as the firewall executes the appropriate action:

```
FROM: LANCOM_Firewall@MyCompany.com TO: Administrator@MyCompany.com
SUBJECT: packet filtered
```

```
Date: 9/24/2002 15:06:46
```

The packet below

```
Src: 10.0.0.37:4353 {cs2} Dst: 192.168.200.10:80 {ntserver} (TCP)
45 00 00 2c ed 50 40 00 80 06 7a a3 0a 00 00 25 | E...P@. ..z....% c0
a8 c8 0a 11 01 00 50 00 77 5e d4 00 00 00 00 |P .w^..... 60 02
20 00 74 b2 00 00 02 04 05 b4 | ` .t... ..
```

```
matched this filter rule: BLOCKHTTP and exceeded this limit: more than
0 packets transmitted or received on a connection
```

```
because of this the actions below were performed: drop block source
address for 1 minutes send syslog message send SNMP trap send email to
administrator
```

Sending the email from the LANCOM to the administrator only works if the right email address is entered.

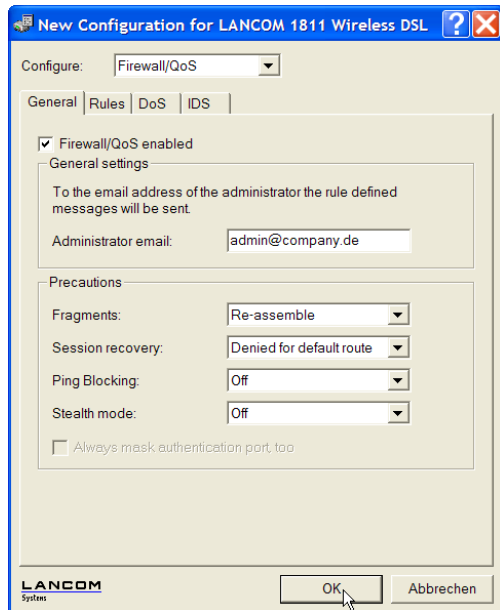

LANconfig: Firewall/QoS / General

WEBconfig: LCOS menu tree / Setup / IP Router / Firewall

For sending an email there needs to be set up an email account.

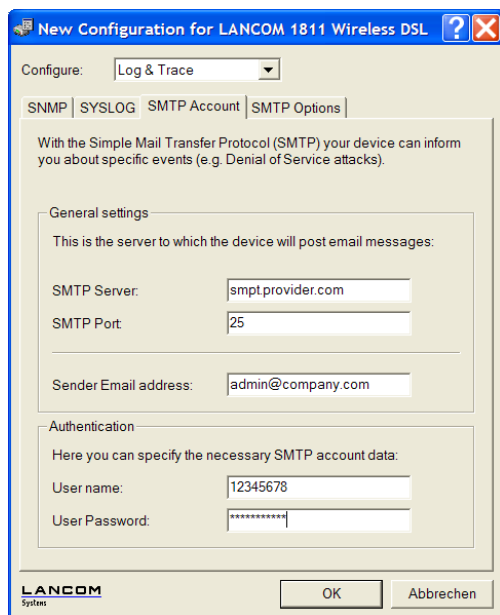

LANconfig: Log & Trace E SMTP Account

WEBconfig: LCOS menu tree / Setup / SMTP

## Notification by SNMP trap

If as notification method dispatching SNMP traps was activated (see also ), then the first line of the logging table is sent away as enterprise specific trap 26. This trap contains additionally the system descriptor and the system name from the MIB-2.

For the example the following trap is thus produced:

```
SNMP: SNMPv1; community = public; SNMPv1 Trap; Length = 443 (0x1BB)
SNMP: Message type = SNMPv1
SNMP: Version = 1 (0x0)
SNMP: Community = public
SNMP: PDU type = SNMPv1 Trap
SNMP: Enterprise = 1.3.6.1.4.1.2356.400.1.6021
SNMP: Agent IP address = 10.0.0.43
SNMP: Generic trap = enterpriseSpecific (6)
SNMP: Specific trap = 26 (0x1A)
SNMP: Time stamp = 1442 (0x5A2)
SNMP: OID = 1.3.6.1.2.1.1.1.0 1.
```

---

 System descriptor

```
SNMP: String Value = LANCOM Business 6021 2.80.0001 / 23.09.2002
8699.000.036
SNMP: OID = 1.3.6.1.2.1.1.5.0 2. System-Name
```

---

 Device string

```
SNMP: String Value = LANCOM Business 6021
SNMP: OID = 1.3.6.1.4.1.2356.400.1.6021.1.10.26.1.2.1 3.
```

---

 Time stamp

```
SNMP: String Value = 9/23/2002 17:56:57
SNMP: OID = 1.3.6.1.4.1.2356.400.1.6021.1.10.26.1.3.1 3.
```

---

 Source address

```
SNMP: IP Address = 10.0.0.37
SNMP: OID = 1.3.6.1.4.1.2356.400.1.6021.1.10.26.1.4.1 4.
```

---

 Destination address

```
SNMP: IP Address = 192.168.200.10
SNMP: OID = 1.3.6.1.4.1.2356.400.1.6021.1.10.26.1.5.1 5.
```

---

 Protocol (6 = TCP)

```
SNMP: Integer Value = 6 (0x6) TCP
SNMP: OID = 1.3.6.1.4.1.2356.400.1.6021.1.10.26.1.6.1 6.
```

---

 Source port

SNMP: Integer Value = 4353 (0x1101)

SNMP: OID = 1.3.6.1.4.1.2356.400.1.6021.1.10.26.1.7.1 7.

---

! Destination port (80 = HTTP)

SNMP: Integer Value = 80 (0x50)

SNMP: OID = 1.3.6.1.4.1.2356.400.1.6021.1.10.26.1.8.1 8.

---

! Name of the filter rule

SNMP: String Value = BLOCKHTTP

---

! This trap and all different in the LANCOM generated traps are sent to all manually configured trap receivers, just like to each registered LANmonitor, which can evaluate this and possibly all other traps.

### 8.3.6 Strategies for Firewall settings

Firewalls are the interface between networks, and they restrict to a smaller or larger extent an unhindered data exchange. Thus Firewalls have opposite objectives than networks, although they are a part of them: networks should connect workstations, Firewalls should prevent the connection.

This contradiction shows the dilemma of the responsible administrators who have developed subsequently different strategies to solve this problem.

#### Allow All

The Allow All strategy favours unhindered communication of the employees compared over security. Any communication is allowed at first, the LAN is still open for attackers. The LAN becomes gradually more secured by configuration of the administrator, by settings of more and more new rules, which restrict or prevent parts of communication.

#### Deny All

The Deny All strategy proceeds at first according to the method "Block all!". The Firewall blocks completely the communication between the protected network and the rest of the world. In a second step, the administrator opens address ranges or ports, which are necessary e.g. for daily communication with the Internet.

This approach ensures superior security for the LAN security compared to the Allow All strategy, but may lead especially in its initial stages to difficulties for the users. After activation of the Deny All strategy, some things just may behave differently than before, some stations may not reached any more etc.

#### Firewall with DMZ

The demilitarized zone (DMZ) is a special range of the local network, which is shielded by a Firewall both against the Internet and against the normal LAN. All stations or servers that should be accessible from the unsecured network (Internet) should be placed into this network. These include for example own FTP and web servers.

The Firewall protects at first the DMZ against attacks from the Internet. Additionally, the Firewall protects also the LAN against the DMZ. To do so, the Firewall is configured in this way that only the following accesses are possible:

- Stations from the Internet can access to the servers in the DMZ, but no access from the Internet to the LAN is possible.
- The stations of the LAN can access the Internet, as well as servers in the DMZ.

## 8 Firewall

- Servers of the DMZ have no access to the stations of the LAN. That guarantees that no “cracked” server of the DMZ becomes a security risk for the LAN.

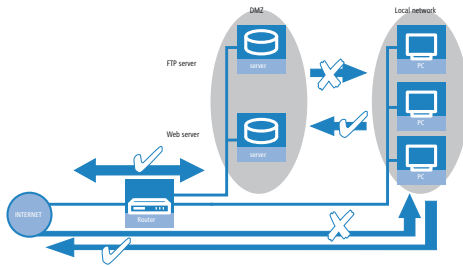

Some LANCOM models support this structure by a separate LAN interface only used for the DMZ. Looking at the path of data through the LANCOM, then the function of the Firewall for shielding the LAN against the DMZ becomes visible.

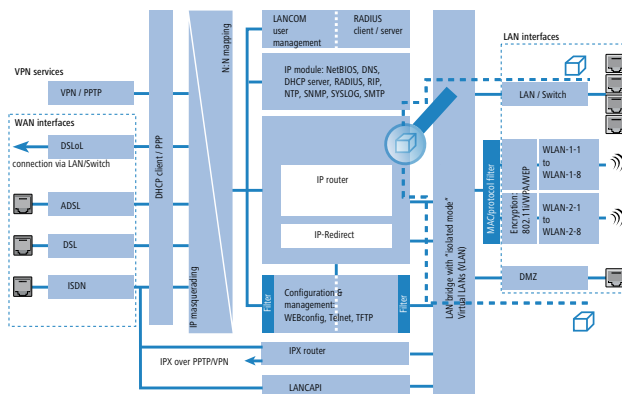

A direct data exchange between LAN and DMZ via LAN bridge is not possible if a dedicated DMZ port is used. The path from LAN to DMZ and vice versa is therefore only possible through the router, and thus also only through the Firewall! This shields the LAN against inquiries from the DMZ, similar to the LAN against inquiries from the Internet.

- ! The shielding of the DMZ against the Internet on one side and the LAN on the other is solved in many network structures with two separate Firewalls. When using a LANCOM with DMZ port, only one device for this setup is needed, which e.g. results in a clearly simplified configuration.

### 8.3.7 Hints for setting the Firewall

The LANCOM Firewall is an extremely flexible and powerful tool. In order to help you to creating individual Firewall rules, you'll find in the following some hints for your specific application

For LANCOM devices with VoIP functions that were already integrated or added in with a software option, the ports required for voice connections are activated automatically.

#### The default settings of the Firewall

On delivery there is exactly one entry in the Firewall rule table: “WINS”. This rule prevents unwanted connection set-ups on the default route (gen. to the Internet) by the NetBIOS protocol. Windows networks send inquiries in regular intervals into the network to find out if known stations are still available. This leads in case of a time-based account of a network coupling to unwanted connection set-ups.

- ! The LANCOM can prevent this by the integrated NetBIOS proxy also for network couplings, by pretending an answer for the concerned resource, until a real access takes place.

## Security by NAT and Stateful Inspection

If no further Firewall rule will be entered, the local area network is protected by the interaction of Network Address Translation and Stateful Inspection: Only connections from the local area network produce an entry in the NAT table, whereupon the LANCOM opens a communication port. The Stateful Inspection supervises communication via this port: Only packets, which belong exactly to this connection may communicate via this port. For accesses from the outside to the local network results thus an implicit "Deny All" strategy.

## Transmitting firewall rules with scripts

With the help of scripts firewall rules can easily be transmitted to device and software. Example scripts are saved in the LANCOM KnowledgeBase under [www.lancom.de/support](http://www.lancom.de/support).

 If you operate a web server in your LAN, that has been permitted access to this service from the outside, stations from the Internet can establish from the outside connections to this server. The inverse masquerading has priority over the Firewall in this case, as long as no explicit "Deny All" rule has been set.

## Set-up of an explicit "Deny All" strategy

For maximum protection and optimum control of the data traffic it is recommended to prevent first any data transfer by the Firewall. Then only the necessary functions and communication paths are allowed selectively. This offers e.g. protection against so-called "Trojans" and/or e-mail viruses, which set up actively an outgoing connection on certain ports.

## Deny All: The most important Firewall rule!

The Deny All rule is by far the most important rule to protect local networks. By this rule the Firewall operates according to the principle: "All actions, which are not explicitly allowed, remain forbidden!" Only by this strategy the administrator can be sure not to have "forgotten" an access method, because only those accesses exist, which have been opened explicitly by himself.

We recommend to set up the Deny All rule before connecting the LAN via a LANCOM to the Internet. Then you can analyse in the logging table (to start e. g. via LANmonitor), which connection attempts have been blocked by the Firewall. With the help of this information the Firewall and the "Allow rules" can be gradually extended.

Some typical applications are shown in the following.

 All filters described here can be installed very comfortably with the Firewall wizard, and if necessary be further refined with e.g. LANconfig.

- Example configuration "Basic Internet"

Rule name	Source	Destination	Action	Service (target port)
ALLOW_HTTP	Local network	All stations	transmit	HTTP, HTTPS
ALLOW_FTP	Local network	All stations	transmit	FTP
ALLOW_EMAIL	Local network	All stations	transmit	MAIL, NEWS
ALLOW_DNS_FORWARDING	Local network	IP address of LANOM (or: Local network)	transmit	DNS
DENY_ALL	All stations	reject	reject	ANY

- If you want to permit a VPN dial-in to a LANCOM acting as VPN gateway, then you need a Firewall rule allowing incoming communication from the client to the local network:

Rule	Source	Destination	Action	Service
ALLOW_VPN_DIAL_IN	remote site name	Local network	transmit	ANY

## 8 Firewall

- In case a VPN is not terminated by the LANCOM itself (e.g. a VPN Client in the local area network, or LANCOM as Firewall in front of an additional VPN gateway), you'd have to allow IPsec and/or PPTP (for the "IPsec over PPTP" of the LANCOM VPN Client) ports additionally:

Rule	Source	Destination	Action	Service (target port)
ALLOW_VPN	VPN Client	VPN Server	transmit	IPSEC, PPTP

- For ISDN or V.110 dial-in (e.g. by HSCSD mobile phone) you have to allow the particular remote site (see also):

Rule	Source	Destination	Action	Service
ALLOW_DIAL_IN	remote site name	Local network	transmit	ANY

- For a network coupling you permit additionally the communication between the involved networks:

Rule	Source	Destination	Action	Service
ALLOW_LAN1_TO_LAN2	LAN1	LAN2	transmit	ANY
ALLOW_LAN2_TO_LAN1	LAN2	LAN1	transmit	ANY

- If you operate e.g. an own web server, you selectively allow access to the server:

Rule	Source	Destination	Action	Service (target port)
ALLOW_WEBSERVER	ANY	Webserver	transmit	HTTP, HTTPS

- For diagnostic purposes it is helpful to allow ICMP protocols (e.g. ping):

Rule	Source	Destination	Action	Service
ALLOW_PING	Local network	ANY	transmit	ICMP

These rules can now be refined as needed - e.g. by the indication of minimum and maximum bandwidths for the server access, or by a finer restriction on certain services, stations or remote sites.

-  The LANCOM automatically sorts Firewall rules when creating the filter list. Thereby, the rules are sorted into the filter list on the basis of their level of detail. First all specific rules are considered, afterwards the general ones (e.g. Deny All). Examine the filter list in case of complex rule sets, as described in the following section.



## 8.4 Configuring the firewall with LANconfig

### 8.4.1 Firewall wizard

The fastest method to configure the Firewall is provided by the Firewall wizard in LANconfig:

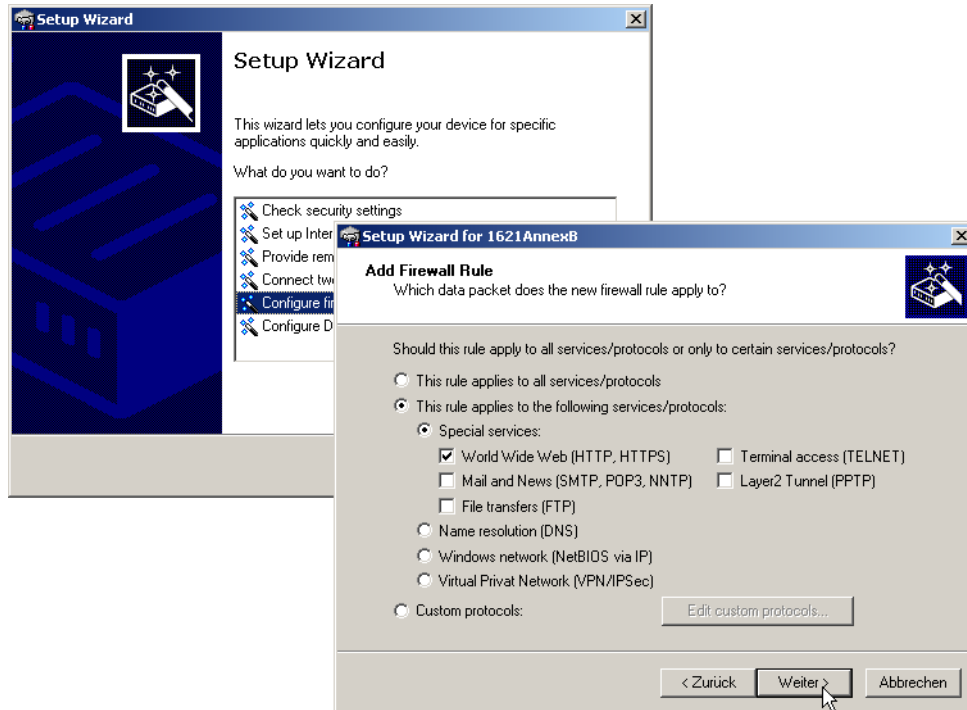

### 8.4.2 Definition of firewall objects

When configuring the firewall with LANconfig, various objects can be defined that are used in the firewall rules. This means that frequently used definitions (such as a particular action) do not need to be re-entered for every rule. Instead they can be stored once at a central location.

 Please note that a change to firewall objects affects all of the firewall rules that use this object. For this reason, all firewall rules that also use these objects are displayed when you make changes to firewall objects.

- ⓘ Existing firewalls (in the % notation) are not automatically converted to the object-orientated form when the configuration is opened in LANconfig. The LANCOM KnowledgeBase contains the pre-defined firewall settings used by the new objects.

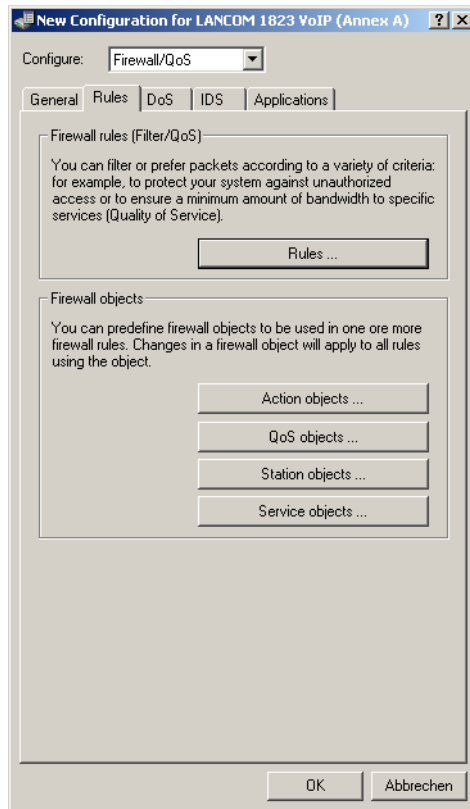

## Action objects

Here you specify here the firewall action, which is comprised of condition, limit, packet action and other measures to be used by the firewall rules.

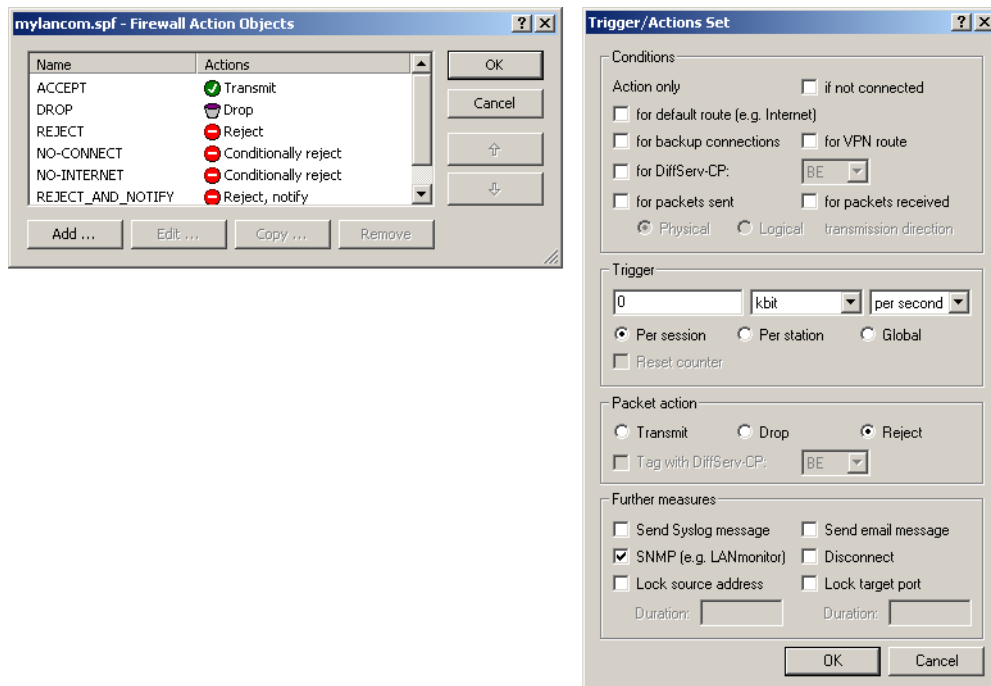

## QoS objects

Here you set the minimum bandwidths that the firewall rules allocate to data packets.

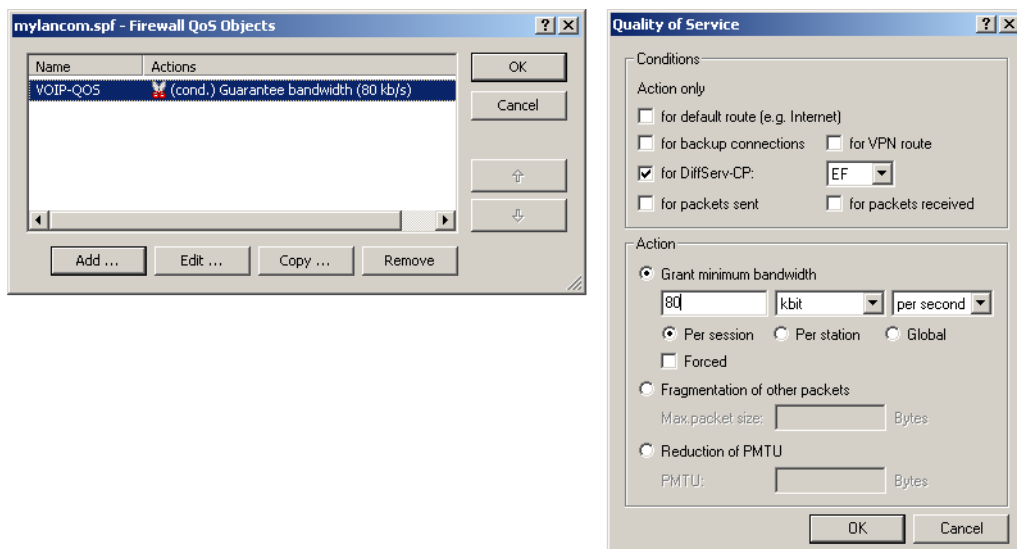

### Station objects

This is where the stations are defined that the firewall rules are to use as packet sender or addressee. The station objects are not restricted to any particular source or destination, but can be used as required by the firewall rules. In the context of Advanced Routing and Forwarding (ARF) you can specify a certain IP network as station object.

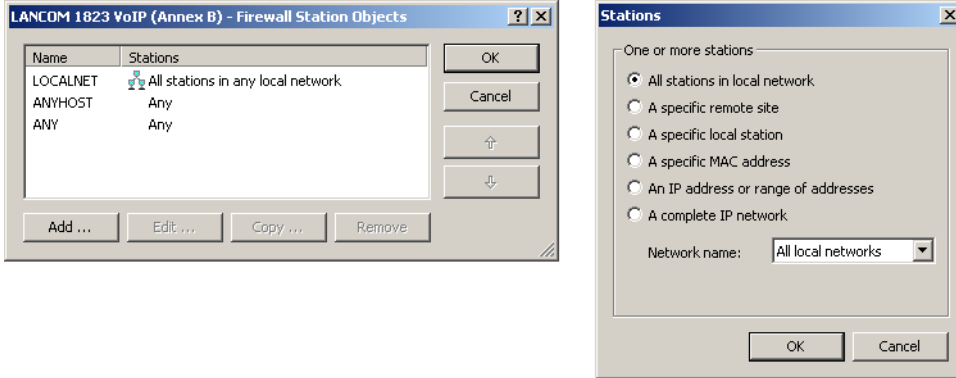

### Service objects

The IP protocols and the source/destination ports to be used by the firewall rules are defined here.

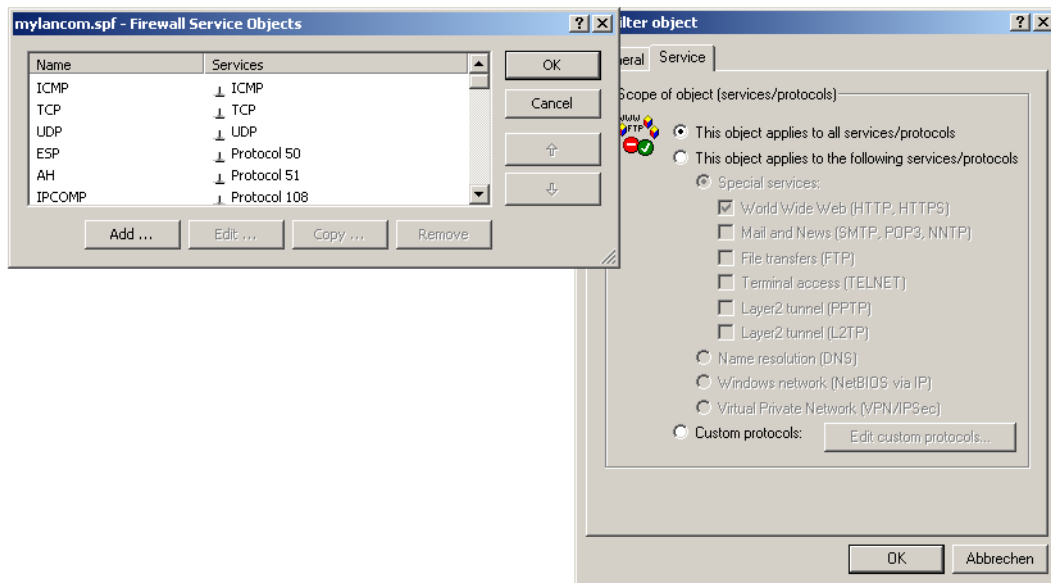

## 8.4.3 Defining firewall rules

The firewall rules are shown in a clearly laid-out table containing the following information:

- In the left-most column, icons indicate the status of the firewall rule:
  - Green check-mark: Firewall rule is enabled.
  - Red cross: Firewall rule is disabled.
  - Lock: Firewall rule is used to create VPN rules manually.
  - Two interlinked arrows: If this firewall rule applies, please observe other rules.
- Name of firewall rule

- Source
- Destination
- Source and destination service
- Action/QoS
- Comment

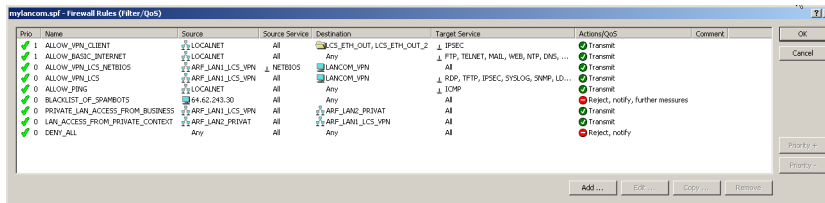

## Adding a new firewall rule

When creating a new firewall rule, the general data is entered first. Objects already defined can be selected directly from the tabs for Actions, QoS, Stations and Services. New objects that can also be used in other rules can be created here, as user-defined entries that are only to be used in the active firewall rule.

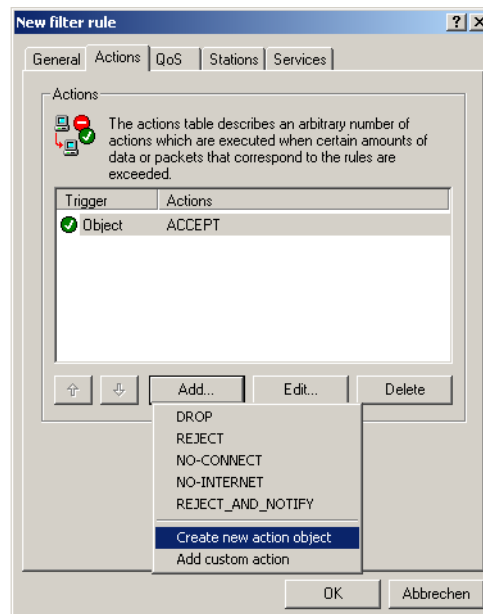
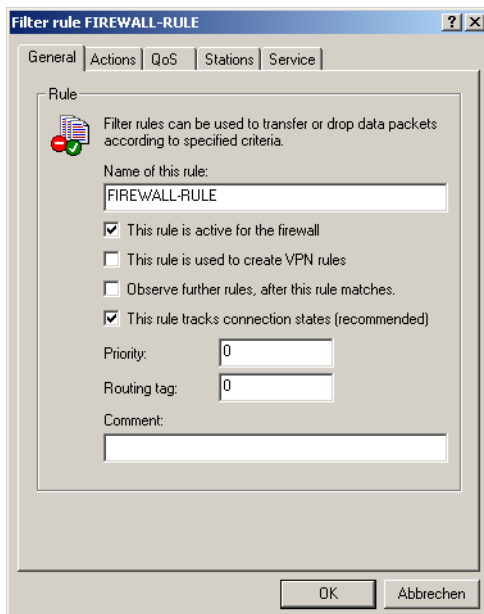

## Editing firewall rules

When editing an existing firewall rule, the user is shown whether actions, QoS, stations or services have been added as pre-defined objects. A message is displayed if you try to edit a referenced object that is already used by another firewall.

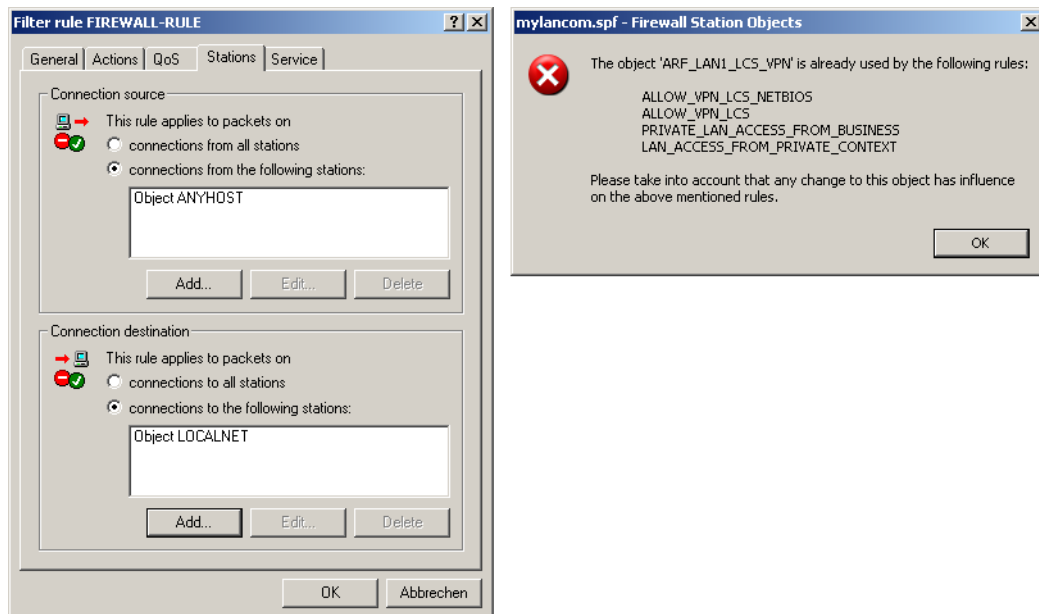

## 8.5 Configuring firewall rules with WEBconfig or Telnet

### 8.5.1 Rule table

- WEBconfig: Setup / IP router / Firewall / Rules

The rules table links various pieces of information on a firewall rule. The rule contains the protocol to be filtered, the source, the destination and the firewall action to be executed. For every firewall rule there is also an on/off switch, a priority, the option to link with other rules, and activation of the rule for VPN connections.

Just as with LANconfig, WEBconfig can be used to configure the firewall with the help of objects. The % notation described as follows is only necessary for defining objects or actions.

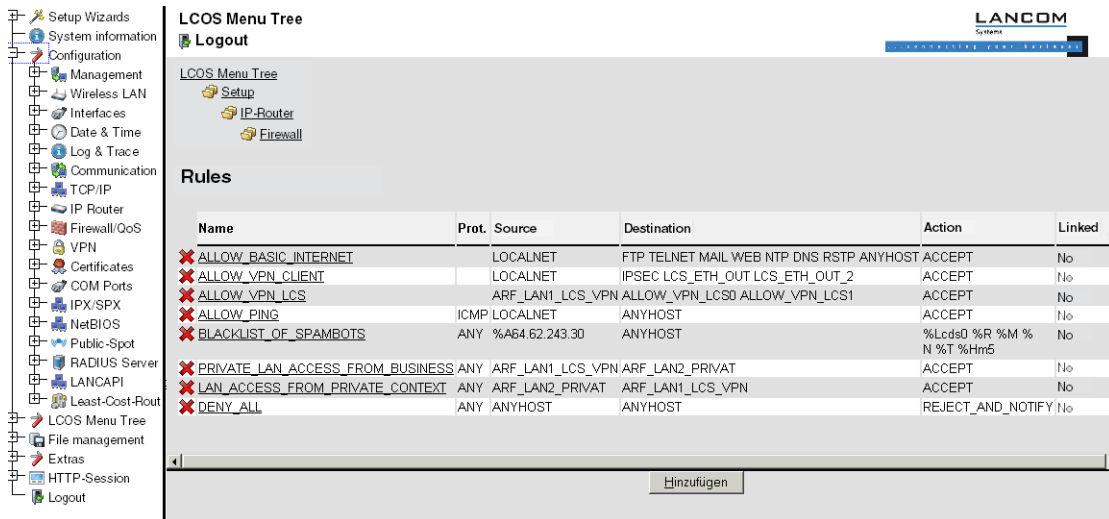

The screenshot shows the LANCOM WEBconfig interface. On the left is the 'LCOS Menu Tree' with a tree view containing categories like Setup Wizards, System information, Configuration, Management, Wireless LAN, Interfaces, Date & Time, Log & Trace, Communication, TCP/IP, IP Router, Firewall/OoS, VPN, Certificates, COM Ports, IPX/SPX, NetBIOS, Public-Spot, RADIUS Server, LANCAPI, Least-Cost-Rout, LCOS Menu Tree, File management, Extras, HTTP-Session, and Logout. The main window displays the 'Rules' table.

Name	Prot.	Source	Destination	Action	Linked
✗ ALLOW_BASIC_INTERNET		LOCALNET	FTP TELNET MAIL WEB NTP DNS RSTP ANYHOST	ACCEPT	No
✗ ALLOW_VPN_CLIENT		LOCALNET	IPSEC LCS_ETH_OUT LCS_ETH_OUT_2	ACCEPT	No
✗ ALLOW_VPN_LCS		ARF_LAN1_LCS_VPN	ALLOW_VPN_LCS0 ALLOW_VPN_LCS1	ACCEPT	No
✗ ALLOW_PING	ICMP	LOCALNET	ANYHOST	ACCEPT	No
✗ BLACKLIST_OF_SPAMROTS	ANY	%A64.62.243.30	ANYHOST	%Lcs0 %R %M %N %T %Hm5	No
✗ PRIVATE_LAN_ACCESS_FROM_BUSINESS	ANY	ARF_LAN1_LCS_VPN	ARF_LAN2_PRIVAT	ACCEPT	No
✗ LAN_ACCESS_FROM_PRIVATE_CONTEXT	ANY	ARF_LAN2_PRIVAT	ARF_LAN1_LCS_VPN	ACCEPT	No
✗ DENY_ALL	ANY	ANYHOST	ANYHOST	REJECT_AND_NOTIFY	No

! Existing firewalls in the % notation are not automatically converted to the object-orientated form. However, the LANCOM KnowledgeBase contains the pre-defined firewall settings used by the new objects.

! Devices with LCOS version 7.6 or later are automatically pre-defined with the main firewall objects. When processing older configurations with LANconfig, the firewall's standard objects are added automatically.

LCOS has a special syntax to define firewall rules. This syntax enables the representation of complex interrelationships for the testing and handling of data packets in the firewall with just a few characters. The rules are defined in the rules table. Pre-defined objects can be stored in two further tables so that frequently used objects do not have to be entered into the LCOS syntax every time:

- The firewall actions are stored in the action table
- The object table holds the stations and services

! The objects from these tables can be used for rule definition, although this is not compulsory. They merely simplify the use of frequently used objects.

The definition of firewall rules can contain entries in the object table for protocols, services, stations and the action table for firewall actions, and also direct definitions in the appropriate LCOS syntax (e.g. %P6 for TCP).

! For direct input of level parameters in the LCOS syntax, the same rules apply as specified in the following sections for protocols, source/destination and firewall actions.

## 8.5.2 Object table

- WEBconfig: Setup / IP router / Firewall / Objects

Elements/objects that are to be used in the firewall rules table are defined in the objects table. Objects can be:

- Individual computers (MAC or IP address, hostname)
- Complete networks
- Protocols
- Services (ports or port areas, e.g. HTTP, Mail&News, FTP, ...)

These elements can be combined and hierarchically structured in any way. For example, objects for the TCP and UDP protocols can be defined first. Building upon this, objects can subsequently be created, for example, for FTP (= TCP + ports 20 and 21), HTTP (= TCP + port 80) and DNS (= TCP, UDP + port 53). These can in turn be combined into one object that contains all the definitions of the individual objects.

### 8.5.3 Action table

- WEBconfig: Setup / IP Router / Firewall / Actions

A firewall action comprises of a condition, a limit, a packet action and other measures.

As with the elements of the object table, firewall actions can be given a name and be combined with each other in any way recursively. The maximum recursion depth is limited to 16. They can also be entered into the actions field of the rules table directly.

## 8.6 Firewall diagnosis

All events, conditions and connections of the Firewall can be logged and monitored in detail.

The most comfortable inspection is accomplished by displaying the logging table (see below) with LANmonitor. LANmonitor displays under 'Firewall' the last five events, that were triggered either by a Firewall rule, the DoS, or the IDS system with activated 'SNMP/LANmonitor' option.

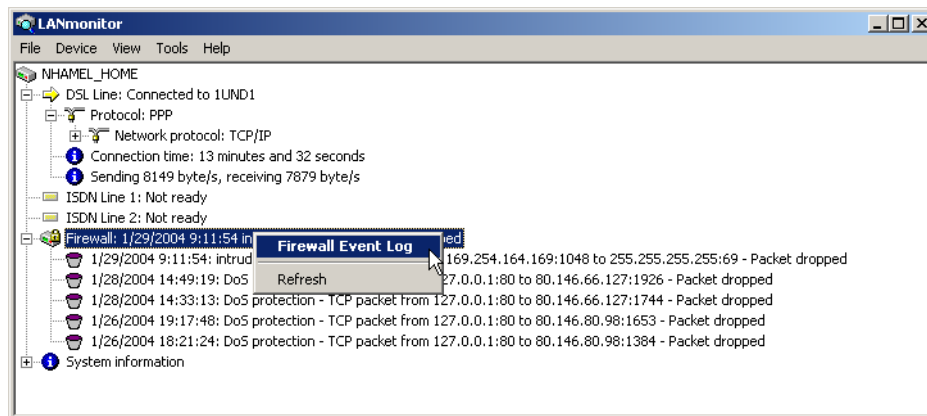

A new window with the complete logging table opens by clicking the right mouse button in the **Firewall Event Log** context menu.

All lists and tables described in this section can be found under the following menu options:

WEBconfig: LCOS menu tree / Status/ IP-Router-Statistics

### 8.6.1 The Firewall table

If an event occurred that had to be logged in either way, i.e. a log action was specified with the receipt of a packet, or a report by e-mail, Syslog or SNMP was generated, then this event is held in the logging table.



If you call up the logging table via LANmonitor, it looks like the following depiction:

Idx.	System time	Source address	Dest. address	Prot.	Source...	Dest. p...	Filter rule	Limit	Action
1	2/4/2004 12:12:41	10.1.1.11	224.0.0.9	17 (U...	520 (ro...	520 (ro...	intruder de...	Immediately	Packet dropped; SYSLOG sent
2	2/4/2004 12:11:40	10.1.1.11	255.255.255.255	17 (U...	67 (bo...	68 (bo...	intruder de...	Immediately	Packet dropped; SYSLOG sent
3	2/4/2004 12:06:45	10.1.1.11	224.0.0.9	17 (U...	520 (ro...	520 (ro...	intruder de...	Immediately	Packet dropped; SYSLOG sent
4	2/4/2004 12:05:44	10.1.1.11	255.255.255.255	17 (U...	67 (bo...	68 (bo...	intruder de...	Immediately	Packet dropped; SYSLOG sent
5	2/4/2004 12:02:32	10.1.1.11	224.0.0.9	17 (U...	520 (ro...	520 (ro...	intruder de...	Immediately	Packet dropped; SYSLOG sent
6	2/4/2004 12:01:31	10.1.1.11	255.255.255.255	17 (U...	67 (bo...	68 (bo...	intruder de...	Immediately	Packet dropped; SYSLOG sent
7	2/4/2004 12:00:04	10.1.1.11	224.0.0.9	17 (U...	520 (ro...	520 (ro...	intruder de...	Immediately	Packet dropped; SYSLOG sent
8	2/4/2004 11:59:03	10.1.1.11	10.1.255.255	17 (U...	137 (n...	137 (n...	intruder de...	Immediately	Packet dropped; SYSLOG sent
9	2/4/2004 11:55:08	10.1.1.11	224.0.0.9	17 (U...	520 (ro...	520 (ro...	intruder de...	Immediately	Packet dropped; SYSLOG sent
10	2/4/2004 11:54:07	10.1.1.11	255.255.255.255	17 (U...	67 (bo...	68 (bo...	intruder de...	Immediately	Packet dropped; SYSLOG sent
11	2/4/2004 11:48:05	10.1.1.11	224.0.0.9	17 (U...	520 (ro...	520 (ro...	intruder de...	Immediately	Packet dropped; SYSLOG sent
12	2/4/2004 11:47:04	10.1.1.11	255.255.255.255	17 (U...	67 (bo...	68 (bo...	intruder de...	Immediately	Packet dropped; SYSLOG sent
13	2/4/2004 11:45:00	10.1.1.11	224.0.0.9	17 (U...	520 (ro...	520 (ro...	intruder de...	Immediately	Packet dropped; SYSLOG sent
14	2/4/2004 11:43:59	10.1.1.11	10.1.255.255	17 (U...	137 (n...	137 (n...	intruder de...	Immediately	Packet dropped; SYSLOG sent
15	2/4/2004 11:42:13	10.1.1.11	224.0.0.9	17 (U...	520 (ro...	520 (ro...	intruder de...	Immediately	Packet dropped; SYSLOG sent
16	2/4/2004 11:41:12	10.1.1.11	255.255.255.255	17 (U...	67 (bo...	68 (bo...	intruder de...	Immediately	Packet dropped; SYSLOG sent
17	2/4/2004 11:36:18	10.1.1.11	224.0.0.9	17 (U...	520 (ro...	520 (ro...	intruder de...	Immediately	Packet dropped; SYSLOG sent
18	2/4/2004 11:35:17	10.1.1.11	255.255.255.255	17 (U...	67 (bo...	68 (bo...	intruder de...	Immediately	Packet dropped; SYSLOG sent
19	2/4/2004 11:34:04	10.1.1.11	224.0.0.9	17 (U...	520 (ro...	520 (ro...	intruder de...	Immediately	Packet dropped; SYSLOG sent
20	2/4/2004 11:33:03	10.1.1.11	10.1.255.255	17 (U...	137 (n...	137 (n...	intruder de...	Immediately	Packet dropped; SYSLOG sent
21	2/4/2004 11:27:37	10.1.1.11	224.0.0.9	17 (U...	520 (ro...	520 (ro...	intruder de...	Immediately	Packet dropped; SYSLOG sent
22	2/4/2004 11:26:36	10.1.1.11	255.255.255.255	17 (U...	67 (bo...	68 (bo...	intruder de...	Immediately	Packet dropped; SYSLOG sent
23	2/4/2004 11:21:49	10.1.1.11	224.0.0.9	17 (U...	520 (ro...	520 (ro...	intruder de...	Immediately	Packet dropped; SYSLOG sent
24	2/4/2004 11:20:48	10.1.1.11	255.255.255.255	17 (U...	67 (bo...	68 (bo...	intruder de...	Immediately	Packet dropped; SYSLOG sent

If you call up the logging table via WEBconfig, it looks like the following depiction:

LANCOM Systems  
... connecting your business

LCOS Menu Tree

- Logout
- LCOS Menu Tree
  - Status
  - Setup
  - Firmware
  - Other
- File management
- Extras
- HTTP-Session
- Logout

Log-Table

Idx.	System-time	Src-Address	Dst-Address	Prot.	Src-Port	Dst-Port	Filter-Rule	Limit	Threshold	Action
0001	05/29/2009 09:34:58	192.168.61.1	207.46.232.182	17	123	123	intruder detection	00000001	0	40000800
0002	05/28/2009 19:56:13	192.168.202.1	10.1.1.3	6	48964	139	intruder detection	00000001	0	40000800
0003	05/28/2009 09:34:52	192.168.8.1	10.1.1.5	6	35376	139	intruder detection	00000001	0	40000800
0004	05/28/2009 09:09:39	192.168.202.1	10.1.1.3	6	34920	139	intruder detection	00000001	0	40000800
0005	05/28/2009 08:38:51	192.168.8.1	10.1.1.5	6	34346	139	intruder detection	00000001	0	40000800
0006	05/28/2009 03:18:02	213.37.14.89	78.34.139.242	0	0	0	intruder detection	00000001	0	40000100
0007	05/27/2009 18:08:41	220.181.58.101	78.34.148.118	0	0	0	intruder detection	00000001	0	40000100
0008	05/27/2009 12:08:47	210.51.171.74	78.34.135.122	0	0	0	intruder detection	00000001	0	40000100
0009	05/27/2009 10:50:25	192.168.61.1	207.46.232.182	17	123	123	intruder detection	00000001	0	40000800
000a	05/27/2009 09:58:45	192.168.202.1	10.1.1.5	6	10247	139	intruder detection	00000001	0	40000800
000b	05/27/2009 08:50:24	192.168.61.1	207.46.232.182	17	123	123	intruder detection	00000001	0	40000800

Update  
Monitor this Table Update Interval (s): 5

The table contains the following values:

Element	Element meaning
Idx.	Current index (so that the table can be polled also via SNMP)
System time	System time in UTC codification (will be transformed on displaying of the table into clear text)
Src address	Source address of the filtered packet
Dst address	Destination address of the filtered packet
Prot.	Protocol (TCP, UDP etc.) of the filtered packet
Src-p	Source port of the filtered packet (only with port-related protocols)
Dst-p	Destination port of the filtered packet (only with port-related protocols)
Filter-Rule	Name of the rule, which has raised the entry.
Limit	Bit field, which describes the crossed limit, which has filtered the packet. The following values are defined at present: 0x01 Absolute number 0x02 Number per second 0x04 Number per minute 0x08 Number per hour 0x10 Global limit 0x20 Byte limit (if not set, it concerns a packet-related limit) 0x40 Limit applies only in receiving direction 0x80 limit applies only in transmission direction
Threshold	Exceeded limit value of the trigger limit

Element	Element meaning
Action	Bit field, which specifies all implemented actions. At present the following values are defined: 0x00000001 Accept 0x00000100 Reject 0x00000200 Connect filter 0x00000400 Internet- (Default route-) filter 0x00000800 Drop 0x00001000 Disconnect 0x00004000 Block source address 0x00020000 Block destination address and port 0x20000000 Send SYSLOG notification 0x40000000 Send SNMP trap 0x80000000 Send email

! All Firewall actions are likewise displayed within the IP router trace. Furthermore, some LANCOM models have a Firewall LED, which signals each filtered packet.

### 8.6.2 The filter list

The filter list allows to examine filters generated by rules defined in the action, object and rule table.

! Please note that manually entered filter rules do not generate a fault indication and also no error message. If you configure filters manually, you should in each case examine on the basis of the filter list whether the desired filters were generated or not.

On Telnet level, the content of the filter list can be displayed with the command `show filter`:

```

Telnet 10.1.140.160
#
! LANCOM 1621 ADSL/ISDN <Annex A>
! Ver. 3.30.0031 / 26.01.2004 / 5.00.50
! SN. 089540209081
! Copyright (c) LANCOM Systems
1621AnnexA, Verbindung Nr.: 002 <LAN>
1621AnnexA:/
> show filter

Filter 0001 from Rule WINS:
 Protocol: 17
 Src: 00:00:00:00:00:00 0.0.0.0 0.0.0.0 137-139
 Dst: 00:00:00:00:00:00 0.0.0.0 0.0.0.0 0-0
 Limit per conn.: after transmitting or receiving of 0 kilobits per second
 actions after exceeding the limit:
 reject

Filter 0002 from Rule WINS:
 Protocol: 6
 Src: 00:00:00:00:00:00 0.0.0.0 0.0.0.0 137-139
 Dst: 00:00:00:00:00:00 0.0.0.0 0.0.0.0 0-0
 Limit per conn.: after transmitting or receiving of 0 kilobits per second
 actions after exceeding the limit:
 reject

```

Under WEBconfig the filter list has the following structure:

Idx.	Prot.	Src-MAC	Src-Address	Src-Netmask	S-St	S-End	Dst-MAC	Dst-Address	Dst-Netmask	D-St	D-End	Action	Linked
0001	6	000000000000	192.168.2.0	255.255.255.0	0	0	000000000000	0.0.0.0	0.0.0.0	8080	8080	limit: accept	No
0002	6	000000000000	192.168.2.0	255.255.255.0	0	0	000000000000	0.0.0.0	0.0.0.0	8008	8008	limit: accept	No
0003	6	000000000000	192.168.2.0	255.255.255.0	0	0	000000000000	0.0.0.0	0.0.0.0	591	591	limit: accept	No
0004	6	000000000000	192.168.2.0	255.255.255.0	0	0	000000000000	0.0.0.0	0.0.0.0	443	443	limit: accept	No
0005	6	000000000000	192.168.2.0	255.255.255.0	0	0	000000000000	0.0.0.0	0.0.0.0	80	80	limit: accept	No
0006	6	000000000000	0.0.0.0	0.0.0.0	0	0	000000000000	0.0.0.0	0.0.0.0	21	21	limit: accept	No
0007	6	000000000000	192.168.2.0	255.255.255.0	0	0	000000000000	0.0.0.0	0.0.0.0	995	995	limit: accept	No
0008	6	000000000000	192.168.2.0	255.255.255.0	0	0	000000000000	0.0.0.0	0.0.0.0	143	143	limit: accept	No
0009	6	000000000000	192.168.2.0	255.255.255.0	0	0	000000000000	0.0.0.0	0.0.0.0	119	119	limit: accept	No
000a	6	000000000000	192.168.2.0	255.255.255.0	0	0	000000000000	0.0.0.0	0.0.0.0	110	110	limit: accept	No
000b	6	000000000000	192.168.2.0	255.255.255.0	0	0	000000000000	0.0.0.0	0.0.0.0	25	25	limit: accept	No

The individual fields in the filter list have the following meaning:

Entry	Description
Idx.	Current index
Prot	Protocol to be filtered, e.g. 6 for TCP or 17 for UDP.
Src MAC	Ethernet source address of the packet to be filtered or 000000000000, if the filter should apply to all packets.
Src address	Source IP address or 0.0.0.0, if the filter should apply to all packets.
Source mask	Source network mask, which determinates the source network together with the source IP address, or 0.0.0.0, if the filter should apply to packets from all networks.
Q start	Start source port of the packets to be filtered.
Q end	End source port of the packets to be filtered. Makes up the port range together with the start source port, in which the filter takes effect. If start and end port are 0, then the filter is valid for all source ports.
Dst MAC	Ethernet destination address of the packet to be filtered or 000000000000, if the filter should apply to all packets.
Dst address	Destination address or 0.0.0.0, if the filter should apply to all packets.
Dst mask	Destination network mask, which determinates the destination network together with the destination IP address, or 0.0.0.0, if the filter should apply to packets to all networks.
Z start	Start destination port of the packets to be filtered.
Z end	Destination port of the packets to be filtered. Makes up the port range together with the start destination port, in which the filter takes effect. If start and end port are 0, so the filter is valid for all destination ports.
Action	Into this column, the "main action" is unveiled as a text, which will be executed when the first limit has been exceeded. The first limit can be also an implicit limit, e.g. if only one limit for the restriction of the throughput was configured. Then an implicit limit - linked with an "accept" action - is inserted. In this case, "accept" is unveiled as main action. You can see the complete actions under the command show filter.
Linked	Indicates whether it concerns a "first Match" rule (linked = no). Only with linked rules in the case of applying of this rule, also further rules are evaluated.
Prio	Priority of the rule having generated the entry.

### 8.6.3 The connection list

The connection table files source address, destination address, protocol, source port, destination port, etc. of a connection, as well as possible actions. This table is sorted according to source address, destination address, protocol, source port and destination port of the packet, which caused the entry in the table.

Under WEBconfig the filter list has the following structure:

The screenshot shows the LANCOM WEBconfig interface. On the left is a menu tree with options like Setup Wizards, System information, Configuration, LCOS Menu Tree, Status, Setup, Firmware, Other, File management, Extras, HTTP-Session, and Logout. The main area displays the 'Connection-List' table with the following data:

Src-Address	Dst-Address	Prot.	Src-Port	Dst-Port	Rtg-tag	Timeout	Flags	Filter-Rule	Src-Route	Dest-Route
192.168.2.37	74.125.77.99	6	3571	80	0	179	80020008	ALLOW_HTTP	NETCOLOGN	NETCOLOGN
192.168.2.37	74.125.77.99	6	3572	80	0	179	80020008	ALLOW_HTTP	NETCOLOGN	NETCOLOGN
192.168.2.37	74.125.77.100	6	4206	80	0	122	80020008	ALLOW_HTTP	NETCOLOGN	NETCOLOGN
192.168.2.37	87.248.198.117	6	3411	80	0	300	80020008	ALLOW_HTTP	NETCOLOGN	NETCOLOGN
192.168.2.43	74.125.77.104	6	60469	80	0	276	80020008	ALLOW_HTTP	NETCOLOGN	NETCOLOGN
192.168.2.43	74.125.77.104	6	60470	80	0	276	80020008	ALLOW_HTTP	NETCOLOGN	NETCOLOGN
192.168.2.49	80.237.132.11	6	4617	80	0	2	80020038	ALLOW_HTTP	NETCOLOGN	NETCOLOGN

At the bottom of the table, there are buttons for 'Monitor this Table' and 'Update Interval (s): 5'.

The table contains the following elements:

Element	Element meaning
Src addr.	Source address of the connection
Dst addr.	Destination address of the connection
Protocol	Used protocol (TCP/UDP etc.). The protocol is decimally indicated.
Src port	Source port of the connection. The port is only indicated with port-related protocols (TCP/UDP) or protocols, which own a comparable field (ICMP/GRE).
Dst port	Destination port of the connection (with UDP connections, this one is occupied only with the first answer).
Timeout	Each entry ages out with the time of this table, thus the table does not overflow with "died" connections.
Flags	In the flags the condition of the connection and further (internal) information are stored in a bit field. As conditions the following values are possible: new, establish, open, closing, closed, rejected (corresponding to the TCP flags: SYN, SYN ACK, ACK, FIN, FIN ACK and RST).  UDP connections know the conditions new, open and closing (the last one only, if the UDP connection is linked with a condition-afflicted control path. This is e.g. the case with protocol H.323.).
Src route	Name of the remote station, over which the first packet has been received.
Dst route	Name of the remote station, where the first packet will be sent to.
Filter rule	Name of the rule, which has generated the entry (determines also the actions to be executed), when a suitable packet is received.

Meaning of the flags of the connection list

Flag	Flag meaning
00000001	TCP: SYN sent
00000002	TCP: SYN/ACK received
00000004	TCP: waiting for ACK of the server
00000008	all: open connection
00000010	TCP: FIN received
00000020	TCP: FIN sent
00000040	TCP: RST sent or received

Flag	Flag meaning
00000080	TCP: session will be re-established
00000100	FTP: passive FTP connection will be established
00000400	H.323: belonging to T.120 connection
00000800	connection via loopback interface
00001000	checking concatenated rules
00002000	rule is catenated
00010000	destination is on "local route"
00020000	destination is on default route
00040000	destination is on VPN route
00080000	physical connection is not established
00100000	source is on default route
00200000	source is on VPN route
00800000	no route for destination
01000000	contains global actions with condition

### 8.6.4 Port block list

Address, protocol and port of a destination station are filed in the port block list, if blocking of the destination port on the destination station was selected as a filter's packet action. This table is likewise a sorted semi-dynamic table. Sorting is done according to address, protocol and port. The table contains the following elements:

Element	Element meaning
Address	Address of the station, to which the blocking should apply.
Protocol	Used protocol (TCP/UDP etc.) The protocol is decimally indicated.
Port	Port to close at the station. If the respective protocol is not port related, then the entire protocol for this station becomes closed.
Timeout	Duration of the blocking in minutes.
Filter rule	Name of the rule, which has produced the entry (determines also the actions to be executed), when a suitable packet is received.

### 8.6.5 Host block list

The address of a station is filed in the host block list, if blocking of the sender was selected in a filter's packet action. This table is a sender address sorted semi-dynamic table and contains the following elements:

Element	Element meaning
Address	Address of the station, to which the blocking should apply.
Timeout	Duration of the blocking in minutes.
Filter rule	Name of the rule, which has generated the entry (determines also the actions to be executed), when a suitable packet is received.

## 8.7 Firewall limitations

Apart from understanding the functioning of Firewalls, it is also very important to discern their limitations and to extend them if necessary. The Firewall does not protect against malicious contents coming through the permitted ways into your local network. It is true that certain effects of some viruses and worms are stopped, because communication is blocked via the required ports, but no Firewall alone is a comprehensive protection against viruses.

Also monitoring of sensitive data in the Internet is not prevented by a Firewall. If data once reaches the unsecured net beyond the Firewall, then it is exposed to well-known dangers. Despite using a Firewall, any confidential information such as contracts, passwords, development information etc. should be transmitted only over protected connections, i.e. by using suitable data encryption and VPN connections.

## 8.8 Protection against break-in attempts: Intrusion Detection

A Firewall has the task to examine data traffic across borders between networks, and to reject those packets, which do not have a permission for transmission. Beside attempts to access directly a computer in the protected network, there are also attacks against the Firewall itself, or attempts to outwit a Firewall with falsified data packets.

Such break-in attempts are recognized, repelled and logged by the Intrusion Detection system (IDS). Thereby it can be selected between logging within the device, email notification, SNMP traps or SYSLOG alarms. IDS checks the data traffic for certain properties and detects in this way also new attacks proceeding with conspicuous patterns.

### 8.8.1 Examples for break-in attempts

Typical break-in attempts are falsified sender addresses ("IP Spoofing") and port scans, as well as the abuse of special protocols such as e.g. FTP in order to open a port on the attacked computer and the Firewall in front of it.

#### IP Spoofing

With IP Spoofing the sender of a packet poses itself as another computer. This happens either in order to trick the Firewall, which trusts packets from the own network more than packets from untrusted networks, or in order to hide the author of an attack (e.g. Smurf).

The LANCOM Firewall protects itself against spoofing by route examination, i.e. it examines, whether a packet was allowed to be received over a certain interface at all, from which it was received.

#### Portscan Detection

The Intrusion Detection system tries to recognize Portscans, to report and to react suitably on the attack. This happens similarly to the recognition of a 'SYN Flooding' attack: The "half-open" connections are counted also here, whereby a TCP RESET, which is sent by the scanned computer, leaves a "half-open" connection open again.

If a certain number of half-open connections between the scanned and the scanning computer exist, then this is reported as a port scan.

Likewise, the receipt of empty UDP packets is interpreted as an attempted port scan.

## 8.8.2 Configuration of the IDS

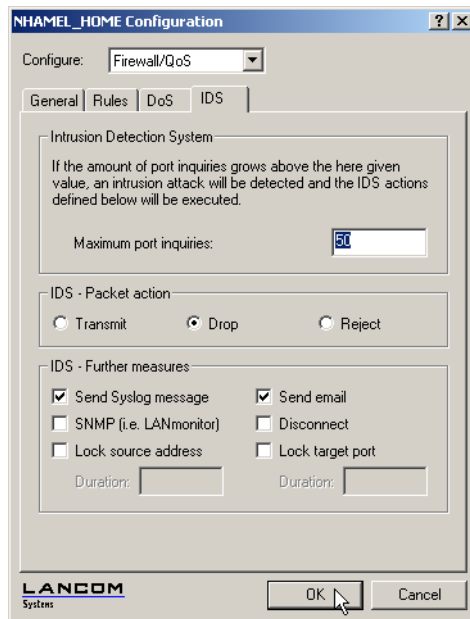

LANconfig: Firewall/QoS / IDS

WEBconfig: LCOS menu tree / Setup / IP-Router / Firewall

Apart from the maximum number of port inquiries, fragment action and the possible registration mechanisms, also these reactions are possible:

- The connection will be cut off.
- The sender address will be blocked for an adjustable period of time.
- The destination port of the scan will be blocked for an adjustable period of time.

## 8.9 Protection against "Denial of Service" attacks

Attacks from the Internet can be break-in attempts, as well as attacks aiming to block the accessibility and functionality of individual services. Therefore a LANCOM is equipped with appropriate protective mechanisms, which recognize well-known hacker attacks and which guarantee functionality.

### 8.9.1 Examples of Denial of Service Attacks

Denial of service attacks do profit from fundamental weaknesses of TCP/IP protocols, as well as from incorrect implementations of TCP/IP protocol stacks. Attacks, which profit from fundamental weaknesses are e.g. SYN Flood and Smurf. Attacks aiming at incorrect implementations are all attacks, which operate with incorrectly fragmented packets (e.g. Teardrop), or which work with falsified sender addresses (e. g. Land). In the following some of these attacks are described, their effects and possible countermeasures.

#### SYN Flooding

SYN Flooding means that the aggressor sends in short distances TCP packets with set SYN flag and with constantly changing source ports on open ports of its victim. The attacked computer establishes as a result a TCP connection, replies to the aggressor a packet with set SYN and ACK flags and waits now in vain for the confirmation of the connection establishment. Hundreds of "half-open" TCP connections are staying thereby, and just consume resources (e.g. memory)

of the attacked computer. This procedure can go that far that the victim can accept no more TCP connection or crashes due to the lack of memory.

An appropriate countermeasure of a Firewall is to supervise the number of "half-open" TCP connections, which exists between two stations and to limit it. That means, if further TCP connections between these workstations were established, these connections would be blocked by the Firewall.

## Smurf

The Smurf attack works in two stages and paralyzes two networks at once. In the first step a Ping (ICMP echo Request) packet with a falsified sender address is sent to the broadcast address of the first network, whereupon all workstations in this network answer with an ICMP echo Reply to the falsified sender address, which is located in the second network. If the rate of incoming echo requests is high enough, as well as the number of answering workstations, then the entire incoming traffic of the second network is blocked during the attack and, moreover, the owner of the falsified address cannot receive normal data any more during the attack. If the falsified sender address is the broadcast address of the second network, also all workstations are blocked in this network, too.

In this case the DoS recognition of the LANCOM blocks passing packets, which are addressed to the local broadcast address.

## LAND

The land attack is a TCP packet that is sent with set SYN flag and falsified sender address to the victim workstation. The bottom line is that the falsified sender address is equal to the address of the victim. With an unfortunate implementation of TCP, the victim interprets the sent SYN-ACK again as SYN, and a new SYN-ACK is sent. This leads to a continuous loop, which lets the workstation freeze.

In a more up to date variant, the loopback address "127.0.0.1" is taken as sender address, but not the address of the attacked workstation. Sense of this deception is to outwit personal firewalls, which react in fact to the classical variant (sender address = destination address), but which pass through the new form without hindrance. This variant is also recognized and blocked by a LANCOM.

## Ping of Death

The Ping of Death belongs to those attacks, which use errors when fragmented packets are reassembled. This functions as follows:

In the IP header there is a field "fragment offset" that indicates in which place the received fragment is to be assembled into the resulting IP packet. This field is 13 bits long and gives the offset in 8 byte steps, and can form an offset from 0 to 65528. With a MTU on the Ethernet of 1500 bytes, an IP packet can be made up to  $65528 + 1500 - 20 = 67008$  bytes. This can lead to an overrun of internal counters or to buffer overruns, and thus it can provoke the possibility to the aggressor of implementing own code on the victim workstation.

In this case, the Firewall offers two possibilities:

Either, the Firewall reassembles the entire incoming packet and examines its integrity, or solely the fragment which goes beyond the maximum packet size is rejected. In the first case, the Firewall itself can become the victim when its implementation was incorrect. In the second case "half" reassembled packets accumulate at the victim, which are only rejected after a certain time, whereby a new Denial of Service attack can result thereby if the memory of the victim is exhausted.

## Teardrop

The Teardrop attack works with overlapping fragments. After the first fragment another one is sent, which overlaps completely within the first one, i.e. the end of the second fragment is located before the end of the first. If - due to the indolence of the IP stack programmer - it is simply counted "new end" - "old end" when determining the number of bytes to copy for the reassembly, then a negative value results, resp. a very large positive value, by which during the copy operation parts of the memory of the victim are overwritten and thereupon the workstation crashes.

The Firewall has again two possibilities:



Either the Firewall reassembles and rejects if necessary the entire packet, or it holds only minimum offset and maximum end of the packet and rejects all fragments, whose offset or end fall into this range. In the first case the implementation within the Firewall must be correct, so that the Firewall does not become the victim itself. In the other case "half" reassembled packets accumulate again at the victim.

### Bonk/Fragrouter

Bonk is a variant of the Teardrop attack, which targets not at crashing the attacked computer, but to trick simple port filter Firewalls, which accept also fragmented packets and thus to penetrate into the network being protected. During this attack, the UDP or TCP Header of the first fragment is overwritten by skillful choice of the fragment offset. Thereby, simple port filter Firewalls accept the first packet and the appropriate fragments while overwriting the first packet's header by the second fragment. Thus suddenly a permissible packet is created, which rather actually should be blocked by the Firewall.

Concerning this occurrence, the Firewall can itself either reassemble or filter only the wrong fragment (and all following), leading to the problems already indicated by either one of the other solutions above.

- ! By default installation all items are configured as "secure", i.e. maximal 100 permissible half-open connections by different workstations (see SYN Flooding), at most 50 half-open connections of a single computer (see Portscan) of fragmented packets to be reassembled.

## 8.9.2 Configuration of DoS blocking

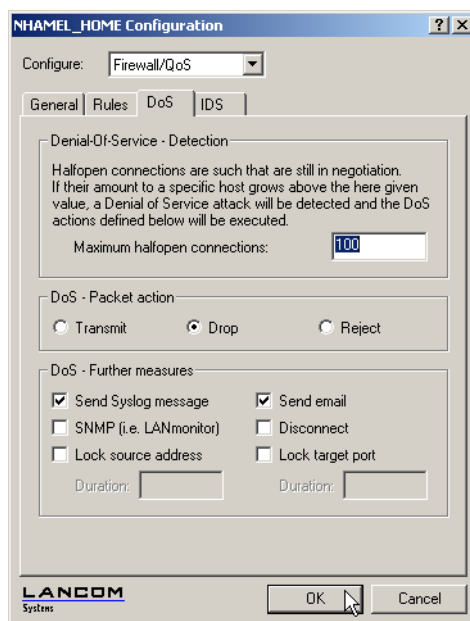

LANconfig: Firewall/QoS / DoS

WEBconfig: LCOS menu tree / Setup / IP-Router / Firewall

- ! In order to drastically reduce the susceptibility of the network for DoS attacks in advance, packets from distant networks may be only accepted, if either a connection has been initiated from the internal network, or the incoming packets have been accepted by an explicit filter entry (source: distant network, destination: local area network). This measure already blocks a multitude of attacks.

For all permitted accesses explicitly connection state, source addresses and correctness of fragments are tracked in a LANCOM. This happens for incoming and for outgoing packets, since an attack could be started also from within the local area network.

This part is configured centrally in order not to open a gate for DoS attacks by incorrect configuration of the Firewall. Apart from specifying the maximum number of half-open connections, fragment action and possible notification mechanisms, also these more extensive possibilities of reaction exist:

- The connection will be cut off.
- The sender address will be blocked for an adjustable period of time.
- The destination port of the scan will be blocked for an adjustable period of time.

However, always active are the following protection mechanisms:

- Address examination (against IP Spoofing)
- Blocking of broadcasts into local area network (against Smurf and Co).

### 8.9.3 Configuration of ping blocking and Stealth mode

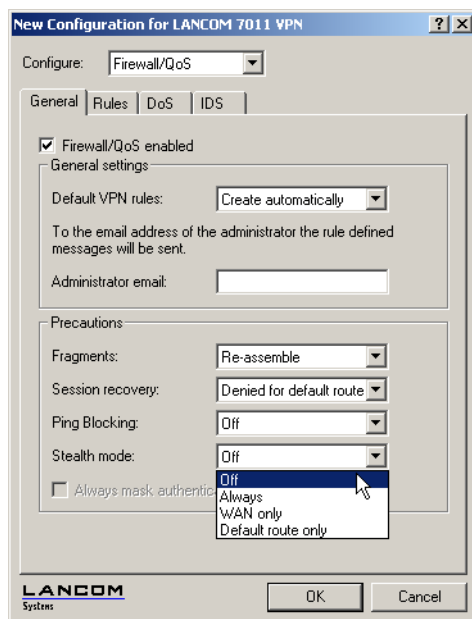

LANconfig: Firewall/QoS / General

WEBconfig: LCOS menu tree / Setup / IP-Router / Firewall

## 8.10 Addition(s) to LCOS 7.80

### 8.10.1 Increased DoS threshold value for central devices

Denial-of-Service attacks take advantage of inherent weaknesses in the TCP/IP protocol in combination with poor implementations.

- Attacks which target these inherent weaknesses include SYN Flood and Smurf.
- Attacks which target erroneous implementations include those operating with erroneously fragmented packets (e. g. Teardrop) or with fake sender addresses (e. g. Land).

Your device detects most of these attacks and reacts with appropriate countermeasures. Detecting these attacks relies on counting the number of connections which are concurrently under negotiation (half-open connections). If the number of half-open connections exceeds a certain threshold value, then the device assumes that a DoS attack is underway. The actions and measures which are taken in this case can be defined, similar to firewall rules.

- ! Central devices are connected to a large number of users, so it is possible for a large number of half-open connections to exist without being caused by a DoS attack. For this reason, a higher default threshold value is required for the accurate detection of DoS attacks.

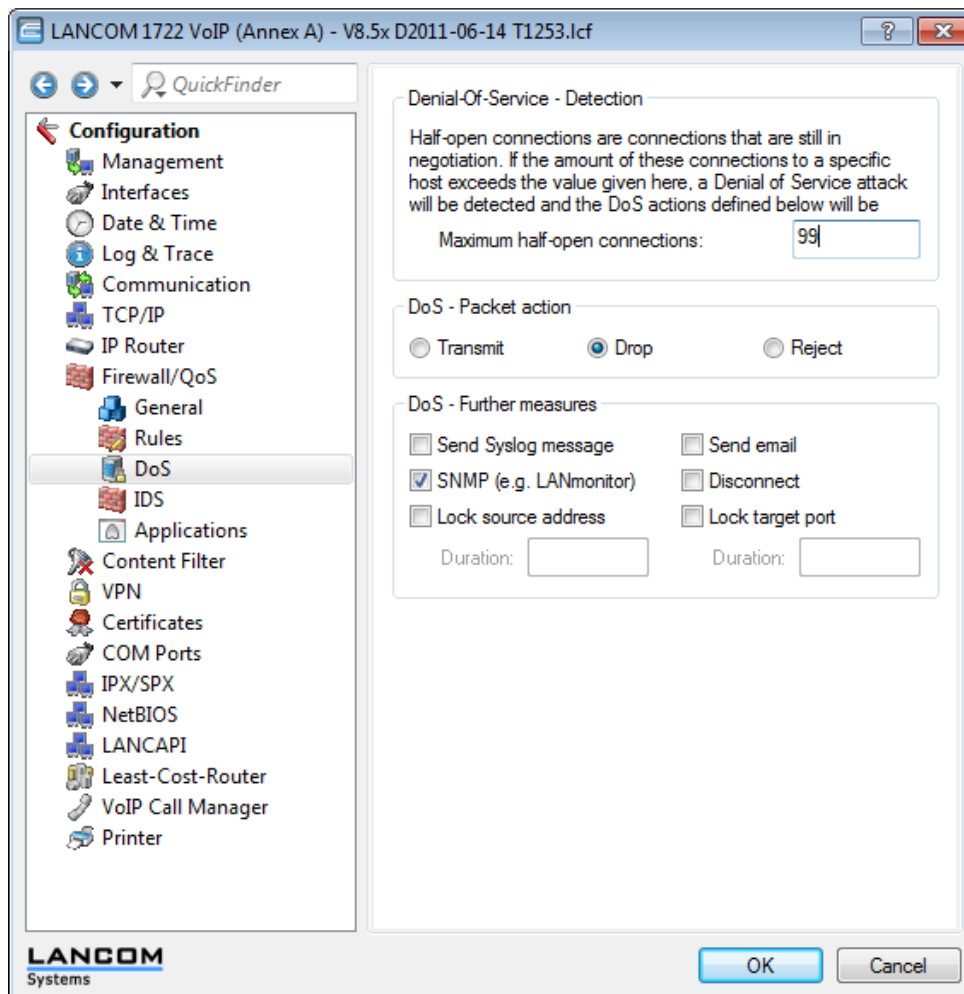

LANconfig: Firewall/QoS / DoS

WEBconfig: LCOS menu tree / Setup / IP-Router / Firewall

- Maximum half-open connections

Specifies the number of half-open connections which triggers DoS-attack countermeasures.

Possible values:

- 0 to 9999

Default:

- 100
- 1000 for central-site devices such as the 7100, 7111, 8011, 9100, 4025(+), 4100.

## 8.11 Addition(s) to LCOS 8.82

### 8.11.1 Source tags for firewall rules

#### Additions to the Setup menu

##### Source tag

The source tag (the expected interface- or routing tag) is used to identify the ARF context from which a packet was received. This can be used to restrict firewall rules to certain ARF contexts.

##### SNMP ID:

2.8.10.2.15

##### Telnet path:

**Setup > IP-Router > Firewall > Rules**

##### Possible values:

0 - 65535

##### Comment

- 65535: The firewall rule is applied if the expected interface- or routing tag is 0.
- 1 - 65534: The firewall rule is applied if the expected interface- or routing tag is 1...65534.
- 0: Wildcard. The firewall rule is applied to all ARF contexts (the expected interface- or routing tag is 0...65535).

##### Default:

0

## 9 IPv6

### 9.1 IPv6 basics

IPv4 (Internet Protocol version 4) is a protocol for unique addressing of nodes in a network and, at the time of writing, it has defined all of the IP addresses assigned globally. The limited availability of address space required the development of IPv6 (Internet Protocol version 6), which is to replace the former standard. With a different IP-address structure, IPv6 provides for a greater range of IP addresses and thus increases the possible number of participants in networks worldwide.

#### 9.1.1 Why use IPv6-standard IP addresses?

The new IPv6 standard was developed for the following reasons:

- IPv4 address space allows for approximately four billion IP addresses for unique identities in networks. When the IPv4 standard was implemented in the '80s this address space was considered to be sufficient. Due to the enormous growth of the World Wide Web and the unexpectedly large number of computers and network devices, an address shortage has arisen that the IPv6 standard is intended to bridge.
- The increase in address space with IPv6 hampers the scanning of IP addresses by viruses and Trojans. The broader spectrum provides greater protection against attacks.
- IPv6 has been implemented with a view to the security requirements. For this reason it uses the security protocol IPSec (IP Security). This provides secure network communications on layer 3 whereas many of IPv4 security mechanisms only operate on higher layers.
- Simplified, fixed descriptors for data packets save on router processing power and thus accelerate the available throughput.
- IPv6 allows for easier and faster transmission of data in real time, making it suitable for multimedia applications such as Internet telephony and Internet TV.
- So-called mobile IPs allow you to use a fixed IP address to login to different networks. This allows you to log on with your laptop using the same IP address, whether you are in your home network, in a café or at work.

#### 9.1.2 IP address structure according to the IPv6 standard

The new IPv6 addresses are 128 bits long and the range of possible addresses can cater for about 340 sextillion network participants. IPv6 addresses consist of eight blocks of 16 bits and are written as hexadecimal numbers. The following is an example of a possible IPv6 address:

**2001:0db8:0000:0000:0000:54f3:dd6b:0001/64**

To improve the legibility of these IP addresses, zeros at the beginning of a block of numbers are omitted. It is also possible to omit one group of blocks that consist entirely of zeros. For the above example, one possible representation would be as follows:

**2001:db8::54f3:dd6b:1/64**

An IPv6 address consists of two parts; a prefix and an interface identifier. The prefix denotes the membership of the IP address to a network, while the interface identifier (e.g. in the case of auto-configuration) is generated from a link-layer address, and thus belongs to a particular network card. The device can also generate interface identifiers from random numbers. This improves security. In this way, multiple IPv6 addresses can be assigned to a single component.

The prefix describes the first part of the IP address. The length of the prefix is shown as a decimal number after a slash. For the example given here the prefix is:

**2001:db8::/64**

The remainder of the IP address is the interface identifier. In our example, this is:

**::54f3:ddb6:1**

Compared with the IP addresses for the IPv4 standard, a number of changes have resulted in the structure of the new IPv6 addresses:

- While IPv4 addresses cater for an address space of 32 bits, the new length of 128 bits results in a significantly larger address space with IPv6. IPv6 addresses are four times longer than IPv4 addresses.
- An interface can have multiple IPv6 addresses due to the potential assignment of multiple prefixes to a single interface identifier. With the IPv4 standard, an interface has only one IP address.
- IPv4 addresses must be assigned by a central server. This is usually a DHCP server. However, IPv6 can operate an auto-configuration, which makes the use of a DHCP server unnecessary. However, you the option of using a DHCP server is still open to you.

### 9.1.3 Stages of migration

IPv6 is available to networks in a variety of ways. We make a distinction between environments with native IPv6 and those which provide IPv6 through a tunnel.

- **Native IPv6:** Native IPv6 describes a network that communicates to the outside only via IPv6. Users with IPv4 addresses can only access this network by communicating through a gateway that mediates between IPv6 and IPv4 networks.
- **IPv6 via dual stack:** Dual stack refers to the parallel operation of IPv4 and IPv6 in a network. A router mediates between devices that "speak" only IPv4 or IPv6. The clients select the protocol they need.
- **IPv6 tunneling:** If a router does not have IPv6 Internet access, it can still access IPv6 networks by means of a tunnel.

## 9.2 IPv6 tunneling technologies

### 9.2.1 6in4 tunneling

6in4 tunnels are used to connect two hosts, routers, or to interconnect a host and router. This means that 6in4 tunnels can connect two IPv6 networks via an IPv4 network. The diagram shows a static 6in4 tunnel between the local router and a 6in4 gateway belonging to a tunnel broker.

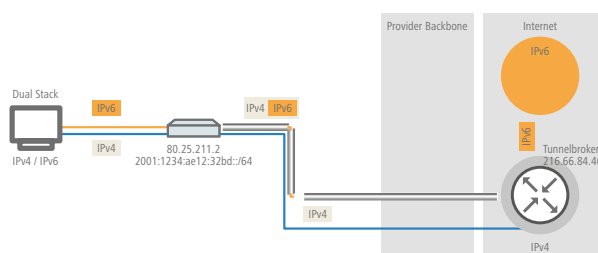

Unlike 6to4, these are dedicated services operated by a known provider. The end-points are fixed and the tunnel broker assigns a static prefix. The advantages of a 6in4 solution are that the gateways are fixed and the operator is known. The fixed prefix from the tunnel broker also determines the number of possible subnets that can be used. A 64-bit prefix (e. g. 2001:db8::/64) allows one subnet to be used. If a 48-bit prefix is used, 16 bits of the 64-bit prefix are available for use. This allows the implementation of up to 65,536 subnets.

The disadvantage of the 6in4 technology is the higher administrative effort. You must be registered with and login to the tunnel broker. In addition, the tunnel endpoints must be statically configured. Where a dynamic IPv4 address is used, the relevant data must be updated regularly. This can be automated by running a script on a router.

6in4 is a relatively secure and stable technology for providing IPv6 Internet access. This technology is thus suitable for operating web servers that are to be accessed over IPv6. The only drawback is the increased effort in administration. This technology is also suitable for professional use.

## 9.2.2 6rd tunneling

6rd (rapid deployment) is a development of 6to4. The underlying function is identical. The difference is that just one particular relay is used, as operated by a provider. This solves the two basic problems of the 6to4 technology—the lack of security and stability. The prefix with 6rd is either configured manually or sent via DHCP (IPv4), which further reduces the effort involved with configuration. The diagram is a schematic representation of a 6rd scenario.

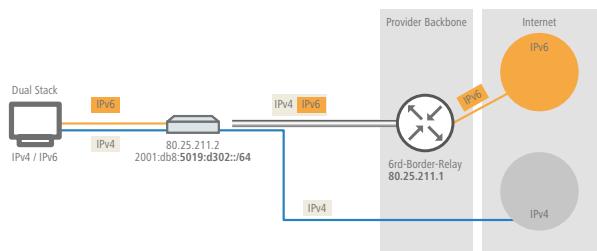

The provider assigns the router with a prefix (2001:db8::/32), which the router then supplements with its own IPv4 address. The IPv6 address generated in this way has the form: 2001:db8:5019:d302::/64. This makes 6rd interesting from two perspectives. The provider has a simple way to give its customers access to the IPv6 Internet. In addition, customers benefit from greatly simplified usage. They do not have to accept the security risks of 6to4, nor do they have to handle the complicated configuration of 6in4.

## 9.2.3 6to4 tunneling

6to4 tunneling offers you an easy way to set up a connection between two IPv6 networks via an IPv4 network. To this end, what is known as a 6to4 tunnel is set up:

- A router between the local IPv6 network and an IPv4 network serves to mediate between the networks.
- The router has both a public IPv4 address and an IPv6 address. The IPv6 address consists of an IPv6 prefix and the IPv4 address in hexadecimal notation. If a router such as has the IPv4 address 80.25.211.2, this will first be converted into hexadecimal notation: 5019:d302. Supplementing this is an IPv6 prefix (e.g. 2002::/16), so that the IPv6 address for the router appears as follows: 2002:5019:d302::/48.
- If a device in the IPv6 network sends data packets via the router to a destination address in the IPv4 network, then the router first of all repacks the IPv6 packets and encapsulates them into a package with an IPv4 header. The router then forwards the encapsulated package to a 6to4 relay. The 6to4 relay unpacks the packet and forwards it to the desired destination. The following illustration shows the operating principle of 6to4 tunneling:

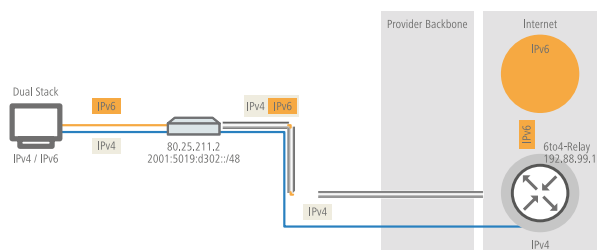

6to4 tunnels establish a dynamic connection between IPv6 and IPv4 networks: the response packets may be routed back via a different 6to4 relay. 6to4 tunnels are not a point-to-point connection. For every new connection, the router always looks for the "nearest" public 6to4 relay. This is done using the anycast address 192.88.99.1. This aspect is an advantage of 6to4 tunneling on the one hand, but it also presents a disadvantage on the other. Public 6to4 relays do not require registration and are freely accessible. What's more, the dynamic connection is easily configured. In this way it is possible for any user to create a 6to4 tunnel over a public relay, quickly and easily.

On the other hand, the dynamic connection means that the user has no influence on the choice of the 6to4 relay. The provider of the relay is able to intercept or manipulate data.

## 9.3 DHCPv6

Compared to IPv4, clients in an IPv6 network do not require automatic address assignment from a DHCP server because they use auto-configuration. However, because certain information such as DNS server addresses are not transmitted during auto-configuration, certain application scenarios can benefit from a DHCP service on the IPv6 network.

### 9.3.1 DHCPv6 server

The use of a DHCPv6 server is optional for IPv6. In principle, a DHCPv6 server supports two modes:

- **Stateless:** The DHCPv6 server does not distribute addresses but only information, such as DNS server addresses. Using this method, clients generate their own IPv6 addresses by 'stateless address auto-configuration (SLAAC)'. This method is particularly attractive for example for small networks in order to keep administration efforts to a minimum.
- **Stateful:** The DHCPv6 server distributes IPv6 addresses, similar to IPv4. This method is more complicated, since a DHCPv6 server has to assign and manage the addresses.

A DHCPv6 server distributes only the options that are explicitly requested by an IPv6 client, i. e. the server only assigns an address to a client if it explicitly requests one.

Additionally, the DHCPv6 server can pass on prefixes to routers for further distribution. This method is referred to as 'prefix delegation'. A DHCPv6 client must have explicitly requested this prefix, however.

### 9.3.2 DHCPv6 client

The auto-configuration available with IPv6 networks makes it very easy and convenient to configure the clients.

However, in order for a client to receive additional information, such as a DNS server address, you must configure the device so that it can activate the DHCPv6 client when necessary.

The settings for the DHCPv6 client ensure that a device receiving certain flags in the router advertisement will start the DHCPv6 client, which can then send requests to the DHCPv6 server:

- **M flag:** If an appropriately configured device receives a router advertisement with the 'M flag' set, the DHCPv6 client will request an IPv6 address from the DHCPv6 server along with other information such as DNS server, SIP server and NTP server.
- **O flag:** With an 'O flag', the DHCPv6 client requests the DHCPv6 server for information such as a DNS server, SIP server and NTP server only, but not an IPv6 address.



If the 'M-flag' is set, the 'O-flag' does not necessarily have to be set as well.



With IPv6, the default route is distributed via router advertisements and not via DHCPv6.

## 9.4 IPv4 VPN tunnel via IPv6

Until now it was not possible to set up a VPN between two remote stations using private IPv4 addresses to access the Internet (e. g. 3G/4G networking).



This restriction no longer exists with IPv6, because every IPv6 device receives a public IPv6 address. Thus IPv6 can be used to set up an IPv4 VPN tunnel to interconnect two remote IPv4 networks, regardless of the IPv4 WAN addresses used at each site.

In the example shown, two local IPv4 networks are connected via an IPv4 VPN tunnel, which is established over an IPv6 Internet connection. The IPv4 VPN packets are given IPv6 headers and sent to the remote site via the IPv6 Internet connection (either native or via tunnel broker).

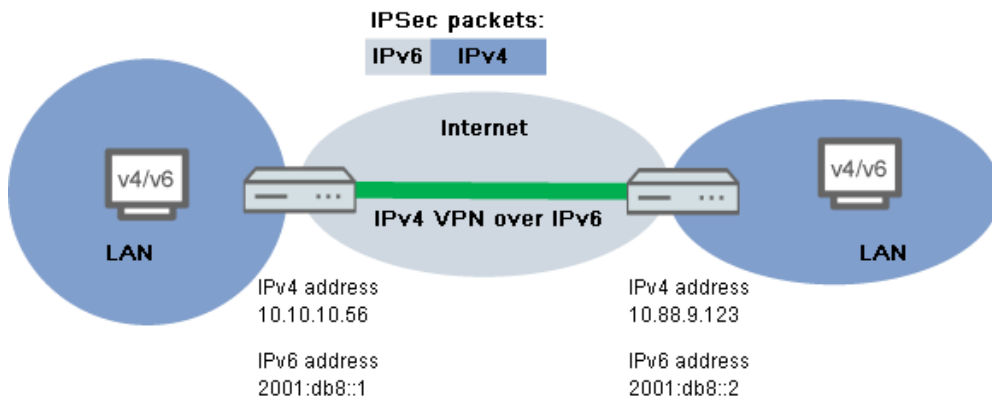

### 9.4.1 Setup Wizard – Setting up an IPv4 VPN connection via IPv6

The Setup Wizard option "Connect two local area networks" helps you to set up a VPN connection.

1. Start LANconfig, for example from the Windows start menu with **Start > Programs > LANCOM > LANconfig**. LANconfig now automatically searches the local network for devices. As soon as LANconfig has completed its search, it presents a list of all the devices it found, if possible with a brief description, the IP address and the status.
2. Choose your device from the selection window in LANconfig and select the **Setup Wizard** button or use the menu under **Tools > Setup Wizard**. LANconfig first reads out the device configuration and then displays the selection window with the optional applications.
3. Launch the action **Connect two local area networks**.
4. Follow the Wizard's instructions and enter the necessary data.
5. As the gateway address, enter the IPv6 address of the gateway.

Setup Wizard for New Configuration for LANCOM 1781AW - V8.80 D2012-11-22 ...

**Connect two local area networks (VPN)**  
 Settings for the TCP/IP protocol

Enter the IP address or the DNS name (FQDN) of the remote gateway for this VPN connection by that the remote site can be reached by the Internet.

Gateway:

Please enter the address of the remote IP network. The router will then be able to transmit data to this network automatically.

Address:   
 Netmask:

You can specify a domain expression which you can use to connect to special stations at the remote site by using the fully qualified domain names (FQDN).

DNS Forwarding:

< Back    Next >    Cancel

6. You can then close the Wizard with **Finish**. The Setup Wizard writes the configuration to the device.

## 9.5 IPv6 firewall

### 9.5.1 Function

While the IPv4 firewall only controls the forwarding of IP data, the IPv6 firewall also regulates the functions of the access lists for all IPv6 server services. Therefore, the IPv6 firewall is similar to a classic firewall design, which separately supports the inbound and outbound communications, as well as forwarding. Since the LANCOM configuration specifically controls communication, LCOS does not require an outbound firewall.

### 9.5.2 Configuration

The configuration of the IPv6 firewall is practically the same as the IPv4 firewall; however, it is performed separately.

The inbound and forwarding firewalls each have their own rule tables, which are similar in scope and structure to the IPv4 firewall.

The rules are sorted with decreasing priority, i. e. the rule with the highest priority is at the top of the list. Rules of the same priority are sorted by their precision, analogous to the IPv4 procedure. If a rule requires further actions, these are also performed by firewall in sequence. Otherwise, firewall filtering is terminated after the current rule has been applied.

### 9.5.3 Default entries for the IPv6 firewall rules

By default, IPv6 firewall has a number of filter rules that are applied on incoming data streams.

#### Default entries for the inbound rules

This table contains the rules that the firewall will apply to inbound connections. The factory settings provide the following rules for the most important applications:

- **ALLOW-ICMP, ACCEPT:** Allow all connections using ICMPV6.
- **ALLOW-DHCP-CLIENT, ACCEPT:** Allow communication with the DHCPv6 client.
- **ALLOW-VPN-CONFIG, ACCEPT-VPN:** Allow VPN communication via HTTP, HTTPS, SNMP, SSH, TELNET, and TFTP.
- **ALLOW-DNS-SERVER-VPN, ACCEPT-VPN:** Allow VPN communication with the internal DNS server.
- **DENY-ALL, REJECT-SNMP:** Block all communication via SNMP.
- **ALLOW-CONFIG-LOCALNET, ACCEPT:** Allow configuration in the local network via HTTP, HTTPS, SNMP, SSH, TELNET, TFTP.
- **ALLOW-CONFIG-WAN, ACCEPT:** Allow communication via the WAN interface via HTTPS, SSH.
- **ALLOW-DHCP-SERVER, ACCEPT:** Allow communication with the DHCPv6 server.
- **ALLOW-DNS-SERVER, ACCEPT:** Allow unsecured communication with the internal DNS server.
- **ALLOW-IPSEC, ACCEPT:** Allow all VPN communication over IPsec.
- **ALLOW-IPSEC-HTTPS-ENCAPSULATION, ACCEPT:** Allow all VPN communication with HTTPS over IPsec.

#### Default entries for the forwarding rules

This table contains the rules that the firewall will apply for forwarding data. The factory settings provide the following rules for the most important applications:

- **ALLOW-VPN, ACCEPT-VPN:** Allow all connections using IPsec.
- **DENY-ALL, REJECT-SNMP:** Block all communication via SNMP.
- **ALLOW-OUTBOUND, ACCEPT-VPN:** Allow all outbound communication.

### 9.5.4 IPv6 firewall log table

Similar to the IPv4 firewall, the IPv6 firewall provides a log table of events in the IPv6 environment.

The syntax of the log table is the same as the IPv4 log table with the exception of the IP address format (IPv6 addresses are in hexadecimal format, IPv4 in decimal format).

## Analyzing the IPv6 firewall log table with WEBconfig

You can open IPv6 log tables in WEBconfig with **LCOS menu tree > Status > IPv6 > Firewall > Log table.**

LCOS Menu Tree

- Status
- IPv6
  - Firewall

### Log-Table

Idx.	System-time	Src-Address	Dst-Address	Prot.	Src-Port	Dst-Port	Filter-Rule	Limit	Threshold	Action
<no entries>										

Update

Monitor this Table Update Interval (s): 5

The items have the following meanings:

- **Idx.:** Consecutive index. Furthermore, the table can also be checked via SNMP.
- **System time:** System time in UTC encoding (converted to plain text for display).
- **Source addresses:** Source address of the filtered packets.
- **Destination addresses:** Destination address of the filtered packets.
- **Prot.:** Protocol (TCP, UDP, etc.) of the filtered packets.
- **Source port:** Source port of the filtered packet (only for port related protocols).
- **Destination port:** Destination port of the filtered packet (only for port related protocols).
- **Filter rule:** Name of the rule that created the entry.
- **Limit:** Bit field that contains the description of the limit that caused the firewall to apply the filter. There following values are currently defined:
  - 0x01: Absolute number
  - 0x02: Number per second
  - 0x04: Number per minute
  - 0x08: Number per hour:
  - 0X10: Global limit
  - 0x20: Byte limit (if not set, it is a packet limit)
  - 0x40: Limit only applies in the inbound direction
  - 0x80: Limit only applies in the outbound direction
- **Threshold:** Threshold limit value of the triggering limit.
- **Action:** Bit field which lists all the actions performed. There following values are currently defined:
  - 0x00000001: Accept
  - 0x00000100: Reject
  - 0x00000200: Establish filter
  - 0x00000400: Internet (default router) filter
  - 0x00000800: Drop
  - 0x00001000: Disconnect
  - 0x00004000: Lock source address

- 0x00020000: Lock destination address and port
- 0X20000000: Send SYSLOG notification message
- 0x40000000: Send SNMP trap
- 0x80000000: Send e-mail

! All firewall actions also appear in the IP router trace .

## Analyzing the IPv6 firewall log table with LANmonitor

You can view the IPv6 log for a specific device in the LANmonitor.

To do this, start the LANmonitor with **Start > Programs > LANCOM > LANmonitor**. You can also launch the LANmonitor for a specific device with the context menu in LANconfig or with the keyboard shortcut `Ctrl + M`.

Via **Device > View firewall event log** you can view the firewall events for a selected device. The firewall events show the last 100 actions of the firewall with the following details:

- Idx
- Time
- Source address
- Destination address
- Protocol
- Source port
- Destination port
- Firewall rule
- Limit
- Action

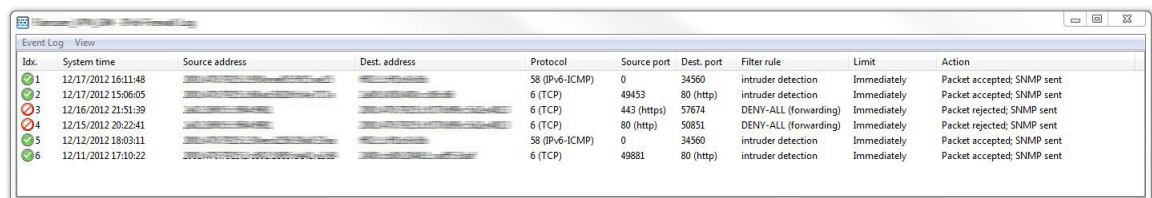

Idx.	System time	Source address	Dest. address	Protocol	Source port	Dest. port	Filter rule	Limit	Action
1	12/17/2012 16:11:48			58 (IPv6-ICMP)	0	34560	intruder detection	Immediately	Packet accepted; SNMP sent
2	12/17/2012 15:06:05			6 (TCP)	49453	80 (http)	intruder detection	Immediately	Packet accepted; SNMP sent
3	12/16/2012 21:51:39			6 (TCP)	443 (https)	57674	DENY-ALL (forwarding)	Immediately	Packet rejected; SNMP sent
4	12/15/2012 20:22:41			6 (TCP)	80 (http)	50851	DENY-ALL (forwarding)	Immediately	Packet rejected; SNMP sent
5	12/12/2012 18:03:11			58 (IPv6-ICMP)	0	34560	intruder detection	Immediately	Packet accepted; SNMP sent
6	12/11/2012 17:10:22			6 (TCP)	49881	80 (http)	intruder detection	Immediately	Packet accepted; SNMP sent

## 9.6 Additions to the Setup menu

### 9.6.1 Tunnel

Use this setting to manage the tunneling protocols to provide access to the IPv6 Internet via an IPv4 Internet connection.

**SNMP ID:**

2.70.1

**Telnet path:**

**Setup > IPv6 > Tunnel**

#### 6in4

The table contains the settings for the 6in4 tunnel.

**SNMP ID:**

2.70.1.1

**Telnet path:****Setup > IPv6 > Tunnel > 6in4****Peer name**

Contains the name of the 6in4 tunnel.

**SNMP ID:**

2.70.1.1.1

**Telnet path:****Setup > IPv6 > Tunnel > 6in4 > Peer-Name****Possible values:**

Max. 16 characters

**Default:**

Blank

**Routing tag**

The interface tag that you enter here is a value that uniquely identifies the network. All packets received by this device on this network will be internally marked with this tag. The interface tag enables the routes which are valid for this network to be separated even without explicit firewall rules.

**SNMP ID:**

2.70.1.1.2

**Telnet path:****Setup > IPv6 > Tunnel > 6in4 > Rtg-Tag****Possible values:**

Max. 5 characters in the range 0 – 65534

**Default:**

0

**Gateway address**

Contains the IPv4 address of the remote 6in4 gateway.

---

 The 6in4 tunnel is only set up if the gateway can be reached by ping at this address.

**SNMP ID:**

2.70.1.1.3

**Telnet path:****Setup > IPv6 > Tunnel > 6in4 > Gateway-Address****Possible values:**

IP address in IPv4 notation, max. 64 characters

**Default:**

Blank

**IPv4 routing tag**

Here you define the routing tag that the device uses to determine the route to the associated remote gateway. The IPv4 routing tag specifies which tagged IPv4 route is to be used for the data packets to reach their destination address. The following destination addresses can be entered:

- 6to4 anycast address
- 6in4 gateway address
- 6rd border relay address

**SNMP ID:**

2.70.1.1.4

**Telnet path:****Setup > IPv6 > Tunnel > 6in4 > IPv4-Rtg-tag****Possible values:**

Max. 5 characters in the range 0 – 65534

**Default:**

0

**Gateway IPv6 address**

Contains the IPv6 address of the remote tunnel endpoint on the intermediate network, for example, "2001:db8::1".

**SNMP ID:**

2.70.1.1.5

**Telnet path:****Setup > IPv6 > Tunnel > 6in4 > Gateway-IPv6-Address****Possible values:**

IPv6 address with max. 43 characters

**Default:**

Blank

**Local-IPv6-Address**

Contains the local IPv6 address of the device on the intermediate network, for example "2001:db8::2/64".

**SNMP ID:**

2.70.1.1.6

**Telnet path:****Setup > IPv6 > Tunnel > 6in4 > Local-IPv6-Address****Possible values:**

Max. 43 characters

**Default:**

Blank

**Routed IPv6 prefix**

Contains the prefix that is routed from the remote gateway to the local device and that is to be used in LAN, e. g. "2001:db8:1:1::/64" or "2001:db8:1::/48".

**SNMP ID:**

2.70.1.1.7

**Telnet path:****Setup > IPv6 > Tunnel > 6in4 > Routed-IPv6-Prefix****Possible values:**

Max. 43 characters

**Default:**

Blank

**Firewall**

If the global firewall is enabled for IPv6 interfaces, you can disable the firewall for an individual tunnel interface here. To enable the firewall globally for all interfaces, select **IPv6 firewall/QoS enabled** in the menu **Firewall/QoS > General**.



Disabling the firewall globally means that the firewall is disabled for all interfaces, even if you enable this option.

**SNMP ID:**

2.70.1.1.8

**Telnet path:****Setup > IPv6 > Tunnel > 6in4 > Firewall****Possible values:**

Yes

No

**Default:**

Yes

**6rd border relay**

A LANCOM router can operate as a 6rd client or as a 6rd border relay. A 6rd client or 6rd CE router (customer edge router) connects to an Internet service provider via a WAN connection and propagates the 6rd prefix to clients on the LAN. A 6rd border relay operates in the provider's network and connects 6rd clients to the IPv6 network. Thus a 6rd border relay used when an IPv6 connection is to be provided to 6rd routers.

**SNMP ID:**

2.70.1.2

**Telnet path:****Setup > IPv6 > Tunnel > 6rd-Border-Relay****Peer name**

Contains the name of the 6rd border relay tunnel.

**SNMP ID:**

2.70.1.2.1

**Telnet path:****Setup > IPv6 > Tunnel > 6rd-Border-Relay > Peer-Name**

**Possible values:**

Max. 16 characters

**Default:**

Blank

**Routing tag**

The interface tag that you enter here is a value that uniquely identifies the network. All packets received by this device on this network will be internally marked with this tag. The interface tag enables the routes which are valid for this network to be separated even without explicit firewall rules.

**SNMP ID:**

2.70.1.2.2

**Telnet path:**

**Setup > IPv6 > Tunnel > 6rd-Border-Relay > Rtg-Tag**

**Possible values:**

Max. 5 characters in the range 0 – 65534

**Default:**

0

**IPv4 loopback address**

Set the IPv4 loopback address, i.e. the address where the device operates as a 6rd border relay.

**SNMP ID:**

2.70.1.2.3

**Telnet path:**

**Setup > IPv6 > Tunnel > 6rd-Border-Relay > IPv4-Loopback-Address**

**Possible values:**

Max. 16 characters

**Default:**

Blank

**6rd prefix**

Defines the prefix used by this border relay for the 6rd domain, e. g. 2001:db8:/32. This prefix must also be configured on all associated 6rd clients.

**SNMP ID:**

2.70.1.2.4

**Telnet path:**

**Setup > IPv6 > Tunnel > 6rd-Border-Relay > 6rd-Prefix**

**Possible values:**

Max. 24 characters as a prefix of an IPv6 address with up to four blocks of four hexadecimal digits each

**Default:**

Blank



**IPv4 mask length**

Defines the number of significant bits of IPv4 addresses that are identical within a 6rd domain. With mask length "0" there are no identical bits. In this case, the entire IPv4 address is used to generate the delegated 6rd prefix.

The provider sets the mask length.

**Example:** The IPv4 address of the device is "192.168.1.99" (in hexadecimal: "c0a8:163"). In this case, the following are examples of possible combinations:

6rd domain	Mask length	6rd prefix
2001:db8::/32	0	2001:db8:c0a8:163::/64
2001:db8:2::/48	16	2001:db8:2:163::/64
2001:db8:2:3300::/56	24	2001:db8:2:3363::/64

**SNMP ID:**

2.70)

**Telnet path:**

**Setup > IPv6 > Tunnel > 6rd-Border-Relay > IPv4-Mask-Length**

**Possible values:**

Max. 2 numbers in the range 0 – 32

**Default:**

0: The device uses the full IPv4 address.

**DHCPv4 propagate**

If you enable this function, the 6rd border relay distributes the prefix via DHCPv4 if the DHCPv4 client requests it.

 If you do not enable this feature, you must manually configure the required 6rd settings for the 6rd clients.

**SNMP ID:**

2.70.1.2.6

**Telnet path:**

**Setup > IPv6 > Tunnel > 6rd-Border-Relay > DHCPv4-Propagate**

**Possible values:**

Yes

No

**Default:**

No

**Firewall**

If the global firewall is enabled for IPv6 interfaces, you can disable the firewall for an individual tunnel interface here. To enable the firewall globally for all interfaces, select **IPv6 firewall/QoS enabled** in the menu **Firewall/QoS > General**.

 Disabling the firewall globally means that the firewall is disabled for all interfaces, even if you enable this option.

**SNMP ID:**

2.70.1.2.7

**Telnet path:**

**Setup > IPv6 > Tunnel > 6rd-Border-Relay > Firewall**

**Possible values:**

Yes

No

**Default:**

Yes

**6rd**

The table contains the settings for the 6rd tunnel.

**SNMP ID:**

2.70.1.3

**Telnet path:**

**Setup > IPv6 > Tunnel > 6rd**

**Peer name**

Contains the name of the 6rd tunnel.

**SNMP ID:**

2.70.1.3.1

**Telnet path:**

**Setup > IPv6 > Tunnel > 6rd > Peer-Name**

**Possible values:**

Max. 16 characters

**Default:**

Blank

**Routing tag**

The interface tag that you enter here is a value that uniquely identifies the network. All packets received by this device on this network will be internally marked with this tag. The interface tag enables the routes which are valid for this network to be separated even without explicit firewall rules.

**SNMP ID:**

2.70.1.3.2

**Telnet path:**

**Setup > IPv6 > Tunnel > 6rd > Rtg-Tag**

**Possible values:**

Max. 5 characters in the range 0 – 65534

**Default:**

0

**Border relay address**

Contains the IPv4 address of the 6rd border relay.

**SNMP ID:**

2.70.1.3.3

**Telnet path:****Setup > IPv6 > Tunnel > 6rd4 > Border-Relay-Address****Possible values:**

IPv4 address with max. 64 characters

**Default:**

Blank

**IPv4 routing tag**

Here you define the routing tag that the device uses to determine the route to the associated remote gateway. The IPv4 routing tag specifies which tagged IPv4 route is to be used for the data packets to reach their destination address. The following destination addresses can be entered:

- 6to4 anycast address
- 6in4 gateway address
- 6rd border relay address

**SNMP ID:**

2.70.1.3.4

**Telnet path:****Setup > IPv6 > Tunnel > 6rd > IPv4-Rtg-tag****Possible values:**

Max. 5 characters in the range 0 – 65534

**Default:**

0

**6rd prefix**

Contains the prefix used by the provider for 6rd services, e. g. 2001:db8::/32.



If the 6rd prefix is assigned through DHCPv4, you have to enter "::/32" here.

**SNMP ID:**

2.70.1.3.5

**Telnet path:****Setup > IPv6 > Tunnel > 6rd > 6rd-Prefix****Possible values:**

Max. 24 characters

**Default:**

Blank

**IPv4 mask length**

Defines the number of significant bits of IPv4 addresses that are identical within a 6rd domain. With mask length "0" there are no identical bits. In this case, the entire IPv4 address is used to generate the delegated 6rd prefix.

The provider sets the mask length.

**Example:** The IPv4 address of the device is "192.168.1.99" (in hexadecimal: "c0a8:163"). In this case, the following are examples of possible combinations:

6rd domain	Mask length	6rd prefix
2001:db8::/32	0	2001:db8:c0a8:163::/64
2001:db8:2::/48	16	2001:db8:2:163::/64
2001:db8:2:3300::/56	24	2001:db8:2:3363::/64

**SNMP ID:**

2.70.1.3.6

**Telnet path:****Setup > IPv6 > Tunnel > 6rd > IPv4-Mask-Length****Possible values:**

Max. 2 numbers in the range 0 – 32

**Default:**

0

**Firewall**

If the global firewall is enabled for IPv6 interfaces, you can disable the firewall for an individual tunnel interface here. To enable the firewall globally for all interfaces, select **IPv6 firewall/QoS enabled** in the menu **Firewall/QoS > General**.

 Disabling the firewall globally means that the firewall is disabled for all interfaces, even if you enable this option.

**SNMP ID:**

2.70.1.3.7

**Telnet path:****Setup > IPv6 > Tunnel > 6rd4 > Firewall****Possible values:**

Yes

No

**Default:**

Yes

**6to4**

The table contains the settings for the 6to4 tunnel.

 Connections through a 6to4 tunnel work with relays that are selected by the IPv4 Internet provider's backbone. The device administrator has no influence on relay selection. Furthermore, the selected relay can change without the administrator knowing about it. For this reason, connections via a 6to4 tunnels are suitable **for test purposes only**. In particular, avoid using 6to4-tunnel data connections for productive systems or for the transmission of confidential data.

**SNMP ID:**

2.70.1.4

**Telnet path:**

**Setup > IPv6 > Tunnel > 6to4**

**Peer name**

Contains the name of the 6to4 tunnel.

**SNMP ID:**

2.70.1.4.1

**Telnet path:**

**Setup > IPv6 > Tunnel > 6to4 > Peer-Name**

**Possible values:**

Max. 16 characters

**Default:**

Blank

**Routing tag**

The interface tag that you enter here is a value that uniquely identifies the network. All packets received by this device on this network will be internally marked with this tag. The interface tag enables the routes which are valid for this network to be separated even without explicit firewall rules.

**SNMP ID:**

2.70.1.4.2

**Telnet path:**

**Setup > IPv6 > Tunnel > 6to4 > Rtg-Tag**

**Possible values:**

Max. 5 characters in the range 0 – 65535

**Default:**

0

**Gateway address**

Contains the IPv4 address of the 6to4 relay or 6to4 gateway. Default value is the anycast address "192.88.99.1". In general, you can leave this address unchanged as it will always give you access to the closest 6to4 relay on the Internet.

---

 The 6to4 tunnel is only set up if the gateway can be reached by ping at this address.

**SNMP ID:**

2.70.1.4.3

**Telnet path:**

**Setup > IPv6 > Tunnel > 6to4 > Gateway-Address**

**Possible values:**

IPv4 address with max. 64 characters

**Default:**

192.88.99.1

**IPv4 routing tag**

Here you define the routing tag that the device uses to determine the route to the associated remote gateway. The IPv4 routing tag specifies which tagged IPv4 route is to be used for the data packets to reach their destination address. The following destination addresses can be entered:

- 6to4 anycast address
- 6in4 gateway address
- 6rd border relay address

**SNMP ID:**

2.70.1.4.4

**Telnet path:****Setup > IPv6 > Tunnel > 6to4 > IPv4-Rtg-tag****Possible values:**

Max. 5 characters in the range 0 – 65534

**Default:**

0

**Firewall**

If the global firewall is enabled for IPv6 interfaces, you can disable the firewall for an individual tunnel interface here. To enable the firewall globally for all interfaces, select **IPv6 firewall/QoS enabled** in the menu **Firewall/QoS > General**.



Disabling the firewall globally means that the firewall is disabled for all interfaces, even if you enable this option.

**SNMP ID:**

2.70.1.4.5

**Telnet path:****Setup > IPv6 > Tunnel > 6to4 > Firewall****Possible values:**

Yes

No

**Default:**

Yes

## 9.6.2 Router advertisement

These settings are used to manage the router advertisements, which are used to announce the device's availability as a router to the network.

**SNMP ID:**

2.70.2

**Telnet path:****Setup > IPv6 > Router-Advertisement****Prefix options**

The table contains the settings for IPv6 prefixes for each interface.

**SNMP ID:**

2.70.2.1

**Telnet path:****Setup > IPv6 > Router-Advertisement > Prefix-Options****Interface name**

Defines the name of the logical interface.

**SNMP ID:**

2.70.2.1.1

**Telnet path:****Setup > IPv6 > Router-Advertisements > Prefix-Options > Interface-Name****Possible values:**

Max. 16 characters

**Default:**

Blank

**Prefix**

Enter the prefix that is transmitted with the router advertisements, e. g. "2001:db8::/64".

The length of the prefix must always be exactly 64 bits ("/64"), or else the clients will not be able to generate their own addresses by adding their "interface identifier" (64 bits long).

If you wish to automatically use the prefix issued by the provider, then configure "::/64" here and enter the name of the corresponding WAN interface in the field **PD-Source**.**SNMP ID:**

2.70.2.1.2

**Telnet path:****Setup > IPv6 > Router-Advertisements > Prefix-Options > Prefix****Possible values:**

Max. 43 characters

**Default:**

Blank

**Subnet ID**

Here you set the subnet ID that is to be combined with the prefix issued by the provider.

If the provider assigns the prefix "2001:db8:a::/48", for example, and you assign the subnet ID "0001" (or "1" for short), then the router advertisement on this interface is given the prefix "2001:db8:a:0001::/64".

The maximum subnet length with a 48-bit long, delegated prefix is 16 bits (65,536 subnets of "0000" to "FFFF"). With a delegated prefix of "/56", the maximum subnet length is 8 bits (256 subnets of "00" to "FF").



In general, the subnet ID "0" is used when the WAN IPv6 address is compiled automatically. For this reason you should start with "1" when assigning subnet IDs for LANs.

**SNMP ID:**

2.70.2.1.3

**Telnet path:**

**Setup > IPv6 > Router-Advertisements > Prefix-Options > Subnet-ID**

**Possible values:**

Max. 19 characters

**Default:**

1

**Adv.-OnLink**

Indicates whether the prefix is "on link".

**SNMP ID:**

2.70.2.1.3

**Telnet path:**

**Setup > IPv6 > Router-Advertisements > Prefix-Options > Adv.-OnLink**

**Possible values:**

Yes

No

**Default:**

Yes

**Adv.-Autonomous**

Indicates whether a host can use the prefix for a "Stateless Address Autoconfiguration". If this is the case, it can connect directly to the Internet.

**SNMP ID:**

2.70.2.1.5

**Telnet path:**

**Setup > IPv6 > Router-Advertisements > Prefix-Options > Adv.-Autonomous**

**Possible values:**

Yes

No

**Default:**

Yes

**PD source**

Use the name of the interface that receives a prefix issued by the provider. This prefix is combined with the string entered in the field **Prefix** to form a subnet that announces router advertisements (DHCPv6 prefix delegation).

**SNMP ID:**

2.70.2.1.6

**Telnet path:**

**Setup > IPv6 > Router-Advertisements > Prefix-Options > PD-Source**

**Possible values:**

Max. 16 characters



**Default:**

Blank

**Advertise preferred lifetime**

Defines the time in milliseconds for which an IPv6 address is to be "Preferred". The client also uses this lifetime for its generated IPv6 address. If the lifetime of the prefix has expired, the client no longer uses the corresponding IPv6 address. If the "preferred lifetime" of an address expires, it will be marked as "deprecated". This address is then used only by already active connections until those connections end. Expired addresses are no longer available for new connections.

**SNMP ID:**

2.70.2.1.7

**Telnet path:****Setup > IPv6 > Router-Advertisements > Prefix-Options > Adv.-Pref.-Lifetime****Possible values:**

Max. 10 numbers in the range 0 – 2147483647

**Default:**

604800

**Adv.-Valid-Lifetime**

Defines the time in seconds, after which the validity of an IPv6 address expires. Expired addresses are no longer available for new connections.

**SNMP ID:**

2.70.2.1.8

**Telnet path:****Setup > IPv6 > Router-Advertisements > Prefix-Options > Adv.-Valid-Lifetime****Possible values:**

Max. 10 numbers in the range 0 – 2147483647

**Default:**

2592000

**Decrement lifetimes**

If this option is enabled, the preferred and valid lifetime of the prefix in the router advertisements are automatically counted down over time or extended. The preferred and valid lifetimes of the prefix in the router advertisements are synchronized with the times from the delegated prefix as retrieved from the WAN. If the prefix from the provider is not updated, then the preferred and valid lifetimes are counted down to 0, and thus expire. As soon as the device updates the lifetimes of the delegated prefix from the WAN, then the prefix in the router advertisements is extended again. If this option is disabled, the preferred and valid lifetime from the delegated prefix are applied statically, but they are not reduced or extended. This parameter has no effect on tunneled WAN connections (6to4, 6in4 and 6rd), because in this case the prefixes are not retrieved by DHCPv6 prefix delegation, and thus they have no lifetimes. Here, the statically-configured preferred and valid lifetimes from the prefix are applied. This parameter also has no effect if the value for PD source is left empty, because in this case there is no synchronization with the delegated WAN prefix.

**SNMP ID:**

2.70.2.1.10

**Telnet path:****Setup > IPv6 > Router-Advertisement > Prefix-Options**

**Possible values:**

Yes

No

**Default:**

Yes

**Interface options**

The table contains the settings for the IPv6 interfaces.

**SNMP ID:**

2.70.2.2

**Telnet path:****Setup > IPv6 > Router-Advertisements > Interface-Options****Interface name**

Defines the name of the logical interface to be used for sending router advertisements.

**SNMP ID:**

2.70.2.2.1

**Telnet path:****Setup > IPv6 > Router-Advertisements > Interface-Options > Interface-Name****Possible values:**

Max. 16 characters

**Default:**

Blank

**Send adverts**

Enables the periodic transmission of router advertisements and the response to router solicitations.

**SNMP ID:**

2.70.2.2.2

**Telnet path:****Setup > IPv6 > Router-Advertisement > Interface-Options > Send-Adverts****Possible values:**

Yes

No

**Default:**

Yes

**Min. RTR interval**

Defines in seconds the minimum time allowed between the transmission of consecutive unsolicited multicast router advertisements. **Min-RTR-Interval** and **Max-RTR-Interval** form a time space within which the device sends a router advertisement at random.

**SNMP ID:**

2.70.2.2.3

**Telnet path:****Setup > IPv6 > Router-Advertisements > Interface-Options > Min-RTR-Interval****Possible values:**

Min. 3 seconds

Max.  $0.75 * \text{Max-RTR-Interval}$ 

Max. 10 numbers

**Default:** $0.33 * \text{Max-RTR-Interval}$  (if **Max-RTR-Interval**  $\geq$  9 seconds)**Max-RTR-Interval** (if **Max-RTR-Interval**  $<$  9 seconds)**Max. RTR interval**

Defines in seconds the maximum time allowed between the transmission of consecutive unsolicited multicast router advertisements. **Min-RTR-Interval** and **Max-RTR-Interval** form a time space within which the device sends a router advertisement at random.

**SNMP ID:**

2.70.2.2.4

**Telnet path:****Setup > IPv6 > Router-Advertisements > Interface-Options > Max-RTR-Interval****Possible values:**

Min. 4 seconds

Max. 1800 seconds

Max. 10 numbers

**Default:**

600 seconds

**Managed flag**

Sets the "Managed address configuration" flag in the router advertisement.

Setting this flag causes the clients to configure all addresses via "Stateful Autoconfiguration" (DHCPv6). In this case the clients also automatically retrieve other information, such as DNS server addresses.

**SNMP ID:**

2.70.2.2.5

**Telnet path:****Setup > IPv6 > Router-Advertisements > Interface-Options > Managed-Flag****Possible values:**

Yes

No

**Default:**

No

**Other config flag**

Sets the "Other configuration" flag in the router advertisement.

If this flag is set, the device instructs the clients to retrieve additional information (but not the addresses for the client) such as DNS server addresses via DHCPv6.

**SNMP ID:**

2.70.2.2.6

**Telnet path:**

**Setup > IPv6 > Router-Advertisements > Interface-Options > Other-Config-Flag**

**Possible values:**

Yes

No

**Default:**

Yes

**Link MTU**

Here you set the valid MTU for the corresponding link.

**SNMP ID:**

2.70.2.2.7

**Telnet path:**

**Setup > IPv6 > Router-Advertisements > Interface-Options > Link-MTU**

**Possible values:**

Max. 5 numbers in the range 0 – 99999

**Default:**

1500

**Reachable time**

Specifies the time in seconds for which the router is considered to be reachable.

The default value of "0" means that the router advertisements have no specifications for reachable time.

**SNMP ID:**

2.70.2.2.8

**Telnet path:**

**Setup > IPv6 > Router-Advertisements > Interface-Options > Reachable-Time**

**Possible values:**

Max. 10 numbers in the range 0 – 2147483647

**Default:**

0

**Hop limit**

Defines the maximum number of routers to be used to forward a data packet. One router corresponds to one "hop".

**SNMP ID:**

2.70.2.2.10

**Telnet path:**

**Setup > IPv6 > Router-Advertisements > Interface-Options > Hop-Limit**

**Possible values:**

Max. 5 numbers in the range 0 – 255

**Default:**

0: No hop limit defined

**Default lifetime**

Specifies the time in seconds for which the router is considered to be reachable in the network.

---

 If this value is set to **0**, the operating system will not use this router as the default router.

**SNMP ID:**

2.70.2.2.11

**Telnet path:**

**Setup > IPv6 > Router-Advertisements > Interface-Options > Def.-Lifetime**

**Possible values:**

Max. 10 numbers in the range 0 – 2147483647

**Default:**

1800

**Default router mode**

Defines how the device advertises itself as the default gateway or router.

The settings have the following functions:

- **Auto:** As long as a WAN connection exists, the router sends a positive router lifetime in the router advertisement messages. The result is that a client uses this router as the default gateway. If there is no WAN connection, the router sets the router lifetime to "0". A client then stops using this router as the default gateway. This behavior is compliant with RFC 6204.
- **Always:** The router lifetime is always positive—i. e. greater than "0"—irrespective of the WAN connection status.
- **Never:** The router lifetime is always "0".

**SNMP ID:**

2.70.2.2.12

**Telnet path:**

**Setup > IPv6 > Router-Advertisements > Interface-Options > Default-Router-Mode**

**Possible values:**

Auto

Always

Never

**Default:**

Auto

**Router preference**

Defines the preference of this router. Clients enter this preference into their local routing tables.

**SNMP ID:**

2.70.2.2.13

**Telnet path:**

**Setup > IPv6 > Router-Advertisements > Interface-Options > Router-Preference**

**Possible values:**

Low

Medium

High

**Default:**

Medium

**Route options**

The table contains the settings for the route options.

**SNMP ID:**

2.70.2.3

**Telnet path:**

**Setup > IPv6 > Router-Advertisement > Route-Options**

**Interface name**

Defines the name of the interface that this route option applies to.

**SNMP ID:**

2.70.2.3.1

**Telnet path:**

**Setup > IPv6 > Router-Advertisement > Route-Options > Interface-Name**

**Possible values:**

Max. 16 characters

**Default:**

Blank

**Prefix**

Set the prefix for this route. This should not exceed 64 bits in length if it is to be used for auto-configuration.

**SNMP ID:**

2.70.2.3.2

**Telnet path:**

**Setup > IPv6 > Router-Advertisement > Route-Options > Prefix**

**Possible values:**

IPv6 prefix with max. 43 characters, e.g. 2001:db8::/64

**Default:**

Blank

**Route lifetime**

Set how long in seconds the route should remain valid.

**SNMP ID:**

2.70.2.3.3

**Telnet path:**

**Setup > IPv6 > Router-Advertisement > Route-Options > Route-Lifetime**

**Possible values:**

Max. 5 numbers in the range 0 – 65335

**Default:**

0: No route lifetime specified

**Route preference**

This parameter specifies the priority of an advertised route. A router receiving a router advertisement with two routes of different preference will choose the route with the higher priority.

**SNMP ID:**

2.70.2.3.4

**Telnet path:**

**Setup > IPv6 > Router-Advertisement > Route-Options > Route-Preference**

**Possible values:**

Low

Medium

High

**Default:**

Medium

**RDNSS options**

This table contains the settings of RDNSS extension (recursive DNS server).

---

 This function is not currently supported by Windows. Propagation of a DNS server, where required, is performed via DHCPv6.

**SNMP ID:**

2.70.2.5

**Telnet path:**

**Setup > IPv6 > Router-Advertisements > RDNSS-Options**

**Interface name**

Name of the interface used by the device to announce information about the IPv6 DNS server in router advertisements.

**SNMP ID:**

2.70.2.5.1

**Telnet path:**

**Setup > IPv6 > Router-Advertisements > RDNSS-Options**

**Possible values:**

Max. 16 characters

**Default:**

Blank

**Primary DNS**

IPv6 address of the first IPv6 DNS server (recursive DNS server, RDNSS, according to RFC6106) for this interface.

**SNMP ID:**

2.70.2.5.2

**Telnet path:**

**Setup > IPv6 > Router-Advertisements > RDNSS-Options**

**Possible values:**

Valid IPv6 address

**Default:**

Blank

**Secondary DNS**

IPv6 address of the secondary IPv6 DNS server for this interface.

**SNMP ID:**

2.70.2.5.3

**Telnet path:**

**Setup > IPv6 > Router-Advertisements > RDNSS-Options**

**Possible values:**

Valid IPv6 address

**Default:**

Blank

**DNS search list**

This parameter defines which DNS search list the device propagates on this logical network.

**SNMP ID:**

2.70.2.5.4

**Telnet path:**

**Setup > IPv6 > Router-Advertisements > RDNSS-Options**

**Possible values:**

Internal: If you select this option, the device propagates either the DNS search list from the internal DNS server or the domain of this logical network. The domain is configured under **Setup > DNS > Domain**.

WAN: If you select this option, the device propagates the DNS search list from the provider (e.g. provider-xy.com) for this logical network. This feature is available only if the prefix list is connected to the corresponding WAN interface under **Receive prefix from**.



**Default:**

Internal enabled, WAN disabled.

**Lifetime**

Defines the time in seconds for which a client may use this DNS server for name resolution.

**SNMP ID:**

2.70.2.5.5

**Telnet path:**

**Setup > IPv6 > Router-Advertisements > RDNSS-Options**

**Possible values:**

- Max. 5 numbers in the range 0 – 65535
- 0: Discontinuation

**Default:**

900

## 9.6.3 DHCPv6

This menu contains the DHCPv6 settings.

**SNMP ID:**

2.70.3

**Telnet path:**

**Setup > IPv6 > DHCPv6**

**Server**

This menu contains the DHCP server settings for IPv6.

**SNMP ID:**

2.70.3.1

**Telnet path:**

**Setup > IPv6 > DHCPv6 > Server**

**Address pools**

If distribution of the DHCPv6 server is to be stateful, this table defines an address pool.

**SNMP ID:**

2.70.3.1.2

**Telnet path:**

**Setup > IPv6 > DHCPv6 > Server > Address-Pool**

**Address pool name**

Specify the name of the address pool here.

**SNMP ID:**

2.70.3.1.2.1

**Telnet path:**

**Setup > IPv6 > DHCPv6 > Server > Address-Pools > Address-Pool-Name**

**Possible values:**

Maximum 31 characters

**Default:**

Blank

**Start address pool**

Here you specify the first address in the pool, e. g. "2001:db8::1"

**SNMP ID:**

2.70.3.1.2.2

**Telnet path:**

**Setup > IPv6 > DHCPv6 > Server > Address-Pools > Start-Address-Pool**

**Possible values:**

Maximum 39 characters

**Default:**

Blank

**End address pool**

Here you specify the last address in the pool, e. g. "2001:db8::9"

**SNMP ID:**

2.70.3.1.2.3

**Telnet path:**

**Setup > IPv6 > DHCPv6 > Server > Address-Pools > End-Address-Pool**

**Possible values:**

Maximum 39 characters

**Default:**

Blank

**Preferred lifetime**

Here you specify the time in seconds that the client should treat this address as "preferred". After this time elapses, a client classifies this address as "deprecated".

**SNMP ID:**

2.70.3.1.2.5

**Telnet path:**

**Setup > IPv6 > DHCPv6 > Server > Address-Pools > Pref.-Lifetime**

**Possible values:**

Maximum 10 characters.

**Default:**

3600

**Valid lifetime**

Here you specify the time in seconds that the client should treat this address as "valid".

**SNMP ID:**

2.70.3.1.2.6

**Telnet path:**

**Setup > IPv6 > DHCPv6 > Server > Address-Pools > Valid-Lifetime**

**Possible values:**

Maximum 10 characters.

**Default:**

86400

**PD source**

Name of the WAN interface from which the client should use the prefix to form the address or prefix.

**SNMP ID:**

2.70.3.1.2.7

**Telnet path:**

**Setup > IPv6 > DHCPv6 > Server > Address-Pools**

**Possible values:**

Maximum 16 characters

**Default:**

Blank

**PD pools**

In this table, you specify the prefixes that the DHCPv6 server delegates to other routers.

**SNMP ID:**

2.70.3.1.3

**Telnet path:**

**Setup > IPv6 > DHCPv6 > Server > PD-Pools**

**PD pool name**

Specify the name of the PD pool here.

**SNMP ID:**

2.70.3.1.3.1

**Telnet path:**

**Setup > IPv6 > DHCPv6 > Server > PD-Pools > PD-Pool-Name**

**Possible values:**

Maximum 31 characters

**Default:**

Blank

**Start PD pool**

Here you specify the first prefix for delegation in the PD pool, e. g. "2001:db8:1100::"

**SNMP ID:**

2.70.3.1.3.2

**Telnet path:**

**Setup > IPv6 > DHCPv6 > Server > PD-Pools > Start-PD-Pool**

**Possible values:**

Maximum 39 characters

**Default:**

Blank

**End PD pool**

Here you specify the last prefix for delegation in the PD pool, e. g. "2001:db8:FF00::"

**SNMP ID:**

2.70.3.1.3.3

**Telnet path:**

**Setup > IPv6 > DHCPv6 > Server > PD-Pools > End-PD-Pool**

**Possible values:**

Maximum 39 characters

**Default:**

Blank

**Prefix length**

Here you set the length of the prefixes in the PD pool, e. g. "56" or "60"

**SNMP ID:**

2.70.3.1.3.4

**Telnet path:**

**Setup > IPv6 > DHCPv6 > Server > PD-Pools > Prefix-Length**

**Possible values:**

Maximum 3 characters.

**Default:**

56

**Preferred lifetime**

Here you specify the time in seconds that the client should treat this prefix as "preferred". After this time elapses, a client classifies this address as "deprecated".

**SNMP ID:**

2.70.3.1.3.5

**Telnet path:**

**Setup > IPv6 > DHCPv6 > Server > PD-Pools > Pref.-Lifetime**

**Possible values:**

Maximum 10 characters.

**Default:**

3600

**Valid lifetime**

Here you specify the time in seconds that the client should treat this prefix as "valid".

**SNMP ID:**

2.70.3.1.3.6

**Telnet path:**

**Setup > IPv6 > DHCPv6 > Server > PD-Pools > Valid-Lifetime**

**Possible values:**

Maximum 10 characters.

**Default:**

86400

**PD source**

Name of the WAN interface from which the client should use the prefix to form the address or prefix.

**SNMP ID:**

2.70.3.1.3.7

**Telnet path:**

**Setup > IPv6 > DHCPv6 > Server > PD-Pools**

**Possible values:**

Maximum 16 characters

**Default:**

Blank

**Interface list**

This table is used to configure the basic settings of the DHCPv6 server, and to specify which interfaces they apply to.

**SNMP ID:**

2.70.3.1.4

**Telnet path:**

**Setup > IPv6 > DHCPv6 > Server > Interface-List**

**Interface name or relay**

Name of the interface on which the DHCPv6 server is working, for example "INTRANET"

**SNMP ID:**

2.70.3.1.4.1

**Telnet path:**

**Setup > IPv6 > DHCPv6 > Server > Interface-List > Interface-Name**

**Possible values:**

Selection from the list of LAN interfaces defined in the device; max. 39 characters

**Default:**

Blank

**Active**

Activates or deactivates the DHCPv6 server.

**SNMP ID:**

2.70.3.1.4.2

**Telnet path:**

**Setup > IPv6 > DHCPv6 > Server > Interface-List > Operating**

**Possible values:**

No

Yes

**Default:**

Yes

**Primary DNS**

IPv6 address of the primary DNS server.

**SNMP ID:**

2.70.3.1.4.3

**Telnet path:**

**Setup > IPv6 > DHCPv6 > Server > Interface-List > Primary-DNS**

**Possible values:**

IPv6 address with max. 39 characters

**Default:**

::

**Secondary DNS**

IPv6 address of the secondary DNS server.

**SNMP ID:**

2.70.3.1.4.4

**Telnet path:**

**Setup > IPv6 > DHCPv6 > Server > Interface-List > Secondary-DNS**

**Possible values:**

IPv6 address with max. 39 characters

**Default:**

Blank

**Address pool name**

Here you specify the address pool that the devices uses for this interface.

---

 If the DHCPv6 server operates 'stateful' addresses distribution, you must enter the corresponding addresses into the table **Setup > IPv6 > DHCPv6 > Server > Address-Pools**.

**SNMP ID:**

2.70.3.1.4.5

**Telnet path:****Setup > IPv6 > DHCPv6 > Server > Interface-Liste > Address-Pool-Name****Possible values:**

Maximum 31 characters

**Default:**

Blank

**PD pool name**

Determine the prefix-delegation pool that the devices is to use for this interface.

---

 If the DHCPv6 server is to delegate prefixes to other routers, you must enter the corresponding prefixes in the table **Setup > IPv6 > DHCPv6 > Server > PD-Pools**.

**SNMP ID:**

2.70.3.1.4.6

**Telnet path:****Setup > IPv6 > DHCPv6 > Server > Interface-Liste > PD-Pool-Name****Possible values:**

Maximum 31 characters

**Default:**

Blank

**Rapid commit**

With rapid commit activated, the DHCPv6 server responds directly to a solicit message with a reply message.

---

 The client must explicitly include the rapid commit option in its solicit message.

**SNMP ID:**

2.70.3.1.4.7

**Telnet path:****Setup > IPv6 > DHCPv6 > Server > Interface-Liste > Rapid-Commit****Possible values:**

No

Yes

**Default:**

No

**Preference**

Where multiple DHCPv6 servers are operated on the network, the preference parameter gives you the control over which server the clients will use. The primary server requires a higher preference value than the backup server.

**SNMP ID:**

2.70.3.1.4.8

**Telnet path:****Setup > IPv6 > DHCPv6 > Server > Interface-Liste > Preference****Possible values:**

0 to 255

**Default:**

0

**Renew time**

This specifies the time in seconds when the client should contact the server again (using a renew message) to extend the address/prefix received from the server. The parameter is also called T1.

**SNMP ID:**

2.70.3.1.4.9

**Telnet path:****Setup > IPv6 > DHCPv6 > Server > Interface-List****Possible values:**

0 to 255

**Default:**

0 (automatic)

**Rebind time**

This specifies the time when the client should contact any server (using a rebind message) to extend its delegated address/prefix. The rebind event occurs only if the client receives no answer its renew request. The parameter is also called T2.

**SNMP ID:**

2.70.3.1.4.10

**Telnet path:****Setup > IPv6 > DHCPv6 > Server > Interface-List****Possible values:**

0 to 255

**Default:**

0 (automatic)

**Unicast address**

Unicast address of the DHCP server. The DHCP server uses this address in the server unicast option to allow the client to communicate with to the server via unicast messages. By default, multicast is used.

**SNMP ID:**

2.70.3.1.4.11

**Telnet path:****Setup > IPv6 > DHCPv6 > Server > Interface-List**



**Possible values:**

Valid unicast address

**Default:**

Blank

**DNS search list**

This parameter defines which DNS search list is sent to the clients by the DNS server.

**SNMP ID:**

2.70.3.1.4.12

**Telnet path:**

**Setup > IPv6 > DHCPv6 > Server > Interface-List**

**Possible values:**

None: The DNS server distributes no search lists to the clients.

Internal: Indicates whether the DNS search list or the own domain for this logical network should be inserted from the internal DNS server, e.g., "internal". The own domain can be configured under IPv4 > DNS > General settings.

WAN: Specifies whether the DNS search list sent by the provider (e.g., provider-xy.de) is announced in this logical network. This feature is available only if the prefix list is connected to the corresponding WAN interface under Receive prefix from.

**Default:**

Internal

**Reservations**

If you want to assign fixed IPv6 addresses to clients or fixed prefixes to routers, you can define a reservation for each client in this table.

**SNMP ID:**

2.70.3.1.6

**Telnet path:**

**Setup > IPv6 > DHCPv6 > Server**

**Interface name or relay**

Name of the interface on which the DHCPv6 server is working, for example "INTRANET". Alternatively, you can also enter the IPv6 address of the remote relay agent.

**SNMP ID:**

2.70.3.1.6.1

**Telnet path:**

**Setup > IPv6 > DHCPv6 > Server > Reservations**

**Possible values:**

Selection from the list of LAN interfaces defined in the device; max. 39 characters

**Default:**

Blank

**Address or PD prefix**

IPv6 address or PD prefix that you want to assign statically.

**SNMP ID:**

2.70.3.1.6.2

**Telnet path:**

**Setup > IPv6 > DHCPv6 > Server > Reservations**

**Possible values:**

Maximum 43 characters

**Default:**

Blank

**Client ID**

DHCPv6 unique identifier (DUID) of the client.

DHCPv6 clients are no longer identified with their MAC addresses like DHCPv4 clients, they are identified with their DUID instead. The DUID can be read from the respective client, for example, on Windows with the shell command `ipconfig /all` or in WEBconfig under **Status > IPv6 > DHCPv6 > Client > Client ID**.

For devices working as a DHCPv6 server, the client IDs for clients that are currently using retrieved IPv6 addresses are to be found under **Status > IPv6 > DHCPv6 > Server > Address bindings**, and retrieved IPv6 prefixes are under **Status > IPv6 > DHCPv6 > Server > PD bindings**.

LANmonitor displays that client IDs under **DHCPv6 server**.

**SNMP ID:**

2.70.3.1.6.3

**Telnet path:**

**Setup > IPv6 > DHCPv6 > Server > Reservations**

**Possible values:**

Maximum 96 characters

**Default:**

Blank

**Preferred lifetime**

Here you specify the time in seconds that the client should treat this prefix as "preferred". After this time elapses, a client classifies this address as "deprecated".

**SNMP ID:**

2.70.3.1.6.5

**Telnet path:**

**Setup > IPv6 > DHCPv6 > Server > Reservations**

**Possible values:**

Maximum 10 characters.

**Default:**

3600

**Valid lifetime**

Here you specify the time in seconds that the client should treat this prefix as "valid".



If you use a prefix from a WAN interface for dynamic address formation, you cannot configure values for preferred lifetime and valid lifetime. In this case, the device automatically determines the values that apply to the prefix delegated by the provider.

**SNMP ID:**

2.70.3.1.6.6

**Telnet path:**

**Setup > IPv6 > DHCPv6 > Server > Reservations**

**Possible values:**

Maximum 10 characters.

**Default:**

86400

**PD source**

Name of the WAN interface from which the client should use the prefix to form the address or prefix.

**SNMP ID:**

2.70.3.1.6.7

**Telnet path:**

**Setup > IPv6 > DHCPv6 > Server > Reservations**

**Possible values:**

Maximum 16 characters

**Default:**

Blank

**Client**

This menu contains the DHCP client settings for IPv6.

**SNMP ID:**

2.70.3.2

**Telnet path:**

**Setup > IPv6 > DHCPv6 > Client**

**Interface list**

This table determines the behavior of the DHCPv6 client.



Normally client behavior is controlled by the auto-configuration.

**SNMP ID:**

2.70.3.2.1

**Telnet path:**

**Setup > IPv6 > DHCPv6 > Client > Interface-List**

**Interface name**

Specify the name of the interface that the DHCPv6 client operates on. These may be LAN interfaces or WAN interfaces (remote stations), such as "INTRANET" or "INTERNET".

**SNMP ID:**

2.70.3.2.1.1

**Telnet path:**

**Setup > IPv6 > DHCPv6 > Client > Interface-List > Interface-Name**

**Possible values:**

Selection from the list of LAN interfaces defined in the device; max. 16 characters

**Default:**

Blank

**Operating**

Here you specify if and how the device enables the client. Possible values are:

- **Autoconf:** The device waits for router advertisements, and then starts the DHCPv6 client. This option is the default setting.
- **Yes:** The device starts the DHCPv6 client as soon as the interface is active, without waiting for router advertisements.
- **No:** The DHCPv6 client is disabled on this interface. Even if the device receives router advertisements, it will not start the client.

**SNMP ID:**

2.70.3.2.1.2

**Telnet path:**

**Setup > IPv6 > DHCPv6 > Client > Interface-List > Operating**

**Possible values:**

Autoconf

No

Yes

**Default:**

Autoconf

**Request DNS**

Here you specify whether the client should query the DHCPv6 server for DNS servers.



You must enable this option in order for the device to obtain information about a DNS server.

**SNMP ID:**

2.70.3.2.1.3

**Telnet path:**

**Setup > IPv6 > DHCPv6 > Client > Interface-List > Request-DNS**

**Possible values:**

No

Yes

**Default:**

Yes

**Request address**

Here you specify whether the client should query the DHCPv6 server for an IPv6 address.

 Only activate this option if addresses configured by the DHCPv6 server via this interface are stateful, i. e. not distributed by 'SLAAC'.

**SNMP ID:**

2.70.3.2.1.4

**Telnet path:****Setup > IPv6 > DHCPv6 > Client > Interface-List > Request-Address****Possible values:**

No

Yes

**Default:**

Yes

**Request PD**

Here you specify whether the client should request the DHCPv6 server for an IPv6 prefix. Activating this option is only necessary if the device itself functions as a router and redistributes these prefixes. This option is enabled by default on WAN interfaces in order for the DHCPv6 client to request a prefix from the provider for use in its local network. This option is disabled by default on LAN interfaces because devices in a local network are more likely to function as clients rather than as routers.

**SNMP ID:**

2.70.3.2.1.5

**Telnet path:****Setup > IPv6 > DHCPv6 > Client > Interface-List > Request-PD****Possible values:**

No

Yes

**Default:**

No

**Rapid commit**

When rapid commit is activated, the client attempts to obtain an IPv6 address from the DHCPv6 server with just two messages. If the DHCPv6 server is configured correspondingly, it immediately responds to this solicit message with a reply message.

**SNMP ID:**

2.70.3.2.1.6

**Telnet path:****Setup > IPv6 > DHCPv6 > Client > Interface-List > Rapid-Commit**

**Possible values:**

No  
Yes

**Default:**

Yes

**User class identifier**

This assigns the device a unique user class ID.

A user class identifier is used to identify the type or category of client to the server. For example, the user class identifier can be used to identify all clients of people in the accounting department, or all printers at a specific location.

**SNMP ID:**

2.70.3.2.2

**Telnet path:**

**Setup > IPv6 > DHCPv6 > Client > User-Class-Identifier**

**Possible values:**

Maximum 253 characters

**Default:**

Blank

**Vendor class identifier**

This assigns the device a unique vendor class ID.

The vendor-class-identifier is used to identify the manufacturer of the hardware running the DHCP client.

**SNMP ID:**

2.70.3.2.3

**Telnet path:**

**Setup > IPv6 > DHCPv6 > Client > Vendor-Class-Identifier**

**Possible values:**

Maximum 253 characters

**Default:**

Manufacturer name

**Vendor class number**

Determines the enterprise number that the device manufacturer used to register with the Internet Assigned Numbers Authority (IANA).

**SNMP ID:**

2.70.3.2.4

**Telnet path:**

**Setup > IPv6 > DHCPv6 > Client**

**Possible values:**

Maximum 10 characters

**Default:**

2356

## 9.6.4 Relay agent

This menu contains the DHCP relay agent settings for IPv6.

**SNMP ID:**

2.70.3.3

**Telnet path:****Setup > IPv6 > DHCPv6 > Relay-Agent**

### Interface list

This table determines the behavior of the DHCPv6 relay agent.

**SNMP ID:**

2.70.3.3.1

**Telnet path:****Setup > IPv6 > DHCPv6 > Relay-Agent > Interface-List**

### Interface name

Define the name of the interface on which the relay agent receives requests from DHCPv6 clients, e. g. "INTRANET".

**SNMP ID:**

2.70.3.3.1.1

**Telnet path:****Setup > IPv6 > DHCPv6 > Relay-Agent > Interface-List > Interface-Name****Possible values:**

Selection from the list of LAN interfaces defined in the device; max. 16 characters

**Default:**

Blank

### Relay agent operating

With this option you define if and how the device enables the relay agent.

**SNMP ID:**

2.70.3.3.1.2

**Telnet path:****Setup > IPv6 > DHCPv6 > Relay-Agent > Interface-List > Relay-Agent-Operating****Possible values:**

**Yes:** Relay agent is enabled. This option is the default setting.

**No:** Relay agent is not enabled.

**Default:**

Yes

**Interface address**

Specify the relay agent's own IPv6 address at the interface that is configured under Interface Name. This IPv6 address is used as a sender address in DHCP messages that are forwarded. This sender address enables DHCPv6 clients to uniquely identify a relay agent. An explicit specification of the interface address is necessary because an IPv6 host can have multiple IPv6 addresses for each interface.

**SNMP ID:**

2.70.3.3.1.3

**Telnet path:****Setup > IPv6 > DHCPv6 > Relay-Agent > Interface-List > Interface-Address****Possible values:**

Maximum 39 characters

**Default:**

Blank

**Destination address**

Define the IPv6 address of the (destination) DHCPv6 server which the relay agent is to forward DHCP requests to. The address can be either a unicast or link-local multicast address. When using a link-local multicast address, you must specify the destination interface where the DHCPv6 server is to be reached. All DHCPv6 servers and relay agents are available at the link-local multicast address ff02::1:2.

**SNMP ID:**

2.70.3.3.1.4

**Telnet path:****Setup > IPv6 > DHCPv6 > Relay-Agent > Interface-List > Dest-Address****Possible values:**

Maximum 39 characters

**Default:**

ff02::1:2

**Destination interface**

Here you specify the destination interface where the parent DHCPv6 server or the next relay agent is to be reached. This information is essential if a link-local multicast address is configured under the destination address, as link local-multicast addresses are only valid at that respective link.

**SNMP ID:**

2.70.3.3.1.5

**Telnet path:****Setup > IPv6 > DHCPv6 > Relay-Agent > Interface-List > Dest-Interface****Possible values:**

Maximum 39 characters

**Default:**

Blank

## 9.6.5 Network

Here you can adjust further IPv6 network settings for each logical interface supported by your device.



**SNMP ID:**

2.70.4

**Telnet path:****Setup > IPv6 > Network****Addresses**

This table is used to manage the IPv6 addresses.

**SNMP ID:**

2.70.4.1

**Telnet path:****Setup > IPv6 > Network > Addresses****Interface name**

Give a name to the interface that you want to assign the IPv6 network.

**SNMP ID:**

2.70.4.1.1

**Telnet path:****Setup > IPv6 > Network > Addresses > Interface-Name****Possible values:**

Max. 16 characters

**Default:**

Blank

**IPv6 address prefix length**

Specify an IPv6 address including the prefix length for this interface.



The default prefix length is 64 bits ("/64"). If possible do not use IPv6 addresses with longer prefixes, as many IPv6 mechanisms in the device are designed for a maximum length of 64 bits.

A possible address is, for example, "2001:db8::1/64". An interface can have multiple IPv6 addresses:

- A "global unicast address", e. g. "2001:db8::1/64",
- A "unique local address", e. g. "fd00::1/64".

"Link local addresses" are fixed and not configurable.

**SNMP ID:**

2.70.4.1.2

**Telnet path:****Setup > IPv6 > Network > Addresses > IPv6-Address-Prefixlength****Possible values:**

Max. 43 characters

**Default:**

Blank

**Address type**

Determine the type of IPv6 address.

Using the address type **EUI-64** causes IPv6 addresses to be formed according to the IEEE standard "EUI-64". The MAC address of the interface thus forms a uniquely identifiable part of the IPv6 address. The correct input format for an IPv6 address including the prefix length as per EUI-64 would be: "2001:db8:1::/64".

---

 "EUI-64" ignores any value set as "interface identifier" in the corresponding IPv6 address and replaces it with an "interface identifier" as per "EUI-64".

---

 The prefix length for "EUI-64" must be "/64".

**SNMP ID:**

2.70.4.1.3

**Telnet path:**

**Setup > IPv6 > Network > Addresses > Address-Type**

**Possible values:**

Unicast

Anycast

EUI-64

**Default:**

Unicast

**Name**

Enter a descriptive name for this combination of IPv6 address and prefix.

---

 Entering a name is optional.

**SNMP ID:**

2.70.4.1.4

**Telnet path:**

**Setup > IPv6 > Network > Addresses > Name**

**Possible values:**

Max. 16 characters

**Default:**

Blank

**Comment**

Enter a descriptive comment for this entry.

---

 Entering a comment is optional.

**SNMP ID:**

2.70.4.1.5

**Telnet path:**

**Setup > IPv6 > Network > Addresses > Comment**

**Possible values:**

Max. 64 characters

**Default:**

Blank

**Parameter**

This table is used to manage the IPv6 parameters.

**SNMP ID:**

2.70.4.2

**Telnet path:**

**Setup > IPv6 > Network > Parameter**

**Interface name**

Give a name to the interface for which the IPv6 parameters are to be configured.

**SNMP ID:**

2.70.4.2.1

**Telnet path:**

**Setup > IPv6 > Network > Parameter > Interface-Name**

**Possible values:**

Max. 16 characters

**Default:**

Blank

**IPv6 gateway**

Specify the IPv6 gateway to be used by this interface.

---

 This parameter overrides gateway information that the device may receive via router advertisements, for example.

**SNMP ID:**

2.70.4.2.2

**Telnet path:**

**Setup > IPv6 > Network > Parameter > IPv6-Gateway**

**Possible values:**

- Global unicast address, e.g. 2001:db8::1
- Link-local address to which you add to the corresponding interface (%<INTERFACE>), e.g. fe80::1%INTERNET

**Default:**

::

**Primary DNS**

Specify the primary IPv6 DNS server to be used by this interface.

**SNMP ID:**

2.70.4.2.3

**Telnet path:**

**Setup > IPv6 > Network > Parameter > Primary-DNS**

**Possible values:**

IPv6 address with max. 39 characters

**Default:**

::

**Secondary DNS**

Specify the secondary IPv6 DNS server to be used by this interface.

**SNMP ID:**

2.70.4.2.4

**Telnet path:**

**Setup > IPv6 > Network > Parameter > Secondary-DNS**

**Possible values:**

IPv6 address with max. 39 characters

**Default:**

::

## 9.6.6 Firewall

This menu contains the settings for the firewall.

**SNMP ID:**

2.70.5

**Telnet path:**

**Setup > IPv6 > Firewall**

### Operating

Enables or disables the firewall.



This item enables the firewall globally. The firewall is only active if you enable it here. If you disable the firewall here and at the same time enable it for individual interfaces, it remains disabled for all interfaces.

**SNMP ID:**

2.70.5.1

**Telnet path:**

**Setup > IPv6 > Firewall > Operating**

**Possible values:**

Yes

No

**Default:**

Yes

### Forwarding rules

This table contains the rules that the firewall will apply for forwarding data.

**SNMP ID:**

2.70.5.2

**Telnet path:****Setup > IPv6 > Firewall > Forwarding-Rules****Name**

Defines the name for the forwarding rule.

**SNMP ID:**

2.70.5.2.1

**Telnet path:****Setup > IPv6 > Firewall > Forwarding-Rules****Possible values:**

Maximum 36 characters from: ABCDEFGHIJKLMNOPQRSTUVWXYZ@{}~!\$%&amp;'()+,./:;&lt;=&gt;?[\]^\_0123456789

**Default:**

Blank

**Flags**

These options determine how the firewall handles the rule. The options have the following meanings:

- **Deactivated:** The rule is disabled. The firewall skips this rule.
- **Linked:** After processing the rule, the firewall looks for additional rules which come in question.
- **Stateless:** This rule does not take the statuses of the TCP sessions into account.

You can select several options at the same time.

**SNMP ID:**

2.70.5.2.2

**Telnet path:****Setup > IPv6 > Firewall > Forwarding-Rules****Possible values:**Deactivated  
Linked  
Stateless**Default:**

No selection

**Priority**

This information determines the priority with which the firewall applies the rule. A higher value determines a higher priority.

**SNMP ID:**

2.70.5.2.3

**Telnet path:****Setup > IPv6 > Firewall > Forwarding-Rules**

**Possible values:**

Max. 4 characters from 1234567890

**Default:**

0

**Routing tag**

The interface tag that you enter here is a value that uniquely identifies the network. All packets received by this device on this network will be internally marked with this tag. The interface tag makes it possible to separate the rules valid for this network.

**SNMP ID:**

2.70.5.2.4

**Telnet path:**

**Setup > IPv6 > Firewall > Forwarding-Rules**

**Possible values:**

Max. 5 characters from 1234567890

**Default:**

0

**Action**

Specifies the action that the firewall performs if the rule condition is true. There are certain standard actions already specified in the table **Setup IPv > IPv6 > Firewall > Actions**. In addition, you can also define your own actions.

You can enter multiple actions, separated by commas.

**SNMP ID:**

2.70.5.2.5

**Telnet path:**

**Setup > IPv6 > Firewall > Forwarding-Rules**

**Possible values:**

Maximum 64 characters from:  
#ABCDEFGHIJKLMNOPQRSTUVWXYZ@{ }~!\$%&'()+-./:;<=>?[ ]^\_ .0123456789abcdefghijklmnopqrstuvwxyz`

**Default:**

REJECT

**Services**

This information determines for which services the firewall applies this rule. There are certain services already specified in the table **Setup > IPv6 > Firewall > Actions**. In addition, you can also define your own services.

You can enter multiple services separated by commas.

**SNMP ID:**

2.70.5.2.7

**Telnet path:**

**Setup > IPv6 > Firewall > Forwarding-Rules**

**Possible values:**

Maximum 64 characters from:

#ABCDEFGHIJKLMNOPQRSTUVWXYZ@[]~!\$%&'()+,-./:;<=>?[\]^\_0123456789abcdefghijklmnopqrstuvwxyz`

**Default:**

ANY

**Source stations**

This information determines for which source stations the firewall applies this rule. There are certain stations already specified in the table **Setup > IPv6 > Firewall > Stations**. In addition, you can also define your own stations.

You can enter multiple stations separated by commas.

**SNMP ID:**

2.70.5.2.8

**Telnet path:**

**Setup > IPv6 > Firewall > Forwarding-Rules**

**Possible values:**

Maximum 64 characters from:

#ABCDEFGHIJKLMNOPQRSTUVWXYZ@[]~!\$%&'()+,-./:;<=>?[\]^\_0123456789abcdefghijklmnopqrstuvwxyz`

**Default:**

ANYHOST

**Destination stations**

This information determines, for which destination stations the firewall applies this rule. There are certain stations already specified in the table **Setup > IPv6 > Firewall > Stations**. In addition, you can also define your own stations.

You can enter multiple stations separated by commas.

**SNMP ID:**

2.70.5.2.9

**Telnet path:**

**Setup > IPv6 > Firewall > Forwarding-Rules**

**Possible values:**

Maximum 64 characters from:

#ABCDEFGHIJKLMNOPQRSTUVWXYZ@[]~!\$%&'()+,-./:;<=>?[\]^\_0123456789abcdefghijklmnopqrstuvwxyz`

**Default:**

ANYHOST

**Comment**

Enter a descriptive comment for this entry.

**SNMP ID:**

2.70.5.2.10

**Telnet path:**

**Setup > IPv6 > Firewall > Forwarding-Rules**

**Possible values:**

Maximum 64 characters from:  
 #ABCDEFGHIJKLMNOPQRSTUVWXYZ@{}~!\$%&'()+-./:;<=>?[\]^\_0123456789abcdefghijklmnopqrstuvwxyz`

**Default:**

Blank

**Actions list**

In this table, you can group actions. Define the actions you previously under **Setup > IPv6 > Firewall > Actions**.

 You can not delete an action in this list if the firewall is used in a forwarding or inbound rule.

**SNMP ID:**

2.70.5.3

**Telnet path:**

**Setup > IPv6 > Firewall > Action-List**

**Name**

Specifies the name of a group of actions.

**SNMP ID:**

2.70.5.3.1

**Telnet path:**

**Setup > IPv6 > Firewall > Action-List**

**Possible values:**

Maximum 36 characters from: ABCDEFGHIJKLMNOPQRSTUVWXYZ@{}~!\$%&'()+-./:;<=>?[\]^\_0123456789

**Default:**

Blank

**Description**

Contains the list of actions that are grouped together under this group name.

Separate the individual entries with a comma.

**SNMP ID:**

2.70.5.3.2

**Telnet path:**

**Setup > IPv6 > Firewall > Action-List**

**Possible values:**

Maximum 252 characters from:  
 #ABCDEFGHIJKLMNOPQRSTUVWXYZ@{}~!\$%&'()+-./:;<=>?[\]^\_0123456789abcdefghijklmnopqrstuvwxyz`

**Default:**

Blank

**Station list**

You can group stations in this table. Define the actions previously under **Setup > IPv6 > Firewall > Stations**.



---

 You can not delete a station in this list if the firewall is used in a forwarding or inbound rule.

**SNMP ID:**

2.70.5.5

**Telnet path:****Setup > IPv6 > Firewall > Stations-List****Name**

Specifies the name of a group of stations.

**SNMP ID:**

2.70.5.5.1

**Telnet path:****Setup > IPv6 > Firewall > Stations-List****Possible values:**

Maximum 36 characters from: ABCDEFGHIJKLMNOPQRSTUVWXYZ@{}~!\$%&amp;'()\*+,-./:;&lt;=&gt;?[\]^\_0123456789

**Default:**

Blank

**Description**

Contains the list of stations that are grouped together under this group name.

Separate the individual entries with a comma.

**SNMP ID:**

2.70.5.5.2

**Telnet path:****Setup > IPv6 > Firewall > Stations-List****Possible values:**

Maximum 252 characters from:

#ABCDEFGHIJKLMNOPQRSTUVWXYZ@{}~!\$%&amp;'()\*+,-./:;&lt;=&gt;?[\]^\_0123456789abcdefghijklmnopqrstuvwxyz`

**Default:**

Blank

**Service list**You can group services in this table. Define the services previously under **Setup > IPv6 > Firewall > Services**.

---

 You can not delete a service in this list if the firewall is used in a forwarding or inbound rule.

**SNMP ID:**

2.70.5.6

**Telnet path:****Setup > IPv6 > Firewall > Service-List****Name**

Specifies the name of a group of services.

**SNMP ID:**

2.70.5.6.1

**Telnet path:****Setup > IPv6 > Firewall > Service-List****Possible values:**

Maximum 36 characters from: ABCDEFGHIJKLMNOPQRSTUVWXYZ@{}~!\$%&amp;'()+-./:;&lt;=&gt;?[\]^\_0123456789

**Default:**

Blank

**Description**

Contains the list of services that are grouped together under this group name.

Separate the individual entries with a comma.

**SNMP ID:**

2.70.5.6.2

**Telnet path:****Setup > IPv6 > Firewall > Service-List****Possible values:**

Maximum 252 characters from:

#ABCDEFGHIJKLMNOPQRSTUVWXYZ@{}~!\$%&amp;'()+-./:;&lt;=&gt;?[\]^\_0123456789abcdefghijklmnopqrstuvwxyz`

**Default:**

Blank

**Actions**

The firewall can perform the forwarding and inbound rule actions for the actions contained in this table.

You can combine multiple actions under **Setup > IPv6 > Firewall > Actions-list**.**SNMP ID:**

2.70.5.7

**Telnet path:****Setup > IPv6 > Firewall > Actions****Name**

Specifies the name of the action.

**SNMP ID:**

2.70.5.7.1

**Telnet path:****Setup > IPv6 > Firewall > Actions****Possible values:**

Maximum 32 characters from: ABCDEFGHIJKLMNOPQRSTUVWXYZ@{}~!\$%&amp;'()+-./:;&lt;=&gt;?[\]^\_0123456789

**Default:**

Blank

**Limit**

When this limit is exceeded, the firewall applies the filter rule.

**SNMP ID:**

2.70.5.7.2

**Telnet path:**

**Setup > IPv6 > Firewall > Actions**

**Possible values:**

Max. 10 characters from 0123456789

**Special values:**

0: The rule will come into force immediately.

**Default:**

0

**Unit**

Determines the unit for the limits.

**SNMP ID:**

2.70.5.7.3

**Telnet path:**

**Setup > IPv6 > Firewall > Actions**

**Possible values:**

kBit

kByte

Packets

Sessions

Bandwidth (%)

**Default:**

Packets

**Time**

Determines the measurement period that the firewall applies to the limit.

**SNMP ID:**

2.70.5.7.4

**Telnet path:**

**Setup > IPv6 > Firewall > Actions**

**Possible values:**

Second

Minute

Hour

Absolute

**Default:**

Absolute

**Context**

Determines the context that the firewall applies to the limit. Possible values are:

- **Session:** The limit only applies to the data traffic for the current session.
- **Station:** The limit only applies to the data traffic for the current station.
- **Global:** All sessions to which this rule applies use the same limit counter.

**SNMP ID:**

2.70.5.7.5

**Telnet path:****Setup > IPv6 > Firewall > Actions****Possible values:**

Session

Station

Global

**Default:**

Session

**Flags**

Determines the properties of the limits of the action. Possible values are:

- **Reset:** If the limit is exceeded, the action resets the counter.
- **Shared:** All rules to which this limit applies use the same limit counter.

**SNMP ID:**

2.70.5.7.6

**Telnet path:****Setup > IPv6 > Firewall > Actions****Possible values:**

Reset

Shared

**Default:**

Blank

**Action**

Determines the action the firewall performs when the limit is reached.

The following options are possible:

- **Reject:** The firewall rejects the data packet and sends an appropriate notification to the sender.
- **Drop:** The firewall discards the data packet without notification.
- **Accept:** The firewall accepts the data packet.

**SNMP ID:**

2.70.5.7.7

**Telnet path:**

**Setup > IPv6 > Firewall > Actions**

**Possible values:**

Reject

Drop

Accept

**Default:**

.

**DiffServ**

Determines the priority of the data packets (differentiated services, DiffServ), with which the firewall should transfer the data packets.



Further information about DiffServ CodePoints is available in the Reference Manual under the section "QoS".

**SNMP ID:**

2.70.5.7.11

**Telnet path:**

**Setup > IPv6 > Firewall > Actions**

**Possible values:**

BE

EF

CS0 to CS7

AF11 to AF43

No

Value

**Special values:**

**Value:** You can enter the DSCP decimal value directly in the **DSCP value** field.

**Default:**

No

**DSCP value**

Determines the value for the Differentiated Services Code Point (DSCP).

If you selected the "Value" option in the **DiffServ** field, enter a value here.



Further information about DiffServ CodePoints is available in the Reference Manual under the section "QoS".

**SNMP ID:**

2.70.5.7.12

**Telnet path:**

**Setup > IPv6 > Firewall > Actions**

**Possible values:**

Max. 2 characters from 1234567890

**Default:**

0

**Conditions**

Determines which conditions must be met in order for the action to be performed. Define the conditions under **Setup > IPv6 > Firewall > Conditions**.

**SNMP ID:**

2.70.5.7.13

**Telnet path:**

**Setup > IPv6 > Firewall > Actions**

**Possible values:**

Maximum 32 characters from: ABCDEFGHIJKLMNOPQRSTUVWXYZ@{}~!\$%&'()+,./:;<=>?[\]^\_0123456789

**Default:**

Blank

**Trigger actions**

Determines which trigger actions the firewall should start in addition to filtering the data packets. Define the trigger actions under **Setup > IPv6 > Firewall > Trigger-actions**.

**SNMP ID:**

2.70.5.7.14

**Telnet path:**

**Setup > IPv6 > Firewall > Actions**

**Possible values:**

Maximum 32 characters from: ABCDEFGHIJKLMNOPQRSTUVWXYZ@{}~!\$%&'()+,./:;<=>?[\]^\_0123456789

**Default:**

Blank

**Stations**

The firewall can perform the forwarding and inbound rule actions for inbound connections from the source stations listed in this table.

You can combine multiple stations under **Setup > IPv6 > Firewall > Station-list**.

**SNMP ID:**

2.70.5.9

**Telnet path:**

**Setup > IPv6 > Firewall > Stations**

**Name**

Specifies the name of the station.

**SNMP ID:**

2.70.5.9.1

**Telnet path:****Setup > IPv6 > Firewall > Stations****Possible values:**

Maximum 32 characters from: ABCDEFGHIJKLMNOPQRSTUVWXYZ@{}~!\$%&amp;'()+,/:;&lt;=&gt;?[\\]^\_0123456789

**Default:**

Blank

**Type**

Determines the station type.

**SNMP ID:**

2.70.5.9.2

**Telnet path:****Setup > IPv6 > Firewall > Stations****Possible values:**

Local network

Remote peer

Prefix

Identifier

IP address

Named host

**Default:**

Local network

**Local network**If you selected the appropriate option in the **Type** field, you enter the name of the local network here.**SNMP ID:**

2.70.5.9.3

**Telnet path:****Setup > IPv6 > Firewall > Stations****Possible values:**

Max. 16 characters from: #ABCDEFGHIJKLMNOPQRSTUVWXYZ@{}~!\$%&amp;'()+,/:;&lt;=&gt;?[\\]^\_0123456789

**Default:**

Blank

**Remote peer/local host**If you selected the appropriate option in the **Type** field, you enter the name of the remote peer or local host here.**SNMP ID:**

2.70.5.9.6

**Telnet path:****Setup > IPv6 > Firewall > Stations**

**Possible values:**

Maximum 64 characters from: ABCDEFGHIJKLMNOPQRSTUVWXYZ@{}~!\$%&'()+,./:;<=>?[\\]^\_0123456789

**Default:**

Blank

**Address/Prefix**

If you selected the appropriate option in the **Type** field, enter the IP address or prefix of the station here.

**SNMP ID:**

2.70.5.9.7

**Telnet path:**

**Setup > IPv6 > Firewall > Stations**

**Possible values:**

Max. 43 characters from ABCDEFabcdef0123456789:

**Default:**

Blank

**Services**

The firewall can perform the forwarding and inbound rule actions for the connection protocols of the services listed in this table.

You can combine multiple services under **Setup > IPv6 > Firewall > Service-list**.

**SNMP ID:**

2.70.5.10

**Telnet path:**

**Setup > IPv6 > Firewall > Services**

**Name**

Specifies the name of the service.

**SNMP ID:**

2.70.5.10.1

**Telnet path:**

**Setup > IPv6 > Firewall > Services**

**Possible values:**

Maximum 32 characters from: ABCDEFGHIJKLMNOPQRSTUVWXYZ@{}~!\$%&'()+,./:;<=>?[\\]^\_0123456789

**Default:**

Blank

**Protocol**

Specifies the protocol of the service.

**SNMP ID:**

2.70.5.10.2



**Telnet path:****Setup > IPv6 > Firewall > Services****Possible values:**

TCP+UDP

TCP

UDP

**Default:**

TCP+UDP

**Ports**

Specifies the port for the service. Separate multiple ports with a comma.

Lists with the official protocol and port numbers are available in the Internet at [www.iana.org](http://www.iana.org).**SNMP ID:**

2.70.5.10.3

**Telnet path:****Setup > IPv6 > Firewall > Services****Possible values:**

Max. 64 characters from 0123456789,

**Default:**

Blank

**Source ports**

Determines whether the specified ports are source ports.



In certain scenarios, it may be useful to specify a source port. This is unusual. Selecting "No" is recommended.

**SNMP ID:**

2.70.5.10.4

**Telnet path:****Setup > IPv6 > Firewall > Stations****Possible values:**

No

Yes

**Default:**

No

**Protocol**

The firewall can perform the forwarding and inbound rule actions for the protocols listed in this table.

**SNMP ID:**

2.70.5.11

**Telnet path:****Setup > IPv6 > Firewall > Protocols****Name**

Specifies the name of the protocol.

**SNMP ID:**

2.70.5.11.1

**Telnet path:****Setup > IPv6 > Firewall > Protocols****Possible values:**

Maximum 32 characters from: ABCDEFGHIJKLMNOPQRSTUVWXYZ@{}~!\$%&amp;'()+,./:;&lt;=&gt;?[\]^\_0123456789

**Default:**

Blank

**Protocol**

Specifies the protocol number.

---

 Lists with the official protocol and port numbers are available in the Internet at [www.iana.org](http://www.iana.org).
**SNMP ID:**

2.70.5.11.2

**Telnet path:****Setup > IPv6 > Firewall > Protocols****Possible values:**

Max. 3 characters from 0123456789

**Default:**

Blank

**Conditions**

The firewall can perform the forwarding and inbound rule actions for the conditions listed in this table.

**SNMP ID:**

2.70.5.12

**Telnet path:****Setup > IPv6 > Firewall > Conditions****Name**

Specifies the name of the condition.

**SNMP ID:**

2.70.5.12.1

**Telnet path:****Setup > IPv6 > Firewall > Conditions**

**Possible values:**

Maximum 32 characters from: ABCDEFGHIJKLMNOPQRSTUVWXYZ@{}~!\$%&'()+,-./:;<=>?[]^\_0123456789

**Default:**

Blank

**Conditions**

Specifies the conditions which must be met.

**SNMP ID:**

2.70.5.12.2

**Telnet path:**

**Setup > IPv6 > Firewall > Conditions**

**Possible values:**

Not connected  
 Default route  
 Backup connection  
 VPN route  
 Transmitted  
 Received

**Default:**

Blank

**Transport direction**

Determines whether the transport direction refers to the logical connection or the physical data transmission over the respective interface.

**SNMP ID:**

2.70.5.12.3

**Telnet path:**

**Setup > IPv6 > Firewall > Conditions**

**Possible values:**

Physical  
 Logical

**Default:**

Physical

**DiffServ**

Determines the priority that the data packets (differentiated services, DiffServ) have to have, so that the condition is met.

 Further information about DiffServ CodePoints is available in the Reference Manual under the section "QoS".

**SNMP ID:**

2.70.5.7.11

**Telnet path:****Setup > IPv6 > Firewall > Actions****Possible values:**

BE

EF

CS0 to CS7, CSx

AF11 to AF43, AF1x, AF2x, AF3x, AF4x, AFx1, AFx2, AFx3, AFxx

No

Value

**Special values:****CSx:** Extends the range to all class selectors.**AF1x, AF2x, AF3x, AF4x, AFx1, AFx2, AFx3, AFxx:** Extends the range to the corresponding assured-forwarding classes (e.g., AF1x takes the classes AF11, AF12, AF13 into account)**Value:** You can enter the DSCP decimal value directly in the **DSCP value** field.**Default:**

Ignore

**DSCP value**

Determines the value for the Differentiated Services Code Point (DSCP).

If you selected the "Value" option in the **DiffServ** field, enter a value here.

Further information about DiffServ CodePoints is available in the Reference Manual under the section "QoS".

**SNMP ID:**

2.70.5.12.5

**Telnet path:****Setup > IPv6 > Firewall > Actions****Possible values:**

Max. 2 characters from 1234567890

**Default:**

0

**Trigger actions**

This table contains a list of the trigger actions, which the firewall actions can start.

**SNMP ID:**

2.70.5.13

**Telnet path:****Setup > IPv6 > Firewall > Trigger-Actions****Name**

Specifies the name of the trigger action.

**SNMP ID:**

2.70.5.13.1

**Telnet path:****Setup > IPv6 > Firewall > Trigger-Actions****Possible values:**

Maximum 32 characters from: ABCDEFGHIJKLMNOPQRSTUVWXYZ@{}~!\$%&amp;'()\*+,-./:;&lt;=&gt;?[\]^\_0123456789

**Default:**

Blank

**Notifications**

Determines whether and how a notification should be sent.



If you want to receive e-mail notifications, you must enter an e-mail address in **Setup > IP-Router > Firewall > Admin-Email**.

**SNMP ID:**

2.70.5.13.2

**Telnet path:****Setup > IPv6 > Firewall > Trigger-Actions****Possible values:**

SNMP

SYSLOG

E-mail

**Default:**

Blank

**Disconnect**

Determines whether the firewall disconnects the connection to the remote station if the filter condition is true.

**SNMP ID:**

2.70.5.13.3

**Telnet path:****Setup > IPv6 > Firewall > Trigger-Actions****Possible values:**

No

Yes

**Default:**

No

**Block source**Determines whether the firewall disconnects the source if the filter condition is true. The firewall registers the blocked IP address, the lockout period, as well as the underlying rule in the **Host-lock-list** under **Status > IPv6 > Firewall**.**SNMP ID:**

2.70.5.13.4

**Telnet path:**

**Setup > IPv6 > Firewall > Trigger-Actions**

**Possible values:**

No

Yes

**Default:**

No

**Lockout period**

Specifies how many minutes the firewall blocks the source.

**SNMP ID:**

2.70.5.13.5

**Telnet path:**

**Setup > IPv6 > Firewall > Trigger-Actions**

**Possible values:**

Max. 8 characters from 0123456789

**Special values:**

0: Disables the lock because, in practice, the lockout period expires after 0 minutes.

**Default:**

0

**Close destination**

Specifies whether the firewall disconnects the source if the filter condition is true. The firewall registers the blocked destination IP address, the protocol, the destination port, the lockout period, as well as the underlying rule in the **Port-block-list** under **Status > IPv6 > Firewall**.

**SNMP ID:**

2.70.5.13.6

**Telnet path:**

**Setup > IPv6 > Firewall > Trigger-Actions**

**Possible values:**

No

Yes

**Default:**

No

**Closing time**

Determines, for how many seconds the firewall closes the destination.

**SNMP ID:**

2.70.5.13.7

**Telnet path:**

**Setup > IPv6 > Firewall > Trigger-Actions**

**Possible values:**

Max. 8 characters from 0123456789

**Special values:**

0: Disables the lock because, in practice, the lockout period expires after 0 minutes.

**Default:**

0

**ICMP service**

This table contains a list of ICMP-service.



Since ICMPv6 has central importance for numerous IPv6 features, basic ICMPv6 rules are already configured by default. You can not delete these rules.

**SNMP ID:**

2.70.5.14

**Telnet path:**

**Setup > IPv6 > Firewall > ICMP-Services**

**Name**

Specifies the name of the ICMP service.

**SNMP ID:**

2.70.5.14.1

**Telnet path:**

**Setup > IPv6 > Firewall > ICMP-Services**

**Possible values:**

Maximum 32 characters from: ABCDEFGHIJKLMNOPQRSTUVWXYZ@{}~!\$%&'()\*+,-./:;<=>?[\]^\_0123456789

**Default:**

Blank

**Type**

Specifies the type of the ICMP service.



Lists with the official ICMP types and port codes are available in the Internet under [www.iana.org](http://www.iana.org).

**SNMP ID:**

2.70.5.14.2

**Telnet path:**

**Setup > IPv6 > Firewall > ICMP-Services**

**Possible values:**

Max. 3 characters from 0123456789

**Default:**

0

**Code**

Specifies the codes of the ICMP service.

 Lists with the official ICMP types and port codes are available in the Internet under [www.iana.org](http://www.iana.org).

**SNMP ID:**

2.70.5.14.2

**Telnet path:**

**Setup > IPv6 > Firewall > ICMP-Services**

**Possible values:**

Max. 3 characters from 0123456789

**Default:**

0

**Inbound rules**

This table contains the rules that the firewall will apply to inbound connections.

By default, there are already some rules for the most important cases.

**SNMP ID:**

2.70.5.15

**Telnet path:**

**Setup > IPv6 > Firewall > Inbound-Rules**

**Name**

Specifies the name of the inbound rule.

**SNMP ID:**

2.70.5.15.1

**Telnet path:**

**Setup > IPv6 > Firewall > Inbound-Rules**

**Possible values:**

Maximum 36 characters from: ABCDEFGHIJKLMNOPQRSTUVWXYZ@{}~!\$%&'()\*+,-./:;<=>?[\]^\_0123456789

**Default:**

Blank

**Active**

This option enables the inbound rule.

**SNMP ID:**

2.70.5.15.2

**Telnet path:**

**Setup > IPv6 > Firewall > Inbound-Rules**

**Possible values:**

Yes

No



**Default:**

Yes

**Priority**

This information determines the priority with which the firewall applies the rule. A higher value determines a higher priority.

**SNMP ID:**

2.70.5.15.3

**Telnet path:****Setup > IPv6 > Firewall > Inbound-Rules****Possible values:**

Max. 4 characters from 1234567890

**Default:**

0

**Action**

Specifies the action that the firewall performs if the rule condition is true. There are certain standard actions already specified in the table **Setup IPv > IPv6 > Firewall > Actions**. In addition, you can also define your own actions.

**SNMP ID:**

2.70.5.15.5

**Telnet path:****Setup > IPv6 > Firewall > Inbound-Rules****Possible values:**

Maximum 64 characters from:  
 #ABCDEFGHIJKLMNOPQRSTUVWXYZ@{ }~!\$%&'()\*+,-./:;<=>?[\]^\_0123456789abcdefghijklmnopqrstuvwxyz`

**Default:**

REJECT

**Services**

This information determines for which services the firewall applies this rule. There are certain services already specified in the table **Setup > IPv6 > Firewall > Actions**. In addition, you can also define your own services.

**SNMP ID:**

2.70.5.15.7

**Telnet path:****Setup > IPv6 > Firewall > Inbound-Rules****Possible values:**

Maximum 64 characters from:  
 #ABCDEFGHIJKLMNOPQRSTUVWXYZ@{ }~!\$%&'()\*+,-./:;<=>?[\]^\_0123456789abcdefghijklmnopqrstuvwxyz`

**Default:**

ANY

**Source stations**

This information determines for which source stations the firewall applies this rule. There are certain stations already specified in the table **Setup > IPv6 > Firewall > Stations**. In addition, you can also define your own stations.

**SNMP ID:**

2.70.5.15.8

**Telnet path:****Setup > IPv6 > Firewall > Inbound-Rules****Possible values:**

Maximum 64 characters from:

#ABCDEFGHIJKLMNOPQRSTUVWXYZ@[{}~!\$%&amp;'()+,-./:;&lt;=&gt;?[\\]^\_0123456789abcdefghijklmnopqrstuvwxyz`

**Default:**

ANYHOST

**Comment**

Enter a descriptive comment for this entry.

**SNMP ID:**

2.70.5.15.10

**Telnet path:****Setup > IPv6 > Firewall > Inbound-Rules****Possible values:**

Maximum 64 characters from:

#ABCDEFGHIJKLMNOPQRSTUVWXYZ@[{}~!\$%&amp;'()+,-./:;&lt;=&gt;?[\\]^\_0123456789abcdefghijklmnopqrstuvwxyz`

**Default:**

Blank

## 9.6.7 LAN interfaces

This table contains the settings for the LAN interfaces.

**SNMP ID:**

2.70.6

**Telnet path:****Setup > IPv6 > LAN-Interfaces****Interface name**

Enter a name for the logical IPv6 interface that is defined by the physical interface (interface assignment) and the VLAN ID.

**SNMP ID:**

2.70.6.1

**Telnet path:****Setup > IPv6 > LAN-Interfaces > Interface-Name****Possible values:**

Max. 16 characters

**Default:**

Blank

**Interface ID**

Select the physical interface to be combined with the VLAN ID to form the logical IPv6 interface.

**SNMP ID:**

2.70.6.2

**Telnet path:****Setup > IPv6 > LAN-Interfaces > Interface-ID****Possible values:**

All physically available interfaces on the device

**Default:**

LAN-1

**VLAN ID**

Select the VLAN ID to be combined with the physical interface to form the logical IPv6 interface.

---

 If you enter an invalid VLAN ID here, no communication will take place.

**SNMP ID:**

2.70.6.3

**Telnet path:****Setup > IPv6 > LAN-Interfaces > VLAN-ID****Possible values:**

0 to 4096

Max. 4 numbers

**Default:**

0

**Routing tag**

The interface tag that you enter here is a value that uniquely identifies the network. All packets received by this device on this network will be internally marked with this tag. The interface tag enables the routes which are valid for this network to be separated even without explicit firewall rules.

**SNMP ID:**

2.70.6.4

**Telnet path:****Setup > IPv6 > LAN-Interfaces > Rtg-Tag****Possible values:**

Max. 5 characters in the range 0 – 65535

**Default:**

0

## Autoconf

Enable or disable "stateless address autoconfiguration" for this interface.

---

 If the device sends router advertisements from this interface, it does not generate any IPv6 addresses even with auto-configuration enabled.

**SNMP ID:**

2.70.6.5

**Telnet path:**

**Setup > IPv6 > LAN-Interfaces > Autoconf**

**Possible values:**

Yes

No

**Default:**

Yes

## Accept RA

Enables or disables the processing of received router advertisement messages.

---

 With processing disabled, the device ignores any prefix, DNS and router information received via router advertisements.

**SNMP ID:**

2.70.6.6

**Telnet path:**

**Setup > IPv6 > LAN-Interfaces > Accept-RA**

**Possible values:**

Yes

No

**Default:**

Yes

## Interface status

Enables or disables this interface.

**SNMP ID:**

2.70.6.7

**Telnet path:**

**Setup > IPv6 > LAN-Interfaces > Interface-Status**

**Possible values:**

Up

Down

**Default:**

Up

## Forwarding

Enables or disables the forwarding of data packets to other interfaces.

 With forwarding disabled, no router advertisements are transmitted from this interface.

### SNMP ID:

270.6.8

### Telnet path:

**Setup > IPv6 > LAN-Interfaces > Forwarding**

### Possible values:

Yes

No

### Default:

Yes

## MTU

Specify the applicable MTU for this interface.

### SNMP ID:

2.70.6.9

### Telnet path:

**Setup > IPv6 > LAN-Interfaces > MTU**

### Possible values:

Max. 4 numbers in the range 0 – 9999

### Default:

1500

## Firewall

If the global firewall is enabled for IPv6 interfaces, you can disable the firewall for an individual interface here. To enable the firewall globally for all interfaces, select **IPv6 firewall/QoS enabled** in the menu **Firewall/QoS > General** .

 If you disable the global firewall, the firewall of an individual interface is also disabled. This applies even if you have enabled this option.

### SNMP ID:

2.70.6.10

### Telnet path:

**Setup > IPv6 > LAN-Interfaces > Firewall**

### Possible values:

Yes

No

### Default:

No

### Comment

Enter a descriptive comment for this entry.

 Entering a comment is optional.

**SNMP ID:**

2.70.6.11

**Telnet path:**

**Setup > IPv6 > LAN-Interfaces > Comment**

**Possible values:**

Max. 64 characters

**Default:**

Blank

## 9.6.8 WAN interfaces

This table contains the settings for the LAN interfaces.

**SNMP ID:**

2.70.7

**Telnet path:**

**Setup > IPv6 > WAN-Interfaces**

### Interface name

Specify the name of the WAN remote peer here. Use the name as specified at the remote site.

**SNMP ID:**

2.70.7.1

**Telnet path:**

**Setup > IPv6 > WAN-Interfaces > Interface-Name**

**Possible values:**

Max. 16 characters

**Default:**

Blank

### Routing tag

The interface tag that you enter here is a value that uniquely identifies the network. All packets received by this device on this network will be internally marked with this tag. The interface tag enables the routes which are valid for this network to be separated even without explicit firewall rules.

**SNMP ID:**

2.70.7.2

**Telnet path:**

**Setup > IPv6 > WAN-Interfaces > Rtg-Tag**

**Possible values:**

Max. 5 characters in the range 0 – 65534

**Default:**

0

**Autoconf**

Enable or disable "stateless address autoconfiguration" for this interface.

---

 If the device sends router advertisements from this interface, it does not generate any addresses even with auto-configuration enabled.

**SNMP ID:**

2.70.7.3

**Telnet path:****Setup > IPv6 > WAN-Interfaces > Autoconf****Possible values:**

Yes

No

**Default:**

Yes

**Accept RA**

Enables or disables the processing of received router advertisement messages.

---

 With processing disabled, the device ignores any prefix, DNS and router information received via router advertisements.

**SNMP ID:**

2.70.6.6

**Telnet path:****Setup > IPv6 > WAN-Interfaces > Accept-RA****Possible values:**

Yes

No

**Default:**

Yes

**Interface status**

Enables or disables this interface.

**SNMP ID:**

2.70.7.5

**Telnet path:****Setup > IPv6 > WAN-Interfaces > Interface-Status****Possible values:**

Up

Down

**Default:**

Up

**Forwarding**

Enables or disables the forwarding of data packets to other interfaces.

**SNMP ID:**

2.70.7.6

**Telnet path:****Setup > IPv6 > WAN-Interfaces > Forwarding****Possible values:**

Yes

No

**Default:**

Yes

**Firewall**

Enables the firewall for this interface.



If you disable the global firewall, the firewall of an individual interface is also disabled. This applies even if you have enabled this option.

**SNMP ID:**

2.70.7.7

**Telnet path:****Setup > IPv6 > WAN-Interfaces > Firewall****Possible values:**

Yes

No

**Default:**

Yes

**Comment**

Enter a descriptive comment for this entry.



Entering a comment is optional.

**SNMP ID:**

2.70.7.8

**Telnet path:****Setup > IPv6 > WAN-Interfaces > Comment****Possible values:**

Max. 64 characters

**Default:**

Blank



## DaD attempts

Before the device can use an IPv6 address on an interface, it uses 'Duplicate Address Detection (DAD)' to check to see whether the IPv6 address already exists on the local network. In this way the device avoids address conflicts on the network.

This option specifies the number of times that the device attempts to find duplicate IPv6 addresses on the network.

### Telnet path:

**Setup > IPv6 > WAN-Interfaces > DaD-Attempts**

### Possible values:

Max. 1 number

### Default:

1

## 9.6.9 Operating

Switches the IPv6 stack on or off, globally. With the IPv6 stack deactivated, the device does not perform any IPv6-related functions.

### SNMP ID:

2.70.10

### Telnet path:

**Setup > IPv6 > Operating**

### Possible values:

Yes

No

### Default:

No

## 9.6.10 Forwarding

If forwarding is turned off, the device transmits no data packets between IPv6 interfaces.



Forwarding is essential if you wish to operate the device as a router.

### SNMP ID:

2.70.11

### Telnet path:

**Setup > IPv6 > Forwarding**

### Possible values:

Yes

No

### Default:

Yes

## 9.6.11 Router

These are the router settings.

**SNMP ID:**

2.70.12

**Telnet path:****Setup > IPv6 > Router****Routing table**

The table contains the entries to be used for routing packets with IPv6 addresses.

**SNMP ID:**

2.70.12.1

**Telnet path:****Setup > IPv6 > Router > Routing-Table****Prefix**

This prefix denotes the network range from which the current remote site, e.g. 2001:db8::/32, is to receive data

**SNMP ID:**

2.70.12.1.1

**Telnet path:****Setup > IPv6 > Router > Routing-Table > Prefix****Possible values:**

Max. 43 characters

**Default:**

Blank

**Routing tag**

Specify the routing tag for this route. This route is active only for packets with the same tag. The data packets receive the routing tag either from the firewall or depending on the LAN or WAN interface used.



Routing tags are only necessary if used in combination with routing tags as set by firewall rules or as set at an interface.

**SNMP ID:**

2.70.12.1.2

**Telnet path:****Setup > IPv6 > Router > Routing-Table > Routing-Tag****Possible values:**

Max. 5 characters

**Default:**

Blank

**Peer or IPv6**

This is where you specify the remote site for this route. Enter one of the following options:

- An interface name
- An IPv6 address (e.g. 2001:db8::1)
- An interface supplemented with a link-local address (e.g. fe80::1%INTERNET)

---

 The device stores the remote sites for IPv6 routing as (*WAN interfaces*).

**SNMP ID:**

2.70.12.1.3

**Telnet path:****Setup > IPv6 > Router > Routing-Table > Peer-or-IPv6****Possible values:**

Max. 56 characters

**Default:**

Blank

**Comment**

Enter a descriptive comment for this entry.

---

 Entering a comment is optional.

**SNMP ID:**

2.70.12.1.4

**Telnet path:****Setup > IPv6 > Router > Routing-Table > Comment****Possible values:**

Max. 64 characters

**Default:**

Blank

**Destination cache timeout**

The 'destination cache timeout' specifies how long the device remembers the path to a destination address when no packets are sent to it.

This value also influences the length of time the device takes to change the settings of the firewall: It accepts state changes after at least half of the 'destination cache timeout' time, on average after one quarter of the timeout. Thus with the default setting of 30 seconds, changes to the firewall come into effect on average after 7.5 seconds, but no later than after 15 seconds.

**SNMP ID:**

2.70.12.2

**Telnet path:****Setup > IPv6 > Router > Dest.-Cache-Timeout****Possible values:**

Max. 3 characters

**Default:**

30 seconds

**9.6.12 IPv6 address**

Enter the IPv6 address of the station.

If a client needs to resolve the name of a station, it sends a request with that name to the DNS server. The server responds by communicating the IPv6 address entered here.

**SNMP ID:** 2.17.5.3

**Telnet path:** /Setup/DNS/DNS-List

**Possible values:**

- Valid IPv6 address.

**Default:** Blank

## 9.7 Additions to the Status menu

### 9.7.1 Log table

This table contains a list of all IPv6 firewall events.

**SNMP ID:**

1.77.9.1

**Telnet path:**

**Status > IPv6 > Firewall**

**Idx.**

Sequential index. Furthermore, the table can also be checked via SNMP.

**System time**

System time in UTC encoding (converted to plain text for display).

**Source address**

Source address of the filtered packet.

**Destination address**

Destination address of the filtered packet.

**Prot.**

Protocol (TCP, UDP, etc.) of the filtered packets.

**Source port**

Source port of the filtered packet (only for port related protocols).

**Destination port**

Destination port of the filtered packet (only for port related protocols).

**Filter rule**

Name of the rule that created the entry.

**Limit**

Bit field that contains the description of the limit that caused the firewall to apply the filter. There following values are currently defined:

- 0x01: Absolute number
- 0x02: Number per second
- 0x04: Number per minute

- 0x08: Number per hour:
- 0x10: Global limit
- 0x20: Byte limit (if not set, it is a packet limit)
- 0x40: Limit only applies in the inbound direction
- 0x80: Limit only applies in the outbound direction

### Threshold

Threshold limit value of the triggering limit.

### Action

Bit field which lists all the actions performed. The following values are currently defined:

- 0x00000001: Accept
- 0x00000100: Reject
- 0x00000200: Establish filter
- 0x00000400: Internet (default router) filter
- 0x00000800: Drop
- 0x00001000: Disconnect
- 0x00004000: Lock source address
- 0x00020000: Lock destination address and port
- 0x20000000: Send SYSLOG notification message
- 0x40000000: Send SNMP trap
- 0x80000000: Send e-mail

## 9.8 Additional command-line commands

Various IPv6 functions can be queried at the command line. The following command-line functions are available:

- *IPv6 addresses*: `show ipv6-addresses`
- *IPv6 prefixes*: `show ipv6-prefixes`
- *IPv6 interfaces*: `show ipv6-interfaces`
- *IPv6 neighbor cache*: `show ipv6-neighbor-cache`
- *IPv6 DHCP*: `show dhcp6-server`
- *IPv6 DHCP*: `show dhcpv6-client`
- *IPv6 route*: `show ipv6-route`

Additionally, IPv6 communications can be followed with the `trace` command.

### 9.8.1 IPv6 addresses

The command `show ipv6-addresses` shows a list of IPv6 addresses that are currently being used. This is sorted by interface. Note that an interface can have multiple IPv6 addresses. One of these addresses is always the link-local address, which starts with `fe80` :

The output is formatted as follows:

<Interface> :

<IPv6 address>, <status>, <attribute>, (<type>)

**Table 2: Components of the command-line output `show ipv6-addresses`:**

Output	Comment
Interface	The name of the interface
IPv6 address	The IPv6 address
Status	<p>The status field can contain the following values:</p> <ul style="list-style-type: none"> <li>■ TENTATIVE Duplicate Address Detection (DAD) is currently checking the address. It is not yet available for unicast.</li> <li>■ PREFERRED The address is valid</li> <li>■ DEPRECATED The address is still valid, but it is being discontinued. The optimal status for communication is PREFERRED.</li> <li>■ INVALID The address is invalid and cannot be used for communication. An address given this status after its lifetime has expired.</li> </ul>
Attribute	<p>Shows an attribute of the IPv6 address. Possible attributes are:</p> <ul style="list-style-type: none"> <li>■ None No special attributes</li> <li>■ (ANYCAST) This is an anycast address</li> <li>■ (AUTO CONFIG) The address was retrieved by auto-configuration</li> <li>■ (NO DAD PERFORMED) No DAD is performed</li> </ul>
Type	The type of IP address

## 9.8.2 IPv6 prefixes

The command `show ipv6-prefixes` displays all known prefixes. These are sorted according to the following criteria:

- **Delegated prefixes:** All prefixes that the router has obtained by delegation.
- **Advertised prefixes:** All prefixes that the router announces in its router advertisements.
- **Deprecated prefixes:** All prefixes that are being discontinued. These may still be functional, but they will be deleted after a certain time.

## 9.8.3 IPv6 interfaces

The command `show ipv6-interfaces` displays a list of IPv6 interfaces and their status.

The output is formatted as follows:

```
<Interface> : <Status>, <Forwarding>, <Firewall>
```

**Table 3: Components of the command-line output `show ipv6-interfaces`:**

Output	Comment
Interface	The name of the interface
Status	The status of the interface. Possible entries are: <ul style="list-style-type: none"> <li>oper status is up</li> <li>oper status is down</li> </ul>
Forwarding	The forwarding status of the interface. Possible entries are: <ul style="list-style-type: none"> <li>forwarding is enabled</li> <li>forwarding is disabled</li> </ul>
Firewall	The status of the firewall. Possible entries are: <ul style="list-style-type: none"> <li>forwarding is enabled</li> <li>firewall is disabled</li> </ul>

### 9.8.4 IPv6 neighbor cache

The command `show ipv6-neighbor-cache` displays the current neighbor cache.

The output is formatted as follows:

```
<IPv6 address> iface <interface> lladdr <MAC address> (<switch port>) <device type> <status> src <source>
```

**Table 4: Components of the command-line output `show ipv6-neighbor-cache`:**

Output	Comment
IPv6 address	The IPv6 address of the neighboring device
Interface	The interface where the neighbor is accessed
MAC address	The MAC address of the neighbor
Switch port	The switch port on which the neighbor was found
Device type	Neighbor's device type (host or router)
Status	The status of the connection to neighboring devices. Possible entries are: <ul style="list-style-type: none"> <li>INCOMPLETE <p>Resolution of the address was still in progress and the link-layer address of the neighbor was not yet determined.</p> </li> <li>REACHABLE <p>The neighbor was reached in the last ten seconds.</p> </li> <li>STALE <p>The neighbor is no longer qualified as REACHABLE, but an update will only be performed when an attempt is made to reach it.</p> </li> <li>DELAY <p>The neighbor is no longer qualified as REACHABLE, but data was recently sent to it; waiting for verification by other protocols.</p> </li> <li>PROBE <p>The neighbor is no longer qualified as REACHABLE. Neighbor solicitation probes are sent to it to confirm availability.</p> </li> </ul>
Source	The IPv6 address at which the neighbor was detected.

### 9.8.5 IPv6 DHCP server

The command `show dhcpv6-server` displays the current status of the DHCP server. The display includes information about the interface on which the server is active, which DNS server and prefixes it has, and what client preferences it has.

### 9.8.6 IPv6 DHCP client

The command `show dhcpv6-client` displays the current status of the DHCP client. The display includes information about the interface being used by the client and the prefixes and DNS server that it is using.

### 9.8.7 IPv6 route

The command `show ipv6-route` displays the complete IPv6 routing table. Routers with fixed entered routes are displayed with the suffix [static] and the dynamically obtained routes have the suffix [connected]. The loopback address is marked [loopback]. Other automatically generated addresses have the suffix [local].

### 9.8.8 Release IPv6 address

Command	Description
Release [-x] <Interface 1> ... <Interface n>	The DHCPv6 client returns its IPv6 address and/or its prefix to the DHCPv6 server. It then submits a new request for an address or prefix to the DHCPv6 server. Depending on the provider, the server assigns a new address to the client, or reassigns the previous one. Whether the client receives a different address or prefix is determined solely by the server.  The option switch <code>-x</code> suppresses the confirmation message.  The <code>*</code> wildcard applies the command on all of the interfaces and prefix delegations.

### 9.8.9 Ping command for IPv6

As of LCOS version 8.80, you can use the command `ping -6` (or the alias `ping6`) to send an ICMP ECHO\_REQUEST to a host on an IPv6 network.

For IPv6, the scope of parameters is of central importance: IPv6 requires a link-local address (`fe80::/10`) to be assigned to every network interface (logical or physical) on which the IPv6 protocol is enabled, so you must specify the scope when pinging a link-local address. This is the only way that the ping command knows which interface it should send the package to. A percent sign (%) separates the name of the interface from the IPv6 address.

#### Examples:

```
ping -6 fe80::1%INTRANET
```

Pings the link-local address "fe80::1", which can be reached via the interface or network "INTRANET".

```
ping -6 2001:db8::1
```

Pings the global IPv6 address '2001:db8::1'.

The meaning of the optional parameters is explained in the following table:

Parameters	Meaning
<code>-6 &lt;IPv6 address&gt;%&lt;scope&gt;</code>	Performs a ping command to the link-local address via the interface specified by <code>&lt;scope&gt;</code> .

### 9.8.10 Overview of parameters

 The traces available for a particular model can be displayed by entering `trace` without any arguments.



This parameter ...	...causes the following message in the trace:
Status	Connection status messages
Error	Connection error messages
IPX-Router	IPX routing
PPP	PPP protocol negotiation
SAP	IPX service advertising protocol
IPX-Watchdog	IPX watchdog spoofing
SPX-Watchdog	SPX watchdog spoofing
LCR	Least-cost router
Script	Script negotiation
IPX-RIP	IPX routing information protocol
Firewall	Displays firewall events
RIP	IP routing information protocol
ARP	Address resolution protocol
ICMP	Internet control message protocol
IP-Masquerading	Events in the masquerading module
DHCP	Dynamic host configuration protocol
NetBIOS	NetBIOS administration
DNS	Domain name service protocol
Pacet-Dump	Displays the first 64 bytes of a packet in hexadecimal
D-Channel-Dump	Traces the D channel of the ISDN bus connected
ATM-Cell	ATM packet level
ATM-Error	ATM error
ADSL	ADSL link status
SMTP-Client	Email processing with the integrated mail client
Mail-Client	Email processing with the integrated mail client
SNTP	Simple network time protocol
NTP	Timeserver trace
Connect	Messages from the activity protocol
Cron	Activities of the scheduler (cron table)
RADIUS	RADIUS trace
Serial	Information on the state of the serial interface
USB	Information on the state of the USB interface
Load-Balancer	Information on load balancing
VRRP	Information on the virtual router redundancy protocol
Ethernet	Information on the Ethernet interfaces
VLAN	Information on virtual networks
IGMP	Information on the internet group management protocol
WLAN	Information on activity in the wireless networks
IAPP	Trace on inter access point protocol giving information on wireless LAN roaming.

This parameter ...	...causes the following message in the trace:
DFS	Trace on dynamic frequency selection, automatic channel selection in the 5 GHz wireless LAN band
Bridge	Information on the wireless LAN bridge
EAP	Trace on EAP, the key negotiation protocol used with WPA/802.11i and 802.1x
Spgtree	Information on spanning tree protocol
LANAUTH	LAN authentication (e. g. Public Spot)
SIP-Packet	SIP information that is exchanged between a LANCOM VoIP router and a SIP provider or a upstream SIP telephone system
VPN-Status	IPSec and IKE negotiations
VPN-Packet	IPSec and IKE packets
XML-Interface-PbSpot	Messages from the Public Spot XML interface
IPv6-Config	Information on the IPv6 configuration
IPv6-Firewall	Events of the IPv6 firewall
IPv6-Interfaces	Information about the IPv6 interfaces
IPv6-LAN-Packet	Data packets over the IPv6 LAN connection
IPv6-Router	Information about the IPv6 routing
IPv6-WAN-Packet	Data packets over the IPv6 WAN connection

## 9.9 Enhancements to LANconfig

### 9.9.1 IPv6 configuration menu

Where previous versions provided configuration menus for TCP/IP for IPv4, you now find the options **IPv4** and **IPv6**.

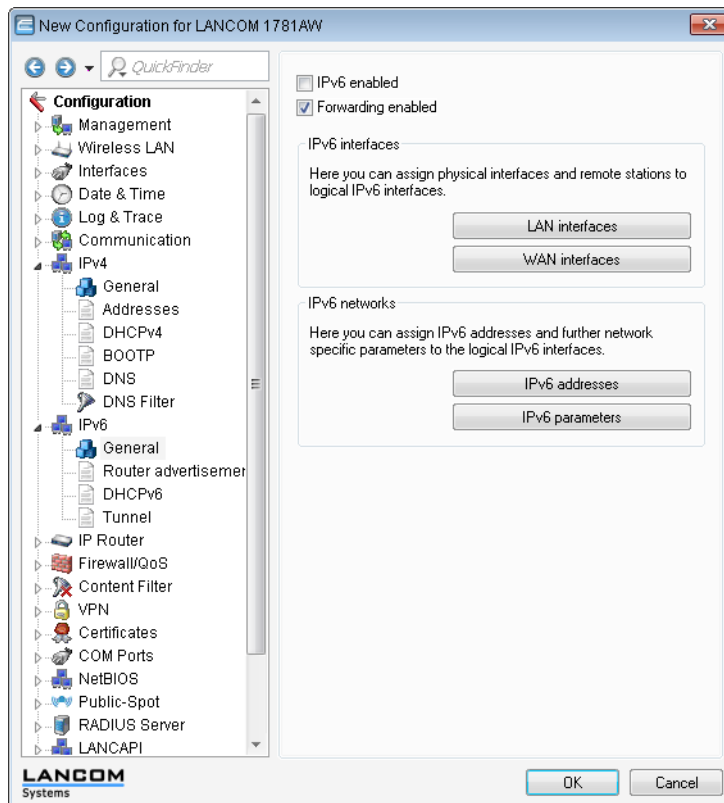

Click on **IPv6** to adjust the settings for this protocol. The configuration dialog **IPv6** is divided into the options **General**, **Router advertisement** and **Tunnel**. By default a click on **IPv6** takes you straight to the [General](#) options.

#### General

This is where you make the basic settings.

- **IPv6 enabled:** This is where you can enable or disable IPv6 for the device.

- **Forwarding enabled:** Forwarding is used for packet forwarding between IPv6 interfaces. This option is activated by default.

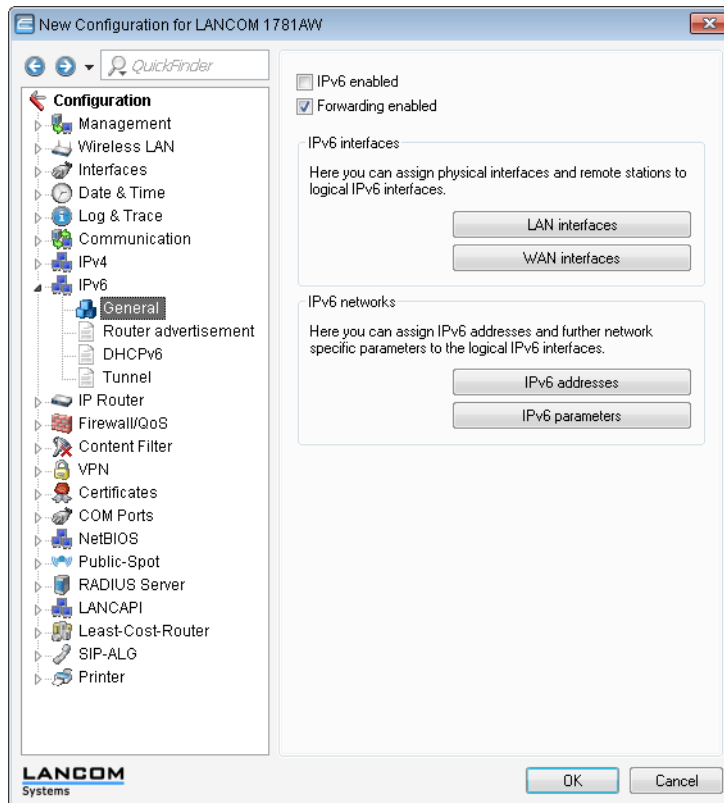

- The buttons **LAN interfaces** and **WAN interfaces** access the tables where you can add new interfaces, configure existing interfaces, or delete them.

This shows the table with a LAN interface:

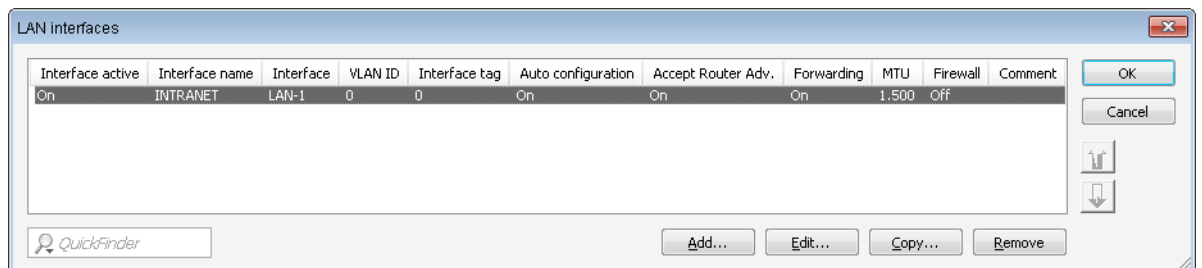

- The buttons **IPv6 addresses** and **IPv6 parameters** are used to assign IPv6 addresses to interfaces and to configure the interface parameters (gateway address, primary and secondary DNS).

## Router advertisement

The **Router advertisement** configuration provides you with four buttons for setting up the Neighbor Discovery Protocol (NDP) if the device is to operate as an IPv6 router:

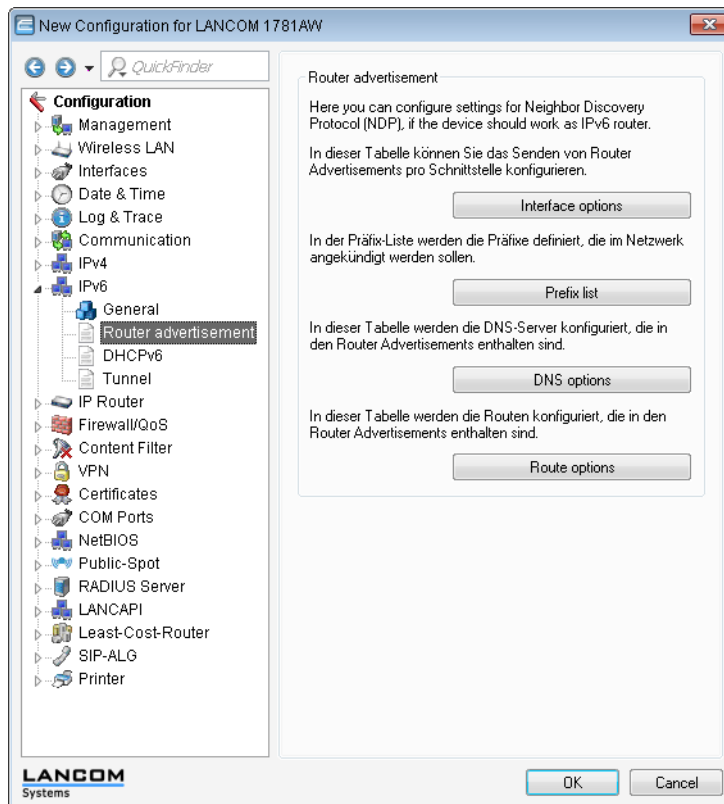

Each button opens a table with the settings for the corresponding function:

- **Interface options:** Enable or disable the following interface features:
  - **Send router advertisements:** Regulates the periodic transmission of router advertisements and the response to router solicitations.
  - **Managed address configuration flag:** With this function enabled, clients receiving this router advertisement will configure their addresses with Stateful Autoconfiguration (DHCPv6). Clients then automatically retrieve other information, such as the DNS server.
  - **Other flag:** If this function is active, a client will attempt to obtain additional information via DHCPv6, such as DNS server addresses.

For each prefix, you can specify whether or not a client should form addresses by auto-configuration: Navigate to the **Prefix list** under **Allow auto-configuration (SLAAC)**.

- **Default router:** Defines how the device advertises itself as the default gateway or router.

The parameters have the following functions:

- **"Automatic":** As long as a WAN connection exists, the device sends a positive router lifetime in the router advertisement messages. The result is that a client uses this router as the default gateway.  
If there is no WAN connection, the router sets the router lifetime to "0". A client then stops using this router as the default gateway.
- **"Always":** The router lifetime is always positive—i. e. greater than "0"—irrespective of the WAN connection status.
- **"Never":** The router lifetime is always "0".
- **Router priority:** Defines the preference of this router. Clients enter this preference into their local routing tables.

- **Prefix list:** Set the prefix options for the interfaces that are being used. The following settings are possible:
  - **Prefix:** Enter a prefix that is announced in the router advertisements, e. g. "2001:db8::/64". The prefix length must always be exactly "/64", otherwise it will be impossible for clients to generate their addresses by adding their interface identifiers (with a length of 64 bits). If a prefix delegated by the provider is to be propagated automatically, set "::/64" here and enter the name of the corresponding WAN interface as the parameter **Receive prefix from**.
  - **Subnet ID:** Here you enter the subnet ID that is to be combined with the prefix delegated by the provider. If the provider assigns the prefix "2001:db8:a::/48", for example, and the subnet ID is "0001" (or "1" for short), then the router advertisement on this interface is given the prefix "2001:db8:a:0001::/64". The maximum subnet length with a 48-bit long delegated prefix is 16 bits (i.e. 65,536 subnets), with available subnet IDs ranging from "0000" to "FFFF". With a delegated prefix of "/56", the maximum subnet length is 8 bits (i.e. 256 subnets) with subnet IDs ranging from "00" to "FF". In general, the subnet ID "0" is used when the WAN IPv6 address is formed automatically. This is why subnet IDs for LANs start at "1". The default setting is '1'.
  - **Allow auto configuration (SLAAC):** Specifies whether the prefix is to be used for a stateless address autoconfiguration (SLAAC). The default setting is "enabled".
  - **Receive prefix from:** Defines the name of the interface used to receive a prefix via DHCPv6 prefix delegation or via a tunnel. This prefix can be used to derive and propagate a subnet for each interface.
- **DNS options:** Defines the DNS information in router advertisements according to RFC 6106. The following settings are possible:
  - **Interface name:** Name of the interface on which the IPv6 DNS server announces information in router advertisements.
  - **Primary DNS:** IPv6 address of the first IPv6 DNS server (recursive DNS server, RDNSS, according to RFC 6106) for this interface.
  - **Secondary DNS:** IPv6 address of the secondary IPv6 DNS server for this interface.
  - **Import DNS search list from the internal DNS server:** Indicates whether the DNS search list or the own domain for this logical network should be inserted from the internal DNS server, e.g., "internal". The own domain can be configured under **IPv4 > DNS > General settings**. The default setting is "enabled".
  - **Import DNS search list from WAN:** Specifies whether the DNS search list sent by the provider (e.g., provider-xy.de) is announced in this logical network. This feature is available only if the prefix list is connected to the corresponding WAN interface under **Receive prefix from**.
- **Route options:** Defines the route option in router advertisements according to RFC 4191 (Route Information Option). The following settings are possible:
  - **Interface name:** Defines the name of the logical interface to be used for sending router advertisements with this route option.
  - **Prefix:** Prefix of the route option, e.g. "2001:db8::/32".
  - **Route preference:** Preferred route. Possible values are "high", "medium" (default) and "low".

## DHCPv6

This is where you configure the DHCPv6 server, the DHCPv6 client and the DHCPv6 relay agent.

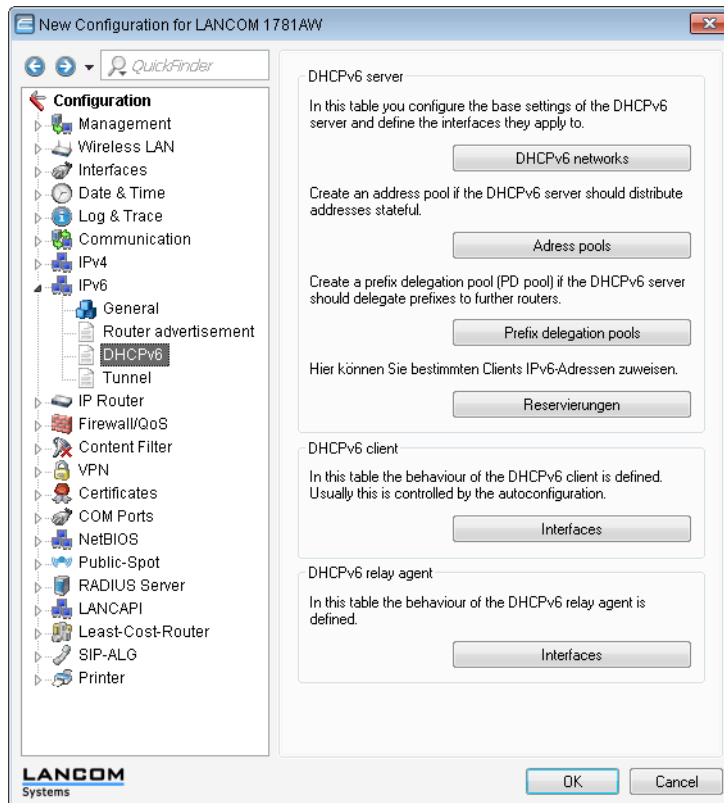

### DHCPv6 server

Use the following buttons to access the tables and adjust the respective functions:

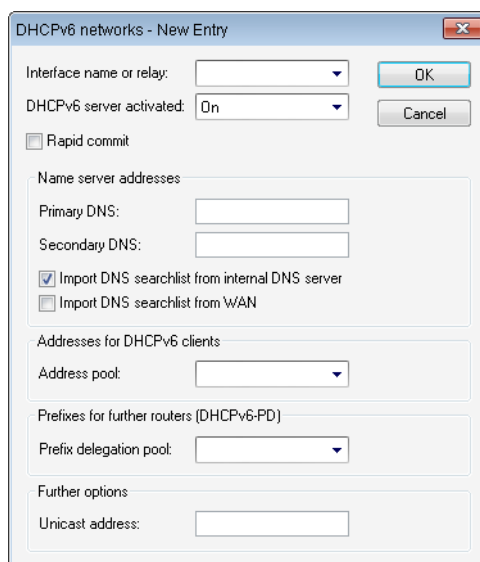

- DHCPv6 networks:** This table is used to configure the basic settings of the DHCPv6 server, and to specify which interfaces they apply to.

- **Interface name or relay:** Name of the interface on which the DHCPv6 server is working, e.g. "INTRANET". Alternatively, you can also enter the IPv6 address of the remote DHCPv6 relay agent.
- **DHCPv6 server activated:** Activates or deactivates the entry.
- **Rapid commit:** With rapid commit activated, the DHCPv6 server responds directly to a solicit message with a reply message.

! The client must explicitly include the rapid commit option in its solicit message.

- **Primary DNS:** IPv6 address of the primary DNS server.
- **Secondary DNS:** IPv6 address of the secondary DNS server.
- **Import DNS search list from the internal DNS server:** Indicates whether the DNS search list or the own domain for this logical network should be inserted from the internal DNS server, e.g., "internal". The own domain can be configured under **IPv4 > DNS > General settings**. The default setting is "enabled".
- **Import DNS search list from WAN:** Specifies whether the DNS search list from the provider (e.g., provider-xy.com) is announced on this logical network. The default setting is "disabled".
- **Address pool:** Name of the address pool used for this interface.

! If the DHCPv6 server operates 'stateful' addresses distribution, you must enter the corresponding addresses into the **Address pools** table.

- **Prefix delegation pool:** Name of prefix pools to be used by the DHCPv6 server.

! If the DHCPv6 server is to delegate prefixes to other routers, you must enter the corresponding prefixes in the table **Prefix delegation pools**.

- **Unicast address:** By default the DHCPv6 server exclusively responds to multicast requests. If the DHCPv6 server should respond to a unicast request, this IPv6 address can be configured here. Generally speaking, multicast is sufficient for communication.

- **Address pools:** If distribution of the DHCPv6 server is to be stateful, this table defines an address pool:

The screenshot shows a dialog box titled "Address pools - New Entry". It has the following fields and controls:

- Address pool name:** A text input field.
- First address:** A text input field with a double colon (::) as a placeholder.
- Last address:** A text input field with a double colon (::) as a placeholder.
- Preferred lifetime:** A text input field containing "3.600" and a "seconds" label.
- Valid lifetime:** A text input field containing "86.400" and a "seconds" label.
- Receive prefix from:** A dropdown menu.
- Buttons:** "OK" and "Cancel" buttons.

- **Address pool name:** Name of the address pool
- **First address:** First address in the pool, e.g., "2001:db8::1"
- **Last address:** Last address in the pool, e.g., "2001:db8::9"
- **Preferred lifetime:** Here you specify the time in seconds that the client should treat this address as "preferred". After this time elapses, a client classifies this address as "deprecated".
- **Valid lifetime:** Here you specify the time in seconds that the client should treat this address as "valid".

! If you use a prefix from a WAN interface for dynamic address formation, you cannot configure values for **preferred lifetime** and **valid lifetime**. In this case, the device automatically determines the values that apply to the prefix delegated by the provider.

- **Receive prefix from:** With this parameter you can assign addresses to the network clients from the prefix that the router retrieved from the WAN interface via DHCPv6 prefix delegation. Select the desired WAN interface here. For example, if the provider assigned the prefix "2001:db8::/64", you can then enter the value "::1" in the parameter **First address** and "::9" in **Last address**. In combination with the prefix "2001:db8::/64" as delegated by the provider, the clients receive addresses from the pool "2001:db8::1" to "2001:db8::9".

If the provider prefix is greater than "/64", e.g., "/48" or "56", you must take subnetting for the logical network in to account in the address.



**Example:**

- Assigned provider prefix: "2001:db8:abcd:aa::/56"
- "/64" as the prefix of the logical network (subnet ID 1): "2001:db8:abcd:aa01::/64"
- First address: "0:0:0:0001::1"
- Last address: "0:0:0:0001::9"



You should only use this mechanism if the provider assigns a fixed prefix. Otherwise, it is possible that the provider delegates a new prefix to the router, but the client still has an address from the pool with the old prefix. In this case, the client must update its address at the server.

- Prefix delegation pools:** In this table, you specify the prefixes that the DHCPv6 server delegates to other routers:

- PD pool name:** Name of the PD pool
- First prefix:** First prefix to be delegated in the PD pool, e.g., "2001:db8:1100::"
- Last prefix:** Last prefix to be delegated in the PD pool, e.g., "2001:db8:FF00::"
- Prefix length:** Length of the prefixes in the PD pool, e.g., "56" or "60"
- Preferred lifetime:** Here you specify the time in seconds that the client should treat this prefix as "preferred". After this time elapses, a client classifies this address as "deprecated".
- Valid lifetime:** Here you specify the time in seconds that the client should treat this prefix as "valid".



If you use a prefix from a WAN interface for dynamic address formation, you cannot configure values for preferred lifetime and valid lifetime. In this case, the device automatically determines the values that apply to the prefix delegated by the provider.

- Receive prefix from:** Name of the WAN interface from which the client should use the prefix to form the address or prefix.
- Reservations:** If you want to assign fixed IPv6 addresses to clients, you can make a reservation for each client in this table:

- Interface name or relay:** Name of the interfaces on which the DHCPv6 server is working, e.g., "INTRANET". Alternatively, you can also enter the IPv6 address of the remote relay agent.
- Address/PD-Prefix:** IPv6 address, or PD prefix that you want to assign statically.
- Client ID:** DHCPv6 unique identifier (DUID) of the client.

DHCPv6 clients are no longer identified with their MAC addresses like DHCPv4 clients, they are identified with their DUID instead. The DUID can be read from the respective client, for example, on Windows with the shell command `ipconfig /all` or in WEBconfig under **Status > IPv6 > DHCPv6 > Client > Client ID**.

For devices working as a DHCPv6 server, the client IDs for clients that are currently using retrieved IPv6 addresses are to be found under **Status > IPv6 > DHCPv6 > Server > Address bindings**, and retrieved IPv6 prefixes are under **Status > IPv6 > DHCPv6 > Server > PD bindings**.

LANmonitor displays that client IDs under **DHCPv6 server**.

- **Preferred lifetime:** Here you specify the time in seconds that the client should treat this address as "preferred". After this time elapses, a client classifies this address as "deprecated".
- **Valid lifetime:** Here you specify the time in seconds that the client should treat this address as "valid".

! If you use a prefix from a WAN interface for dynamic address formation, you cannot configure values for `preferred lifetime` and `valid lifetime`. In this case, the device automatically determines the values that apply to the prefix delegated by the provider.

- **Receive prefix from:** Name of the WAN interface from which the client should use the prefix to form the address or prefix.

### DHCPv6 client

Use the following buttons to access the tables and adjust the respective functions:

- **Interfaces:** This table determines the behavior of the DHCPv6 client.

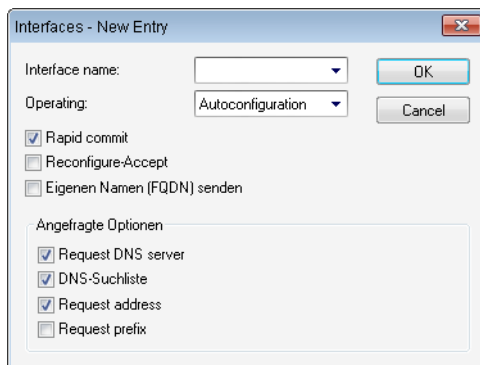

! Normally client behavior is controlled by the auto-configuration. Only make entries in this table if you want to use the client in "stand-alone" mode or if there are other specific options that deviate from the default settings.

- **Interface name:** Name of the interface on which the DHCPv6 client is working. These can be LAN interfaces or WAN interfaces (remote stations), e.g. "INTRANET" or "INTERNET".
- **Operating:** Determines if and how the device enables the client. Possible values are:
  - "Autoconfiguration": The device waits for router advertisements, and then starts the DHCPv6 client. This option is the default setting.
  - "Yes": The device starts the DHCPv6 client as soon as the interface is active, without waiting for router advertisements. The device ignores the specifications from router advertisements.
  - "No": The DHCPv6 client is disabled on this interface. Even if the device receives router advertisements, it will not start the client.
- **Rapid commit:** When rapid commit is activated, the client attempts to obtain an IPv6 address from the DHCPv6 server with just two messages. If the DHCPv6 server is configured correspondingly, it immediately responds to this solicit message with a reply message.
- **Reconfigure accept:** If the client successfully negotiates a re-configuration (reconfigure) with the server during first contact, the server can request the client to update its address or other information at any time. The mechanism

is protected by the so-called 'Reconfigure Key', so that only the original server with the correct key can make requests to the client. If the client receives a reconfigure message without a valid reconfigure key, the client rejects this invocation.

The client supports the "Reconfigure Key Authentication Protocol" according to RFC 3315 for the options "Renew" and "Information Request", and also "Rebind" as per RFC 6644.

This option is enabled by default for WAN interfaces.

- **Send own name (FQDN):** The client sends its own host name (Fully Qualified Domain Name). By default, this option is active on LAN interfaces.
- **Request DNS server:** Specifies whether the client queries the DHCPv6 server for DNS servers.



You must enable this option in order for the device to obtain information about a DNS server.

- **DNS search list:** The client queries the DNS search list.
- **Request address:** Determines whether the client should request an IPv6 address from the DHCPv6 server.



Only activate this option if addresses configured by the DHCPv6 server via this interface are stateful, i. e. not distributed by 'SLAAC'.

- **Request prefix:** Determines whether the client should request an IPv6 prefix from the DHCPv6 server. Activating this option is only necessary if the device itself functions as a router and redistributes these prefixes. This option is enabled by default on WAN interfaces in order for the DHCPv6 client to request a prefix from the provider for use in its local network. This option is disabled by default on LAN interfaces because devices in a local network are more likely to function as clients rather than as routers.

### DHCPv6 relay agent

Use the following buttons to access the tables and adjust the respective functions:

- **Interfaces:** A DHCPv6 relay agent forwards DHCP messages between DHCPv6 clients and DHCPv6 servers, which are located in different networks. This table determines the behavior of the DHCPv6 relay agent.

- **Interface name:** Name of the interface on which the relay agent receives requests from DHCPv6 clients, e.g. "INTRANET".
- **DHCPv6-Relay-Agent-enabled:** Determines if and how the device enables the relay agent. Possible values are:
  - "Yes": Relay agent is enabled. This option is the default setting.
  - "No": Relay agent is not enabled.
- **Interface address:** The relay agent's own IPv6 address on the interface that is configured under Interface name. This IPv6 address is used as a sender address in DHCP messages that are forwarded. This sender address enables DHCPv6 clients to uniquely identify a relay agent. An explicit specification of the interface address is necessary because an IPv6 host can have multiple IPv6 addresses for each interface.
- **Destination address:** The IPv6 address of the (destination) DHCPv6 server which the relay agent should forward DHCP requests to. The address can be either a unicast or link-local multicast address. When using a link-local

multicast address, you must specify the destination interface where the DHCPv6 server is to be reached. All DHCPv6 servers and relay agents are available at the link-local multicast address ff02::1:2.

- Destination interface:** The destination interface where the parent DHCPv6 server or the next relay agent can be reached. This information is essential if a link-local multicast address is configured under the destination address, as link local-multicast addresses are only valid at that respective link.

## Tunnel

The **Tunnel** configuration offers you 3 buttons to create IPv6 tunnels that can be used over IPv4 networks. Use these options to gain access to the IPv6 Internet using an IPv4 connection.

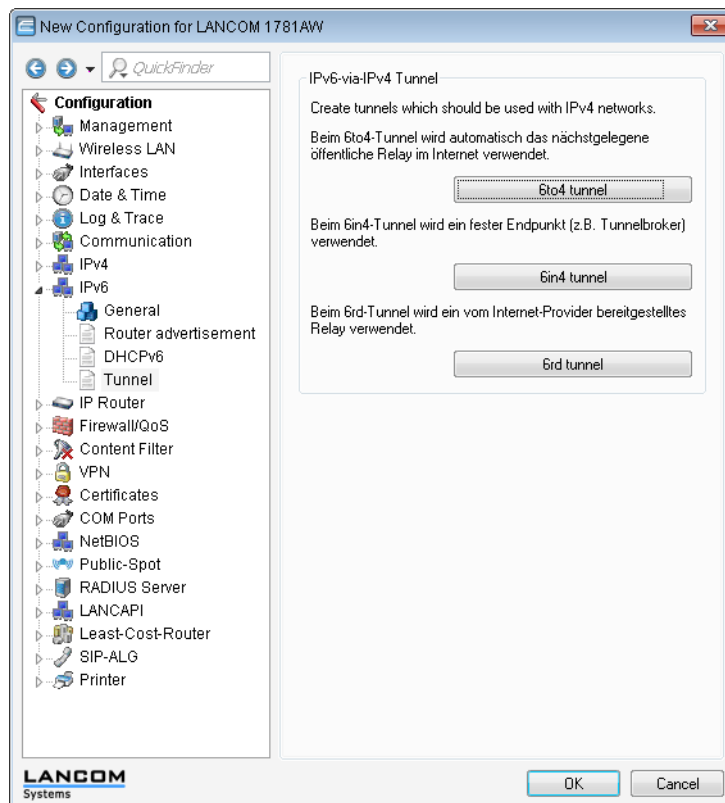

- 6to4 tunnel:** This button opens the 6to4 tunnel settings.

⚠ Connections through a 6to4 tunnel work with relays that are selected by the IPv4 Internet provider's backbone. The device administrator has no influence on relay selection. Furthermore, the selected relay can change without the administrator knowing about it. For this reason, connections via a 6to4 tunnels are suitable **for test purposes only**. In particular, avoid using 6to4-tunnel data connections for productive systems or for the transmission of confidential data.

- 6in4 tunnel:** This button opens the 6in4 tunnel settings.

⚠ 6in4 tunnels require more administrative effort, but they represent a secure and stable technology for IPv6 Internet access. This option is also suitable for professional use.

- 6rd tunnel:** This button opens the 6rd tunnel settings.

⚠ 6rd tunneling is suitable for end users and for professional applications because configuration is less complex than with 6in4 tunneling and the technology avoids the security risks of 6to4 tunneling.

### 9.9.2 Settings in the PPP list

In the PPP list, you are able to specify you own definition of PPP negotiation for every remote site contacting your network.

You can also specify whether communications should use an IPv4 or an IPv6 connection.

The authentication of point-to-point connections in the WAN commonly relies on one of the protocols PAP, CHAP, MSCHAP or MSCHAPv2. The protocols here have a "hierarchy" amongst themselves, i.e. MSCHAPv2 is a "higher-level" protocol than MSCHAP, CHAP and PAP (higher protocols provide higher security). Many dial-in routers at Internet providers allow up-front authentication using a higher-level protocol such as CHAP, but only support the use of PAP further down the line. If the setting for the protocol for authentication is fixed in the LANCOM, the connection may fail because no common authentication protocol can be negotiated.

**!** In principle authentication can be repeated while the connection is being negotiated. Another protocol can be selected if, for example, it can only be recognized from the username at the earliest. However, this repeat negotiation is not supported in all scenarios. In particular when dialing in over UMTS, the device must explicitly refuse the provider's request for CHAP to be able to provide PAP user data for requests to be forwarded by the provider.

A flexible setting for the authentication protocols in the device ensures that the PPP connection is established as required. In addition, one or more protocols can be defined that are accepted for authentication of remote sites in the device (inbound connections) and on login of the device into other remote sites (outbound connections).

- When establishing inbound connections, the device requires the lowest of the permitted protocols, but where possible it also permits the remote site to use one of the higher-level protocols (enabled in the device).
- When establishing outbound connections, the device offers all enabled protocols, but only permits a selection from precisely these protocols. It is not possible to negotiate one of the disabled, possibly higher-level, protocols.

The PPP authentication protocols are set in the PPP list.

LANconfig: **Communication > Protocols > PPP list**

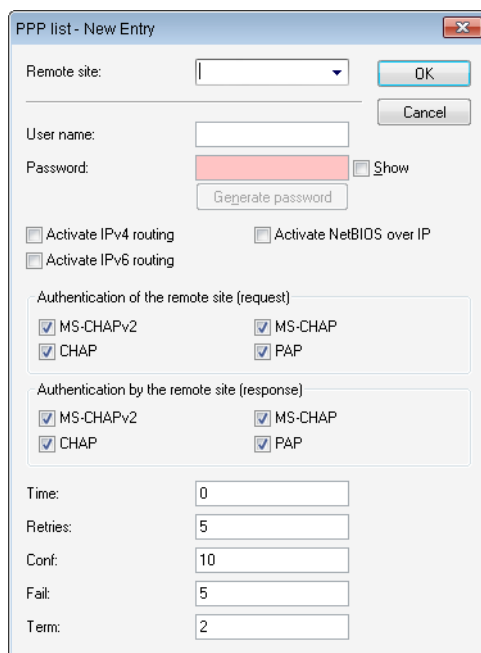

### 9.9.3 IP routing tables

Unlike previous versions where the configuration menu contained just a single IP routing table, this item now offers the configuration of separate routing tables for IPv4 and IPv6 connections.

You will find the new table under **IP router > Routing > IPv6 routing table**

The IPv4 settings that were previously in the table **IP routing table** are now located in the **IPv4 routing table** .

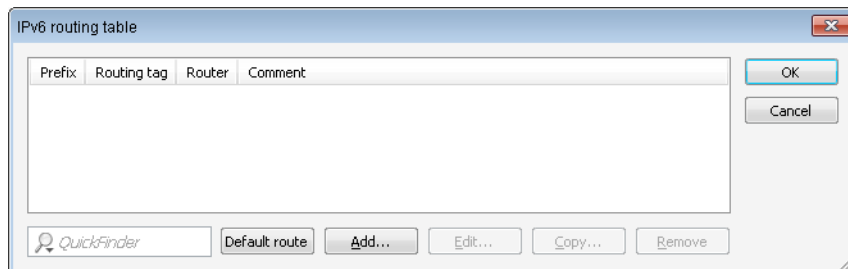
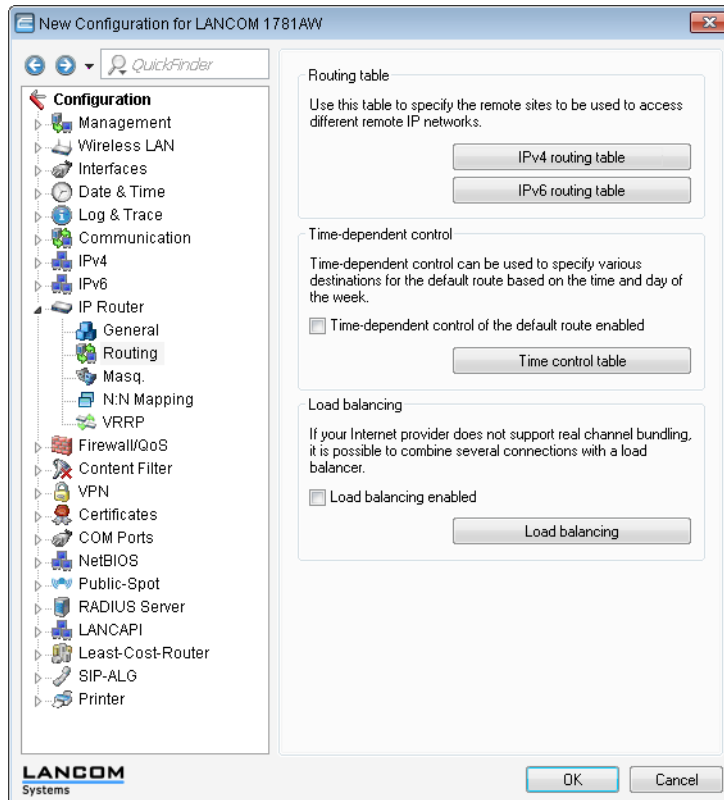

The table contains the entries to be used for routing packets with IPv6 addresses.

#### Prefix

Specify the prefix of the network area for which the data is to be routed to the given remote station.

#### Routing tag

Specify the routing tag for this route. This route is active only for packets with the same tag. The data packets receive the routing tag either from the firewall or depending on the LAN or WAN interface used.

#### Router

This is where you specify the remote site for this route.

#### Comment

Enter a descriptive comment for this entry.



Entering a comment is optional.

## 9.9.4 Separate views for the IPv4 and IPv6 firewalls

As of LCOS version 8.80, you can configure the rules for the IPv4 and IPv6 firewalls in separate views.

The corresponding configurations are located under **Firewall/QoS > IPv4 rules** and **Firewall/QoS > IPv6 rules** respectively.

## 9.9.5 IPv6 DNS hosts in the DNS list

When the DNS server in your device receives a query about a station name, it responds with the IP address contained in the Host names list. For each station/host name you define either the IPv4 or the IPv6 address, or alternatively you can enter both IP addresses.

In LANconfig, the table with the station names and the associated IP addresses is under **IPv4 > DNS > Host names**.

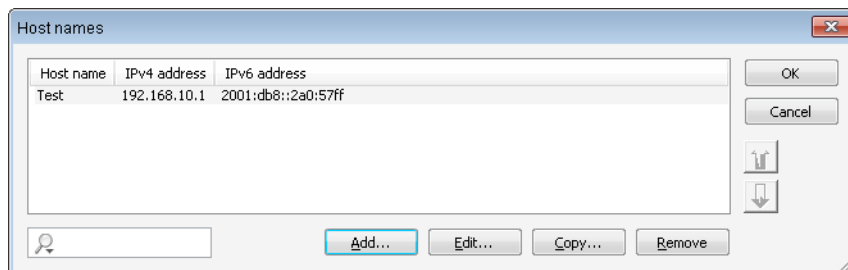

## 9.9.6 Configuring the IPv6 firewall rules

With LANconfig you can set the firewall rules under **Firewall/QoS > IPv6 Rules**.

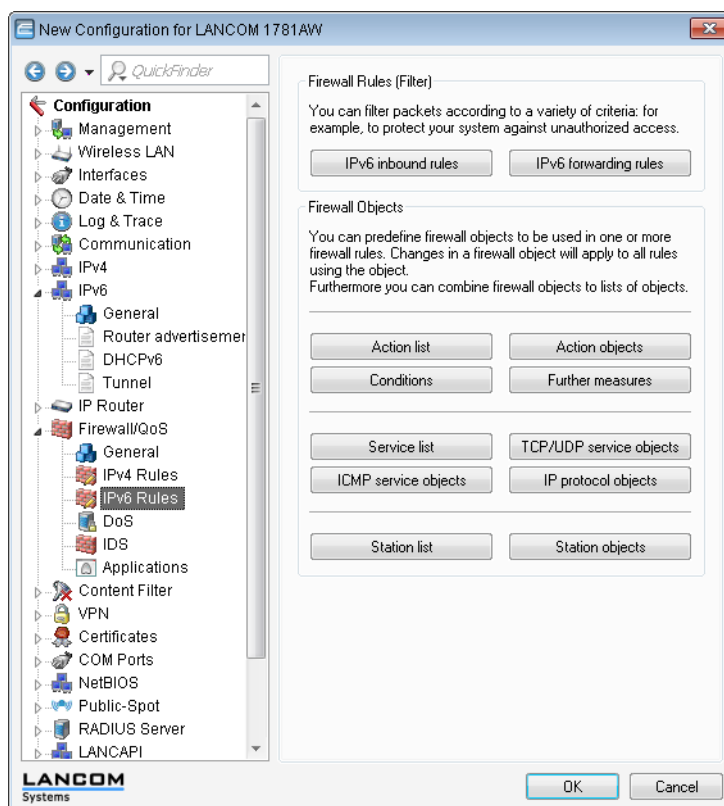

The factory settings provide various objects and lists for the most important applications.

! You cannot delete objects or lists if the firewall uses them in a forwarding or inbound rule.

## IPv6 inbound rules

Using the **IPv6 inbound rules** you set the rules that the IPv6 firewall should use to handle incoming traffic.

The factory settings provide various rules for the most important applications.

Click on **Add...** to create a new rule.

You can set the following properties for the rule:

### Name

Specifies the name of the rule.

### This rule is active for the firewall

Enables the rule.

### Priority

Specifies the priority of the rule: The higher the value, the higher the priority.

### Actions

Specifies the action that the firewall performs if the rule condition is true. Using **Select** you can choose one action or a list of actions.

Value	Source	Configuration path
<b>Action list [Name] (Firewall/QoS / IPv6 Rules / Firewall Objects) (0)</b>		
<input type="checkbox"/> Use 'Manage source...' to create valu...	Action list [Name]	Firewall/QoS / IPv6 Rules / Firewall Objects
<b>Action objects [Name] (Firewall/QoS / IPv6 Rules / Firewall Objects) (10)</b>		
<input type="checkbox"/> ACCEPT	Action objects [Name]	Firewall/QoS / IPv6 Rules / Firewall Objects
<input type="checkbox"/> ACCEPT-VPN	Action objects [Name]	Firewall/QoS / IPv6 Rules / Firewall Objects
<input type="checkbox"/> DROP	Action objects [Name]	Firewall/QoS / IPv6 Rules / Firewall Objects
<input type="checkbox"/> NO-CONNECT	Action objects [Name]	Firewall/QoS / IPv6 Rules / Firewall Objects
<input type="checkbox"/> NO-INTERNET	Action objects [Name]	Firewall/QoS / IPv6 Rules / Firewall Objects
<input checked="" type="checkbox"/> REJECT	Action objects [Name]	Firewall/QoS / IPv6 Rules / Firewall Objects
<input type="checkbox"/> REJECT-SNMP	Action objects [Name]	Firewall/QoS / IPv6 Rules / Firewall Objects

If you make a new entry here, it initially appears under **Unknown source**. Next, highlight the entry for a source that you want to assign to the new entry, and click on **Manage source**. Set the values for this entry, and save the new object. The new entry now appears as a new object in the list of the corresponding source.

### Server services

Determines the services which the firewall applies this rule to. Using **Select** you can choose one service or a list of services.



### Source stations

Determines the source stations which the firewall applies this rule to. Using **Select** you can choose one station or a list of stations.

### Comment

Here you assign a meaningful description for the filter rule.

## IPv6 forwarding rules

The **IPv6 forwarding rules** button accesses dialog where you set the rules that the IPv6 firewall should use to handle forwarded traffic.

The factory settings provide various rules for the most important applications.

In order to change the order of the rules, highlight the specific rule in the table and move it up or down in the table by clicking on the arrow buttons. The firewall applies the rules one after the other from top to bottom.

Click on **Add...** to create a new rule.

IPv6 forwarding rules - New Entry

Filter rules can be used to transfer or drop data packets according to specified criteria.

Name:

This rule is active for the firewall

Observe further rules, after this rule matches

This rule tracks connection states (recommended)

Priority:

Routing tag:

Actions:

Services:

Source stations:

Target stations:

Comment:

You can set the following properties for the rule:

### Name

Specifies the name of the rule.

### This rule is active for the firewall

Enables the rule.

### Observe further rules after this one matches

If you enable this option, the firewall also applies the subsequent rules in the list. This is useful if the firewall should, for example, initially apply a group rule and then apply each rule to the individual objects in the group.

### This rule tracks connection states (recommended)

Select this option if the rule should track the TCP connection states.

### Priority

Specifies the priority of the rule: The higher the value, the higher the priority.

### Routing tag

The interface tag that you enter here is a value that uniquely identifies the network. All packets received by this device on this network will be internally marked with this tag. The interface tag makes it possible to separate the rules valid for this network.

## Actions

Specifies the action that the firewall performs if the rule condition is true. Using **Select** you can choose one action or a list of actions.

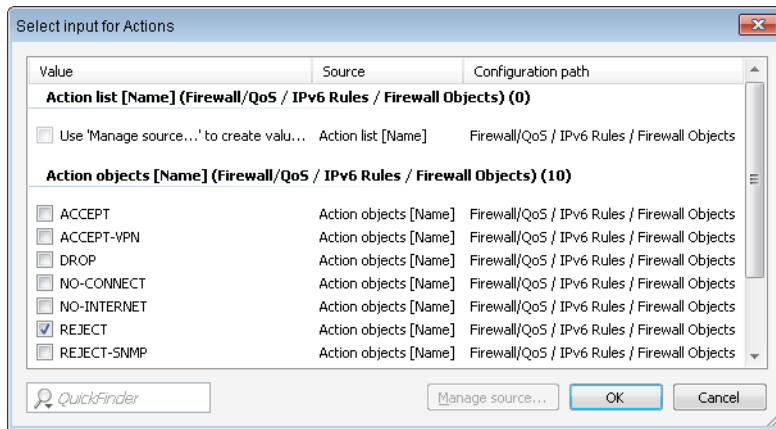

If you make a new entry here, it initially appears under **Unknown source**. Next, highlight the entry for a source that you want to assign to the new entry, and click on **Manage source**. Set the values for this entry, and save the new object. The new entry now appears as a new object in the list of the corresponding source.

## Server services

Determines the services which the firewall applies this rule to. Using **Select** you can choose one service or a list of services.

## Source stations

Determines the source stations which the firewall applies this rule to. Using **Select** you can choose one station or a list of stations.

## Target stations

Determines the target stations which the firewall applies this rule to. Using **Select** you can choose one station or a list of stations.

## Comment

Here you assign a meaningful description for the filter rule.

## Action list

Using the **Action list** button, you can collect actions into groups. The actions available here must first be defined using **Action objects**.

Click on **Add...** to create a new rule.

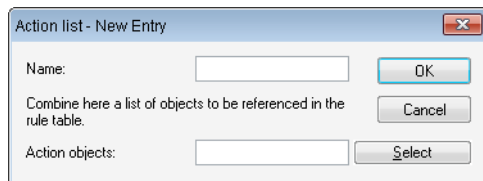

You can set the following properties for a list:

### Name

Determines the name of the list.

## Action objects

Determines the objects that you want to combine in this list. Using **Select** you can choose one or more objects from a list.

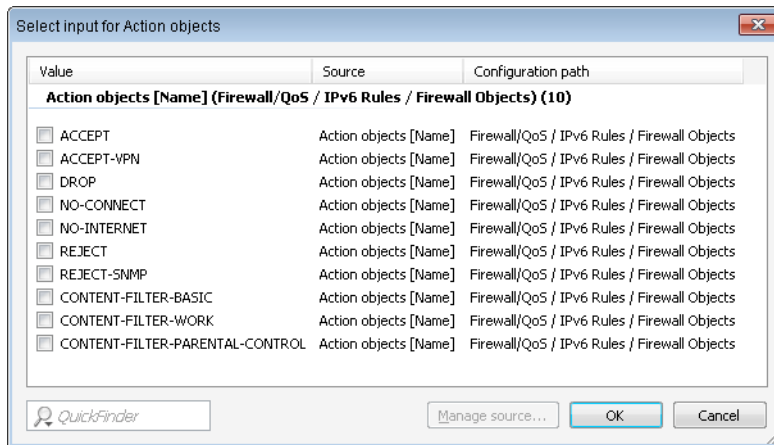

If you make a new entry here, it initially appears under **Unknown source**. Next, highlight the entry for a source that you want to assign to the new entry, and click on **Manage source**. Set the values for this entry, and save the new object. The new entry now appears as a new object in the list of the corresponding source.

## Action objects

Using the **Action objects** button, you define actions that the IPv6 firewall runs when a filter is true.

Click on **Add...** to create a new action.

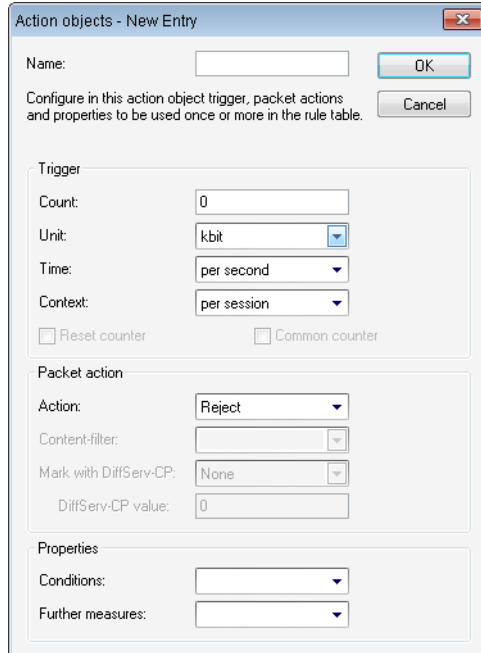

You can set the following properties for the object:

### Name

Specifies the name of the object.

### Count

When this limit is exceeded, the firewall performs the action.

**Unit**

Determines the unit for the limits. Select the corresponding value in the drop-down menu.

**Time**

Determines the measurement period that the firewall applies to the limit. Select the corresponding value in the drop-down menu.

**Context**

Determines the context that the firewall applies to the limit. Select the corresponding value in the drop-down menu.

**Reset counter**

If you enable this option, the firewall resets the counter after running the action.

---

 You can only activate this option if you selected "absolute" in the **time** value.

**Common counter**

If you enable this option, the firewall adds all action triggers together in one counter.

---

 You can only activate this option if you selected "per station" or "global" in the **Context** value.

**Action**

Determines the action the firewall performs when the limit is reached.

The following options are possible:

- **Reject:** The firewall rejects the data packet and sends an appropriate notification to the sender.
- **Drop:** The firewall discards the data packet without notification.
- **Transmit:** The Firewall accepts the data packet.

**Mark with DiffServ-CP**

Determines the priority of the data packets (differentiated services, DiffServ), with which the firewall should transfer the data packets.

---

 You can only activate this option if you selected "transmit" in the **Action** value.

---

 Further information about DiffServ CodePoints is available in the Reference Manual under the section "QoS".

**DiffServ-CP value**

Determines the value for the Differentiated Services Code Point (DSCP).

---

 You can only activate this option if you selected "Value" in **Mark with DiffServ-CP**.

**Conditions**

Determines which conditions must be met in order for the action to be performed. The item **Conditions** is used to specify any conditions.

**Further measures**

Determines which trigger actions the firewall should start in addition to filtering the data packets. You can specify trigger actions under the **Further measures**.

**Conditions**

Use the **Conditions** button to specify the conditions that have to be met for the forwarding and inbound rules to apply.

Click on **Add...** to create a new condition.

You can set the following properties for the condition:

### Name

Specifies the name of the object.

### Action only – if not connected

Select this option if the firewall should only perform the action if there is no connection.

### Action only – for default route (e.g. Internet)

Select this option if the firewall should only perform the action if there is a connection over the default route.

### Action only – for backup connections

Select this option if the firewall should only perform the action if the connection is a backup connection.

### Action only – for VPN route

Select this option if the firewall should only perform the action if the connection is a VPN connection.

### Action only – for packets sent

Select this option if the firewall should only perform the action for packets sent.

### Action only – for packets received

Select this option if the firewall should only perform the action for packets received.

### Transmission direction

Determines whether the transport direction refers to the logical connection or the physical data transmission over the respective interface.

### Action only – for DiffServ-CP

Determines the priority that the data packets (differentiated services, DiffServ) have to have, so that the condition is met.



Further information about DiffServ CodePoints is available in the Reference Manual under the section "QoS".

### DiffServ-CP value

Determines the value for the Differentiated Services Code Point (DSCP).

Enter a value here if you selected the "Value" option in the – **for DiffServ-CP** field.



Further information about DiffServ CodePoints is available in the Reference Manual under the section "QoS".

## Further measures

Use the **Further measures** button to define further measures that the firewall performs after you apply the forwarding and inbound rules.

Click on **Add...** to create a new measure.

You can set the following properties for the trigger actions:

### Name

Specifies the name of the object.

### SNMP (e.g. LANmonitor)

Select this option if the firewall should send a notification via SNMP. You can receive this notification, e.g., with LANmonitor.

### Send SYSLOG message

Select this option if the firewall should send a SYSLOG notification via SNMP.

! For more information about SYSLOG, refer to the chapter "Diagnostics" in the section "SYSLOG" in the Reference Guide.

### Send e-mail message

Select this option, if the firewall should send a notification by e-mail.

! If you want to receive e-mail notifications, you must enter an e-mail address in **Firewall/QoS > General > Administrator e-mail**.

### Disconnect

Select this option if the firewall should disconnect.

### Lock source address

Select this option if the firewall should block the source address. The firewall registers the blocked IP address, the lockout period, as well as the underlying rule in the **Host-lock-list** under **Status > IPv6 > Firewall**.

### Duration

If the firewall should block the sender, you can set the duration of the lock in minutes. The value "0" disables the lock because, in practice, the lockout period expires after 0 minutes.

### Close destination port

Select this option, if the firewall should block the target port. The firewall registers the blocked destination IP address, the protocol, the destination port, the lockout period, as well as the underlying rule in the **Port-block-list** under **Status > IPv6 > Firewall**.

## Duration

If the firewall should block the target port, you can set the duration of the lock in minutes. The value "0" disables the lock because, in practice, the lockout period expires after 0 minutes.

## Service list

Using the **Service list** button, you can collect services into groups. You first define the services under **TCP/UDP service objects**, **ICMP service objects** and **IP protocol objects**.

Click on **Add...** to specify a new service.

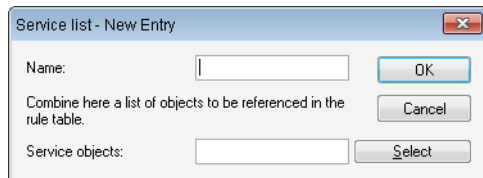

You can set the following properties for a list:

### Name

Determines the name of the list.

### Service objects

Determines the objects that you want to combine in this list. Using **Select** you can choose one or more objects from a list.

If you make a new entry here, it initially appears under **Unknown source**. Next, highlight the entry for a source that you want to assign to the new entry, and click on **Manage source**. Set the values for this entry, and save the new object. The new entry now appears as a new object in the list of the corresponding source.

## TCP/UDP service objects

Using the **TCP/UDP service objects** button, you define TCP/UDP services that the IPv6 firewall can use in filter rules.

Click on **Add...** to create a new service.

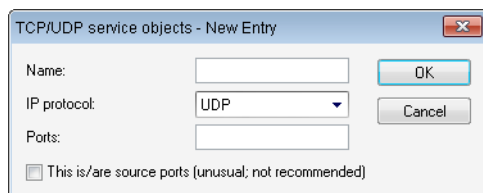

You can set the following properties for the rule:

### Name

Specifies the name of the object.

### IP protocol

Specifies the protocol of the service

### Ports

Specifies the ports for the service. Separate multiple ports with a comma.

! Lists with the official protocol and port numbers are available in the Internet at [www.iana.org](http://www.iana.org).

### This is/are source ports

Determines whether the specified ports are source ports.

 In certain scenarios, it may be useful to specify a source port. This is unusual. Selecting "No" is recommended.

## ICMP service objects

Using the **ICMP service objects** button, you define ICMP services that the IPv6 firewall can use in filter rules.

 Lists with the official ICMP types and port codes are available in the Internet under [www.iana.org](http://www.iana.org).

Click on **Add...** to create a new service.

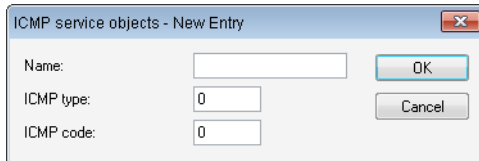

You can set the following properties for the rule:

### Name

Specifies the name of the object.

### ICMP type

Specifies the type of the ICMP service.

### ICMP code

Specifies the code of the ICMP service.

## IP protocol objects

Using the **IP protocol objects** button, you define IP protocol objects that the IPv6 firewall can use in filter rules.

 Lists with the official protocol and port numbers are available in the Internet at [www.iana.org](http://www.iana.org).

Click on **Add...** to create a new object.

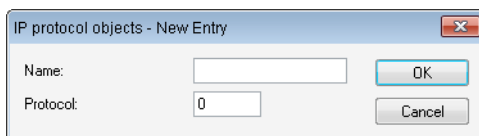

You can set the following properties for the rule:

### Name

Specifies the name of the object.

### Protocol

Defines the protocol number.

## Station list

Using the **Station list** button, you can collect stations into groups. Stations must previously be defined using **Station objects**.



Click on **Add...** to create a new list.

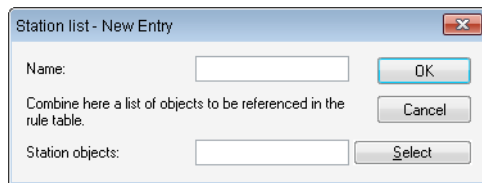

You can set the following properties for a list:

### Name

Determines the name of the list.

### Station objects

Determines the objects that you want to combine in this list. Using **Select** you can choose one or more objects from a list.

If you make a new entry here, it initially appears under **Unknown source**. Next, highlight the entry for a source that you want to assign to the new entry, and click on **Manage source**. Set the values for this entry, and save the new object. The new entry now appears as a new object in the list of the corresponding source.

## Station objects

Using the **Station objects** button, you define stations that the IPv6 firewall can use in filter rules.

Click on **Add...** to create a new object.

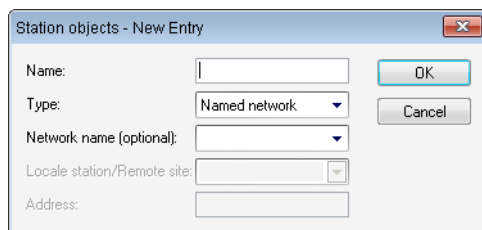

You can set the following properties for the object:

### Name

Specifies the name of the object.

### Type

Determines the station type.

### Network name

Here you enter the name of the network if you selected the appropriate option in the **Type** field.

 Entering the network name is optional.

### Local station/Remote site

Here you enter the name of the remote site if you selected the appropriate option in the **Type** field.

### Address

Here you enter the address of the remote site if you selected the appropriate option in the **Type** field.

## 9.10 Tutorials

### 9.10.1 Setting up IPv6 Internet access

You can set up access to an IPv6 network if

- You have an IPv6-capable device,
- You use a tunneling technology and
- Your provider supports a native IPv6 network or you have access to a so-called tunnel broker who can mediate your IPv6 packets.

#### IPv6 access using the Setup Wizard in LANconfig

The Setup Wizard assists you with the configuration of IPv6 access with your equipment.

The Wizard presents following options:

- *Set up IPv6 access for a new, unconfigured device.*
- *Set up IPv6 access in addition to a functioning IPv4 access for an existing device.*

#### Setup Wizard – setting up IPv6 in a new device

If you have connected up a new device but not have yet configured it, you have the option of using a Setup Wizard to set up IPv4 and IPv6 connections.

To save your entries and proceed to the next screen, click **Next**.

1. Then start the Setup Wizard in LANconfig. Highlight the device to be configured. The Setup Wizard is started either by right-clicking and using the context menu, or with the Magic Wand icon in the toolbar

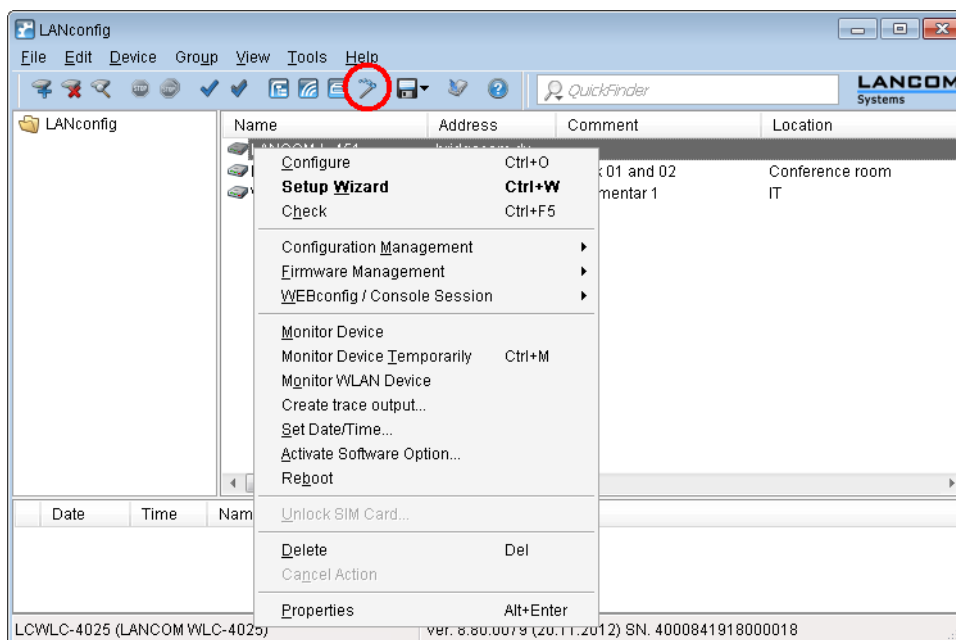

2. In the Setup Wizard, select the option **Set up Internet access**.

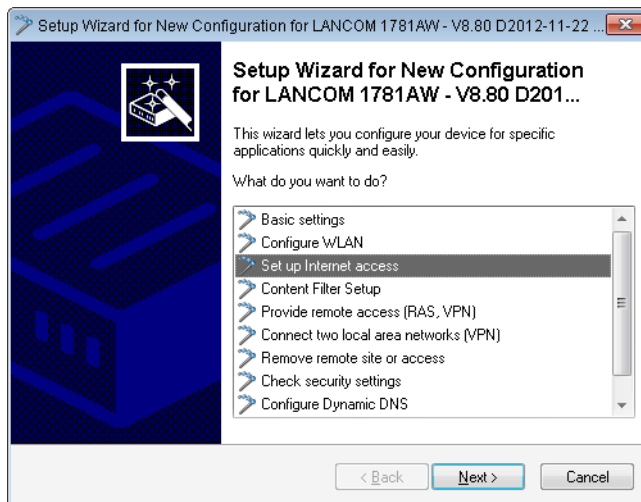

3. You can choose from the following options:

- Set up a dual-stack connection. This is IPv4-and IPv6-capable and currently the recommended option for a new device.
- Set up an IPv4-only connection.
- Set up an IPv6-only connection.

In the following we take you through the setup of a dual-stack connection. Activate the appropriate selection.

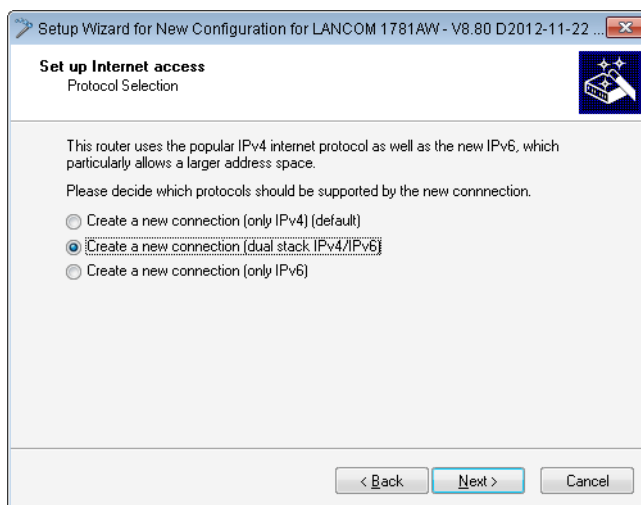

4. Set the interface to be used for the connection.

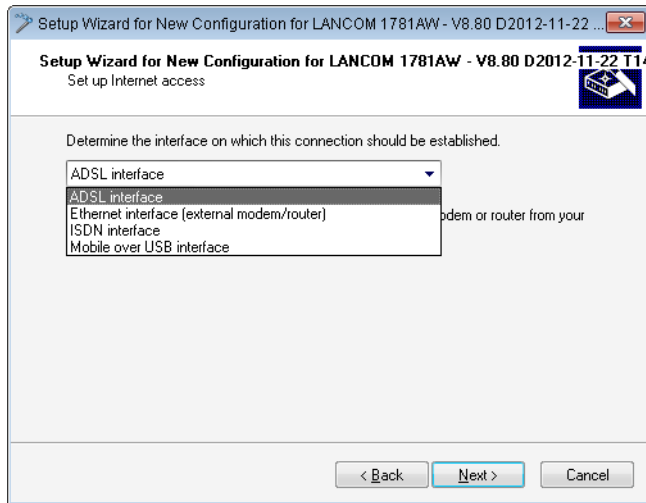

You can select from the following entries:

- ADSL interface
- Ethernet interface (external modem/router)
- ISDN interface
- Mobile over USB interface

5. Select your country from the list.

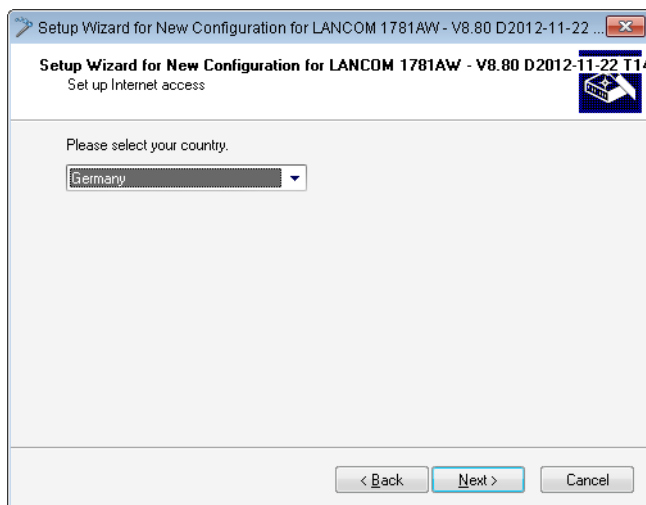

6. Select your Internet provider.

You can select from the following entries:

- A selection of the major Internet providers
- Alternative Internet providers over T-DSL
- Internet access via PPP over ATM (PPPoA)
- Internet access via PPP over Ethernet (PPPoE, PPPoEoA)
- Internet access via plain IP (IPoA)
- Internet access over Plain Ethernet (IPoE, IPoEoA)

7. Enter a name for this connection.

If you access the Internet with an alternative connection, e. g. over a PPPoE connection, you should additionally enter the appropriate ATM parameters.

8. Enter the login details given to you by your provider for setting up your Internet access.

! Depending on the provider, the type and number of fields may vary.

- Specify how you want the device to behave in case of disconnection. You can also specify if and when the device is to carry out a forced re-connection.

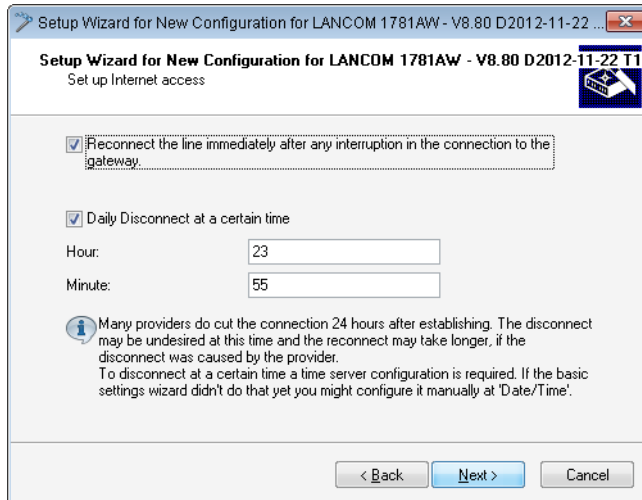

- Define the type of backup connection to be used in case of connection failure.

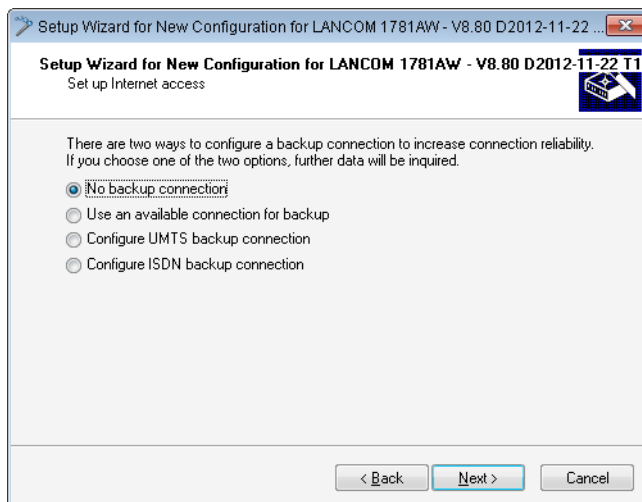

You can select from the following options:

- No backup connection: Skips the configuration of a backup.
- Use the connection already configured in case of backup: In the following dialog, select an already configured connection from a list.
- Setup a backup connection over UMTS: In the next dialog, set up a new UMTS connection. You will need the access data for your UMTS provider.
- Setup a backup connection over ISDN: In the next dialog, set up a new ISDN connection. You will need the access data for your ISDN provider.

11. If your device does not yet have an IP address, enter a new IP address and corresponding netmask.

Setup Wizard for New Configuration for LANCOM 1781AW - V8.80 D2012-11-22 ...

**Setup Wizard for New Configuration for LANCOM 1781AW - V8.80 D2012-11-22 T14**  
Set up Internet access

You have not yet assigned an IP address to your device.  
Please enter an available IP address from your local network, along with the corresponding netmask.

IP address:

Netmask:

< Back   Next >   Cancel

12. Select the type of IPv6 Internet access.

Setup Wizard for New Configuration for LANCOM 1781AW - V8.80 D2012-11-22 ...

**Set up Internet access**  
IPv6 Tunnel Selection

You can use your internet connection with the new internet protocol IPv6 (bigger address space) besides IPv4.

Please select the IPv6 internet access mode:

Additional native IPv6 - direct connection without tunnel

6to4 tunnel - Endpoint is detected automatically (no more settings needed).

6in4 tunnel - Endpoint is supplied by tunnel broker, e.g.

6rd tunnel - Endpoint is supplied by provider.

Please mind that native IPv6 has to be supported by provider.  
A 6to4 tunnel is possible without provider support.

< Back   Next >   Cancel

You can select from the following options:

- **Additional native IPv6:** Configure a direct connection without a tunnel.
- **6to4 tunnel:** Start the wizard to configure a 6to4 tunnel.
- **6in4 tunnel:** Use the input mask to set the parameters for the 6in4 tunnel.
- **6rd tunnel:** Use the input mask to set the parameters for the 6rd tunnel.

Select the option for setting up a native IPv6 Internet connection.

13. Accept the default setting of **Automatically take IPv6 parameters from router advertisements.**

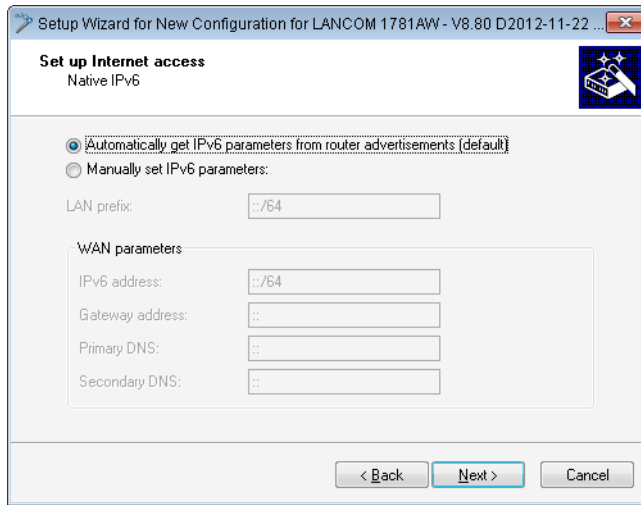

14. You have completed the setup of the native IPv6 Internet access. Click on **Finish** when you are done and the wizard will save your entries to the device.

**Setup Wizard – Setting up IPv6 on an existing device**

If you have a device configured for IPv4 and you wish to set up an additional IPv6 connection, you have the option of setting up the IPv6 connections with the Setup Wizard.

To save your entries and proceed to the next screen, click **Next**.

1. Then start the Setup Wizard in LANconfig. Highlight the device to be configured. The Setup Wizard is started either by right-clicking and using the context menu, or with the Magic Wand icon in the toolbar

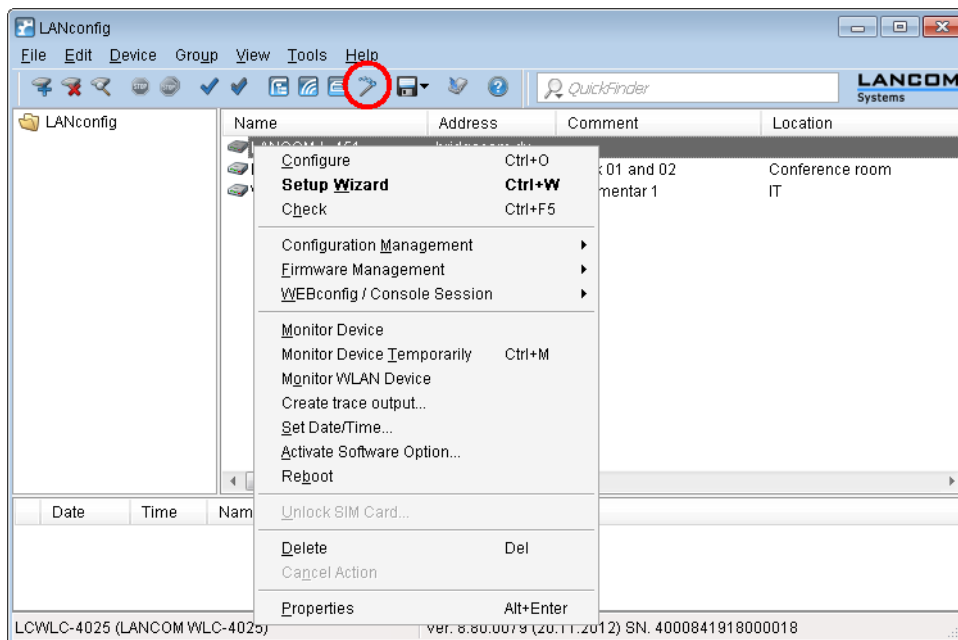



- In the Setup Wizard, select the option **Set up Internet access**. To continue, click on **Next**.

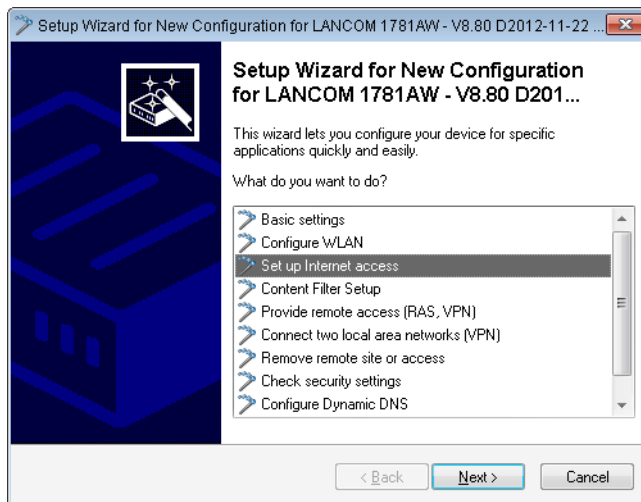

- Because your device is already IPv4-capable, the Setup Wizard gives you the opportunity to extend your existing settings with IPv6. Select this option and click on **Next**.

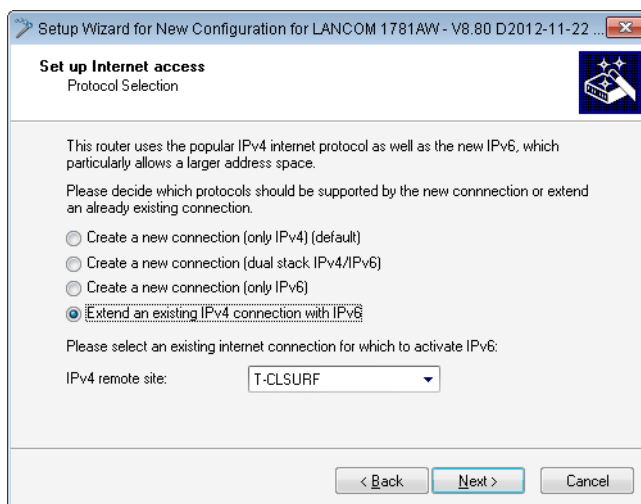

- Select the type of IPv6 Internet access.

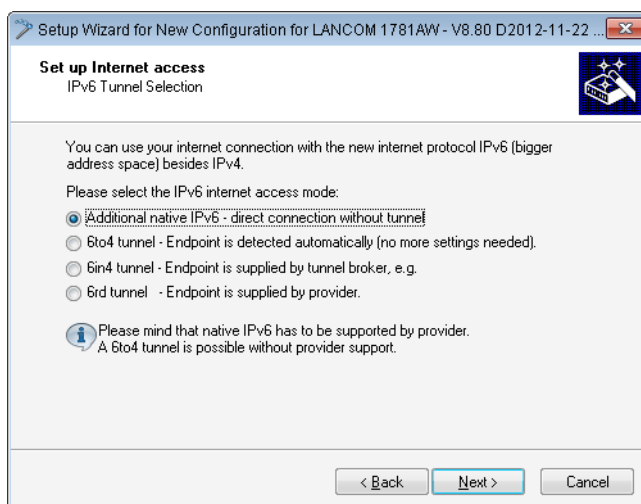

You can select from the following options:

- **Additional native IPv6:** Configure a direct connection without a tunnel.
- **6to4 tunnel:** Start the wizard to configure a 6to4 tunnel.
- **6in4 tunnel:** Use the input mask to set the parameters for the 6in4 tunnel.
- **6rd tunnel:** Use the input mask to set the parameters for the 6rd tunnel.

Select the option for setting up a native IPv6 Internet connection.

5. Accept the default setting of **Automatically take IPv6 parameters from router advertisements.**

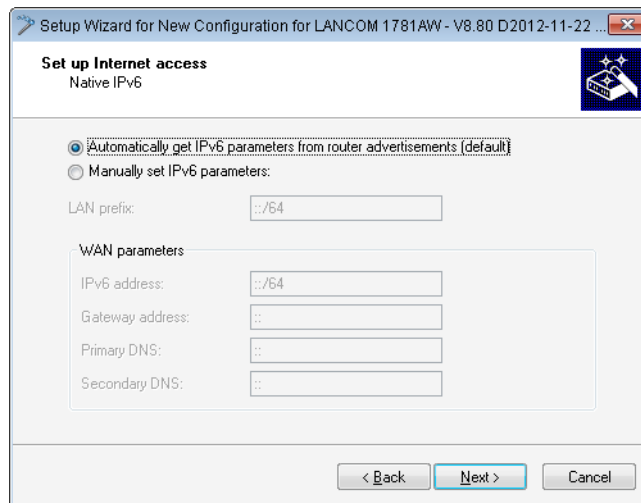

6. You have completed the setup of the native IPv6 Internet access. Click on **Finish** when you are done and the wizard will save your entries to the device.

## 9.10.2 Setting up a 6to4 tunnel

The use of a 6to4 tunnel is feasible when

- Your device is IPv6 capable and you want to access IPv6 services,
- Your provider does not support a native IPv6 network and
- You do not have access to a so-called tunnel broker who can mediate your IPv6 packets.

When using a 6to4 tunnel, the lack of support of IPv6 by the provider means the device does not receive an IPv6 address or an IPv6 prefix.

The device calculates its own unique prefix from "2002::/16" and the hexadecimal representation of its own public IPv4 address from the provider. This application only works if the device has a public IPv4 address. The device does not receive a public IPv4 address but an IPv4 address from a private address range only, for example when it accesses the Internet via UMTS and the provider supplies an IP address from its private address range, or if the device does not access the Internet directly, but is "behind" another router.

 Connections through a 6to4 tunnel work with relays that are selected by the IPv4 Internet provider's backbone. The device administrator has no influence on relay selection. Furthermore, the relay used can change without the administrator knowing about it. For this reason, connections via a 6to4 tunnels are suitable **for test purposes only**. In particular, avoid using 6to4-tunnel data connections for productive systems or for the transmission of confidential data.

### Working with LANconfig

To set up a 6to4 tunnel with LANconfig, proceed as follows:

1. LANconfig can be started from the Windows Start bar: Click on **Start > Programs > LANCOM > LANconfig**. LANconfig now automatically searches the local network for devices.

2. Select the device on which you want to set up a 6to4 tunnel. Select it with a left-click and start the configuration from the menu bar with **Device > Configure**.
3. Navigate to **IPv6 > Tunnel** and click on **6to4 tunnel**.

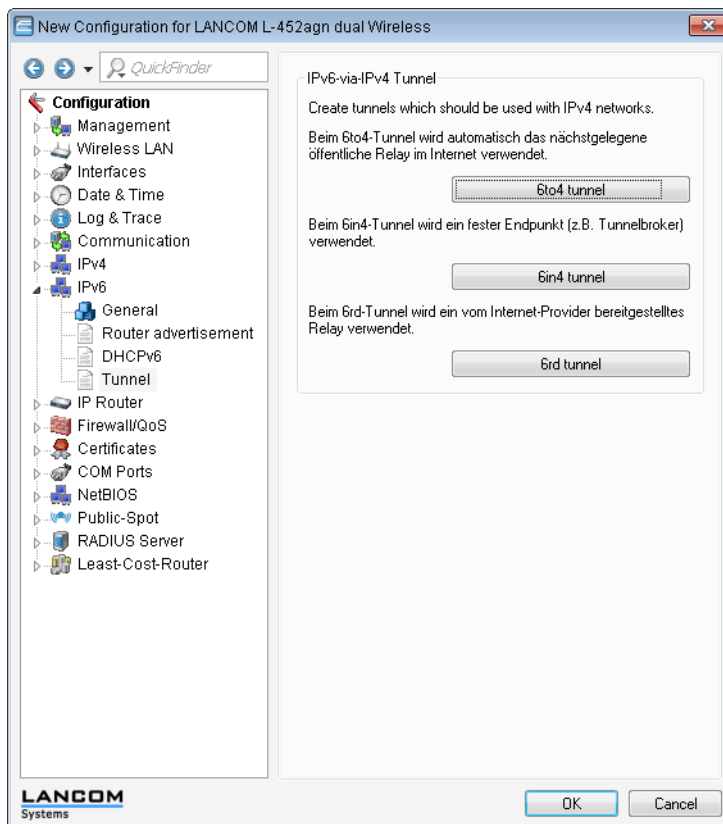

4. Click on **Add** to create a new 6to4 tunnel.

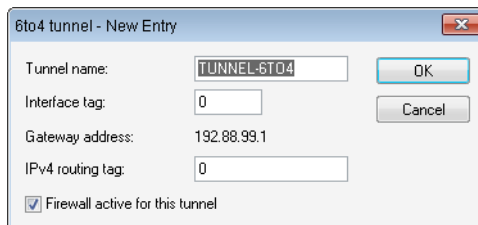

5. Set the name of the 6to4 tunnel.
6. Set the **Interface tag** to a value that uniquely identifies the network. All packets received by this device on this network will be internally marked with this tag. The interface tag enables the routes which are valid for this network to be separated even without explicit firewall rules.
7. The **Gateway address** is set by default to the anycast address "192.88.99.1". This address can only be changed with WEBconfig or Telnet.
8. Here you define the routing tag that the device uses to determine the route to the associated remote gateway. The **IPv4 routing tag** specifies which tagged IPv4 route is to be used for the data packets to reach their destination address.
9. The default value is this tunnel's firewall.  
If you disable the global firewall, you should also disable the firewall for the tunnel.
10. Accept your entries with **OK**.

11. Change to the directory **IPv6 > Router advertisements**.

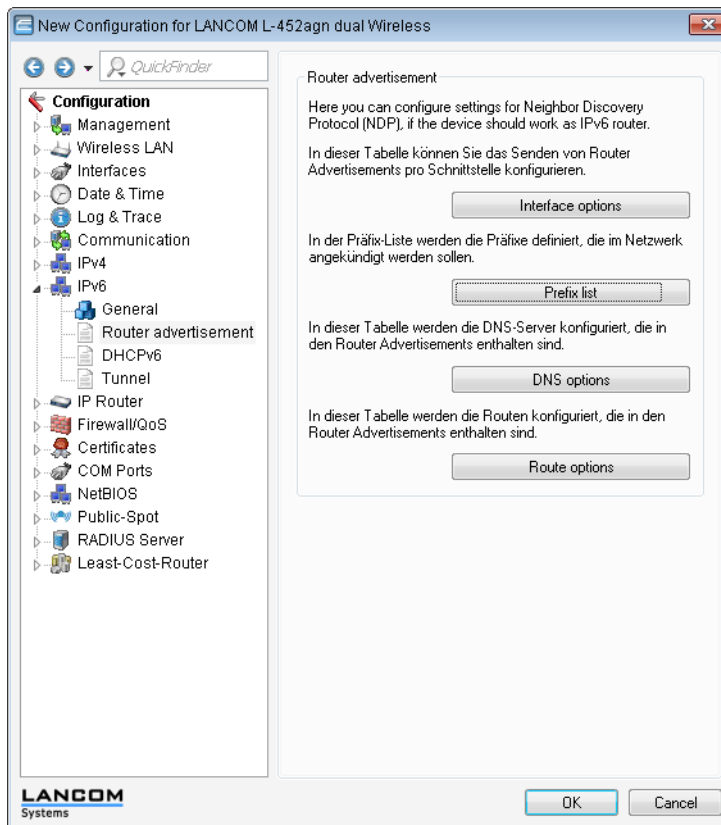

12. Open the **Prefix list** and click on **Add**.

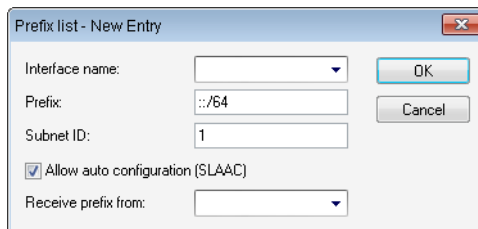

13. Enter a name for the interface that is used by the 6to4 tunnel, e. g. "INTRANET".
14. Set the value for the **Prefix** to "::/64" in order to accept the prefix issued by the provider automatically and in its entirety.
15. Accept the default value of "1" for the **Subnet ID**.
16. Accept the activated option **Stateless address configuration**.
17. In the field **Prefix delegation from**, enter the name of the tunnel that you have defined earlier, e.g. in the example above "TUNNEL-6TO4".
18. Accept your entries with **OK**.
19. In the directory **IPv6 > Router advertisements**, open the **Interface options**, select the entry INTRANET and click on **Edit**.

20. In the drop-down menu **Send router advertisements** select the option 'Yes'.

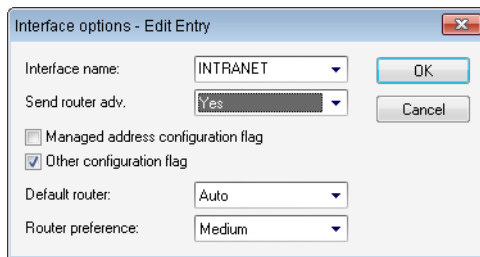

21. Accept all other default values without change.  
 22. Save your entries with **OK**.  
 23. Change to the directory **IP router > Routing**.

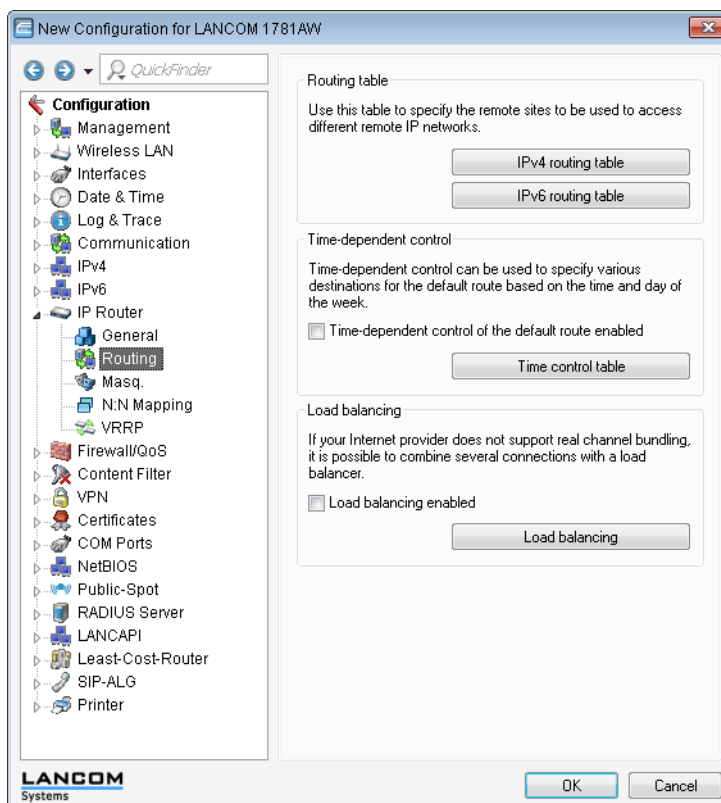

24. Open the **IPv6 routing table** and click on **Add**.

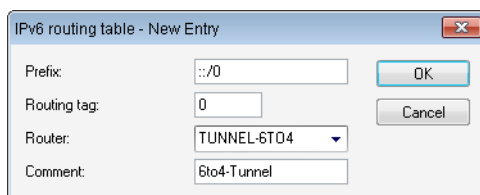

25. Set the **Prefix** to the value ":::0".  
 26. In the field **Routing tag** accept the default value "0".  
 27. In the field **Router**, select from the list the name of the tunnel that you defined earlier, e.g. in the example above "TUNNEL-6TO4".  
 28. Enter a descriptive **Comment** for this entry.  
 29. Save your entries with **OK**.

30. Change to the directory **IPv6 > General** and enable the IPv6 stack.

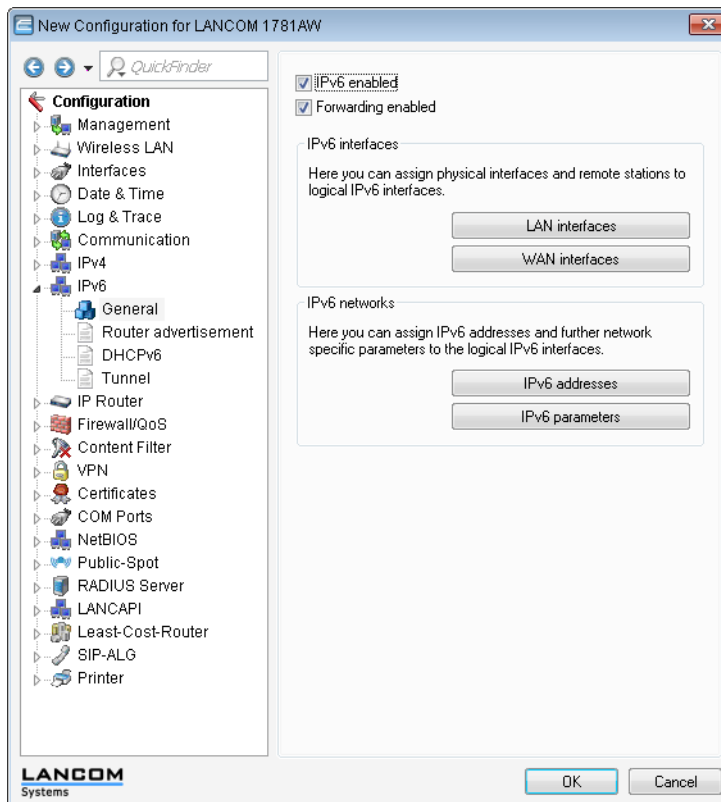

## Working with WEBconfig

To set up a 6to4 tunnel with WEBconfig, proceed as follows:

1. Type into your browser's address bar the address of the device to be set up with a 6to4 tunnel.
2. Change to the directory **LCOS Menu Tree > Setup > IPv6 > Tunnel > 6to4** and click on **Add**.

3. Enter a name for the remote peer, e. g. "TUNNEL-6TO4".
4. Leave the **Routing tag** unchanged as the default value "0".
5. As the **Gateway address** you can accept the default value "192.88.99.1". This is the default anycast address for 6to4 relays that your device connects to.

This address is the reason why 6to4 tunnels are unstable and insecure. There is no assurance that a 6to4 relay will be available, and publicly available 6to4 relays may not be trustworthy. There is no guarantee that the relay does not record your traffic.

6. In the field **IPv4-Rtg-tag** accept the default value "0"

7. Enable the **firewall** for this tunnel.  
If you disable the global firewall, you should also disable the firewall for the tunnel.
8. Save your entries with **Send**.
9. Change to the directory **LCOS Menu Tree > Setup > IPv6 > Router-Advertisement**, open the **Prefix options** table and click on **Add**.

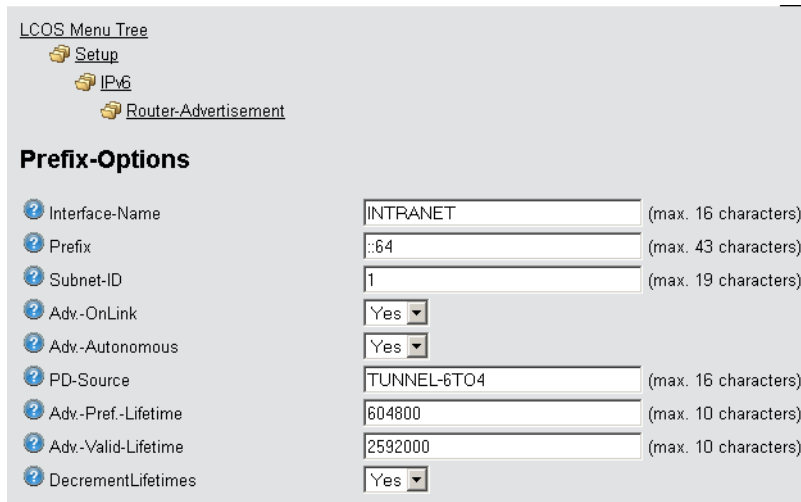

LCOS Menu Tree

- Setup
- IPv6
- Router-Advertisement

### Prefix-Options

Interface-Name	INTRANET	(max. 16 characters)
Prefix	:::64	(max. 43 characters)
Subnet-ID	1	(max. 19 characters)
Adv.-OnLink	Yes	
Adv.-Autonomous	Yes	
PD-Source	TUNNEL-6TO4	(max. 16 characters)
Adv.-Pref.-Lifetime	604800	(max. 10 characters)
Adv.-Valid-Lifetime	2592000	(max. 10 characters)
DecrementLifetimes	Yes	

10. Enter a name for the interface that uses the 6to4 tunnel, e. g. "INTRANET".
11. Set the value for the **Prefix** to ":::64" in order to accept the prefix issued by the provider automatically and in its entirety.
12. Accept the default value of "1" for the **Subnet ID**.
13. Set **PD source** to the name of the remote peer that you previously defined in the example above, e.g. "TUNNEL-6TO4".
14. Save your entries with **Send**.
15. Change to the directory **LCOS Menu Tree > Setup > IPv6 > Router-Advertisement**, open the **Interface options** table and click on **Add**.

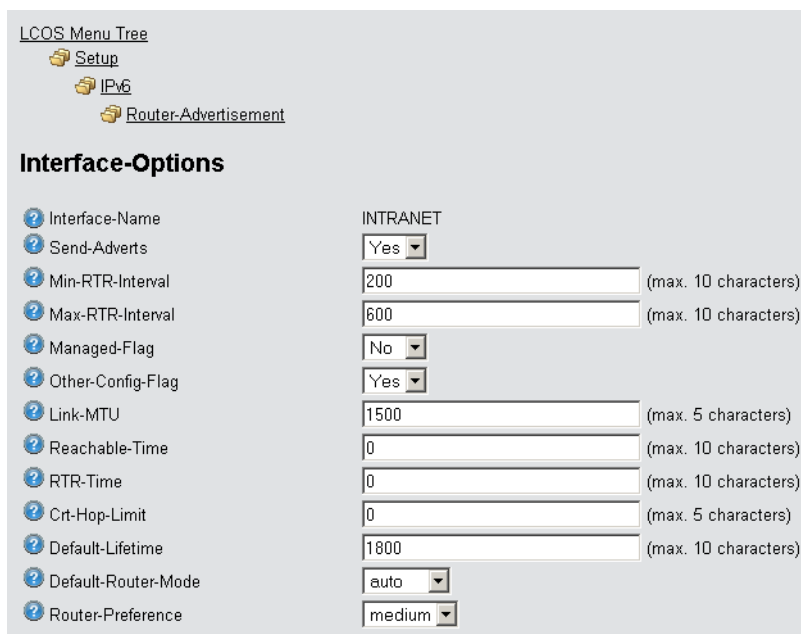

LCOS Menu Tree

- Setup
- IPv6
- Router-Advertisement

### Interface-Options

Interface-Name	INTRANET	
Send-Adverts	Yes	
Min-RTR-Interval	200	(max. 10 characters)
Max-RTR-Interval	600	(max. 10 characters)
Managed-Flag	No	
Other-Config-Flag	Yes	
Link-MTU	1500	(max. 5 characters)
Reachable-Time	0	(max. 10 characters)
RTR-Time	0	(max. 10 characters)
Crt-Hop-Limit	0	(max. 5 characters)
Default-Lifetime	1800	(max. 10 characters)
Default-Router-Mode	auto	
Router-Preference	medium	

16. Accept all other default values without change.
17. Save your entries with **Send**.

18. Change to the directory **LCOS Menu Tree > Setup > IPv6**, open the **Routing table** and click on **Add**.

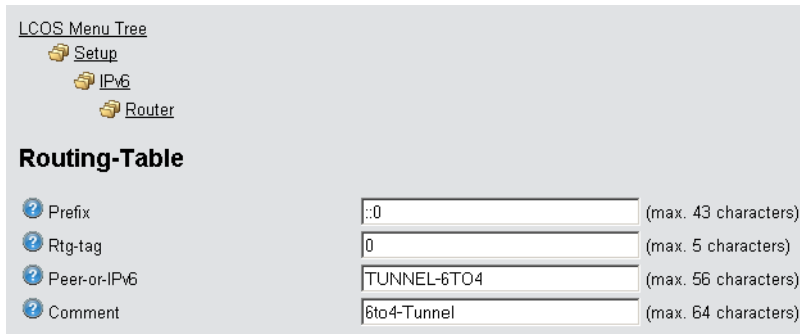

LCOS Menu Tree

- Setup
  - IPv6
    - Router

**Routing-Table**

Prefix	<input type="text" value="::0"/>	(max. 43 characters)
Rtg-tag	<input type="text" value="0"/>	(max. 5 characters)
Peer-or-IPv6	<input type="text" value="TUNNEL-6TO4"/>	(max. 56 characters)
Comment	<input type="text" value="6to4-Tunnel"/>	(max. 64 characters)

19. Set the **Prefix** to the value "::/0".
20. In the field **Rtg-tag** accept the default value "0".
21. In the field **Peer or IPv6**, enter the name of the interface that will use the 6to4 tunnel, e.g. "TUNNEL-6TO4" in the example above.
22. Enter a descriptive **Comment** for this entry.
23. Save your entries with **Send**.
24. Enable the IPv6 stack under **LCOS Menu Tree > Setup > IPv6** by setting the option **Operating** to "yes" and save with **Send**.

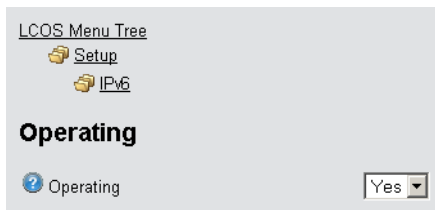

LCOS Menu Tree

- Setup
  - IPv6

**Operating**

Operating

## 9.11 Addition(s) to LCOS 8.82

### 9.11.1 Reconfigure function of the DHCPv6 server

Each IPv6 address or IPv6 prefix has a default life time assigned by the server. At certain intervals, a client asks the server to renew its address (called renew/rebind times).

However, if the WAN prefix changes, for example, due to disconnection and reconnection of an Internet connection or a request for a new prefix (Deutsche Telekom Privacy feature), the server has no way to inform the network devices that the prefix or address has changed. This means that a client is still using an old address or an old prefix, and can no longer communicate with the Internet.

As of the LCOS 8.82 version, the DHCPv6 server on IPv6-capable LANCOM devices can require clients in the network to renew their leases/bindings.



## Enhancements to LANconfig

### IPv6 configuration menu

Where previous versions provided configuration menus for TCP/IP for IPv4, you now find the options **IPv4** and **IPv6**.

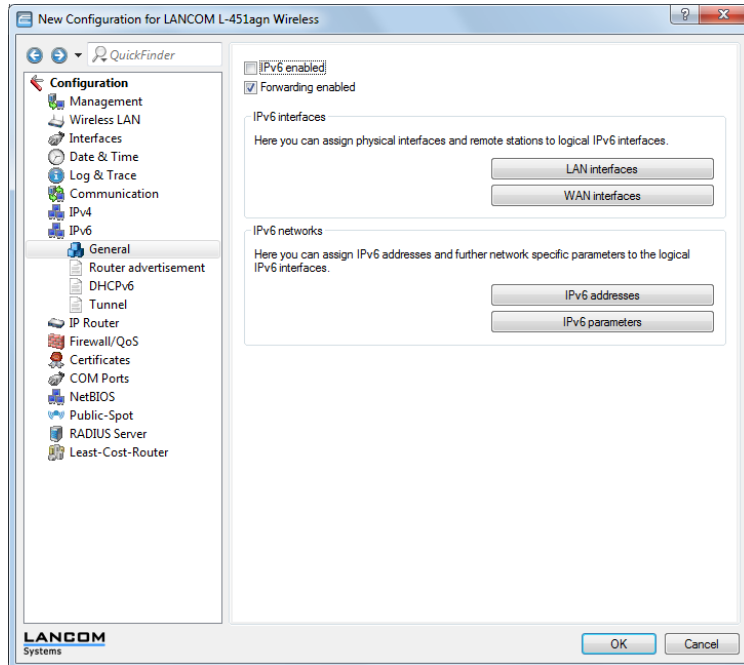

Click on **IPv6** to adjust the settings for this protocol. The **IPv6** configuration is divided into the options

- **General,**
- **Router advertisement,**
- **DHCPv6 and**
- **Tunnel.**

By default a click on **IPv6** takes you straight to the **General** options.

## DHCPv6

This is where you configure the DHCPv6 server, the DHCPv6 client and the DHCPv6 relay agent.

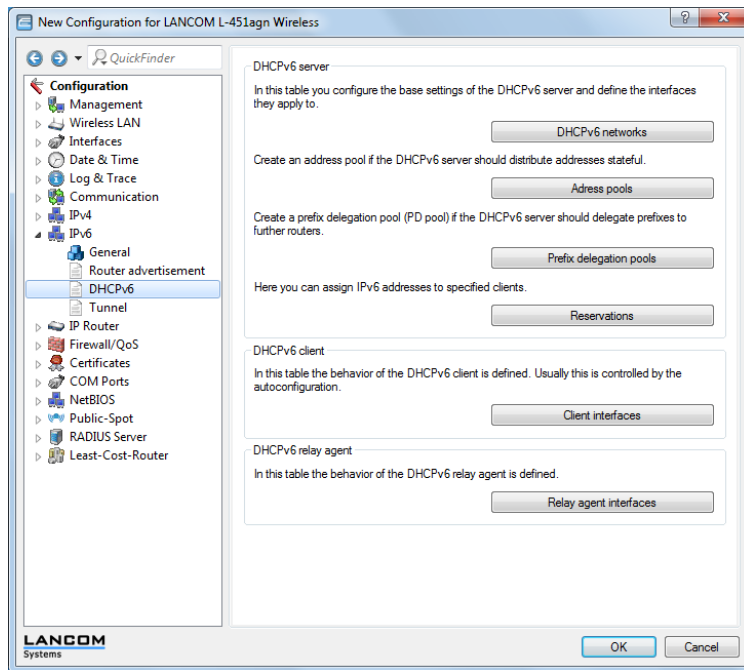

## DHCPv6 server

Use the following buttons to access the tables and adjust the respective functions:

### DHCPv6 networks

This table is used to configure the basic settings of the DHCPv6 server, and to specify which interfaces they apply to.

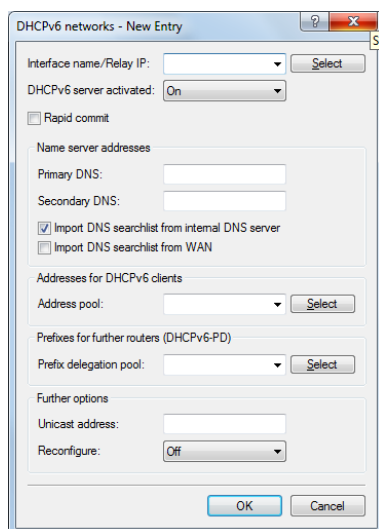

### Interface name/Relay IP

Name of the interface on which the DHCPv6 server is working, for example "INTRANET". Alternatively, you can also enter the IPv6 address of the remote DHCPv6 relay agent.

### DHCP server activated

Activates or deactivates the entry.

**Rapid commit**

With rapid commit activated, the DHCPv6 server responds directly to a solicit message with a reply message.

 The client must explicitly include the rapid commit option in its solicit message.

**DNS default**

IPv6 address of the primary DNS server.

**DNS backup**

IPv6 address of the secondary DNS server.

**Import DNS search list from internal DNS server**

Indicates whether the DNS search list or the own domain for this logical network should be inserted from the internal DNS server, e.g., "internal". The own domain can be configured under **IPv4 > DNS > General settings**. The default setting is "enabled".

**Import DNS search list from WAN**

Specifies whether the DNS search list sent by the provider (e.g., provider-xy.de) is announced in this logical network. The default setting is "disabled".

**Address pool**

Name of the address pool used for this interface.

 If the DHCPv6 server operates 'stateful' addresses distribution, you must enter the corresponding addresses into the **Address pools** table.

**Prefix delegation pool**

Name of prefix pools to be used by the DHCPv6 server.

 If the DHCPv6 server is to delegate prefixes to other routers, you must enter the corresponding prefixes in the table **Prefix delegation pools**.

**Unicast address**

By default the DHCPv6 server exclusively responds to multicast requests. If the DHCPv6 server should respond to a unicast request, this IPv6 address can be configured here. Generally speaking, multicast is sufficient for communication.

**Reconfigure**

Each IPv6 address or IPv6 prefix has a default life time assigned by the server. At certain intervals, a client asks the server to renew its address (called renew/rebind times).

However, if the WAN prefix changes, for example, due to disconnection and reconnection of an Internet connection or a request for a new prefix (Deutsche Telekom Privacy feature), the server has no way to inform the network devices that the prefix or address has changed. This means that a client is still using an old address or an old prefix, and can no longer communicate with the Internet.

The reconfigure feature allows the DHCPv6 server to require the clients in the network to request a renewal of leases / bindings. If the client successfully negotiates a re-configuration (reconfigure) with the server during first contact, the server can request the client to update its address or other information at any time. The mechanism is protected by the so-called *Reconfigure Key*, so that only the original server with the correct key can make requests to the client. If the client receives a reconfigure message without a valid reconfigure key, the client rejects this invocation.

The *Reconfigure Key Authentication Protocol* according to RFC 3315 is supported for *Renew* and *Information-Request*, as well as *Rebind* according to RFC 6644. Reconfiguration is started on the console of the device using a "do" command in the status tree (see the description of the status tree).

 You can find more about the status of a client regarding the Reconfigure function under **Status > IPv6 > DHCPv6 > Server > Clients**.

The following settings are available:

- **Off:** Disables the reconfigure function
- **Reject:** Clients that have used the Reconfigure Option in queries are rejected by the server and are not assigned an address, prefix or other options.
- **Allow:** If the client sets the Reconfigure Option in queries, the server negotiates the necessary parameters with the client in order to start a reconfiguration at a later time.
- **Require:** Clients have to set the Reconfigure Option in queries, otherwise the client rejects these clients. This mode is makes sense when you want to ensure that the server only serves clients which support Reconfigure. This ensure that all clients can use Reconfigure to update their addresses, prefixes, or other information at a later point in time.

## Address pools

If distribution of the DHCPv6 server is to be stateful, this table defines an address pool:

### Address pool name

Name of the address pool

### Start address

First address in the pool, e.g. "2001:db8::1"

### End address

Last address in the pool, e.g. "2001:db8::9"

### Preferred lifetime:

Here you specify the time in seconds that the client should treat this address as 'preferred'. After this time elapses, a client classifies this address as "deprecated".

### Validity period

Here you specify the time in seconds that the client should treat this address as 'valid'.



If you use a prefix from a WAN interface for dynamic address formation, you cannot configure values for `preferred lifetime` and `valid lifetime`. In this case, the device automatically determines the values that apply to the prefix delegated by the provider.

### Receive prefix from

With this parameter you can assign addresses to the network clients from the prefix that the router retrieved from the WAN interface via DHCPv6 prefix delegation. Select the desired WAN interface here. For example, if the provider assigned the prefix "2001:db8::/64", you can then enter the value "::1" in the parameter **First address** and "::9" in **Last address**. In combination with the prefix "2001:db8::/64" as delegated by the provider, the clients receive addresses from the pool "2001:db8::1" to "2001:db8::9". If the provider prefix is greater than "/64", e.g., "/48" or "56", you must take subnetting for the logical network in to account in the address. **Example:**

- Assigned provider prefix: "2001:db8:abcd:aa::/56"
- "/64" as the prefix of the logical network (subnet ID 1): "2001:db8:abcd:aa01::/64"
- First address: "0:0:0:0001::1"
- Last address: "0:0:0:0001::9"

**!** You should only use this mechanism if the provider assigns a fixed prefix. Otherwise, it is possible that the provider delegates a new prefix to the router, but the client still has an address from the pool with the old prefix. In this case, the client must update its address at the server.

### Prefix delegation pool

In this table, you specify the prefixes that the DHCPv6 server delegates to other routers:

#### PD pool name

Name of the PD pool

#### First prefix

First prefix for delegation in the PD pool, e.g. "2001:db8:1100::"

#### Last prefix

Last prefix for delegation in the PD pool, e.g. "2001:db8:FF00::"

#### Prefix length

Length of the prefixes in the PD pool, e.g. "56" or "60"

#### Preferred lifetime:

Here you specify the time in seconds that the client should treat this prefix as 'preferred'. After this time elapses, a client classifies this address as "deprecated".

#### Validity period

Here you specify the time in seconds that the client should treat this prefix as 'valid'.

**!** If you use a prefix from a WAN interface for dynamic address formation, you cannot configure values for `preferred lifetime` and `valid lifetime`. In this case, the device automatically determines the values that apply to the prefix delegated by the provider.

#### Receive prefix from

Name of the WAN interface from which the client should use the prefix to form the address or prefix.

### Reservations

If you want to assign fixed IPv6 addresses to clients or fixed prefixes to routers, you can use this table to make a reservation for each client.

**Interface name or relay**

Name of the interface on which the DHCPv6 server is working, for example "INTRANET". Alternatively, you can also enter the IPv6 address of the remote relay agent.

**Address/PD prefix**

IPv6 address or PD prefix that you want to assign statically.

**Client ID**

DHCPv6 unique identifier (DUID) of the client.

DHCPv6 clients are no longer identified with their MAC addresses like DHCPv4 clients, they are identified with their DUID instead. The DUID can be read from the respective client, for example, on Windows with the shell command `ipconfig /all` or in WEBconfig under **Status > IPv6 > DHCPv6 > Client > Client ID**.

For devices working as a DHCPv6 server, the client IDs for clients that are currently using retrieved IPv6 addresses are to be found under **Status > IPv6 > DHCPv6 > Server > Address bindings**, and retrieved IPv6 prefixes are under **Status > IPv6 > DHCPv6 > Server > PD bindings**.

LANmonitor displays that client IDs under **DHCPv6 server**.

**Preferred lifetime:**

Here you specify the time in seconds that the client should treat this address as 'preferred'. After this time elapses, a client classifies this address as "deprecated".

**Validity period**

Here you specify the time in seconds that the client should treat this address as 'valid'.



If you use a prefix from a WAN interface for dynamic address formation, you cannot configure values for `preferred lifetime` and `valid lifetime`. In this case, the device automatically determines the values that apply to the prefix delegated by the provider.

**Receive prefix from**

Name of the WAN interface from which the client should use the prefix to form the address or prefix.

**Additions to the Setup menu****Reconfigure**

Each IPv6 address or IPv6 prefix has a default life time assigned by the server. At certain intervals, a client asks the server to renew its address (called renew/rebind times).

However, if the WAN prefix changes, for example, due to disconnection and reconnection of an Internet connection or a request for a new prefix (Deutsche Telekom Privacy feature), the server has no way to inform the network devices that the prefix or address has changed. This means that a client is still using an old address or an old prefix, and can no longer communicate with the Internet.

The reconfigure feature allows the DHCPv6 server to require the clients in the network to request a renewal of leases / bindings.

**SNMP ID:**

2.70.3.1.4.13

**Telnet path:**

**Setup > IPv6 > DHCPv6 > Server > Interface-List**

**Possible values:**

**Off:** Disables the reconfigure function

**Prohibit:** Clients that have used the Reconfigure Option in queries are rejected by the server and are not assigned an address, prefix or other options.

**Allow:** If the client sets the Reconfigure Option in queries, the server negotiates the necessary parameters with the client in order to start a reconfiguration at a later time.

**Force:** Clients have to set the Reconfigure Option in queries, otherwise the client rejects these clients. This mode is makes sense when you want to ensure that the server only serves clients which support Reconfigure. This ensure that all clients can use Reconfigure to update their addresses, prefixes, or other information at a later point in time.

**Default:**

Off

## Additions to the Status menu

### Reconfigure

This action causes the clients in the network to renew their leases/bindings. It can be triggered by a Reconfigure for Renew, Rebind, or Information Request.

The reconfigure function will then expect the following parameters:

- **renew:** (optional, default) Asks the client to perform a renewal for his address and/or prefix.
- **rebind:** (optional) Asks the client to perform a rebind for his address and/or prefix.
- **info:** (optional) Asks the client to send an Information-Request, in order to, for example, update its DNS server.
- **-c <Client-ID>:** The reconfigure function applies to the client with the specified client ID.
- **-b <Address/Prefix>:** The reconfigure function applies to the client with the specified address and the specified prefix.
- **-i <Interface/Relay>:** The reconfigure function applies to all clients that are connected to the specified interface or relay.
- **-a:** The reconfigure function applies to all clients.

**SNMP ID:**

1.77.3.1.7

**Telnet path:**

**Status > IPv6 > DHCPv6 > Server**

## 10 Quality of Service

This chapter dedicates itself to quality: Under the generic term Quality of Service (short: QoS) those LCOS functions are summarized, which are concerned with the guarantee of certain service availabilities.

### 10.1 Why QoS?

The main objective of Quality of Service is to transfer certain data packets either particularly safe or as immediately as possible:

- It may happen during a data transfer that data packets are not delivered to the addressee. But for some applications it is very important that all sent packets really do arrive. An e-mail, for example, divided into several small data packets, can only be assembled together again, when all parts have arrived completely. Whether one or another packet arrives with little time delay does not make any difference. These applications often count on the connection-orientated Transmission Control Protocol (TCP). This protocol ensures that data will be transferred correctly and chronologically via the net. It automatically adjusts the sending rate downwards if the confirmation of sent data packets is outstanding for longer times, and also takes care of repeated transmission in case of packet losses.
- In other applications, e.g. telephony via the Internet (Voice-over-IP, VoIP), it is - differently to the case above - very important that the data packets arrive at the addressee with only little time delay. But it really doesn't matter if once a data packet gets lost in this case. The participant at the other end of the connection will understand the caller, even if small parts of the speech got lost. This application aims at the fastest sending of data packets as possible. The connectionless User Datagram Protocol (UDP) is often used for this kind of application. Also this protocol has very little administrative overhead. But chronological delivery of packets is not guaranteed, data packets are simply sent out. Because no confirmation receipt exists, lost packets never get delivered again.

### 10.2 Which data packets to prefer?

The necessity of a QoS concept results only from the fact that the available bandwidth is not always sufficient for transferring all pending data packets reliably and on time. Load peaks result easily from running simultaneously large FTP downloads, while exchanging e-mails and using IP telephones over the data line. In order to meet also in these situations the demands of the desired data transfer, certain data packets must be treated preferentially. It is necessary for this, that at first a LANCOM recognizes which data packets should be preferred at all.

There are two possibilities to signal the need for a preferential treatment of data packets in the LANCOM:

- The application, as e.g. the software of certain IP telephones, is itself able to mark the data packets appropriately. This marking, the "tag", is set within the header of the IP packets. The two different variants of this marking "ToS" and "DiffServ" can simply be described as follows:
  - ToS "Low Delay"
  - ToS "High Reliability"
  - DiffServ "Expedited Forwarding"
  - DiffServ "Assured Forwarding"

! The IP header bits of the ToS resp. DiffServ field are copied in case of a VPN route also into the enclosing IP header of the IPsec VPN packet. Thus QoS is available also for VPN routes over the Internet, as long as your provider treats according packets preferentially also in the WAN.



- When the application itself has no possibility to mark the data packets appropriately, the LANCOM can ensure the correct treatment. For this, it uses the existing functions of the firewall, which can classify e.g. data packets according to subnets or services (applications). Due to these functions it is e. g. possible to treat individually data packets of a FTP connection or those of a certain department (in a separate subnet).

For treatment of data packets classified by the firewall the following two possibilities can be chosen:

- Guaranteed minimum bandwidth
- Limited maximum bandwidth

## 10.2.1 What is DiffServ?

DiffServ stands for "Differentiated Services" and is a quite recent model to signal the priority of data packets. DiffServ is based on the known Type-of-Service (ToS) field and uses the same byte within the IP header.

ToS is using the first three bits to describe the priorities (precedence) 0 to 7, as well as four further bits (the ToS bits) to optimize the data stream (e.g. "Low Delay" and "High Reliability"). This model is rather inflexible, and this is why it has been used quite rarely in the past.

The DiffServ model uses the first 6 bits to make distinctions of different classes. Up to 64 gradings are thus possible (Differentiated Services Code Point, DSCP) which enable a finer prioritisation of the data stream:

- To ensure downward compatibility with ToS implementations, the previous precedence levels can be depicted with the "Class Selectors" (CS0 to CS7). Thereby, the level "CS0" denotes so-called "Best Effort" (BE) and stands for usual transfer of data packets without special treatment.
- The "Assured Forwarding" classes are used for a secured transfer of data packets. The first digit of the AF class describes each the priority of the transfer (1 to 4), the second digit the "drop probability" (1 to 3). Packets with AFxx marking are transferred in a secured way, and thus not dropped.

Finally, the class "Expedited Forwarding" marks those packets, that shall be transferred preferentially, before all other packets.

Code point	DSCP bits	Dec.	Code point	DSCP bits	Dec.	Code point	DSCP bits	Dec.
CS0 (BE)	000000	0	AF11	001010	10	AF33	011110	30
CS1	001000	8	AF12	001100	12	AF41	100010	34
CS2	010000	16	AF13	001110	14	AF42	100100	36
CS3	011000	24	AF21	010010	18	AF43	100110	38
CS4	100000	32	AF22	010100	20	EF	101110	46
CS5	101000	40	AF23	010110	22			
CS6	110000	48	AF31	011010	26			
CS7	111000	56	AF32	011100	28			

## 10.2.2 Guaranteed minimum bandwidths

Hereby you give priority to enterprise-critical applications, e.g. Voice-over-IP (VoIP) PBX systems or certain user groups.

For LANCOM devices with VoIP functions that were already integrated or added in with a software option, the QoS settings for SIP calls are defined automatically.

### Full dynamic bandwidth management for sending

Concerning the sending direction, the bandwidth management takes place dynamically. This means that e.g. a guaranteed minimum bandwidth is only available, as long as the corresponding data transfer really exists.

An example:

For the transmission of VoIP data of an appropriate VoIP gateway, a bandwidth of 256 Kbps is to be guaranteed always. Thereby, each individual VoIP connection consumes 32 Kbps.

As long as nobody telephones, the entire bandwidth is at the disposal to other services. Per adjacent VoIP connection 32 Kbps less is available to other applications, until 8 VoIP connections are active. As soon as a VoIP connection is terminated, the corresponding bandwidth is available again to all other applications.

 For correct functioning of this mechanism, the sum of the configured minimum bandwidth must not exceed the effectively available transmission bandwidth.

### Dynamic bandwidth management also for reception

For receiving bandwidth control, packets can be buffered and only belatedly confirmed. Thus TCP/IP connections regulate themselves automatically on a smaller bandwidth.

Each WAN interface is assigned a maximum reception bandwidth. This bandwidth will be accordingly degraded by every QoS rule that guarantees a minimum bandwidth of reception on this interface.

- If the QoS rule has been defined connection-related, the reserved bandwidth will be unblocked immediately after releasing the connection and the maximum available bandwidth will increase accordingly on the WAN interface.
- If the QoS rule has been defined globally, then the reserved bandwidth will be unblocked only after the ending of the last connection.

## 10.2.3 Limited maximum bandwidths

Hereby you limit e.g. the entire or connection-related maximum bandwidth for server accesses.

An example:

You operate both a Web server and a local network on a shared Internet access.

To prevent that your productive network (LAN) is paralyzed by many Internet accesses to your Web server, all server accesses are limited to half of the available bandwidth. Furthermore, in order to guarantee that your server services are available equally to many users at the same time, a certain maximum bandwidth per each server connection is set.

### Combination possible

Minimum and maximum bandwidths can be used together in combination. Thus the available bandwidth can be distributed accordingly depending on your requirements, e.g. on certain user groups or applications.

## 10.3 The queue concept

### 10.3.1 Queues in transmission direction

Quality of Service requirements are realized in LCOS by using different queues for the data packets. For the transmission side, the following queues are utilized:

#### ■ Urgent queue I

This queue is always processed at first before all others. The following data packets are handled here:

- Packets with ToS "Low Delay"
- Packets with DiffServ "Expedited Forwarding"
- All packets that have been assigned a certain minimum bandwidth, as long as the guaranteed minimum bandwidth is not exceeded.
- TCP control packets can be likewise dispatched by this queue preferentially .

#### ■ Urgent queue II

This is for all packets that have been assigned a guaranteed minimum bandwidth, but whose connection has exceeded this minimum bandwidth.

As long as the interval for the minimum bandwidth is not exceeded (i.e. up to the end of the current second), all packets in this queue are treated without further special priority. All packets of this queue, of the "secured queue" and the "standard queue" share now the existing bandwidth. The packets are taken in order from the queues when sending in exactly the same sequence, in which they have been placed into these queues. If the interval runs off, all blocks, which are at this time still in the "Urgent queue II" up to the exceeding of the in each case assigned minimum bandwidth, are placed again into the "Urgent queue I". The rest remains in the "Urgent queue II".

With this procedure it is guaranteed that prioritized connections do not crush the remaining data traffic.

- Secured queue

This queue does not have a separate priority. However, packets in this queue are never dropped (transmission guaranteed).

- Packets with ToS "High Reliability"
- Packets with DiffServ "Assured Forwarding"

- Standard queue

The standard queue contains all not classified data traffic. Packets in this queue are dropped at first when packets cannot be delivered fast enough.

The queue concept can, however, only work out when a "traffic congestion" of data packets has been accumulated at the interface from LAN to the WAN. Such a congestion is created when the interface within the LANCOM can submit fewer data to the WAN than data are delivered in peak periods from the LAN. This is e.g. the case, if the interface to the WAN is an integrated ADSL interface with comparatively low transmission speed ("upstream"). The integrated ADSL modem automatically reports back to the LANCOM how many data packets it is still able to receive, and thus brakes the data stream already within the router. As a result, the queues will automatically fill up.

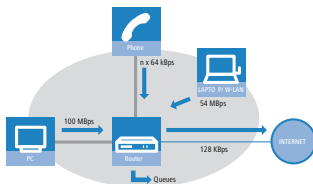

Different is the case, if an Ethernet interface represents the connection to the WAN. From the LANCOM's point of view, the connection to the Internet via an external broadband modem looks like an Ethernet segment. On the distance from the LANCOM to the DSL modem, data will be transferred with full LAN speed of 10 or 100 Mbps. Because of an equal input and output speed, no natural congestion will be produced then. Furthermore, the Ethernet between the LANCOM and the broadband modem does not report anything about the capacity of the connection. The consequence: a congestion will only be happen within the broadband modem. But because no queues are deployed therein, surplus data will be lost. Thus a prioritization of "preferred" data is not possible!

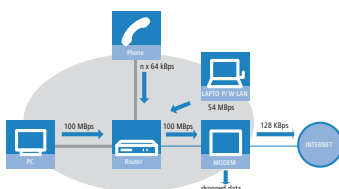

To solve this problem, the transfer rate of the LANCOM's WAN interface will be reduced artificially. This interface will thereby be adjusted to the transfer rate that is available for the actual data transport towards the WAN. For a standard DSL connection, the DSL interface is thus adjusted in the LANCOM to the appropriate upstream rate (e.g. 128 kbps).

Data rates indicated by providers are mostly likely net rates. The gross data rate, which is available for the interface is a little bit higher than the net data rate guaranteed by the provider. If you know the gross data rate of your provider,

you can enter this value for the interface and slightly increase in this way the data throughput. However, with entering the net data rate you play safe in any case!

### 10.3.2 Queues for receiving direction

Apart from the data transfer rate in transmission direction, the same consideration applies also to the receiving direction. Due to its 10 or 100 Mbps Ethernet interface, the LANCOM's WAN interface is fed by clearly fewer data from the broadband modem than would actually be receivable. All data packets received on the WAN interface are transferred to the LAN with equal rights.

In order to be able to prioritize incoming data as well, thus an artificial "brake" must be added also in this direction. Like already incorporated for the upstream direction, the data transfer rate of the interface is therefore adapted to the provider's offer in the downstream direction. For a standard DSL connection thus e.g. a downstream rate of 768 kbps applies. Again, the gross data rate can be entered here, if known.

Reducing the receiving bandwidth makes possible to treat received data packets suitably. Preferred data packets will be directly passed on to the LAN up to the guaranteed minimum bandwidth, all remaining data packets are running into congestion. This congestion produces generally a delayed confirmation of the packets. For a TCP connection, the sending server will react to this delay by reducing its sending frequency and adapting itself to the available bandwidth.

The following queues operate on the receiving side:

- Deferred Acknowledge Queue

Each WAN interface contains additionally a QoS reception queue, which takes up those packets that should be „slowed down“. The storage period of each individual packet depends on its length and on the actual permitted reception bandwidth on the receiving side. Packets with a minimum reception bandwidth assigned by a QoS rule are passing through without any further delay, as long as the minimum bandwidth is not exceeded.

- Standard reception queue

All packets that do not need special treatment because of an active QoS rule on the receiving side end up here. Packets of this queue are directly passed on resp. confirmed without consideration of maximum bandwidths.

## 10.4 Reducing the packet length

The preferential treatment of data packets belonging to important applications can be endangered - depending on the situation - by very long data packets of other applications. This is the case e.g. when IP telephony and a FTP data transfer are simultaneously active on the WAN connection.



The FTP transfer uses quite large data packets of 1500 byte, whereas, the Voice over IP connection sends packets of e.g. 24 byte net in relatively short intervals. If FTP packets are in the sending queue of the LANCOM just at the moment when a VoIP packet is to be transferred, then the VoIP packet can only be sent after the line is free again. Depending on the transfer rate of the connection, this may cause a noticeable delay of the speech transmission.

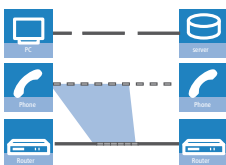

This annoying behavior can be compensated if all data packets, which are not belonging to the connection preferred by QoS, do not exceed a certain packet length. While doing so, the data packets of the FTP connection will be divided into

such small sections that the time-critical VoIP connection is able to deliver the packets without noticeable delay within the required time slots. A resulting delay has no disadvantageous effect to the TCP-secured FTP transfer.

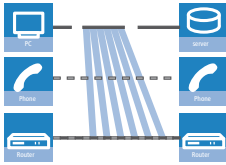

Two different procedures exist to influence the packet length:

- The LANCOM can inform the peers of a data connection that they should only send data packets up to a certain length. Thereby, an appropriate PMTU (Path Maximum Transmission Unit) is enforced on the sending side. This procedure is called "PMTU reduction".

The PMTU reduction can be used for sending as well as for receiving direction. For the sending direction, the data source of the own LAN is adjusted with the PMTU reduction to a smaller packet size, for the receiving direction the data source of the WAN, e.g. web or FTP servers in the Internet.

Provided that the data connection already exists when the VoIP connection is started, the senders regulate packet lengths very quickly to the permitted value. When setting up new data connections while a VoIP connection is already established, the maximum permitted packet length is negotiated directly during the connection phase.

! The reduced packet length on the data connection still remains also after terminating the VoIP connection, as long as the sender checks the PMTU value again.

- The LANCOM is able to split packets to be sent above an adjustable maximum size (e.g. 256 byte) into smaller units itself. But such a procedure called "fragmentation" is not supported by all servers of the Internet, because dealing with fragmented packets is considered as a security risk, and therefore is turned off by many servers. That's why disturbances can occur e.g. while downloading or while transmitting web pages.

Thus, this procedure is recommended only for connections without involving unknown servers, e.g. for a direct connection of branches to their head office via VPN connection, over which the Internet traffic is not running simultaneously.

## 10.5 QoS parameters for Voice over IP applications

An important task when configuring VoIP systems is to guarantee a sufficient voice quality. Two factors considerably influence the voice quality of a VoIP connection: The voice delay on its way from sender to addressee, as well as the loss of data packets, which do not arrive or do not arrive in time at the addressee. The "International Telecommunications Union" (ITU) has examined in extensive tests, what human beings perceive as sufficient voice quality, and has published as the result in the ITU G.114 recommendation.

For LANCOM devices with VoIP functions that were already integrated or added in with a software option, the QoS settings for SIP calls are defined automatically.

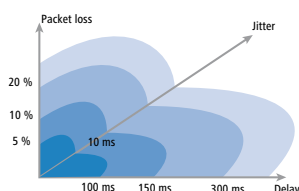

In case of a delay of not more than 100 ms, and a packet loss of less than 5%, the quality is felt like a "normal" telephone connection. In case of more than 150 ms delay and less than 10% packet loss, the telephone user perceives still a very

10 Quality of Service

good quality. Up to 300 ms and 20%, some listeners feel this quality like still suitable, beyond that the connection is considered as no more suitable for voice transmission.

Apart from the average delay time, also a variation in this delay is perceived by the human ear. Delay differences of the voice information from sender to addressee (jitter) are still tolerated up to 10 ms, and values beyond considered as irritating.

Accordingly, a VoIP connection should be configured such that the criteria for good speech quality are met: Packet loss up to 10%, delay up to 150 ms and jitter up to 10ms.

- Jitter can be removed in the receiving station by an appropriate buffer. In this buffer (jitter buffer) the packets are stored intermediately, and passed on at a constant rate to the addressee. By this intermediate buffering, the delay variations due to individual transmission times of the individual packets can be removed.
- The delay is influenced by several components:
  - Time of processing (packeting, coding and compression by the sender and the addressee), duration of handing over the packet from application to the interface (serialization), and the time for transmitting via the WAN distance (propagation) contribute to the fixed part of delay.
  - The variable part is determined by the jitter resp. by the setting of the jitter buffer.

These two parts together compose a delay, which should ideally not exceed 150 ms.

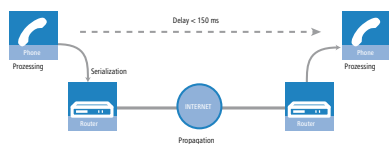

- Apart from the general loss by network transmission, the packet loss is significantly influenced by the jitter buffer. If packets arrive with a larger delay than it can be balanced by the jitter buffer, the packets will be discarded and will increase the packet loss. The larger the jitter buffer, the smaller is the loss. Conversely, the entire delay will increase with the jitter buffer size. That means for configuration, that the jitter buffer should be selected as small as the quality can be considered still as sufficient.

In detail, delay is determined especially by the codec used, the resulting packet size and the available bandwidth:

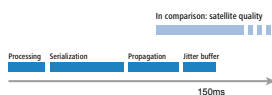

- The time for processing is determined by the used codec. For a sampling time of 20 ms, exactly each 20 ms a new packet is generated. Times for compression can mostly be neglected.

The time for handing over the packet to the interface is defined by the quotient of packet size and available bandwidth

:

	Packet size in bytes						
	1	64	128	256	512	1024	1500
56 Kbps	0,14	9	18	36	73	146	215
64 Kbps	0,13	8	16	32	64	128	187
128 Kbps	0,06	4	8	16	32	64	93
256 Kbps	0,03	2	4	8	16	32	47
512 Kbps	0,016	1	2	4	8	16	23
768 Kbps	0,010	0,6	1,3	2,6	5	11	16
1536 Kbps	0,005	0,3	0,6	1,3	3	5	8

A 512 byte packet of an FTP connection occupies the line at 128 Kbps upstream cablefor at least 32 ms.

Besides, the packets of the VoIP connection are often much larger than the pure net payload. The additional headers of the IP and Ethernet packets, as well eventual IPsec headers have to be added as well. The net load results from the product of net data rate and sampling time of the used codec. For all codecs, each 40 bytes UDP header and at least 20 bytes for the IPsec header must be added (RTP and IPsec headers can be larger, depending on the configuration).

Without IPsec	Payload	IP-Payload	Ethernet/PPPoE	ATMNetto Bps	ATMBrutto Bps
Code	20ms	20ms	20ms	20ms	20ms
G711-64	160	200	222	96000,0	106000,0
G722-64	160	200	222	96000,0	106000,0
G726-40	100	140	162	76800,0	84800,0
G726-32	80	120	142	76800,0	84800,0
G726-24	60	100	122	57600,0	63600,0
G726-16	40	80	102	57600,0	63600,0
G729-8	20	60	82	57600,0	63600,0
G723-6,3	16	56	78	38400,0	42400,0

Without IPsec	Payload	IP-Payload	Ethernet/PPPoE	ATMNetto Bps	ATMBrutto Bps
Code	30ms	30ms	30ms	30ms	30ms
G711-64	240	280	302	89510,4	98834,4
G722-64	240	280	302	89510,4	98834,4
G726-40	150	190	212	63936,0	70596,0
G726-32	120	160	182	63936,0	70596,0
G726-24	90	130	152	51148,8	56476,8
G726-16	60	100	122	38361,6	42357,6
G729-8	30	70	92	38361,6	42357,6
G723-6,3	24	64	86	38361,6	42357,6

With IPsec	Payload	IP-Payload	IPSEC-Payload	Ethernet/PPPoE	ATMNetto Bps	ATMBrutto Bps
Code	20ms	20ms	20ms	20ms	20ms	20ms
G711-64	160	200	260	282	134400,0	148400,0
G722-64	160	200	260	282	134400,0	148400,0
G726-40	100	140	200	222	96000,0	106000,0
G726-32	80	120	180	202	96000,0	106000,0
G726-24	60	100	160	182	96000,0	106000,0
G726-16	40	80	140	162	76800,0	84800,0
G729-8	20	60	120	142	76800,0	84800,0
G723-6,3	16	56	116	138	76800,0	84800,0

With IPsec	Payload	IP-Payload	IPSEC-Payload	Ethernet/PPPoE	ATMNetto Bps	ATMBrutto Bps
Code	30ms	30ms	30ms	30ms	30ms	30ms
G711-64	240	280	340	362	102297,6	112953,6
G722-64	240	280	340	362	102297,6	112953,6

With IPsec	Payload	IP-Payload	IPSEC-Payload	Ethernet/PPPoE	ATMNetto Bps	ATMBrutto Bps
G726-40	150	190	250	272	76723,2	84715,2
G726-32	120	160	220	242	76723,2	84715,2
G726-24	90	130	190	212	63936,0	70596,0
G726-16	60	100	160	182	63936,0	70596,0
G729-8	30	70	130	152	51148,8	56476,8
G723-6,3	24	64	124	146	51148,8	56476,8

- IP payload: Voice payload + 40 byte header (12 byte RTP; 8 byte UDP; 20 byte IP header)
  - IPsec payload: IP paket + padding + 2 byte (padding length & next header) = multiple of the IPsec initialization vector

⚠ The values in the table apply to the use of AES. With other encryption methods the resulting package may vary on a minor degree.

⚠ Further information on bandwidth requirements for Voice over IP with IPsec is available in the LANCOM techpaper Performance Analysis of LANCOM Routers.

- The time for transmission via Internet depends on the distance (about 1 ms per 200 km), and on the thereby passed routers (about 1 ms per hop). This time can be approximated by the half average ping time to the remote station.
- The jitter buffer can be adjusted directly at many IP telephones, e.g. as fixed number of packets, which should be used for buffering. The telephones load then up to 50% of the adjusted packets and begin afterwards to replay. The jitter buffer correspond therefore to half of the entered packets multiplied with the sampling time of the codec.
- Conclusion: The total delay is composed as follows for the according bandwidth, a ping time of 100 ms to the remote station and a jitter buffer of 4 packets for both codecs in this example:

Codec	Processing	Serialization	Propagation	Jitter buffer	Sum
G.723.1	30 ms	32 ms	50 ms	60 ms	172 ms
G.711	20 ms	32 ms	50 ms	40 ms	142 ms

- The transfer time of the packets to the interface (serialization) assumes a PMTU of 512 bytes on a 128 Kbps connection. Therefore, for slower interfaces or other codecs it is eventually necessary to adjust jitter buffers and/or PMTU values.

⚠ Please notice that the bandwidths are required in the sending and receiving direction, as well as just for one single connection.

## 10.6 QoS in sending or receiving direction

For controlling data transfer by means of QoS one can select whether the according rule applies to the sending or to the receiving direction. But which direction refers to sending and receiving for a given a data transfer depends on the particular point of view. The following two variants apply:

- The direction corresponds to the logical connection setup
- The direction corresponds to the physical data transfer over the appropriate interface

The differences are unveiled by looking at a FTP transfer. A client of the LAN is connected to the Internet through a LANCOM.

- During an active FTP session, the client sends by the PORT command the information to the server, on which port the DATA connection is expected. As the result, the server establishes the connection to the client and sends the



data in the same direction. In this case, the logical connection as well as the real data stream over the interface go from the server to the client, and the LANCOM takes both as the receiving direction.

- Different is the case of a passive FTP session. Here the client itself establishes the connection to the server. The logical connection setup thus is from client to server, but the data transmission over the physical interface flows in the reverse direction from server to client.

With standard settings, a LANCOM assumes the sending or receiving direction depending on the logical connection setup. Because such a point of view may not be easy to follow in certain application scenarios, the point of view can alternatively be changed to the flow of the physical data stream.

- ! The differentiation between sending and receiving direction applies only to the installation of maximum bandwidths. For a guaranteed minimum bandwidth, as well as for fragmentation and PMTU reduction always the physical data transfer via the respective interface applies as the direction!

## 10.7 QoS configuration

### 10.7.1 Evaluating ToS and DiffServ fields

#### ToS or DiffServ?

For configuration with LANconfig adjust on index card 'General' whether the 'Type of service field' or alternatively the 'DiffServ field' is to be observed for prioritization of data packets. When both options are turned off, the ToS/DiffServ field will be ignored.

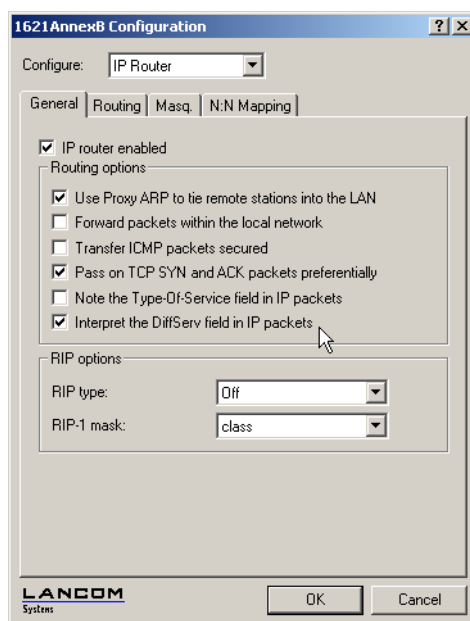

LANconfig: IP router / general / routing methods

WEBconfig: Setup / IP router / Routing method

Feature settings for routing method values are the following:

- **Standard:** The ToS/DiffServ field is ignored.
- **TOS:** The ToS/DiffServ field is considered as ToS field, the bits "Low delay" and "High reliability" will be evaluated.
- **DiffServ:** The ToS/DiffServ field is interpreted as DiffServ field and evaluated as follows:

DSCP code points	Kind of transmission
CSx (including CS0 = BE)	normal transmission
AFxx	secured transmission
EF	preferred transmission

## DiffServ in Firewall rules

The code points from the DiffServ field can be evaluated by Firewall rules for further control of QoS parameters such as minimum bandwidth or PMTU reduction.

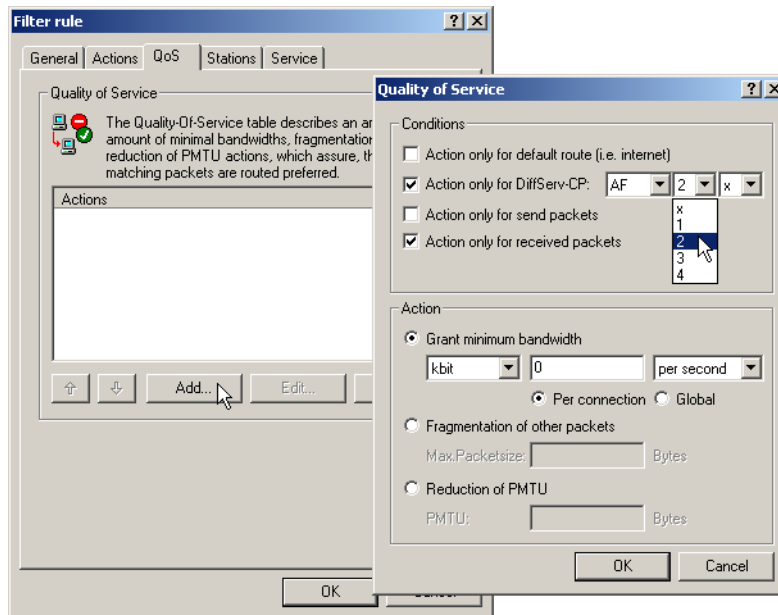

According to your selection of the DSCP type (BE, CS, AF, EF) the valid values can be adjusted in additional drop down lists. Alternatively, the DSCP decimal value can be entered directly. A table listing valid values can be found under .

LANconfig: Firewall/QoS / Rules / Filter rules / Quality of Service

WEBconfig: Setup / IP router / Firewall E Rule list

The Firewall rule is extended by condition "@d" and the DSCP (Differentiated Services Code Point). The code point can either be indicated with its name (CS0 - CS7, AF11 to AF 43, EF or BE) or its decimal resp. hexadecimal depiction. "Expedited Forwarding" can therefore be indicated as "@dEF", "@d46" or "@d0x2e". Furthermore, collective names (CSx resp. AFxx) are possible.

Examples:

- **%Lcds0 @dAFxx %A:** Accept (secured transmission) on DiffServ "AF", limit "0"
- **%Qcds32 @dEF:** Minimum bandwidth for DiffServ "EF" of 32 kbps
- **%Fprw256 @dEF:** PMTU reduction for reception for DiffServ "EF" to 256 bytes

These examples reserve a desired bandwidth for Voice over IP phone calls. The first element "%Lcds0 @dAFxx %A" accepts DSCP "AFxx" marked packets of signalling calls. Voice data marked with "EF" is transferred preferentially by the entry "%Qcds32 @dEF", and a bandwidth of 32 Kbps is guaranteed thereby as well. In parallel, the PMTU is reduced to 256 byte by "%Fprw256 @dEF", which enables ensuring the required bandwidth in receiving direction at all.

! Further information about defining Firewall rules can be found in chapter .

## 10.7.2 Defining minimum and maximum bandwidths

A minimum bandwidth for certain applications is defined in LANconfig by a Firewall rule according to the following conditions:

- The rule does not need an action, because QoS rules always implicitly assume “transfer” as action.
- The guaranteed bandwidth is defined on index card 'QoS'.

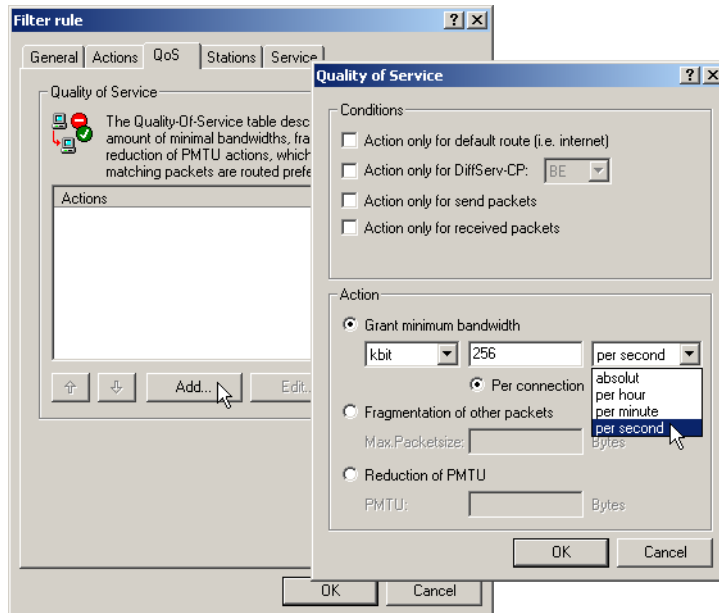

- The option 'Action only for default route' limits the rule to those packets, which are sent or received via default route.
  - The option 'Action only for VPN route' limits the rule to those packets, which are sent or received via VPN tunnel.
  - The option 'Forced' defines a static reservation of bandwidth. Bandwidth reserved in this way cannot be used for any other connections, even while the preferred connection is inactive.
  - The option 'Per connection' resp. 'Globally' specifies, whether the minimum bandwidth set here is valid for each single connection corresponding to this rule ('per connection'), or, if this should be the upper limit for the sum of all connections together ('globally').
- Like for other Firewall rules, index cards 'Stations' and 'Services' determine for which stations in the LAN / WAN and for which protocols this rule applies.

LANconfig: Firewall/QoS / Rules / Filter rules / Quality of Service

WEBconfig: Setup / IP router / Firewall / Rule list

A required minimum bandwidth is introduced by “%Q”. Here it is implicitly assumed that the respective rule is an “Accept” action, and that the packets will thus be transmitted.

A maximum bandwidth is simply defined by a limit rule, which discards by a “Drop” action all packets, which exceed the defined bandwidth.

Examples:

- **%Qcds32**: Minimum bandwidth of 32 kbps for each connection
- **%Lgds256 %d**: Maximum bandwidth of 256 kbps for all connections (globally)

! Further information about defining Firewall rules can be found in chapter .

### 10.7.3 Adjusting transfer rates for interfaces

**!** Devices with built-in ADSL/SDSL modem resp. with an ISDN adapter make these settings independently for the respective interface. For a LANCOM model with Ethernet **and** ISDN interface, these settings have to be made solely for the Ethernet interface.

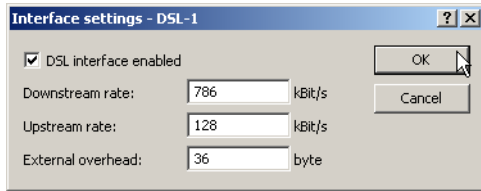

- An Ethernet WAN (DSL/cable) interface can be switched off completely in this dialogue.
- As upstream and downstream rate the gross data rates are entered, which are usually a little bit higher than the net data rates indicated by the provider as the guaranteed data rate (see also ).
- The “external overhead” considers information added to the packets during the data transfer. Concerning applications with small data packets (e.g. Voice over IP), this extra overhead is quite noticeable. Examples for the external overhead:

Transfer	External overhead	Note
PPPoEoA	36 bytes	additional headers, loss by not completely used ATM cells
PPTP	24 bytes	additional headers, loss by not completely used ATM cells
IPoA (LLC)	22 bytes	additional headers, loss by not completely used ATM cells
IPoA (VC-MUX)	18 bytes	additional headers, loss by not completely used ATM cells
Cable modem	0	direct transfer of Ethernet packets

LANconfig: Interfaces / WAN

WEBconfig: Setup / Interfaces / DSL Interfaces

**!** Only upstream and downstream rates are indicated by Kbps, external overhead in bytes/packet.

### 10.7.4 Sending and receiving direction

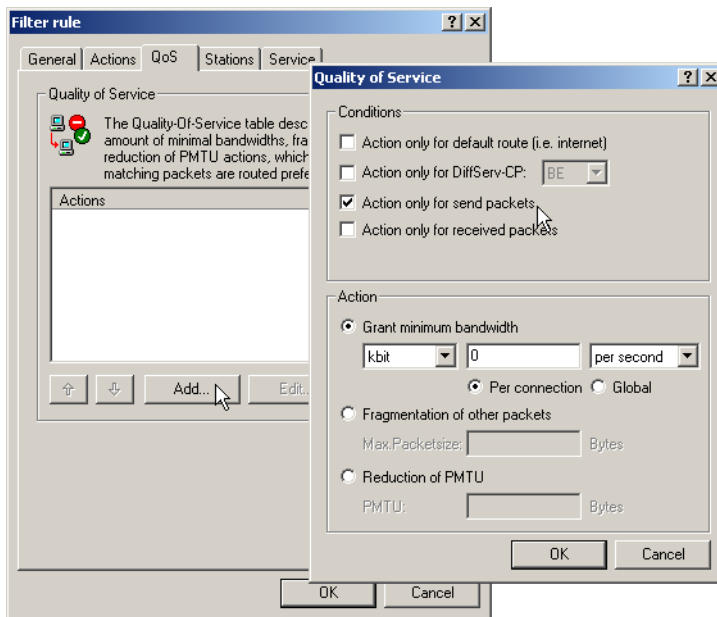

For configuration with WEBconfig or Telnet, the interpretation of the data transfer direction is specified in a new Firewall rule by parameters "R" for receive, "T" for transmit (send) and "W" for reference to the WAN interface:

LANconfig: Firewall/QoS / Rules / Filter rules / Quality of Service

WEBconfig: Setup / IP router / Firewall / Rule list

A restriction of data transfer to 16 Kbps in sending direction applying to the physical WAN interface is e.g. made by the following Firewall rule:

- %Lcdstw16%d

## 10.7.5 Reducing the packet length

The length reduction of the data packets is defined by a Firewall rule according to the following conditions:

- The reduction refers to **all** packets, which will be sent to the interface and which do **not** correspond to the rule.
- Not packets of certain protocols are reduced, rather than all packets globally on that interface

For LANCOM devices with VoIP functions that were already integrated or added in with a software option, fragmentation and PMTU reduction can be set separately for SIP calls.

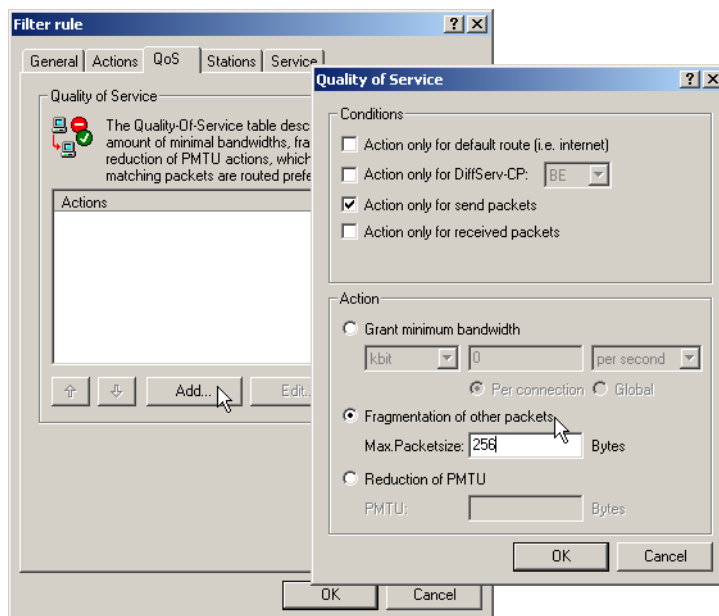

For configuration with WEBconfig or Telnet, the reduction is entered in a new Firewall rule by parameter "P" for PMTU reduction (Path MTU, MTU = Maximum Transmission Unit) and "F" for the fragment size.

LANconfig: Firewall/QoS / Rules / Filter rules / Quality of Service

WEBconfig: Setup / IP router / Firewall / Rule list

**!** PMTU reduction and fragmentation refer always to the physical connection. Indicating parameter "W" for WAN sending direction is not required here and hence will be ignored if existing.

The following example shows a setting for Voice over IP telephony:

Rule	Source	Destination	Action	Protocol
VOIP	IP addresses of IP telephones in the LAN, all ports	IP addresses of IP telephones in the LAN, all ports	%Qcds32 %Prt256	UDP

This rule defines the minimum bandwidth for sending and receiving to 32 Kbps, forces and reduces the PMTU while sending and receiving to packets of 256 byte size. For the TCP connection, the maximum segment size of the local

workstation is determined to 216, so that the server will send packets of maximum 256 byte (reduction of the PMTU in sending and receiving direction).

## 10.8 QoS for WLANs according to IEEE 802.11e (WMM/WME)

With the extension to the 802.11 standard, 802.11e, Quality of Service can be provided for transfers via WLAN. Among others, 802.11e supports the prioritization of certain data-packet types. This extension is an important basis for the use of voice applications in WLANs (Voice over WLAN, VoWLAN).

The WiFi alliance certifies products that support Quality of Service according to 802.11e, and refer to WMM (WiFi Multimedia, formerly known as WME or Wireless Multimedia Extension). WMM defines four categories (voice, video, best effort and background) which make up separate queues to be used for prioritization.

The 802.11e standard sets priorities by referring to the VLAN tags or, in the absence of these, by the DiffServ fields of IP packets. Delay times (jitter) are kept below 2 milliseconds, a magnitude which is inaudible to the human ear. 802.11e controls access to the transfer medium with EDCF, the Enhanced Distributed Coordination Function.

 Priorities can only be set if the WLAN client and the access point both support 802.11e or WMM, and also if the applications are able to mark the data packets with the corresponding priorities.

A LANCOM access point can activate 802.11e for each of its physical WLAN networks separately.

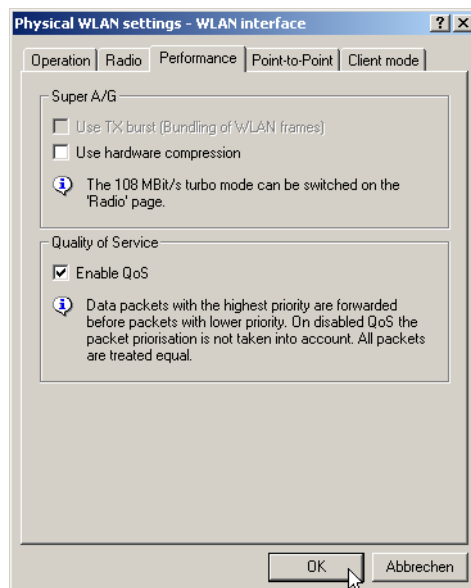

LANconfig: Interfaces / Wireless LAN / Physical WLAN settings / Performance

WEBconfig: LCOS menu tree / Setup / Interfaces / WLAN / Performance

## 11 Virtual Private Networks (VPN)

### 11.1 What does VPN offer?

A VPN (Virtual Private Network) can be used to set up cost-effective, public IP networks, for example via the Internet.

While this may sound unspectacular at first, in practice it has profound effects. To illustrate this, let's first look at a typical corporate network without VPN technology. In the second step, we will see how this network can be optimized by the deployment of VPN.

#### 11.1.1 Conventional network infrastructure

First, let's have a look at a typical network structure that can be found in this form or similar forms in many companies:

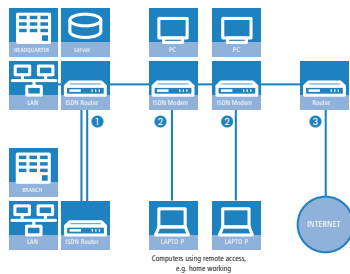

The corporate network is based on the internal network (LAN) in the headquarters. This LAN is connected to the outside world in three ways:

1. A subsidiary is connected to the LAN, typically using a leased line.
2. PCs dial into the central network via modem or ISDN connections (Remote Access Service – RAS).
3. The central LAN has a connection to the Internet so that its users can access the Web, and send and receive e-mail.

All connections to the outside world are based on dedicated lines, i. e. switched or leased lines. Dedicated lines are very reliable and secure. On the other hand, they involve high costs. In general, the costs for dedicated lines are dependent on the distance. Especially in the case of long-distance connections, keeping an eye out of cost-effective alternatives can be worthwhile.

The appropriate hardware must be available in the headquarters for every type of required connection (analog dial-up, ISDN, leased lines). In addition to the original investment costs, ongoing costs are also incurred for the administration and maintenance of this equipment.

### 11.1.2 Networking via the Internet

The following structure results when using the Internet instead of direct connections:

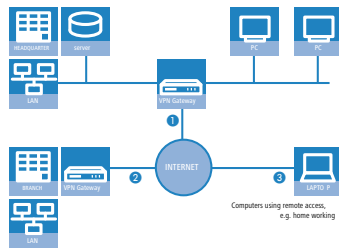

All participants have fixed or dial-up connections to the Internet. Expensive dedicated lines are no longer needed.

1. All that is required is the Internet connection of the LAN in the headquarters. Special switching devices or routers for dedicated lines to individual participants are superfluous.
2. The subsidiary also has its own connection to the Internet.
3. The RAS PCs connect to the headquarters LAN via the Internet.

The Internet is available virtually everywhere and typically has low access costs. Significant savings can thus be achieved in relation to switched or dedicated connections, especially over long distances.

The physical connection no longer exists directly between two participants; instead, the participants rely on their connection to the Internet. The access technology used is not relevant in this case: ideal is the use of broadband technologies such as DSL (Digital Subscriber Line) in combination with flatrate contracts. But also a conventional ISDN line can be used.

The technologies of the individual participants do not have to be compatible to one another, as would be the case for conventional direct connections. A single Internet access can be used to establish multiple simultaneous logical connections to a variety of remote stations.

The resulting savings and high flexibility makes the Internet (or any other IP network) an outstanding backbone for a corporate network.

Two technical properties of the IP standard speak against using the Internet as a part of a corporate network, however:

- The necessity of public IP addresses for all participants
- The lack of data security of unprotected data transfers

### 11.1.3 Private IP addresses on the Internet?

The IP standard defines two types of IP addresses: public and private. A public IP address is valid worldwide, while a private IP address only applies within a closed LAN.

Public IP addresses must be unique on a worldwide basis. Private IP addresses can occur any number of times worldwide; they must only be unique within their own closed network.

Normally, PCs in a LAN only have private IP addresses, while the router to the Internet also has a public address. All PCs behind this router have access to the Internet via its public IP address (IP masquerading). In such a case, only the router itself is responsive via the Internet. PCs behind the router are not responsive to the Internet without intervention by the router.

#### Routing at the IP level with VPN

IP connections must be established between routers with public IP addresses in order to link networks via the Internet. These routers provide the connections between multiple subnetworks. When a computer sends a packet to a private IP address in a remote network segment, the local router forwards the packet to the router of the remote network segment via the Internet.



The VPN gateway handles the conversion between private and public IP addresses. Without VPN, computers without public IP addresses would not be able to communicate with one another via the Internet.

### 11.1.4 Secure communications via the Internet?

The idea of using the Internet for corporate communications has been met with skepticism. The reason for this is that the Internet lies beyond a company's field of influence. Unlike dedicated connections, data on the Internet travels through the network structures of third parties that are frequently unknown to the company.

In addition, the Internet is based on a simple form of data transfer using unencrypted data packets. Third parties can monitor and perhaps even manipulate the contents of these packets. Anyone can access the Internet. As a result, third parties may gain unauthorized access to the transferred data.

#### VPN – Security through encryption

VPN was developed as a solution to this security problem. If necessary, it can encrypt the complete data communications between two participants. The packets are then unreadable for third parties.

The latest and most secure encryption technologies can be used for VPN. A very high level of security can thus be reached. VPN-protected data traffic via the Internet offers a degree of security that at least corresponds to that of dedicated lines.

Codes usually referred to as "keys" are agreed upon between the participants and used for data encryption. Only the participants in the VPN know these keys. Without a valid key, it is not possible to decrypt the data. They thus remain "private", inaccessible to unauthorized parties.

#### Send your data through the tunnel – for security's sake

This also explains the nature of a virtual private network: A fixed, physical connection between the devices of the type required for a direct connection does not exist at any time. Rather, the data flows via suitable routes through the Internet. With the proper technology, third parties can monitor and even record data traffic. As the packets are encrypted by VPN, the actual content of the packets is inaccessible. Experts compare this state to a tunnel: it's open at either end, but perfectly shielded in between. Secure connections within public IP networks are thus also referred to as "tunnels".



The goal of modern network structures has thus been achieved: secure connections via the largest and most low-cost public IP network: the Internet.

## 11.2 LANCOM VPN: an overview

### 11.2.1 VPN example application

VPN connections are used in many different fields of application. In most cases, a variety of communications technologies is used for transferring both data and audio, and VPN unites these systems into an integrated network. The following example illustrates a typical application that is often used in practice.

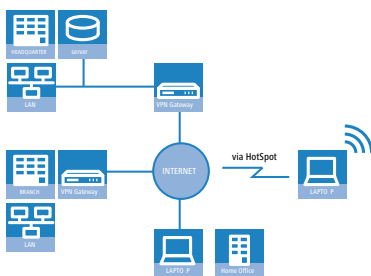

The principal components and features of these applications:

- The coupling of networks, for example between headquarters and a branch office
- Connecting external locations without fixed IP addresses via VPN router
- Connecting home offices without fixed IPs via ISDN or analog modems
- Connecting to Voice-over-IP telephone exchanges
- Connecting mobile users, for example when using public WLAN access

### 11.2.2 LANCOM VPN functions

This section lists all of the functions and properties of LANCOM VPN. This overview will provide a great deal of information for VPN experts. It is very compact, but contains a lot of complex, specialized terminology. Knowledge of the technical basics of VPN are required to understand this section. Don't worry: it's no problem if you skip this section. The information contained here is not required to set up and use LANCOM VPN.

- VPN in accordance with IPSec standard
- VPN tunnel via leased lines, switched connections and IP networks
- IPSec main and aggressive mode
- LANCOM Dynamic VPN: Public IP addresses can be static or dynamic (initiation of a connection towards remote sites with dynamic IP addresses requires ISDN)
- IPSec protocols AH, ESP and IPCOMP in transport and tunnel mode
- Hash algorithms:
  - HMAC-MD5-96, Hash length 128 bit
  - HMAC-SHA-1-96, Hash length 160 bit
- Symmetrical encryption methods
  - AES, key length 128, 192 and 256 bit
  - Triple-DES, key length 168 bit
  - Blowfish, key length 128 - 448 bit
  - CAST, key length 128 bit
  - DES, key length 56 bit
- IKE Config Mode
- IKE key exchange with Preshared Keys
- IKE with RSA signature and digital certificates (X.509)
- Key exchange via Oakley, Diffie-Hellman algorithm with key lengths 768 bit, 1024 bit or 1536 bit, well-known groups 1, 2 and 5
- Key management in accordance with ISAKMP
- Apart from conventional IPSec implementations, LANCOM devices offer extended functionality, such as the LANCOM Dynamic VPN that allows the use of the high-security IKE Main Mode even with dynamic IP addresses.
- In combination with the LANCOM Advanced VPN Client, a separate pre-shared key can be used for each connection even when using IKE Aggressive Mode connections.

## 11.3 VPN connections in detail

Two types of VPN connections are available:

- VPN connections linking two local networks. This type of connection is also known as a "LAN-LAN coupling".
- The connection of an individual computer with a network, generally via a dial-in connection (Remote Access Service – RAS).

### 11.3.1 LAN-LAN coupling

The coupling of two remote networks is known as a LAN-LAN coupling. With such a connection, the devices in one LAN can access those of the remote LAN (assuming they have the necessary access rights).

In practice, LAN-LAN couplings are frequently used between company headquarters and subsidiaries, or for connections to partner companies.

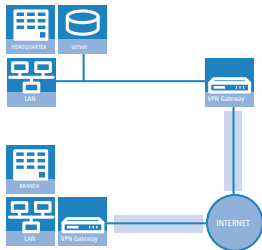

A VPN-enabled router (VPN gateway) is located at either end of the tunnel. The configuration of both VPN gateways must be matched to one another.

The connections are transparent for the remaining devices in the local networks, i. e., they appear to have a direct connection. Only the two gateways must be configured for the VPN connection.

#### Internet access in parallel

The Internet access for VPN can be used simultaneously for other Internet applications, such as web-browsing or e-mail. For security reasons, the parallel Internet access may be unwanted in some cases. For instance, if a branch office should be enforced to access the Internet only via a central firewall. For such applications the parallel Internet access can be disabled as well.

### 11.3.2 Dial-in connections (Remote Access Service)

Individual remote computers (hosts) can access the resources of the LAN via dial-up connections. Practical examples of this are employees working from home or field staff that dial into the company network.

If the dial-up connection of an individual computer to a LAN is to be realized via VPN, that computer first connects to the Internet. A special VPN client software then sets up a tunnel to the VPN gateway of the LAN using this Internet connection.

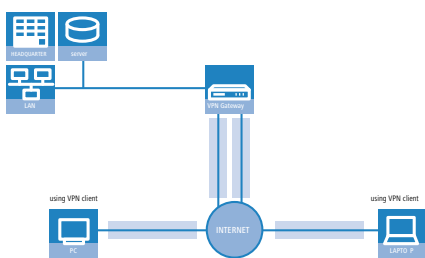

The VPN gateway of the LAN must support the establishment of VPN tunnels with the VPN client software of the remote PC.

## 11.4 What is LANCOM Dynamic VPN ?

LANCOM Dynamic VPN is a LANCOM Systems technology which permits VPN tunnels to be connected to remote stations that do not have a static, but only a dynamic IP address.

Who needs LANCOM Dynamic VPN and how does it work? We will answer this question in two steps: First, a look at the basics of IP addressing will show the problem of static IP addresses. The second step shows the solution thereof with LANCOM Dynamic VPN.

### 11.4.1 A look at IP addressing

Every participant on the Internet needs an IP address. Participants even need a special kind of IP address - a public one. The administration of public IP addresses is handled from central locations in the Internet. Each public IP address may only occur once on the entire Internet.

Local IP-based networks do not use public, but private IP addresses. For this reason, a number of address ranges within the entire IP address range have been reserved for private IP addresses.

A computer connected to both a local network and directly to the Internet therefore has two IP addresses: a public one for communication with the rest of the Internet and a private one by which the computer can be reached within the local network.

#### Static and dynamic IP addresses

Public IP addresses must be applied for and managed, which involves costs. There is also only a limited number of public IP addresses. For this reason, not every Internet user has his or her own fixed (static) IP address.

The alternative to static IP addresses are the so-called dynamic IP addresses. A dynamic IP address is assigned to an Internet user by the Internet Service Provider (ISP) upon dialling-in, and remains valid for the duration of the connection. The ISP takes an unused address selected at random from their pool of IP addresses. This IP address is only temporarily assigned to the user for the duration of a given connection. When the connection is ended, the IP address is once again free and the ISP can assign it to another user.

Many flatrate connections, too, are realised with via dynamic IP addresses. Every 24 hours or so, the connection is forcibly interrupted. The new connection is generally assigned with a new and different IP address.

#### Advantages and disadvantages of dynamic IP addresses

This process has a very important advantage for ISPs: they only need relatively small pools of IP addresses. Dynamic IP addresses are also favorable for users: it's not necessary for them to apply for static IP addresses in advance - they can connect to the Internet immediately. It's also not necessary for them to manage IP addresses. This saves trouble and costs. The other side of the coin: A user without a static IP address cannot be addressed directly from the Internet.

This is a major problem when setting up VPNs. If, for example, Computer A would like to communicate with Computer B using a VPN tunnel on the Internet, Computer A needs the remote computer's IP address. If B only has a dynamic address, A cannot know that address and therefore cannot contact B.

The LANCOM Dynamic VPN offers the answer here.

### 11.4.2 This is how LANCOM Dynamic VPN works

Let's use two examples to explain how LANCOM Dynamic VPN works (designations refer to the IP addressing type of the two VPN gateways):

- dynamic – static
- static – dynamic
- dynamic – dynamic

#### Dynamic – static

If a user on computer B in LAN 2 wishes to connect to computer A in LAN 1, then gateway 2 receives a request and tries to establish a VPN tunnel to gateway 1. Gateway 1 has a static IP address and can be directly contacted over the Internet.

A problem arises in that the IP address from gateway 2 is assigned dynamically, and gateway 2 must communicate its current IP address to gateway 1 when attempting to connect. In this case, LANCOM Dynamic VPN takes care of transmitting the IP address during connection establishment.

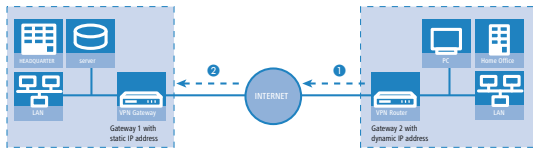

1. Gateway 2 connects to the Internet and is assigned a dynamic IP address.
2. Gateway 2 contacts Gateway 1 via its known public IP address. LANCOM Dynamic VPN enables the identification and transmission of the actual IP address of Gateway 2. Gateway 1 initiates the VPN tunnel then.

The great advantage of LANCOM devices with this application: Instead of the "Aggressive Mode" that is normally used when connecting VPN clients to the headquarters, the far more secure "Main Mode" can be applied. Although with Main Mode more unencrypted messages can be exchanged during the IKE handshake, the method is overall more secure than Aggressive Mode.

⚠ An ISDN line is not necessary for establishing this type of connection. The dynamic end communicates its IP address encrypted via the Internet protocol ICMP (or alternatively via UDP).

### Static – dynamic

If, on the other hand, computer A in LAN 1 requires a connection to computer B in LAN 2, for example when headquarters carries out remote maintenance at the external locations, then gateway 1 receives the request and attempts to establish a VPN tunnel to gateway 2. Gateway 2 only has a dynamic IP address and cannot be directly contacted over the Internet.

With LANCOM Dynamic VPN, the VPN tunnel can be set up nevertheless. The connection is established in three steps:

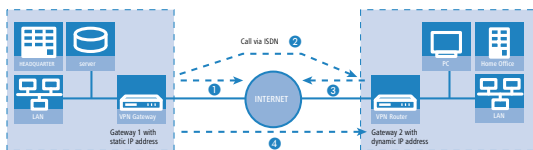

1. Gateway 1 calls Gateway 2 via ISDN. It takes advantage of the ISDN functionality of sending its own subscriber number via the D-channel free of charge. Gateway 2 determines the IP address of Gateway 1 from the preconfigured VPN remote stations using the received subscriber number.

If Gateway 2 does not receive a subscriber number via the D-channel (if that particular ISDN service feature is not available, for example) or an unknown number is transferred, the authentication will be performed via the B-channel. Once the negotiation was successful, Gateway 1 sends its IP address and closes the connection on the B-channel immediately.

2. Now it's Gateway 2's turn: It first connects to its ISP and is assigned a dynamic IP address.
3. Gateway 2 authenticates itself at Gateway 1. The static IP address of gateway 1 is known, of course.
4. Gateway 1 now knows the address of Gateway 2 and sets up the VPN tunnel to Gateway 2.

The advantage of LANCOM devices, for example when connecting from the headquarters to branch offices: The functions in LANCOM Dynamic VPN also allows access to networks without a flatrate, i.e. networks that are not always online. The ISDN connection and an associated MSN act to substitute the another address, such as a static IP address or the dynamic address translation via dynamic DNS services, a solution often used with flatrate connections.

⚠ The described connection set up requires an ISDN connection for both VPN gateways. But usually no charges will arise for this procedure.

⚠ Please note .

## Dynamic – dynamic

With LANCOM Dynamic VPN, VPN tunnels can also be set up between two gateways that both only have dynamic IP addresses. Let's modify the previous example so that in this case Gateway 1 also has a dynamic IP address. Once again, Computer A would like to connect to Computer B:

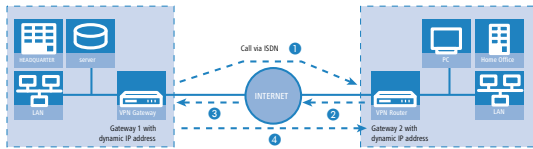

1. Gateway 1 connects to its ISP and is assigned a public, dynamic IP address.
  2. It then calls Gateway 2 via ISDN to send this dynamic address. Three procedures are used to send the address:
    - **As information in the LLC element of the D-channel.** In the D-channel protocol of Euro-ISDN (DSS-1), the so-called LLC (**L**ower **L**ayer **C**ompatibilty) element can be used to send additional information to the remote station. This transfer takes place before the B-channel connection is established. Once the address has been sent successfully, the remote station rejects the call. Charges are thus not incurred for a B-channel connection. The IP address is sent nevertheless for free in this case.
- 
- ! The LLC element is generally available as a standard feature in Euro-ISDN that does not require registration or activation. It may be disabled by telephone companies or individual exchanges, however. The LLC element is not available in 1TR6, the German national ISDN. The procedure described above thus will not work with 1TR6.

  - As a subaddress via the D-channel. If it is not possible to send the address via the LLC element, Gateway 1 will attempt to send the address as a so-called subaddress. Like the LLC element, the subaddress is an information element of the D-channel protocol that permits short items of information to be sent free of charge. In this case, the telephone company must enable the 'subaddressing' feature first; this is generally subject to a charge. As with the LLC element, the call is rejected by the remote station once the IP address has been transferred successfully. The connection thus remains free of charge.
  - Via the B-channel. If both attempts to send the IP address via the D-channel fail, then a conventional connection via the B-channel must be established to send the IP address. The connection is dropped immediately after the IP address has been sent. This connection is subject to the usual charges.
3. Gateway 2 connects to the ISP and receives a dynamic IP address.
  4. Gateway 2 authenticates itself at Gateway 1. The static IP address of gateway 1 is known, of course.
  5. Gateway 1 now knows the address of Gateway 2 and sets up the VPN tunnel to Gateway 2.

---

! Dynamic VPN works only between LANCOM that each feature at least one ISDN port that can be used for the ISDN connection.

! Please note ..

## Dynamic IP addresses and DynDNS

It is also possible to establish a connection between two stations using dynamic IP addresses by using so-called dynamic DNS services (DynDNS). The address of the tunnel end-point is not defined as an IP number (which is, of course, dynamic and subject to frequent change) but as a static name instead (e.g. MyLANCOM@DynDNS.org).

Two things are needed for translating a name to its current IP address: A dynamic DNS server and a dynamic DNS client:

- The first, available from numerous providers in the Internet, is a server that is in communication with Internet DNS servers.

- The dynamic DNS client is integrated in the device. It can make contact to any one of a number of dynamic-DNS service providers and, assuming that a user account has been set up, automatically update its current IP address for the DNS name translation. This can be set up very conveniently with a Wizard under LANconfig (also see ):

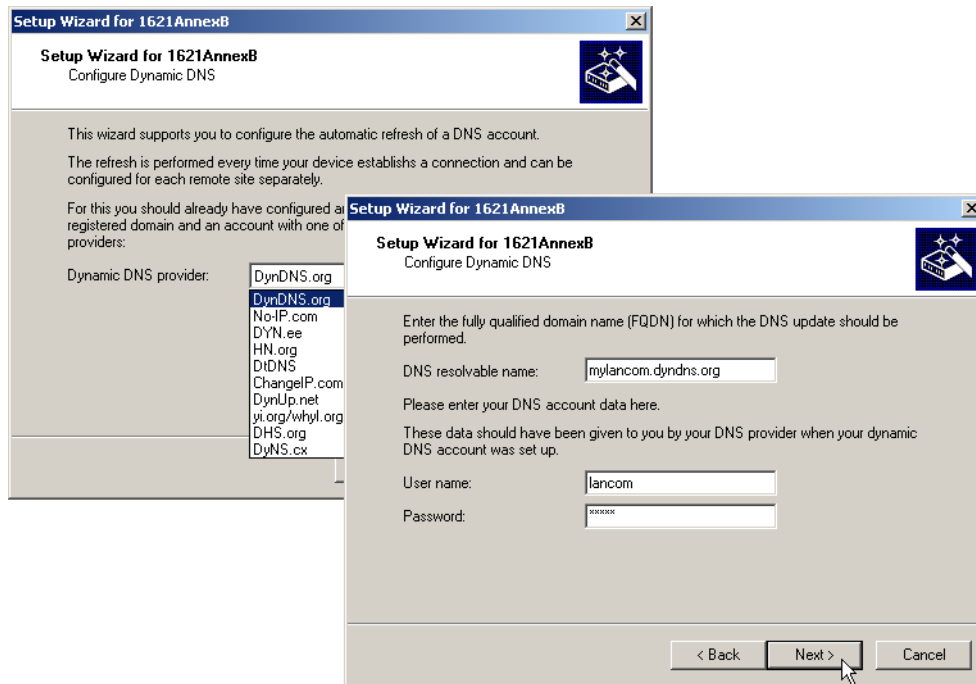

- ⓘ For reasons of security and availability, LANCOM Systems recommends the use of Dynamic VPN in preference to dynamic DNS-based VPN solutions. Dynamic VPN is based on direct connections via the ISDN network and ensures a higher degree of availability than dynamic DNS services in the Internet.

### 11.4.3 Information to the Dynamic VPN registration

When using dynamic VPN with IP address transmission over ISDN you must activate this feature. This operating mode is usually then required, when you configure a VPN tunnel with dynamic IP addresses on both sides without dynamic DNS services. All other operation modes of dynamic VPN (for transmitting the IP address by ICMP, to provoke a callback etc.) do **not** require a registration.

The registration is anonymous, i.e. no personal or firm data is transmitted.

- ⓘ The registration of the dynamic VPN option requires administrator rights.

When scanning the device for instance right after the program start LANconfig automatically recognizes if the device must be activated. After confirming the arising hint the LANconfig automatically transmits the required data of the device

to the registration server of LANCOM Systems. The release code is automatically transmitted back to the device and activated. The state of this procedure is visible in LANconfig.

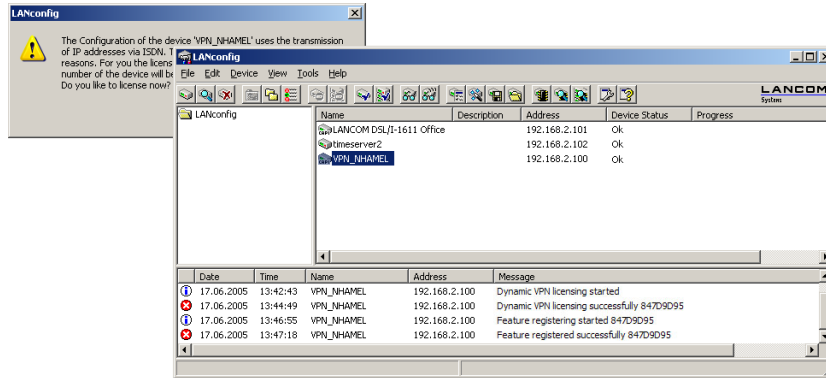

For the registration with WEBconfig the serial number of the device is required. You can find this information on the bottom side of your device.

**Dynamic-VPN registration**

The Configuration of this device uses the transmission of IP addresses via ISDN. This function must be licensed for legal reasons. The license is free of charge.

[Register dynamic VPN option](#)

**Setup Wizards**

Wizards enable you to handle frequent configurations.

- [Basic Settings](#)
- [Security Settings](#)
- [Set up Internet connection](#)
- [Selection of Internet Provider](#)

**Dynaymic VPN registration**

---

Dear customer,

please use this form to activate your LANCOM dynamic VPN feature only if you use it with IP address transmission over ISDN. This happens when you configure a VPN tunnel with **dynamic IP addresses on both sides without dynamic DNS services**. When you send the registration, you will receive the activation code for the device whose serial number you have submitted for registration.

**The 16 digits long charge number or 12 digits long serial number (depends on your device) can be found underneath your device. Please enter the appropriate number into the field router serial or charge number (12 or 16 digits). The 12 digits long serial number is also displayed in the status line of LANconfig, if the device is selected.**

Please take care to fill in the serial or charge number without any mistake. Your information will of course be treated as confidential. In case your registration was not successful or you have other problems during the registration you can trustfully turn to our product support via email to [optionsupport@lancom.de](mailto:optionsupport@lancom.de) for advice.

Router serial or charge number

When using WEBconfig you can find a link on the first page which leads you to the registering server of LANCOM Systems. There you must enter the serial number of your device and your e-mail address. After transmitting the data you receive a release code for the device.

To load this release code into your router, please proceed as follows:

Log on with administrator rights on WEBconfig. Select **Enable Software Option**, which is placed on the entry page. On the following page enter the release code and confirm by clicking on **Apply**.

## 11.5 Configuration of VPN connections

Three questions are answered in the configuration of VPN connections:

- Between which VPN gateways (remote stations) is the connection established?
- What security parameters are used to secure the VPN tunnel between the two gateways?



- Which networks or computers can intercommunicate via these tunnels?

**!** This section introduces the basic considerations for configuring VPN connections. Considered first of all is the simple connection of two local networks. Special cases such as dialling in to LANs with individual computers (RAS) or the connection of structured networks will be covered subsequently.

### 11.5.1 VPN tunnel: Connections between VPN gateways

Virtual Private Networks (VPNs) are used to interconnect local networks over the Internet. This involves the routing of the private LAN IP addresses via an Internet connection between two gateways with public IP addresses.

For the secure routing of private IP addresses over the Internet, a VPN connection, also known as a VPN tunnel, is established between the two LANs.

The VPN tunnel has two important tasks:

- To shield the transported data from unauthorized access
- To route private IP addresses via an Internet connection that can normally only be used to route public IP addresses.

The VPN connection between the two gateways is defined by the following parameters:

- The end-points of the tunnel, the VPN gateways, each of which are accessible via public IP addresses (static or dynamic)
- The IP connection between the two gateways
- The private IP address range that are to be routed between the VPN gateways
- Setting relevant to security, such as passwords, IPSec keys etc. to shield the VPN tunnel

This information is contained in the so-called VPN rules.

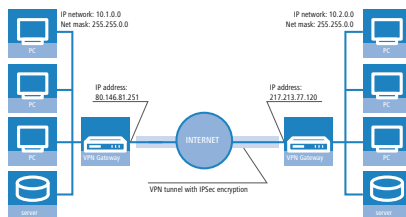

### 11.5.2 Set up VPN connections with the Setup Wizard

If possible, make use of the Setup Wizard within LANconfig to set up VPN connections between local networks. The Wizard guides you through the configuration and makes all the necessary settings for you. Carry out the configuration on both routers, one after the other.

1. Choose your device from the selection window in LANconfig and select the **Setup Wizard** button or use the menu bar **Tools / Setup Wizard**.

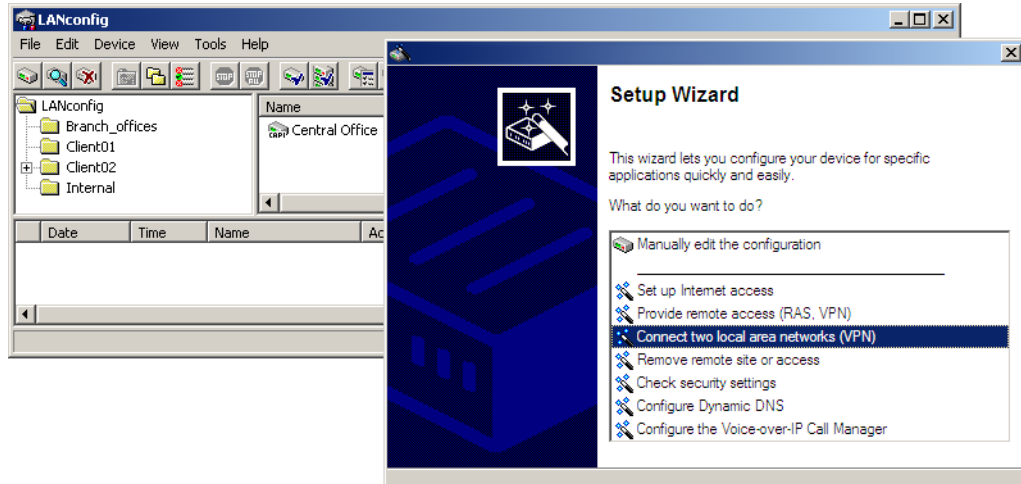

1. Follow the Wizard's instructions and enter the necessary data. The Wizard will inform you when the required information is complete. You can then close the Wizard with **Finish**.
2. Once you have completed the set-up of both routers, you can start testing the network connection. Try to communicate with a computer in the remote LAN (e. g. with ping). The device should automatically connect to the remote station and make contact to the requested computer.

This Wizard automatically sets up the VPN connections essential for typical LAN-LAN coupling. In the following situations, the VPN connections will have to be configured manually:

- Where no Windows computer with LANconfig is available. In this case, the necessary parameters are set with WEBconfig or via the Telnet console.
- Where only selected portions of the LAN (intranet) are to communicate with other computers via the VPN connection. This is the case where, for example, the intranet is connected to further subnets with routers, or when only selected portions of the intranet should have access to the VPN connection. In such cases, additional parameters are defined supplementary to those entered in the Setup Wizard.
- Configuring VPN connections to third-party devices.

### 11.5.3 1-Click-VPN for networks (site-to-site)

The site-to-site coupling of networks is now very simple with the help of the 1-Click-VPN wizard. It is even possible to simultaneously couple multiple routers to a central network.

1. In LANconfig, mark the routers at branch offices which are to be coupled to a central router via VPN.
2. Use drag&drop by mouse to place the devices onto the entry for the central router.

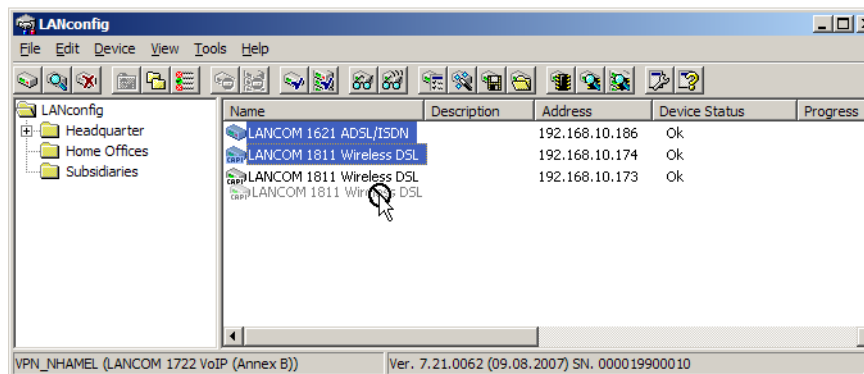

1. The 1-Click-VPN Site-to-Site Wizard will be started. Enter a name for this access and select the address under which the router is accessible from the Internet.

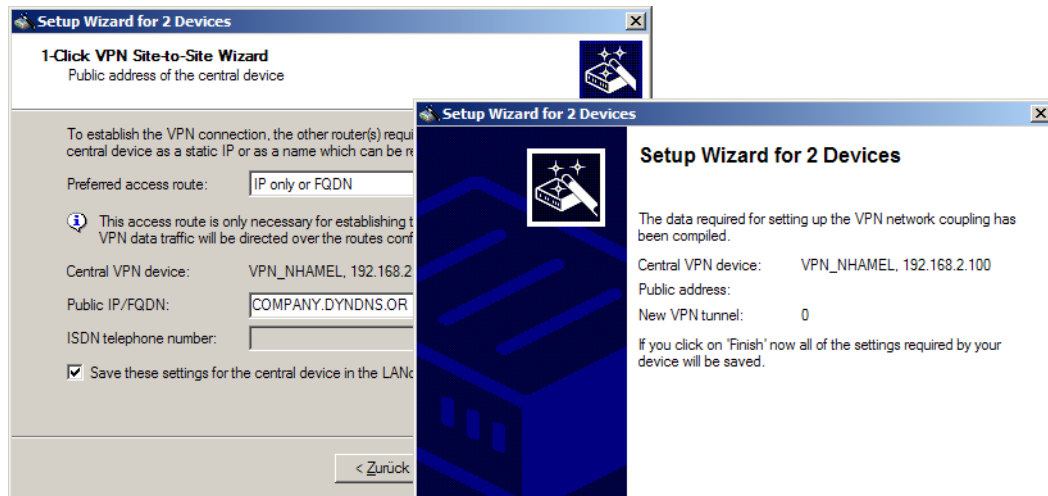

1. Select whether connection establishment is to take place via the name or IP address of the central router, or via an ISDN connection. Enter the address or name of the central router, or its ISDN number.
2. The final step is to define how the networks are to intercommunicate:
  - The INTRANET at headquarters only is to be provided to the branch offices.
  - All private networks at the branch offices can also be connected to one another via headquarters.

! All entries for the central device are made just once and are then stored to the device properties.

### 11.5.4 1-Click-VPN for LANCOM Advanced VPN Client

VPN accesses for employees who dial into the network with the LANCOM Advanced VPN Client are very easy to set up with the Setup Wizard and exported to a file. This file can then be imported as a profile by the LANCOM Advanced VPN Client. All of the information about the LANCOM VPN Router's configuration is also included, and then supplemented with randomly generated values (e.g. for the preshared key).

1. Use LANconfig to start the 'Set up a RAS Account' wizard and select the 'VPN connection'.
2. Activate the options 'LANCOM Advanced VPN Client' and 'Speed up configuration with 1-Click-VPN'.
3. Enter a name for this access and select the address under which the router is accessible from the Internet.
4. In the final step you can select how the access data is to be entered:
  - Save profile as an import file for the LANCOM Advanced VPN Client
  - Send profile via e-mail
  - Print out profile

! Sending a profile via e-mail could be a security risk should the e-mail be intercepted en route!

To send the profile via e-mail, the device configuration must be set up with an SMTP account with the necessary access data. Further, the configuration computer requires an e-mail program that is set up as the standard e-mail application and that can be used by other applications to send e-mails.

When setting up the VPN access, certain settings are made to optimize operations with the LANCOM Advanced VPN Client, including:

- Gateway: If defined in the LANCOM VPN Router, a DynDNS name is used here, or alternatively the IP address
- FQUN: Combination of the name of the connection, a sequential number and the internal domain in the LANCOM VPN Router.

## 11 Virtual Private Networks (VPN)

- Domain: If defined in the LANCOM VPN Router, the internal domain is used here, or alternatively a DynDNS name or IP address
- VPN IP networks: All IP networks defined in the device as type 'Intranet'.
- Preshared key: Randomly generated key 16 ASCII characters long.
- Connection medium: The LAN is used to establish connections.
- VoIP prioritization: VoIP prioritization is activated as standard.
- Exchange mode: The exchange mode to be used is 'Aggressive Mode'.
- IKE config mode: The IKE config mode is activated, the IP address information for the LANCOM Advanced VPN Client is automatically assigned by the LANCOM VPN Router.

### 11.5.5 Inspect VPN rules

VPN rules represent a combination of various pieces of information and they are not directly defined in a LANCOM device; instead, they are compiled from a variety of sources. This is why it is not possible to inspect the VPN rules with LANconfig or any other configuration tool.

Information about the current VPN rules in the device can be retrieved with the Telnet console. Start a Telnet connection to the VPN gateway and enter the command **show vpn** in the console:

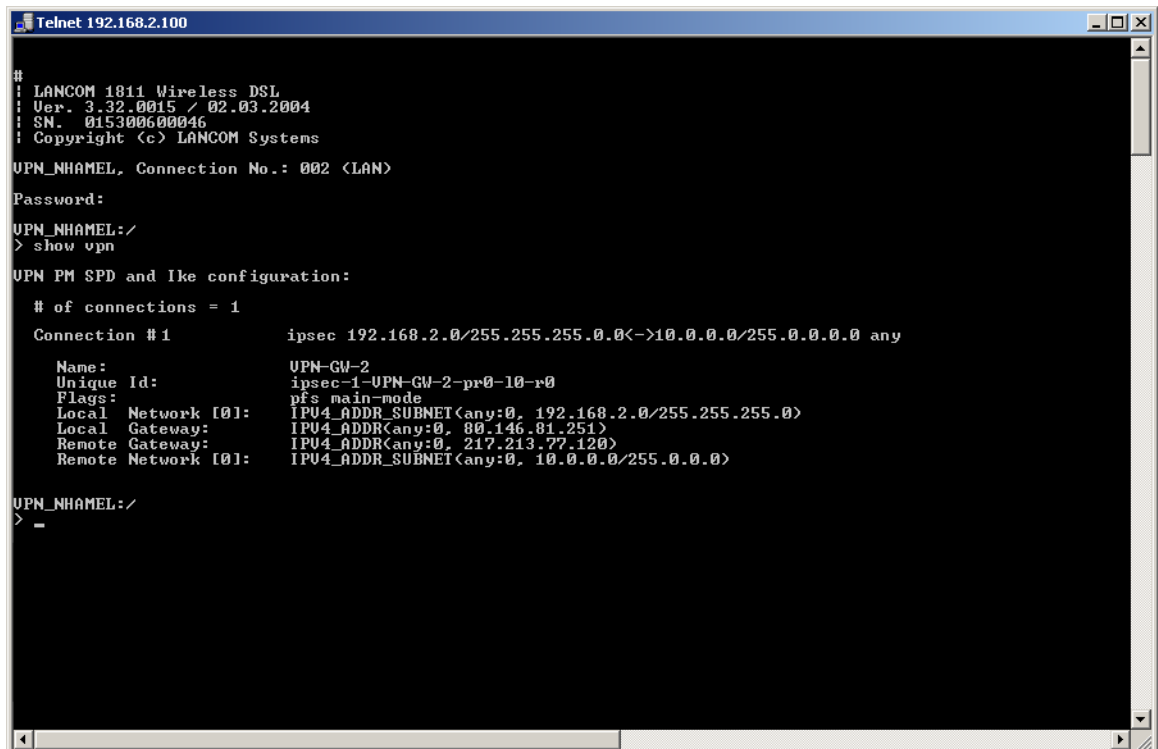

```

Telnet 192.168.2.100
#
: LANCOM 1811 Wireless DSL
: Ver. 3.32.0015 / 02.03.2004
: SN. 015300600046
: Copyright (c) LANCOM Systems
UPN_NHAMEL, Connection No.: 002 (LAN)
Password:
UPN_NHAMEL:/
> show vpn
UPN PM SPD and Ike configuration:
of connections = 1
Connection # 1 ipsec 192.168.2.0/255.255.255.0<->10.0.0.0/255.0.0.0 any
Name: UPN-GW-2
Unique Id: ipsec-1-UPN-GW-2-pr0-10-r0
Flags: pfs main-mode
Local Network [0]: IPV4_ADDR_SUBNET<any:0, 192.168.2.0/255.255.255.0>
Local Gateway: IPV4_ADDR<any:0, 80.146.81.251>
Remote Gateway: IPV4_ADDR<any:0, 217.213.77.120>
Remote Network [0]: IPV4_ADDR_SUBNET<any:0, 10.0.0.0/255.0.0.0>
UPN_NHAMEL:/
> -

```

The output informs you of the network relationships that are relevant to VPN connections to other networks.

In this example, the local network at a branch office (network 192.168.2.0, netmask 255.255.255.0) is connected to the network at the headquarters (network 10.0.0.0, netmask 255.255.255.0). The public IP address of the local gateway is 80.146.81.251, and that of the remote VPN gateway is 217.213.77.120.

! Entering "any:0" displays the protocols and ports that can be used over the connection.

Further output is displayed by the command "show vpn long". The information displayed here covers network relationships and also the parameters that are relevant to security, such as IKE and IPSec proposals.

## 11.5.6 Manually setting up VPN connections

Manually setting up VPN connections involves the tasks described previously:

- Definition of the tunnel endpoints
- Definition of the security-related parameters (IKE and IPSec)
- Definition of the VPN network relationships, i.e. the IP address ranges to be connected. Should the IP ranges overlap at both ends of the connection, please refer to the section .
- When coupling Windows networks (NetBIOS/IP): Without WINS servers at both ends of the VPN connection (such as when linking a home office), the LANCOM can take over the necessary NetBIOS proxy functions. To this end, the NetBIOS module in the LANCOM must be activated, and the corresponding VPN remote site must be entered into the NetBIOS module as the remote site. Should WINS servers be present in both of the coupled networks, then the NetBIOS module should be deactivated so that the LANCOM does not perform NetBIOS proxy functions.



To use the LANCOM NetBIOX proxy either LANCOM Dynamic VPN must be applied, because it transmits the required addresses, or the IP address of the remote station as a primary NBNS must be entered in the IP parameter list (\-LANconfig: Communication / Protocols).

- When using LANCOM Dynamic VPN: Entry for the corresponding remote site in the PPP list with a suitable password for the Dynamic VPN handshake. The username entered here must correspond with the name entered in the remote device that describes the VPN connection to this local device. Activate "IP routing". If Windows networks are also to be coupled, then the NetBIOS entry should be activated here.

The tunnel endpoints, i.e. the local VPN gateway and each of the VPN remote stations, are entered into the VPN connection list.

Manually configuring the VPN connection involves the following steps:

1. Create an entry for the remote VPN gateway in the connection list and enter its public IP address.
2. The security parameters for the VPN connection are normally taken from the prepared list, and all that is required here is to define an IKE key.
3. For a Dynamic VPN connection, create a new entry in the PPP list with the name of the remote VPN gateway as the remote station, with the name of the local VPN gateway as the User Name, and set a suitable password. Be sure to activate the IP routing for this PPP connection and, if required, the routing of "NetBIOS over IP" as well. The remaining PPP parameters, such as the procedure for checking the remote station, can be defined in the same way as for other PPP connections.
4. The main task in setting up VPN connections is in defining the network relationships. Which IP address ranges at each end of the VPN tunnel should be included in the secured connection?

## 11.5.7 IKE config mode

When configuring VPN dial-in connections, there is as an alternative to fixed IP addresses for the remote stations that dial in, in that a pool of IP addresses can be made available to them. To this end, the "IKE-CFG" mode is additionally added to the entries in the connection list. This can assume the following values:

- **Server:** With this setting, the device functions as the server for this VPN connection. The assignment of an IP address to the client can take place in two ways:
  - If the remote site is entered in the routing table, the IP address defined here will be assigned to the client.
  - If the remote site is not entered in the routing table, an IP address which is available from the IP pool will be taken for the dial-in connections.

- ! The remote site must be configured as IKE-CFG client in this case, and thus has to request an IP address from the server. To dial in with a LANCOM Advanced VPN Client, the option **Use IKE Config Mode** has to be activated in the connection profile.

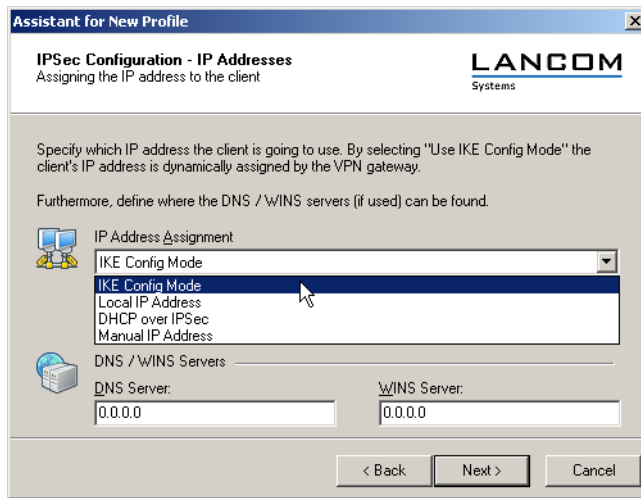

- **Client:** With this setting, the device functions as the client for this VPN connection and requests an IP address from the remote site (server). The device acts in a similar manner to a VPN client.
- **Off:** If the IKE-CFG mode is switched off, no IP addresses will be assigned for the connection. Fixed IP addresses must be defined for both ends of the connection.

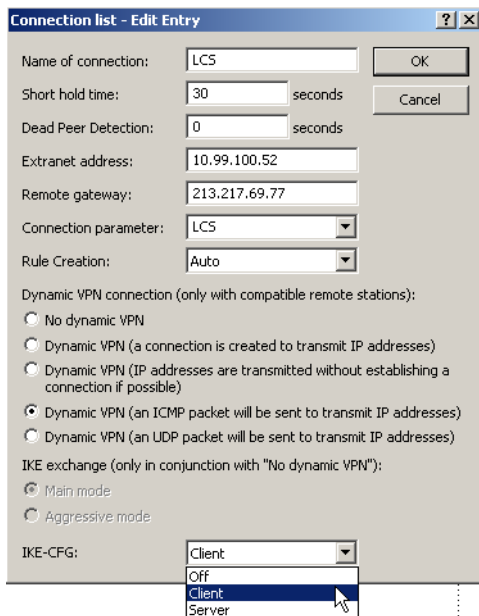

LANconfig: VPN / General / Connection list

WEBconfig: LCOS menu tree / Setup / VPN E VPN-Peers

### 11.5.8 Prepare VPN network relationships

The firewall integrated into LANCOM routers is a powerful instrument for defining source and target address ranges between which data transfer (and limitations to it) can be enabled or prohibited. These functions are also used for setting up the network relationships for the VPN rules.

In the simplest case, the firewall can generate the VPN rules automatically.

- The local intranet serves as the source network, i.e. the same private IP address range that the local VPN gateway itself belongs to.
- For automatically generated VPN rules, the target networks are those network ranges that have a remote VPN gateway set as their router.

To activate the automated rule generation, simply switch on the corresponding option in the firewall automatic when using the VPN installation Wizard under LANconfig. When coupling two simple local networks, the automatic VPN can interpret the necessary network relationships from the IP address range in its own LAN and from the entry for the remote LAN in the IP routing table.

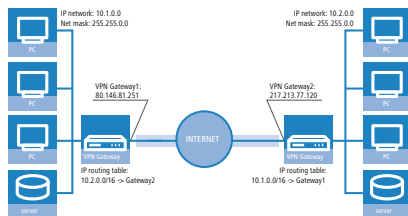

The description of the network relationships is more complicated if the source and target networks are not only represented by the intranet address ranges of the connected LANs:

- When only a portion of the local intranet is to be available to the remote network, then the automatic method is unsuited as the IP address range that is open to the VPN connection is too large.

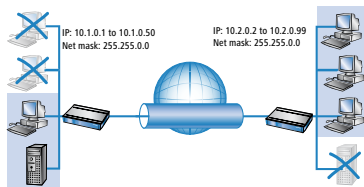

- In many network structures, the local network is connected by further routers to sections of other networks with their own IP address ranges. Additional settings are required to include these address ranges in the network relationship.

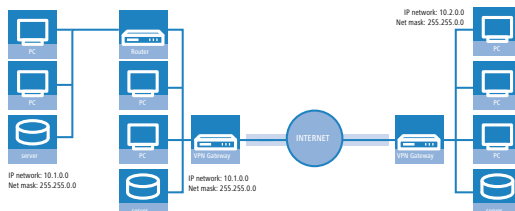

In these cases, the network relationships that describe the source and target networks must be entered manually. Depending on the situation, the scope of the automatically generated VPN rules may be extended, although sometimes it is better to deactivate the automatic VPN system to prevent unwanted network relationships.

The necessary network relationships are defined by the appropriate firewall rules under the following circumstances:

- In the firewall rules, the option "Consider this rule when generating VPN rules" must be activated.



The firewall rules for generating VPN rules are active even when the actual firewall function in the LANCOM device is not required and is switched off!

- Make sure that the firewall action is set to "Transfer".
- Sources and targets for the connection can be entered as individual stations, certain IP address ranges, or whole IP networks.



It is vital that target networks are defined in the IP routing table so that the router in the LANCOM devices can forward the appropriate data packets to the other network. You can make use of the entries that already exist there and simply enter a higher-level network as the target. The intersecting portion of the target network

defined by the firewall and the subordinate entries in the IP routing table is integrated into the network relationships for the VPN rules.

**Example:** The target networks 10.2.1.0/24, 10.2.2.0/24 and 10.2.3.0/24 are entered into the IP routing table and can be accessed via the router VPN-GW 2. An entry for the target network 10.2.0.0/16 is sufficient for these three subnets to be included in the VPN rules.

! The definition of source and target networks must agree at both ends of the VPN connection. It is not possible, for example, to map a larger target address range to a smaller source address range at the opposite end. Decisive here are the IP address ranges allowed by the VPN rules and not the networks defined in the firewall rules. These can be very different from the network relationships in the VPN rules because of the intersecting ranges.

- VPN connections can also be limited to certain services or protocols according to your requirements. This means that the VPN connection can be limited to use only with a Windows network, for example.

! These limitation should be defined by a separate set of rules that applies only to the firewall and that will not be used in generating VPN rules. Combined firewall/VPN rules can very quickly become highly complex and difficult to comprehend.

### 11.5.9 Configuration with LANconfig

The section demonstrates how LANconfig can be used to configure a LAN-LAN coupling with additional subnets. In this section, VPN gateway 1 will be configured and then the configuration of gateway 2 with the help of WEBconfig will be demonstrated.

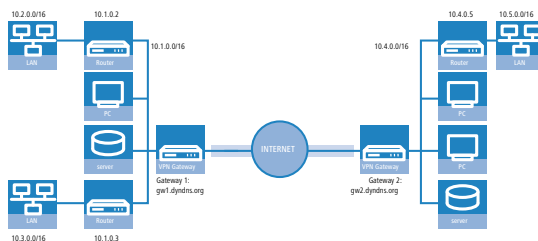

1. When configuring VPN, access the "IKE param." tab and create a new IKE key for the connection:

IKE key - New Entry	
Identification:	<input type="text" value="IKE-KEY-1"/>
Preshared secret:	<input type="text" value="*****"/>
Local identity type:	<input type="text" value="No identity"/>
Local identity:	<input type="text"/>
Remote identity type:	<input type="text" value="No identity"/>
Remote identity:	<input type="text"/>



- Under the “General” tab, create a new entry in the list of Connection parameters. Select the IKE key created earlier for this. PFS and IKE groups can also be selected in the same way as IKE and IPSec proposals from the options prepared earlier.

- You should then generate a new entry in the Connection list with the name of the remote gateway as “name for the connection”. For LANCOM Dynamic VPN connections the entry “Remote gateway” must remain empty. Otherwise enter the public address of the remote station: either the fixed IP address or the name for translation by DNS.

- When using LANCOM Dynamic VPN: Change to the “Communication” configuration area. Using the “Protocols” tab, make a new entry in the PPP list. Select the remote VPN gateway as the remote site, enter the User Name as the

11 Virtual Private Networks (VPN)

name of the VPN connection that the remote VPN gateway uses to address the local device, and enter a suitable password that is identical at both locations, but for safety reasons should not be identical to the pre-shared key.

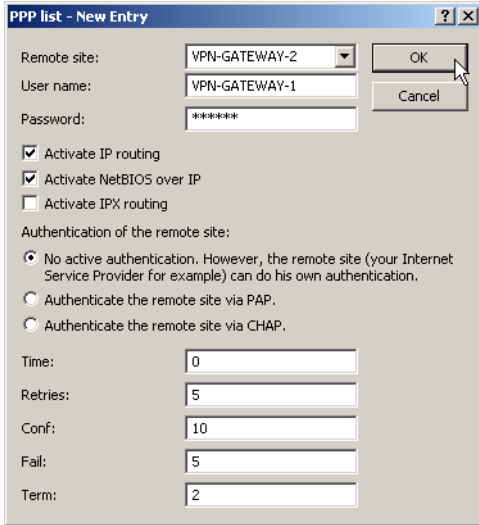

1. Be sure to activate "IP routing" and, if required, "NetBIOS over IP".
2. Change to the "IP Router" configuration area. On the "Routing" tab, make a new entry in the routing table for those parts of networks that are to be accessible in the remote and in the local LAN. In each case, define the router as the remote VPN gateway and switch the IP masquerading off.

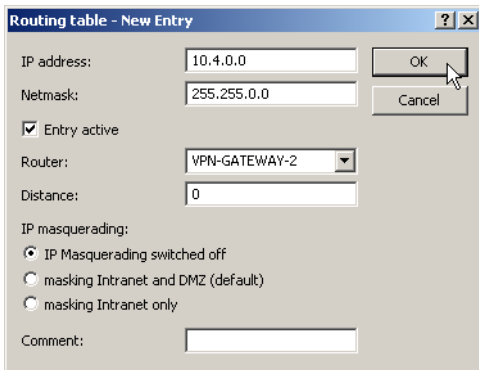

1. For the "VPN gateway 1", the following entries are necessary so that the remote network sections can be reached.

IP address	Net mask	Router	IP masquerading
10.4.0.0	255.255.0.0	VPN gateway 2	No
10.5.0.0	255.255.0.0	VPN gateway 2	No

For those subnetworks connected to your own LAN, define the router as the IP address for the appropriate LAN router.

IP address	Net mask	Router	IP masquerading
10.2.0.0	255.255.0.0	10.1.0.2	No
10.3.0.0	255.255.0.0	10.1.0.3	No

These entries enable VPN gateway 1 to forward packets arriving from the remote network to the correct sections of the local network.

- Change to the "Firewall/QoS" configuration area. On the "Rules" tab, add a new firewall rule with the name "VPN GATEWAY 1 OUT" and activate the option "This rule is used to create VPN rules". This ensures that IP networks described in this rule will be used in establishing VPN network relationships.

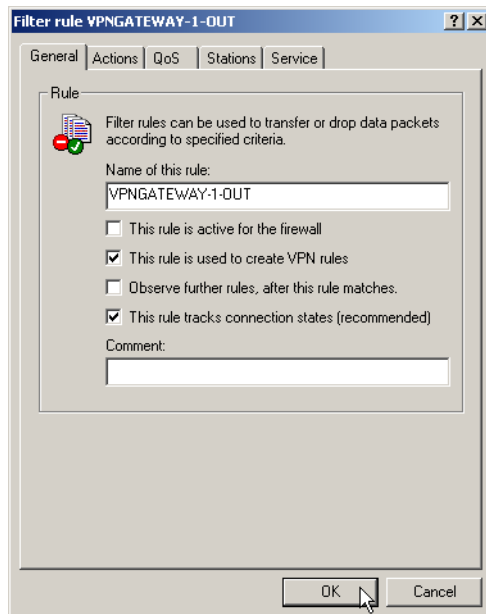

- ! It is recommended to keep the rules used for making network relationships (source and target IP) separate from those firewall rules that for instance affect the services used in communications. Combining both aspects can lead to a higher number of internal managed VPN relationships and therefore to a loss of performance in the VPN tunnels.

- On the "Actions" tab for these firewall rules, set the "Packet Action" to "Transmit".

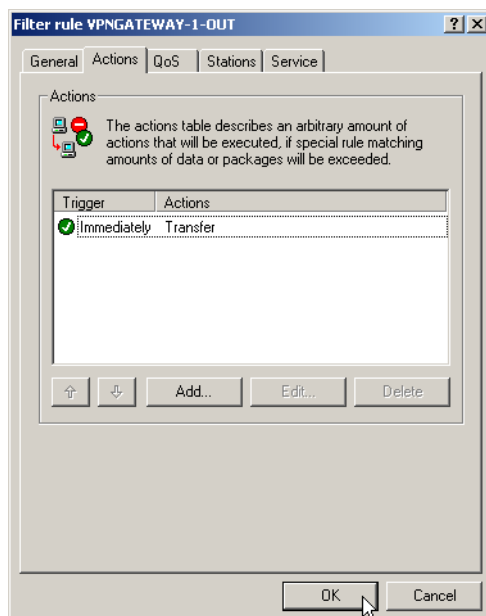

## 11 Virtual Private Networks (VPN)

1. On the "Stations" tab for these firewall rules, define the source of the data transfers as the subnets at the local site, and set the destination as all of the subnets at the remote site.

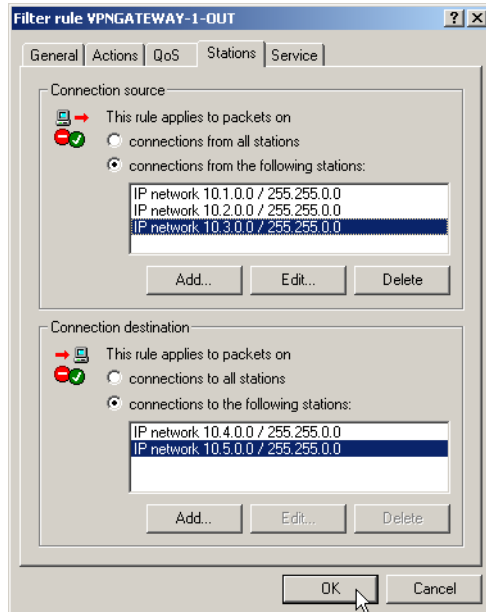

1. Now for the incoming data transmissions, generate a firewall rule named "VPN GATEWAY 1 IN" with the same parameters as the rule just described. The only difference is that the source and the destination networks are swapped.

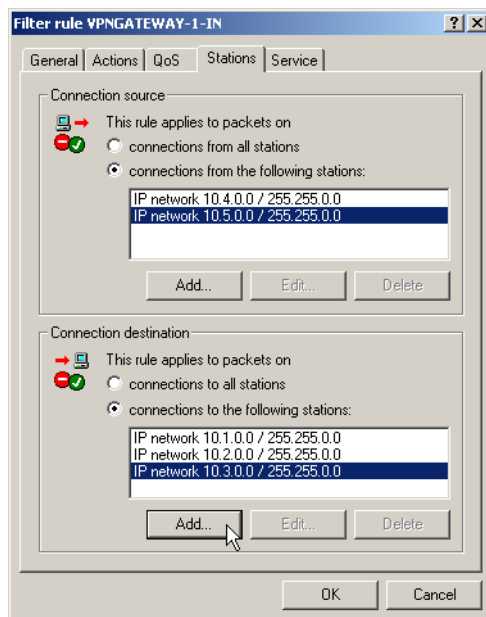

## 11.5.10 Configuration with WEBconfig

- Under **Configuration / VPN / IKE-Param. / IKE key** set a new IKE key for the connection:

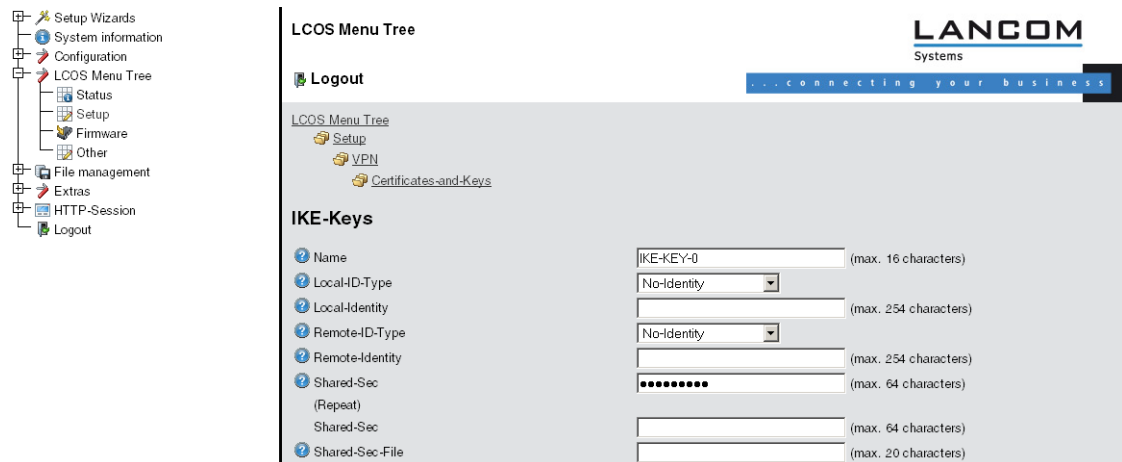

**LCOS Menu Tree**

**LANCOM Systems**  
... connecting your business

**Logout**

**LCOS Menu Tree**

- Setup
- VPN
- Certificates and Keys

**IKE-Keys**

Name	<input type="text" value="IKE-KEY-0"/>	(max. 16 characters)
Local-ID-Type	<input type="text" value="No-Identity"/>	
Local-Identity	<input type="text"/>	(max. 254 characters)
Remote-ID-Type	<input type="text" value="No-Identity"/>	
Remote-Identity	<input type="text"/>	(max. 254 characters)
Shared-Sec (Repeat)	<input type="text" value="*****"/>	(max. 64 characters)
Shared-Sec	<input type="text"/>	(max. 64 characters)
Shared-Sec-File	<input type="text"/>	(max. 20 characters)

- Under **Configuration / VPN / General / Connection parameters** define a new "VPN layer" for the connection parameters. Select the IKE key created earlier for this.

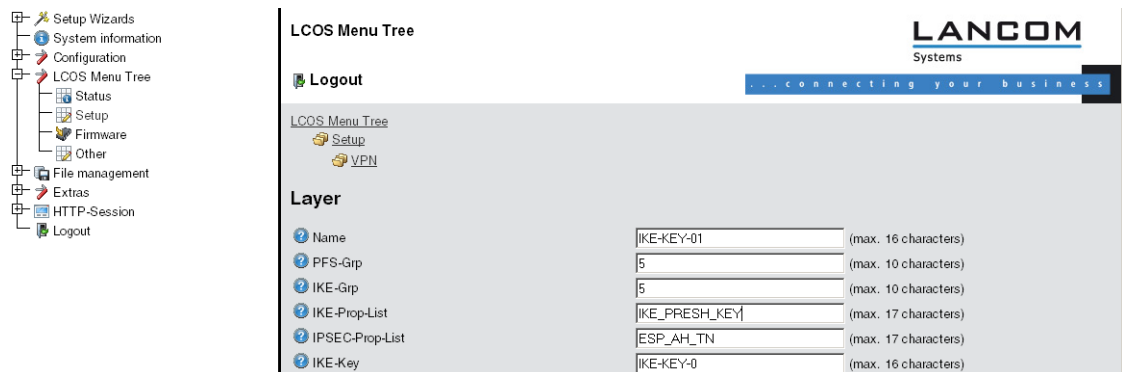

**LCOS Menu Tree**

**LANCOM Systems**  
... connecting your business

**Logout**

**LCOS Menu Tree**

- Setup
- VPN

**Layer**

Name	<input type="text" value="IKE-KEY-01"/>	(max. 16 characters)
PFS-Grp	<input type="text" value="5"/>	(max. 10 characters)
IKE-Grp	<input type="text" value="5"/>	(max. 10 characters)
IKE-Prop-List	<input type="text" value="IKE_PRESH_KEY"/>	(max. 17 characters)
IPSEC-Prop-List	<input type="text" value="ESP_AH_TN"/>	(max. 17 characters)
IKE-Key	<input type="text" value="IKE-KEY-0"/>	(max. 16 characters)

- Under **Configuration / VPN / Connection list** generate a new entry with the name of the remote gateway set to "Name". For the "Remote gateway", enter the public address of the remote station: either the fixed IP address or the name for translation by DNS.

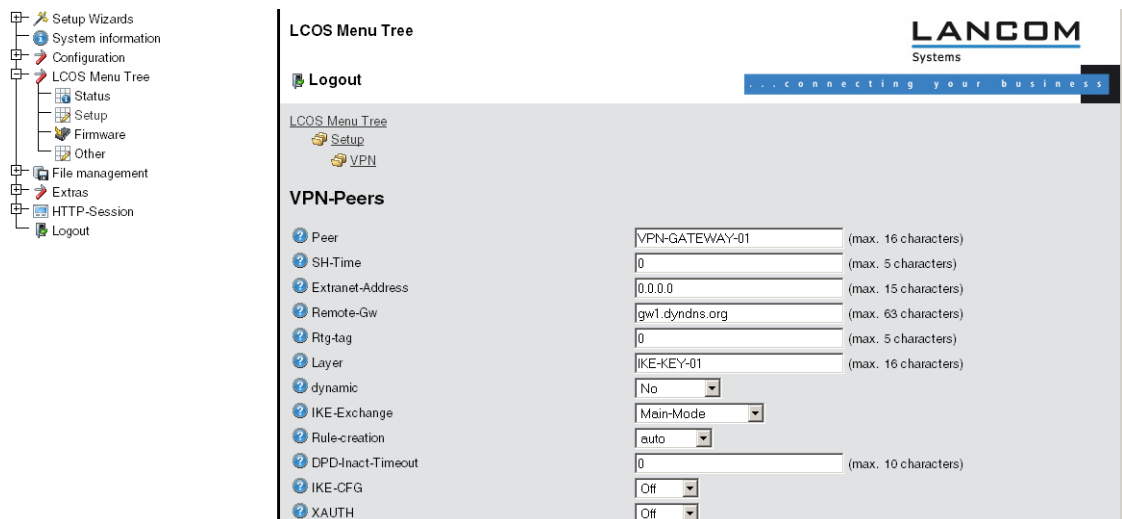

**LCOS Menu Tree**

**LANCOM Systems**  
... connecting your business

**Logout**

**LCOS Menu Tree**

- Setup
- VPN

**VPN-Peers**

Peer	<input type="text" value="VPN-GATEWAY-01"/>	(max. 16 characters)
SH-Time	<input type="text" value="0"/>	(max. 5 characters)
Extranet-Address	<input type="text" value="0.0.0.0"/>	(max. 15 characters)
Remote-Gw	<input type="text" value="gw1.dyndns.org"/>	(max. 63 characters)
Rtg-tag	<input type="text" value="0"/>	(max. 5 characters)
Layer	<input type="text" value="IKE-KEY-01"/>	(max. 16 characters)
dynamic	<input type="text" value="No"/>	
IKE-Exchange	<input type="text" value="Main-Mode"/>	
Rule-creation	<input type="text" value="auto"/>	
DPD-Inact-Timeout	<input type="text" value="0"/>	(max. 10 characters)
IKE-CFG	<input type="text" value="Off"/>	
XAUTH	<input type="text" value="Off"/>	

11 Virtual Private Networks (VPN)

- When using LANCOM Dynamic VPN: Under **Configuration / Setup / WAN module / PPP list** make a new entry. Select the remote VPN gateway as the remote site, enter the User Name as the name of the VPN connection that the remote VPN gateway uses to address the local device, and enter a suitable password that is identical at both locations.

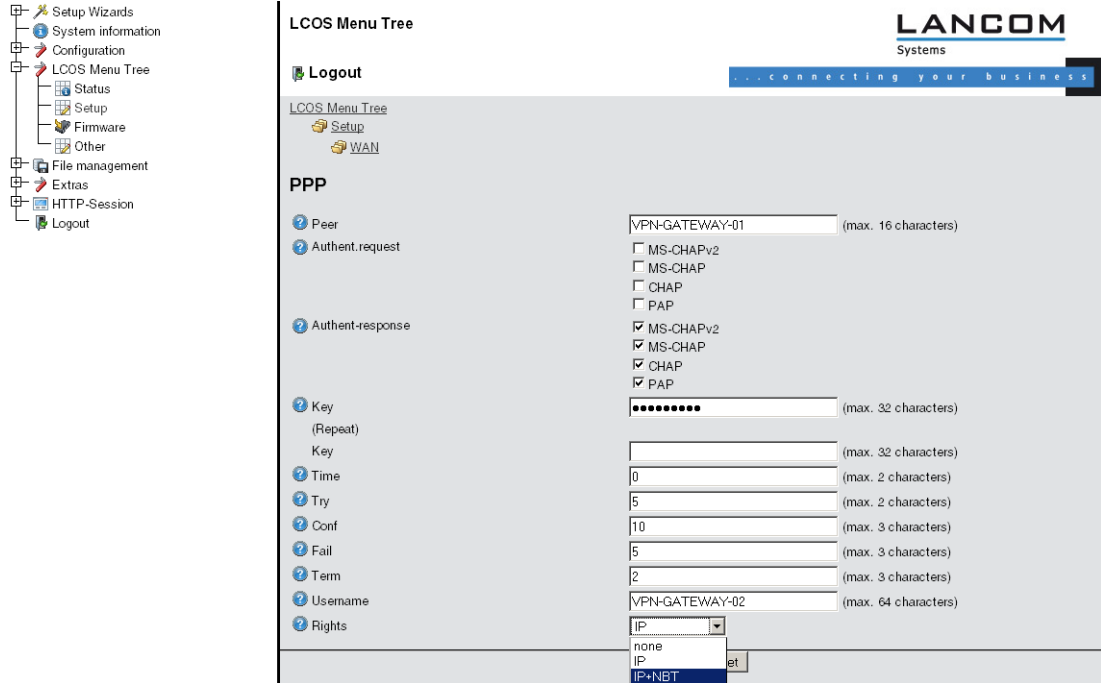

- Be sure to activate "IP routing" and, if required, "NetBIOS over IP".
- Under **Configuration / Setup / IP router module / IP routing table** generate a new entry for each network portion that should be accessible in the remote and in the local LAN. In each case, define the router as the remote VPN gateway and switch the IP masquerading off.

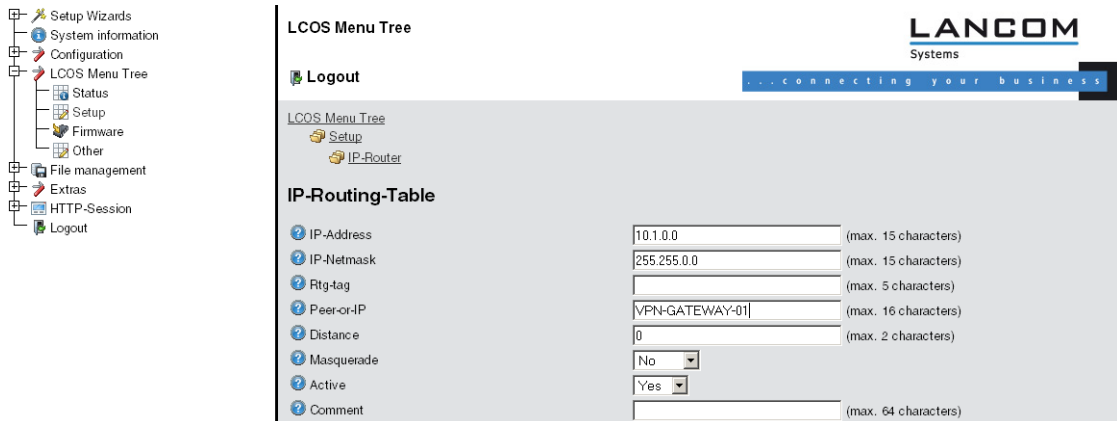

- For the "VPN gateway 2", the following entries are necessary so that the remote network sections can be reached.

IP address	Net mask	Router	IP masquerading
10.1.0.0	255.255.0.0	VPN gateway 1	No
10.2.0.0	255.255.0.0	VPN gateway 1	No
10.3.0.0	255.255.0.0	VPN gateway 1	No

For those subnetworks connected to your own LAN, define the router as the IP address for the appropriate LAN router.

IP address	Net mask	Router	IP masquerading
10.5.0.0	255.255.0.0	10.4.00.5	No

These entries enable VPN gateway 2 to forward packets arriving from the remote network to the correct sections of the local network.

- Under **Configuration / Firewall/QoS / Object table** make an entry for each part of the network that should be used as a source or destination for the VPN connection via "VPN GATEWAY 1" ("VPN-GW1-LOCAL" and "VPN-GW1-REMOTE"). Enter each subnet in the form "%A10.1.0.0 %M255.255.0.0".

LCOS Menu Tree

- Setup
  - IP-Router
  - Firewall

**Objects**

Name: VPN-GATEWAY-1 (max. 32 characters)

Description: %A10.1.0.0%M255.255.0.0 (max. 64 characters)

- Under **Configuration / Firewall/QoS / Rules table** define a new firewall rule named "VPN-GW1-OUT". Set the objects to "CPN-GW1-LOCAL" and "VPN-GW1-REMOTE", the protocol to "ANY" and the action to "ACCEPT". Activate the option "VPN rule" so that the IP networks described in this rule will be used in establishing VPN network relationships.

LANCOM Systems  
... connecting your business

LCOS Menu Tree

- Logout
- LCOS Menu Tree
  - Setup
    - IP-Router
    - Firewall

**Rules**

Name: VPN-GW1-OUT (max. 32 characters)

Prot.: ANY (max. 10 characters)

Source: VPN-GW1-LOCAL (max. 40 characters)

Destination: VPN-GW1-REMOTE (max. 40 characters)

Action: ACCEPT (max. 40 characters)

Linked: No

Prio: 0 (max. 4 characters)

Firewall-Rule: Yes

VPN-Rule: No

Stateful: Yes

Rtg-tag: 0 (max. 5 characters)

Comment: (max. 64 characters)

- ! As a rule, it is recommended that you keep the rules used for making network relationships separate from those firewall rules that affect the services used in communications, for example.

- Now for the incoming data transmissions, generate a firewall rule named "VPN-GW1-IN" with the same parameters as the rule just described. The only difference is that the source and the destination networks are swapped.

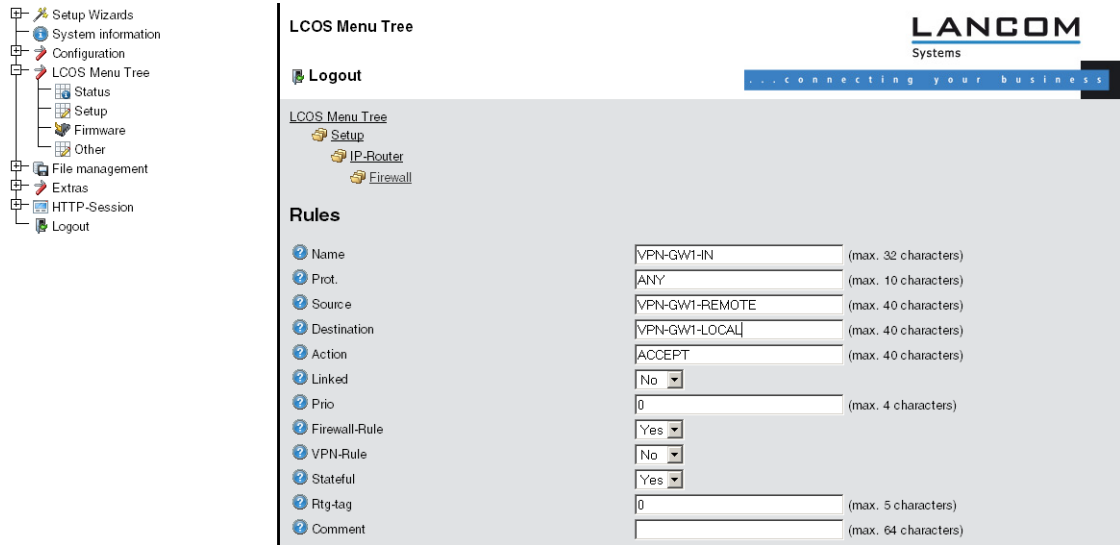

### 11.5.11 Establishing Security Associations collectively

Security Associations (SAs) are the basis for establishing a VPN tunnel between two networks. Parameters defined by a SA include:

- Source and destination network IP addresses
- Encryption, integrity check and authentication methods
- The key for the connection
- The key's lifetime

Security Associations are defined by automatically or manually generated VPN rules (also see in the reference manual).

The establishment of Security Associations is normally initiated by an IP packet which is to be sent from a source network to a destination network. With keep-alive connections, this is an ICMP packet which is sent to the remote site by an entry in the polling table.

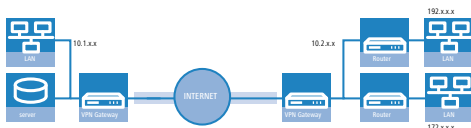

In complex network scenarios it is possible for multiple network relationships to be defined between two VPN gateways. If a single IP packet is transferred, then the SAs are established for this single packet and its corresponding network relationship only. To establish the other SAs, IP packets fitting to the other network relationships are needed.

It takes time to establish SAs based on data packets, and this can lead to the loss of packets as long as the SAs are not yet installed. This is often an undesirable side effect, particularly with keep-alive connections. Instead, **all** SAs relevant to the network relationships defined in the remote site should be established **immediately**. However, since the negotiation of SAs can make heavy demands on CPU performance—particularly in complex scenarios—the behavior can be defined with the parameter "Establish SAs collectively".

- Establish SAs collectively
  - Yes: All SAs defined in the device will be established.
  - No [default]: Only the SA which corresponds explicitly to a packet waiting for transfer is to be established.
  - Only with KeepAlive: All of the defined SAs will be established for remote stations in the VPN connection list with a hold time set to '9999' (Keep Alive).



WEBconfig: LCOS menu tree / Setup / VPN

 In most cases and particularly where automatically generated VPN rules are in use, the setting which establishes only explicitly corresponding SAs is perfectly sufficient.

The SAs currently in effect can be seen under /Status/VPN.

## 11.5.12 Diagnosis of VPN connections

If the VPN connections fail to work after the configuration of the parameters, the following diagnostic methods can be applied:

- The command **show vpn spd** on the Telnet console calls the "Security Policy Definitions".
- Use the command **show vpn sadb** to access information about the negotiated "Security Associations" (SAs).
- The command **trace + vpn** [status, packet] calls up the status and error messages for the current VPN negotiations.
  - The error message "No proposal chosen" indicates a fault in the configuration at the remote site.
  - The error message "No rule matched", on the other hand, indicates a fault in the configuration of the local gateway.

## 11.6 Working with digital certificates

The security of communications via VPN fulfils three core requirements:

- Confidentiality: The transmitted data cannot be read by unauthorized persons (via encryption).
- Integrity: The data cannot be changed during transmission (via authentication).
- Authenticity: The receiver can be certain that received data has genuinely been sent by the supposed sender (via authentication).

A number of encryption and authentication methods exist which provide satisfactory solutions for the first two aspects, confidentiality and integrity. The use of digital certificates aims to provide assurance about the authenticity of the communications partner.

### 11.6.1 Basics

Encryption methods can be divided into two categories: Symmetrical and the asymmetrical encryption.

#### Symmetrical encryption

This is a method known for thousands of years and is based on the fact that the sender and the recipient both have access to a message by knowing a secret shared key. This key can take on a wide variety of forms: The Romans used a stick of a certain diameter for encryption and decryption.

Today's digital communications rely in the main upon a password as the key. Using this password and an encryption algorithm, the data from the sender are changed. The recipient uses the same key and the fitting encryption algorithm so that the data become legible again. Other persons who do not know the key cannot read the data. A common symmetrical method of encryption is 3DES, for example.

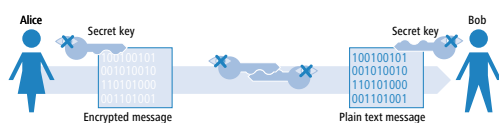

Example:

- Alice wants to send a confidential message to Bob. To do this, she encrypts the message with a secret key and a suitable method, e.g. 3DES. She sends the encrypted message to Bob informing him of the encryption method she used.
- Bob has the same key as Alice. Since he knows which encryption method was used, he can decrypt the message and transform it back into plain text.

Symmetrical encryption is simple and efficient but has two serious disadvantages:

- A different key is required for every secret communications relationship. If Alice and Bob are joined by Carol, three keys are necessary for secure data communications between all parties; with four participants, the number of keys required is six; with 12 participants, 66 keys are required and with 1000 participants, almost 500,000 keys are necessary! In a worldwide network with ever increasing demands for secure communications and higher numbers of participants, the serious nature of this problem is obvious.
- While this first disadvantage could be solved with technology, the second problem that is the core problem for symmetrical encryption: The secret key must be known at both ends of the communication and must not fall into the hands of unauthorized persons. Thus it is not possible for Alice simply to send the key to Bob per e-mail before the data connection has been secured sufficiently—which is the whole point of the encryption. She has to give the key to Bob in person, or at least make use of a communications method which is safe from eavesdroppers. This is a task which is almost impossible to handle in these times of worldwide dynamic communications.

## Asymmetric encryption

A totally new approach was developed in the 1970s; that of asymmetric encryption. This method no longer relies on a secret key that is known at both ends, but on a pair of keys instead:

- The first part of the key pair is used to **encrypt** the data that are to be sent to the key owner. This key, subsequently called the public key, can be made publicly available to anybody interested in communication.
- The second part of the key pair is the private key that is only used to **decrypt** the received message. This key is secret and may not fall into the hands of unauthorized persons.

The main difference to symmetrical methods: A publicly available key is used in this so-called "public key method". An example of an asymmetrical encryption method is RSA.

Let's take another look at the example with Alice and Bob:

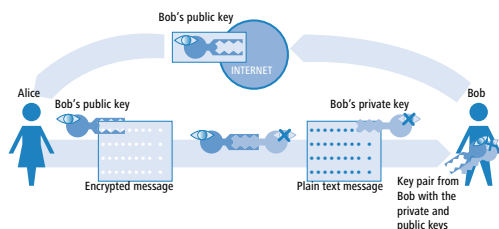

- For secure communications, Bob first of all generates a key pair with a private key and a public key that belong together. The method used for generating this key ensures that the private key cannot be backwardly computed with knowledge of the public key. Bob can now publicize the public key without worry. He can send it to Alice per e-mail or simply publish it on a web server.
- Alice now encrypts the message for Bob with his public key. This now illegible message can only be decrypted by using Bob's private key. Even if the data are intercepted on the way from Alice to Bob, no-one but Bob can regenerate the plain text message.

The asymmetrical encryption offers the following advantages over symmetrical variants:

- A key pair is not required for every communications relationship, but for each participant only. Even with 1000 participants, each user needs only his/her personal key pair, of which only the public key is publicly available. Instead of 500,000 secret keys, the public key method requires just 1000 key pairs.
- The risky transmission of a secret key to the communications partner is simply not necessary as knowledge is only required of the public key on the other side of the communications relationship. This is the solution to a significant problem in the dynamic encryption of data between multiple participants.

## Combination of symmetrical and asymmetrical encryption

Asymmetrical encryption methods have quickly become established due to the security they offer. However, security has its price: Asymmetrical encryption methods are slow. The mathematics involved in the encryption and decryption of messages is far more complex than with symmetrical encryption methods and thus require more computing time—a critical factor when transmitting larger quantities of data.

The advantages of symmetrical and asymmetrical encryption can be used in suitable combinations of these methods. In this way, the higher security of the asymmetrical encryption is used to protect the transmission of the secret key. The actual data for transmission are then encrypted with the faster symmetrical method.

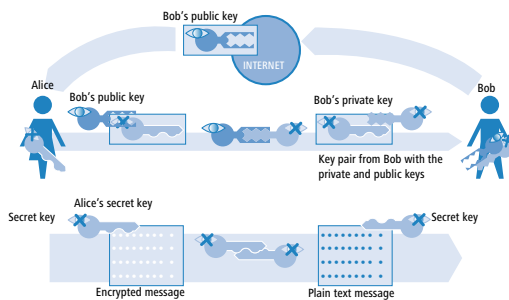

- First of all, Bob generates a key pair and publicizes the public key.
- Alice uses the public key to **encrypt** a secret symmetrical key and sends this to Bob. For each transmission, this secret key is newly defined according to a random procedure.
- Bob is the only one who can **decrypt** this secret key by using his private key.
- Alice and Bob then use this secret key to **encrypt** and **decrypt** the clearly much larger volume of the payload data.

## Public key infrastructure

The combination of symmetrical and asymmetrical encryption methods enable initially unsecured connections to be used to establish secure data communications. Until now, the aspect of authenticity has been ignored. How should Alice know that the public key really does come from Bob? The use of public keys thus depends directly on the trust in the authenticity of the communications partner.

To secure this trust, a confirmation of the key pairs for use with asymmetrical encryption can be issued by publicly recognized and trustworthy authorities. In Germany, for example, the highest authority for the confirmation of digital keys is the Regulatory Authority for Telecommunications and Post (RegTP). The RegTP in turn issues accreditations to suitable service providers who are viewed as equally trustworthy.

 The RegTP web site ([www.regtp.de](http://www.regtp.de)) features up-to-date lists of accredited certification service providers and notification of revoked accreditations. Accredited service providers include numerous tax advisers and legal associations.

The task of this organization is to attribute a public key to just one person or organization. This attribution is recorded and officially publicized in a certificate. Consequently these providers are known as Certification Authorities, or CAs for short. The uppermost certification authority is known as the Root CA.

Bob can now approach a CA to have his public key certified as belonging to him. He submits his public key to the CA who then confirm that the key belongs to Bob.

The CA issues a certificate which lists the public key and further information about Bob, such as his identity, among other things.

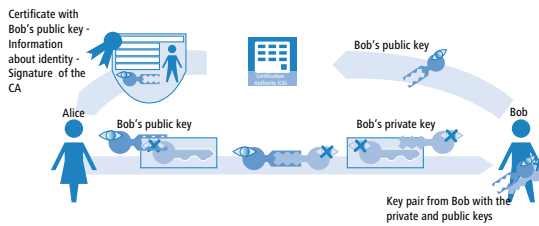

The certificate carries the signature of the CA to show that the confirmation itself is genuine. The certificate takes up just a small amount of data and is suitable for exchange with an asymmetric method. With a signature, however, the asymmetric method is used in the opposite direction:

- The CA, too, has a key pair consisting of private and public keys. Since this is a trustworthy authority, their key pair can be considered as reliable.
- The CA calculates a hash value for the certificate, encrypts this and uses it in the signature in Bob's certificate. This acts to confirm the attribution of Bob's public key to his identity.

This procedure behaves in the opposite manner to the normal asymmetrical encryption. In this case, the encryption does not fulfil the task of protecting the data from unauthorized persons, but confirms the signature of the CA instead.

- Any data communications participant anywhere in the world with the public key from the CA is now in a position to check the signed certificate.

Only the CA is in a position to use their private key to generate signatures that can be decrypted again by using the CA's public key. This signature guarantees that the certificate is genuinely sourced from the issuing CA.

## 11.6.2 Advantages of certificates

In some cases the use of certificates for securing VPN connections can be an alternative to the otherwise widespread preshared key (PSK) method:

- Increase security of VPN client connections (with IKE Main Mode)

Main Mode cannot be used when using PSK connections between peers that use dynamic IP addresses. In these cases, the aggressive mode must be used with its lower degree of security. Using certificates allows peers with dynamic IP addresses, such as dial-in computers with LANCOM Advanced VPN Client, to use the Main Mode and thus to increase the level of security.

- Higher security of the used keys and passwords

Preshared keys are just as susceptible as other passwords, too. The way that users treat these passwords is a major factor in the securing of connections. With a certificate-based VPN establishment, the keys in the certificates are automatically generated with the desired key length. What's more, the random keys generated by computers offer more security from attack than the preshared keys of the same key length thought up by people.

- Possibility of authenticating remote sites

When connecting with certificates other remote stations must authenticate themselves. Further information can be contained in the certificates, which can be used for testing remote sites. The time limit of the certificates provide an additional protection, e.g. for users, who are only supposed to have access for a limited period of time.

- Providing tokens and smartcards

When saving certificates on external data media the integration of "Strong Security" environments, the readout of passwords from computers of networks is inhibited.

The advantages of certificates have to be considered in relation to the considerable increase in effort of introducing and maintaining a public key infrastructure (PKI).

## 11.6.3 Structure of certificates

### Contents

A certificate contains a variety of information which is important for it to fulfil its purpose. Some information is obligatory, some is optional. A certificate can also be stored in a variety of different formats. An X.509-standard certificate contains the following information, for example:

- Version: This is the relevant version of the X.509 standard. The current (06.2005) version is 'v3'.
- Serial number: This is a unique number that identifies the certificate.
- Signature algorithm: This identifies the algorithm that the issuer used to sign the certificate. The digital signature of the issuer is also to be found here.
- Validity: Certificates are valid for a limited period of time. This entry indicates the duration of the certificate's validity.
- Issuer: This identifies the issuer, for example by name, e-mail address, nationality, etc.
- Subject: This identifies the certificate's owner, for example by name, institution, e-mail address, nationality, city, etc.
- Subject public key: Information indicating the method used to generate the public key used by the certificate's owner. The owner's public key is also to be found under this item.

### Target application

When the certificates are generated, the possible uses of the certificate usually have to be selected. Some certificates are intentionally designed for transfer with web browsers or e-mails only, and others are more generally applicable to any use.

---

 When you generate certificates, make sure that you enter its intended purpose.

### Formats

The ITU standard X.509 is a wide spread format for certificates. When displayed as text, this type of certificate looks like the following:

Certificate:

Data:

Version: 3 (0x2)

Serial Number: 1 (0x1)

Signature algorithm: md5WithRSAEncryption

Issuer: C=XY, ST=Austria, L=Graz, O=TrustMe Ltd, OU=Certificate Authority, CN=CA/Email=ca@trustme.dom

Validity

Not Before: Oct 29 17:39:10 2000 GMT

Not After : Oct 29 17:39:10 2001 GMT

Subject: C=DE, ST=Austria, L=Vienna, O=Home, OU=Web Lab, CN=anywhere.com/Email=xyz@anywhere.com

Subject Public Key Info:

Public Key Algorithm: rsaEncryption

RSA Public Key: (1024 bit)

Modulus (1024 bit):

00:c4:40:4c:6e:14:1b:61:36:84:24:b2:61:c0:b5:

```

d7:e4:7a:a5:4b:94:ef:d9:5e:43:7f:c1:64:80:fd:
9f:50:41:6b:70:73:80:48:90:f3:58:bf:f0:4c:b9:
90:32:81:59:18:16:3f:19:f4:5f:11:68:36:85:f6:
1c:a9:af:fa:a9:a8:7b:44:85:79:b5:f1:20:d3:25:
7d:1c:de:68:15:0c:b6:bc:59:46:0a:d8:99:4e:07:
50:0a:5d:83:61:d4:db:c9:7d:c3:2e:eb:0a:8f:62:
8f:7e:00:e1:37:67:3f:36:d5:04:38:44:44:77:e9:
f0:b4:95:f5:f9:34:9f:f8:43
Exponent: 65537 (0x10001)
X509v3 extensions:
X509v3 Subject Alternative Name:
email:xyz@anywhere.com
Netscape Comment:
mod_ssl generated test server certificate
Netscape Cert Type:
SSL Server
Signature Algorithm: md5WithRSAEncryption
12:ed:f7:b3:5e:a0:93:3f:a0:1d:60:cb:47:19:7d:15:59:9b:
3b:2c:a8:a3:6a:03:43:d0:85:d3:86:86:2f:e3:aa:79:39:e7:
82:20:ed:f4:11:85:a3:41:5e:5c:8d:36:a2:71:b6:6a:08:f9:
cc:1e:da:c4:78:05:75:8f:9b:10:f0:15:f0:9e:67:a0:4e:a1:
4d:3f:16:4c:9b:19:56:6a:f2:af:89:54:52:4a:06:34:42:0d:
d5:40:25:6b:b0:c0:a2:03:18:cd:d1:07:20:b6:e5:c5:1e:21:
44:e7:c5:09:d2:d5:94:9d:6c:13:07:2f:3b:7c:4c:64:90:bf:
ff:8e

```

## File types

There are various file types for digital certificates and private keys depending on the issuer. The following types are common:

- \*.pfx and \*.p12: PKCS#12 files
- \*.pem, \*.cer and \*.crt: BASE-64-coded certificates
- \*.cer, \*.crt and \*.der: DER coded certificates
- \*.key: BASE64 or DER coded keys
- \*.pvk: Microsoft-specific key format

Apart from the straightforward certificates, there is another file type that is of significance in the world of certificate-secured VPN connections: The PCK#12 files which can contain multiple components such as a certificate and a private key. To process the PKCS#12 file, a password has to be entered which was set when the certificate was exported.



BASE64-coded certificates have a header that typically features the following lines: ----- BEGIN CERTIFICATE -----

## Validity

A further option is to refer to a certificate revocation list (CRL). CRLs list certificates that have lost their validity, for example if an employee has left the company and his certificate has been withdrawn. This information allows those who are checking certificates to refer to the appropriate CRL.

### 11.6.4 Security

Certain security aspects have to be observed even when dealing with certificates:

- Only ever transfer private keys via secure connections, e.g. with HTTPS.
- Passwords for keys or PKCS#12 files should be passphrases that are long enough and secure.

### 11.6.5 Certificates for establishing VPN connections

Along with basic information about certificates, this section now considers their concrete application in establishing VPN connections. For connection establishment with the support of certificates, certain information must be available at both ends of the connection (e.g. when connecting a branch office to the network at headquarters via LANCOM routers):

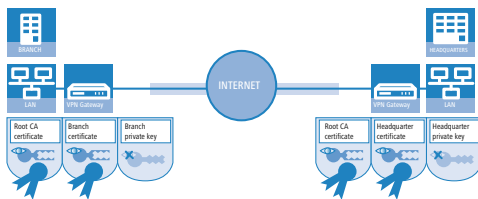

- The branch office has the following components:
  - The Root CA's certificate with the CA's public key
  - A certificate for its own device with its own public key and the confirmation of identity. The hash value of this certificate is signed with the CA's private key.
  - Its own private key
- The headquarters has the following components:
  - The Root CA's certificate with the CA's public key
  - A certificate for its own device with its own public key and the confirmation of identity. The hash value for this certificate is signed with the CA's private key.
  - Its own private key

Put simply, the following procedures are carried out during the VPN connection exchange in Main Mode (symmetrical in both directions):

1. In an initial exchange of packets the peers negotiate, for example, the methods of encryption and authentication that are to be used. At this phase, both ends are not fully certain about who they are negotiating with, although this is not yet critical.
2. At the next stage, common key material is negotiated for the continued communications, including among other things symmetrical keys and asymmetrical key pairs. At this phase, too, the two ends are not yet fully certain about who the keys are being negotiated with.
3. In the next stage, the certificate is used in a check to ensure that the peer involved in negotiating the key material really is the intended communication partner:
  - The branch office uses the current negotiation's key material to calculate a checksum (hash value) that can only be calculated by the two peers involved (branch office and headquarters) and only so long as the connection exists.
  - The branch office encrypts the hash with its own private key, generating a signature with it.
  - The branch office then transmits this signature together with its own certificate to the peer at headquarters.

- The headquarters then checks the signature of the certificate received from the branch office. This can be done with the help of the public key at the Root CA, which is identical for both peers. If the signature in the branch office's certificate (generated with the CA's private key) can be decrypted with the CA's public key, then the signature is valid and the certificate is trustworthy.
- In the next stage, the headquarters checks the signature of the encrypted hash. The branch office's public key in the corresponding certificate was found to be valid at the previous stage. The headquarters can thus check if the signed hash can be decrypted with the branch office's public key. The headquarters can calculate the same hash as the branch office using the key material for the current connection. If this check is successful then the peer "branch office" can be considered as authentic.

### 11.6.6 Certificates from certificate service providers

Certificates on offer from public certifiers are available in various security classes. The higher security classes require more effort on behalf of the applicants to demonstrate the authenticity of their identity to the CA. The Trustcenter AG in Hamburg, for example, uses the following classes:

- Class 0: These certificates are issued without an identity check and serve only for customer tests.
- Class 1: For this class, the existence of an e-mail address is the only check. These certificates are useful for private users wishing to sign their e-mails, for example.
- Class 2: This level, too, does not involve any personal proof of identity. The submission of an application along with, for example, a certificate of company registration is sufficient. This level is suitable for communications between companies that already know each other.
- Class 3: This level involves a personal check of the person or company. The information in the issued certificates is compared with a passport or a notarized copy of the certificate of company registration. This level is suitable for advanced applications such as e-business or online banking.

In your dealings with public certificate service providers, be sure to check in detail the security class or the proof of identity. This is the only way to be sure that the certificates really do meet with your security requirements.

### 11.6.7 Establishing a proprietary CA

Referring to public CAs for secure enterprise communications can only be recommended under certain conditions.

- There is considerable effort involved in the issue of new certificates and this can be slow.
- The keys in use are transferred via connections which are inadequately secured.
- Communication is based upon the trust in the CA.

An alternative for company communications is to establish a proprietary CA. Suitable packages are the Microsoft CA on a Microsoft Windows 2003 server or, as an open source version, OpenSSL. A proprietary CA empowers you to issue and manage all of the necessary certificates for secure data exchange with complete independence from any external parties.

Companies are recommended to use a proprietary CA rather than public certifiers. There are, however, several important issues to be considered when planning a CA. For example, even as early as during the installation of a Windows CA, the validity period for the Root CAs has to be defined and cannot be altered subsequently. Other aspects of planning include:

- The certificate policy or the level of security that is to be achieved with certificates
- The available name space
- Key lengths
- The duration of certificate validity
- Managing blocking lists

Precise planning is strongly recommended since corrections at a later date often imply considerable amounts of effort.

### 11.6.8 Requesting a certificate with Stand-alone Windows CA

 For operations with a LANCOM, a combination of PKCS#12 file with root certificate, a proprietary device certificate and the device's public key offer the best services.



1. Using your browser, access the start page of the Microsoft Certificate Services.
2. For the certificate type, select 'Advance Certificate Request'.
3. The next step is to selection the option 'Generate and submit a certificate request '.



If, and only if, the root certificate is already available as a file, select the option 'BASE64'.

4. In the following step the information for identification is entered.

**Microsoft Certificate Services - Microsoft Internet Explorer**

Address: <http://10.1.207.135/certsrv/certreqna.asp>

**Microsoft Certificate Services -- LCS-CA-TEST** Home

**Advanced Certificate Request**

**Identifying Information For Offline Template:**

Name:

E-Mail:

Company:

Department:

City:

State:

Country/Region:

**Certificate Template:**

Object ID:

**Key Options:**

Create new key set  Use existing key set

CSP:

Key Usage:  Signature

Key Size:  Min: 384 Max: 10384 (common key sizes: 612 1024 2038 3098 8192 10384)

Automatic key container name  User specified key container name

Mark keys as exportable

Export keys to file

**Additional Options:**

Request Format:  CMC  PKCS10

Hash Algorithm:  Only used to sign request.

Save request to a file

Attributes:

Friendly Name:

1. In the same dialog, select the certificate template as 'Other...' and then delete the value in 'Object ID'.

The screenshot shows the Microsoft Certificate Services web interface in Internet Explorer. The page title is "Microsoft Certificate Services - LCS-CA-TEST". The main heading is "Advanced Certificate Request".

**Identifying Information For Offline Template:**

Name: Joe Public  
E-Mail: joe\_public@firm.com  
Company: FIRM  
Department: IT-Solutions  
City: New York  
State: NY  
Country/Region: US

**Certificate Template:**

Object ID: [Empty field]

**Key Options:**

Create new key set    Use existing key set  
CSP: Microsoft Enhanced Cryptographic Provider v1.0  
Key Usage:  Signature  
Key Size: 2048 (Min: 304, Max: 16384, Common key sizes: 512 1024 2048 4096 8192 16384)  
 Automatic key container name    User specified key container name  
 Mark keys as exportable  
 Export keys to file

**Additional Options:**

Request Format:  CMC    PKCS10  
Hash Algorithm: SHA-1  
*Only used to sign request.*  
 Save request to a file  
Attributes: [Empty field]  
Friendly Name: [Empty field]

[Submit >]

1. Mark 'Create new key set'. The public and private keys for the current user will now automatically be generated by the CA.

The screenshot shows a web browser window displaying the Microsoft Certificate Services interface. The page title is "Microsoft Certificate Services - LCS-CA-TEST". The main heading is "Advanced Certificate Request".

**Identifying Information For Offline Template:**

Name: Joe Public  
 E-Mail: joe\_public@firm.com  
 Company: FIRM  
 Department: IT-Solutions  
 City: New York  
 State: NY  
 Country/Region: US

**Certificate Template:**

Object ID: [Other..]

**Key Options:**

Create new key set    Use existing key set

CSP: Microsoft Enhanced Cryptographic Provider v1.0

Key Usage:  Signature

Key Size: 2048 (Min: 384, Max: 16384, Common key sizes: 512 1024 2048 4096 8192 16384)

Automatic key container name    User specified key container name

Mark keys as exportable

Export keys to file

**Additional Options:**

Request Format:  CMC    PKCS10

Hash Algorithm: SHA-1

Save request to a file

Attributes: [ ]

Friendly Name: [ ]

[Submit >]

1. Select the key size according to certificate policy and activate the option to mark keys as exportable.

! The key is not exported at this point and so a file name does not have to be specified. An export would create a Microsoft-specific \*.pvk file, a format which is unsuitable for use with a LANCOM.

2. Finally, select the hash algorithm 'SHA-1' and send your certificate request with a click on **Submit**.

**Microsoft Certificate Services - Microsoft Internet Explorer**

Address: <http://10.1.207.135/certsrv/certrqma.asp>

**Microsoft Certificate Services - LCS-CA-TEST** Home

**Advanced Certificate Request**

**Identifying Information For Offline Template:**

Name:   
 E-Mail:   
 Company:   
 Department:   
 City:   
 State:   
 Country/Region:

**Certificate Template:**

Object ID:

**Key Options:**

Create new key set  Use existing key set  
 CSP:   
 Key Usage:  Signature  
 Key Size:  Min: 304 (common key sizes: 512 1024 2048 4096 8192 16384) Max: 16384  
 Automatic key container name  User specified key container name  
 Mark keys as exportable  
 Export keys to file

**Additional Options:**

Request Format:  CMC  PKCS10  
 Hash Algorithm:   
Only used to sign request.  
 Save request to a file  
 Attributes:   
 Friendly Name:

You can check on the status of your certificate request at any time via the Windows CA start page. Certificate requests can only be viewed from the same computer used to submit the request.

1. The certificate can be installed on your computer once the CA administrator has checked the request and created the certificate.

Certificates can only be installed on the same computer that was used for the request.

### 11.6.9 Export the certificate to a PKCS#12 file

The installation stores the certificate in your operating system but it is not yet available as a separate file. You will need this for installation to the LANCOM, though. For access to a certificate in file form, it has to be exported first.

## Export via the Windows console root

1. Open the Management console with the command `mmc` at the command line and select the menu item **File / Add/Remove Snap-In**.

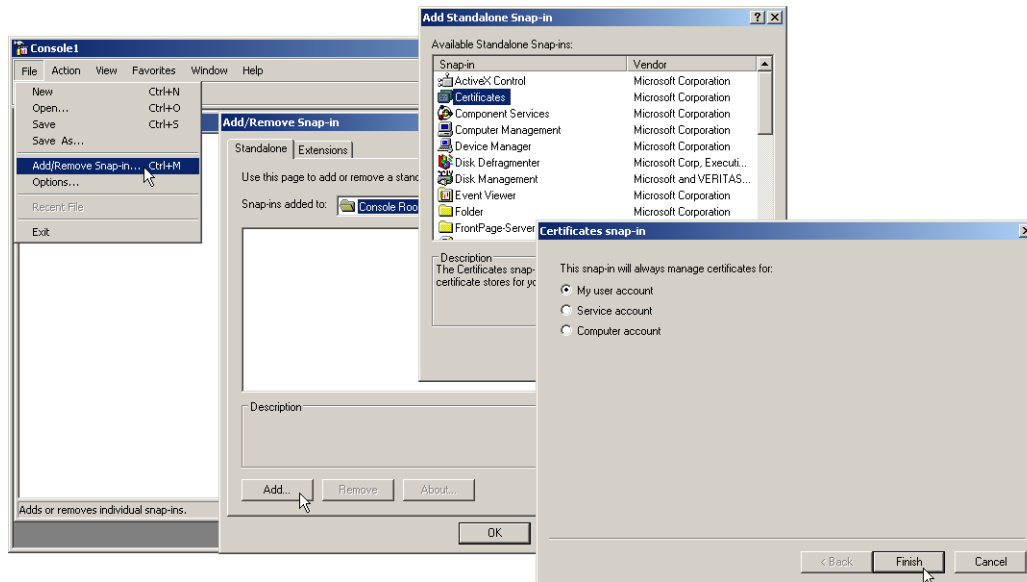

1. Click on **Add...** and select 'Certificates'. Confirm with **Add**, then mark 'My user account' and click on **Finish**.
2. To export the desired certificate to a file, go to the Management console and click in the group **Certificates - current user / My certificates/ Certificates** with the right mouse key and, from the context menu, select **All tasks / Export**.

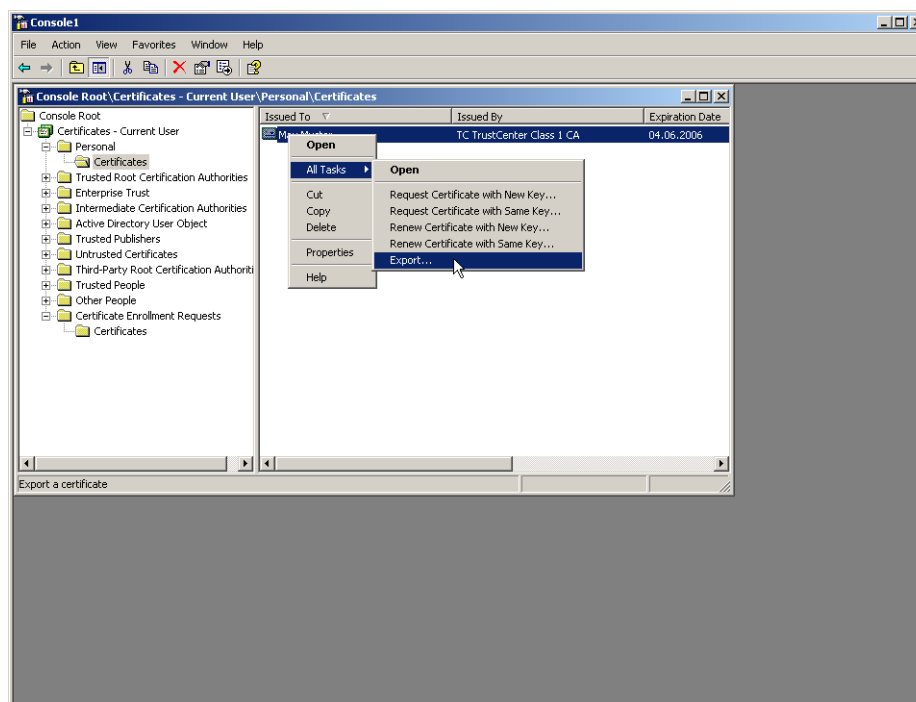

1. In the Certificate Export Wizard, activate the option to export the private key. You can optionally delete the private key from the system after exporting.

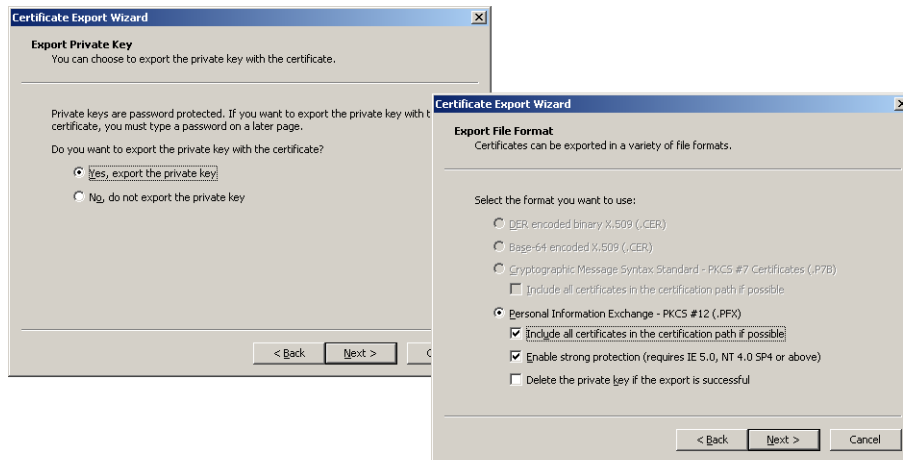

! The option 'Include all certificates in the certification path' must be activated so that the root certificate is also exported to the PKCS#12 file.

1. You will be requested to enter a password to protect the private key. Ensure that you choose a secure password of sufficient length (passphrase). You will need this password later to install the certificated in the LANCOM.

! The term password is synonymous with other terms used in the different environments, e.g. "PIN".

## Export via the Control Panel

As an alternative, you can open certificates on your system via the Control Panel.

1. To do this, click on **Start / Control Panel / Internet Options**, the 'Contents' tab and the button **Certificates**.
2. Choose the required certificate and click on **Export**.

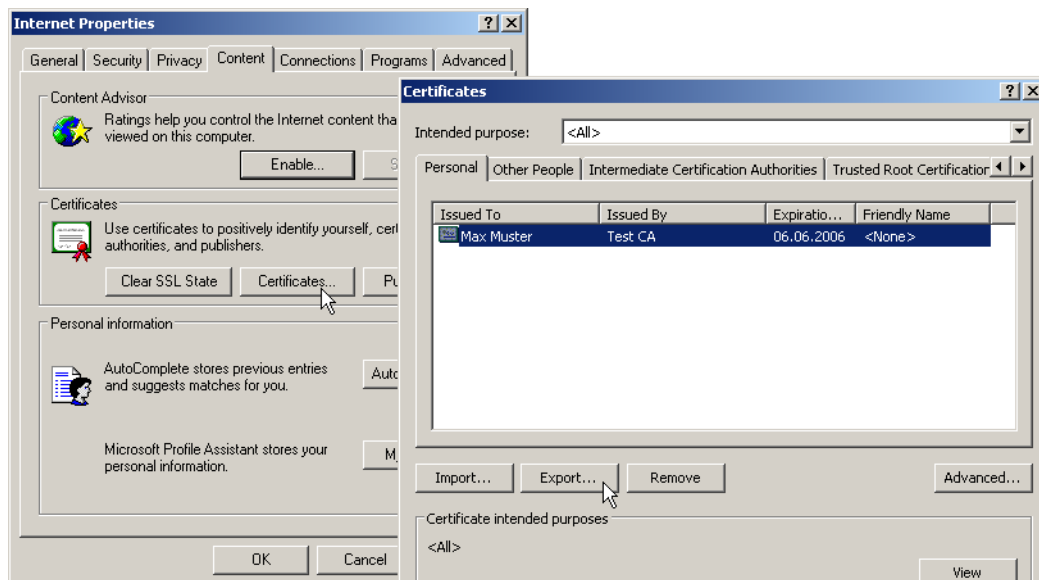

! The actions required in the Certificate Export Wizard that follows are identical to those described under .

## 11.6.10 Create certificates with OpenSSL

OpenSSL is a further possibility for creating proprietary certificates and to test certified connections. OpenSSL is an OpenSource project available for Linux and Windows at no cost; as a command-line tool, however, it does not offer the user-friendliness of other CA variants.

---

 The configuration file `openssl.cnf` must be adapted to your specific needs. Further information is available in the OpenSSL documentation.

### Installing OpenSSL

1. Download the current version of OpenSSL from <http://www.slproweb.com/products/Win32OpenSSL.html>.
2. Install the package and, in the directory `./bin/PEM/demoCA` create the following subdirectories:
  - `/certs`
  - `/newcerts`
  - `/crl.`
3. In the file `openssl.cnf`, change the path in the `[CA_default]` group to: `dir= ./PEM/demoCA`
4. OpenSSL is started with a double-click on `openssl.exe` in the `./bin` directory.

### Issue a certificate for Root CA

1. Create a key for the CA with the command:
  - `genrsa -des3 -out ca.key 2048`

---

 Remember the password that you enter after the request for the CA key as you will need it again later!

This command creates the file 'ca.key' in the current directory.

2. Create a certificate request for the CA with the command:
  - `req -key ca.key -new -subj /CN="Test_CA" -out ca.req`

---

 You will be requested to enter the password for the CA key here.

This command creates the file 'ca.req' in the current directory.

3. Create a certificate from the certificate request with the command:
  - `x509 -req -in ca.req -signkey ca.key -days 365 -out ca.crt`

---

 Here, too, you will be requested to enter the password for the CA key.

This command signs the certificate request 'ca.req' with the key 'ca.key' and then issues the certificate 'ca.crt'.

### Issue certificates for users or devices

1. Create a key for the device or user with the command:
  - `genrsa -out device.key 2048`

This command creates the file 'device.key' in the current directory.
2. Create a certificate request for the device or user with the command:
  - `req -key device.key -new -subj /CN=DEVICE -out device.req`

This command creates the file 'device.req' in the current directory.

⚠ Apart from this instruction further changes are necessary in the file "openssl.cnf" for the definition of a Extension.

3. Create a certificate from the certificate request with the command:

- `x509 -extfile openssl.cnf -req -in device.req -CAkey ca.key -CA ca.crt -CAcreateserial -days 90 -out device.crt`

This command signs the certificate request 'device.req' with the key 'ca.key' and then issues the certificate 'device.crt'. The configuration file openssl.cnf is also involved in the procedure.

4. Export the certificate for the device or user with the command:

- `pkcs12 -export -inkey device.key -in device.crt -certfile ca.crt -out device.p12`

This command combines and saves the key 'device.key', the certificate 'device.crt' and the root certificate 'ca.crt' in the file 'device.p12'. This PKCS#12 file can be uploaded directly to the required device.

### 11.6.11 Upload certificates to the LANCOM

The following components must be available in a LANCOM for the establishment of VPN connections that are secured by certificate.

- The Root CA's certificate with the CA's public key
- A certificate for its own device with its own public key and the confirmation of identity. The hash value for this certificate is signed with the CA's private key.
- Its own private key

If you have followed the instructions for issuing certificates with a Windows CA and their export, then this information will now be available in the form of a combined PKCS#12 file. Alternatively you have used a different method and the individual components are available as separate files.

⚠ The certificate file can at this time only be uploaded to the devices with WEBconfig. Make sure that you use an HTTPS connection as the passphrase for the PKCS#12 file is transmitted unencrypted

1. Use WEBconfig to log on to the required device; you will need administrator rights.
2. Select the entry for **Upload Certificate or File**.

The screenshot shows the LANCOM WEBconfig interface. On the left is a navigation tree with items like 'Setup Wizards', 'System information', 'Configuration', 'LCOS Menu Tree', 'File management', 'Extras', 'HTTP-Session', and 'Logout'. The main content area is titled 'Upload Certificate or File' and features the LANCOM logo and tagline '... connecting your business'. Below the title, there are instructions: 'Select which file you want to upload, and its name/location, then click on 'Start Upload'. In case of PKCS12 files, a passphrase may be necessary.' There are three input fields: 'File Type:' with a dropdown menu set to 'SSL - Certificate (\*.pem, \*.crt, \*.cer [BASE64])', 'File Name/Location:' with a text box and a 'Durchsuchen...' button, and 'Passphrase (if required):' with a masked text box. A 'Start Upload' button is located at the bottom of the form.

1. Select the components that you wish to upload to the device:

- Root certificate
- Device certificate



- Private key for the device
- PKC#12 file with a combination of root certificate, device certificate and private key

! The relevant password must be entered depending on the type of file to be uploaded.

The uploaded files can then be viewed in a list under **LCOS menu tree / Status / File system / Content**.



The screenshot shows the LANCOM Systems interface. On the left is a tree view of the LCOS Menu Tree. On the right, the 'Contents' section displays a table of files:

Name	Size
oemdata	23348
testtime	122
tempminmax	60
vpn_rootcert	1432
vpn_devcert	1484

! A combined PKCS#12 file is divided up into the necessary components upon upload.

## 11.6.12 Storing and uploading certificates

Various certificates can be used in a LANCOM for the encryption of certain services. These certificates can be uploaded to the devices by using LANconfig. Furthermore, the certificates in a device can also be read by LANconfig and stored to a file.

1. Select the device which you want to upload a certificate into, or from which you want to save a copy.
2. Click on the device with the right mouse key and from the context menu select **Configuration management / Save certificate as file** or **Upload certificate from file**.

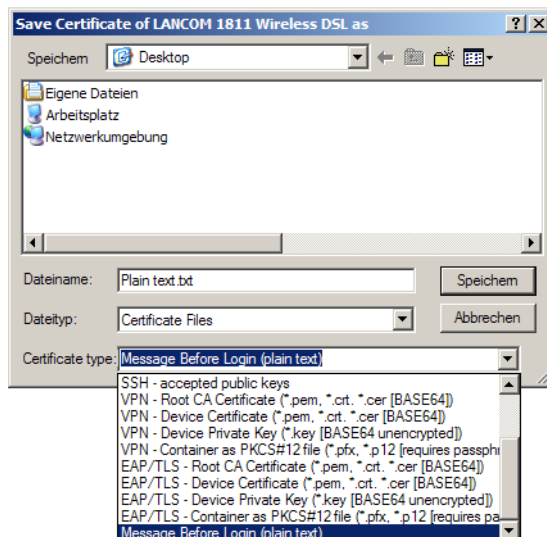

1. Select the storage location and the type of certificate to be saved or uploaded and confirm your selections with **Save/Open**.

! By selecting several devices, a certificate file can be uploaded to several devices at once. It is however not possible to simultaneously save the certificates from multiple devices. Depending on the type of certificate file, a passphrase may be necessary for uploading.

## Addition(s) to LCOS 7.80

### Enhanced certificate support

In order to support multiple certificate hierarchies, LCOS as of version 7.80 allows up to nine PKCS#12 files to be uploaded to the device. Also, further files with individual additional CA certificates can be uploaded, which enclose the certificates either individually or as PKCS#12 containers. All certificate hierarchies can be managed manually or with SCEP, and they can use CRLs.

LANconfig: Device / Configuration management / Upload certificate from file

WEBconfig: File management / Upload certificate or file

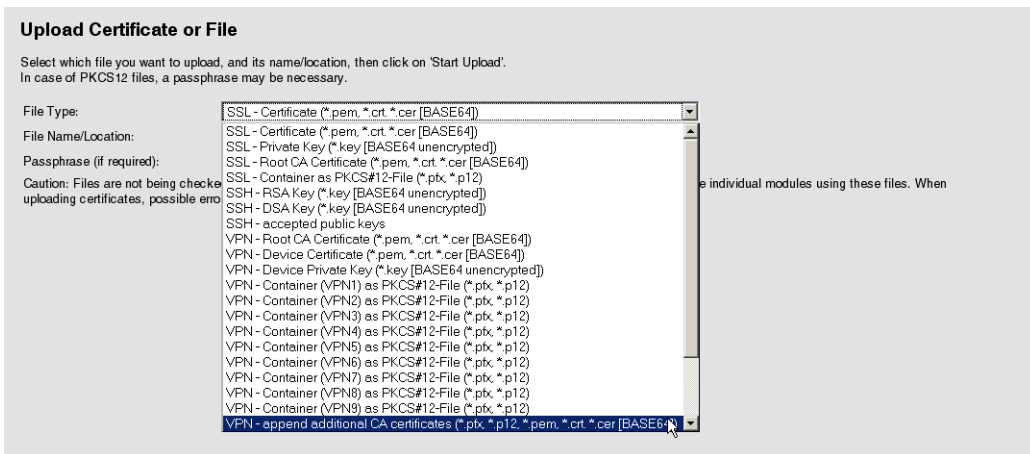
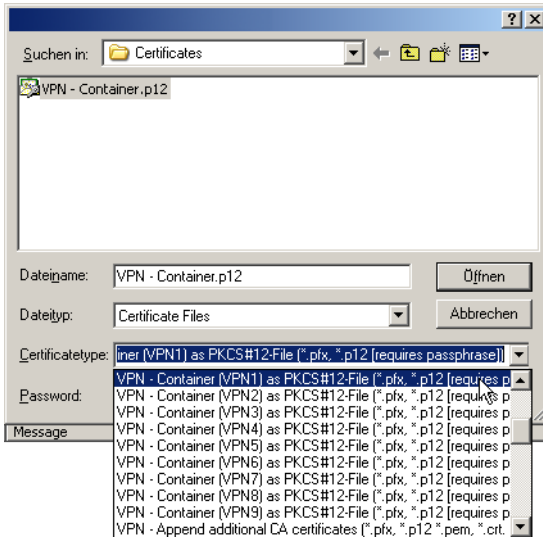

The certificates in the device can be viewed in the status area:

WEBconfig: Status / Status / Certificates / Device certificates

The internal file system for the device classifies the device certificates as applications "VPN-1" to "VPN-9".

To use the certificate, either the certificate subject or this abbreviation can be used as "local identity" in the IKE keys of type ASN.1-Distinguished Name.

**!** Using this abbreviation to reference the certificates allows subjects containing special characters to be used, such as German umlauts. This is not usually possible when working with the command-line interface configuration.

The abbreviation is entered as "Application" when configuring the certificates for the SCEP client.

### 11.6.13 Set up VPN connections to support certificates

! VPN connections, which support certificates, can only be set up, if the LANCOM has the correct time. If the device does not have the actual correct time, the validity of the certificates can not be evaluated. The certificates will be rejected and no connection will be set up.

Several areas of the configuration have to be changed to set up VPN connections to support certificates.

- IKE proposals
- IKE proposal lists
- IKE key
- VPN parameters
- Connection parameters

! Some of the values may already be available in your device depending on its firmware version. In this case you just have to check that the values are set correctly.

! If you are reconfiguring a remote device for certificate support with the method described below, and that device can only be reached via a VPN tunnel, then it is imperative that you reconfigure the remote device first before adjusting the connection in the local device. Changing the local configuration first would make the remote device unattainable!

1. The proposals lists are to be supplemented with two new proposals with the exact description of 'RSA-AES-MD5' and 'RSA-AES-SHA', both of which use 'AES-CBC' for encryption and 'RSA signature' as the authentication mode, and which differ only in their hash method (MD5 and SHA1). I

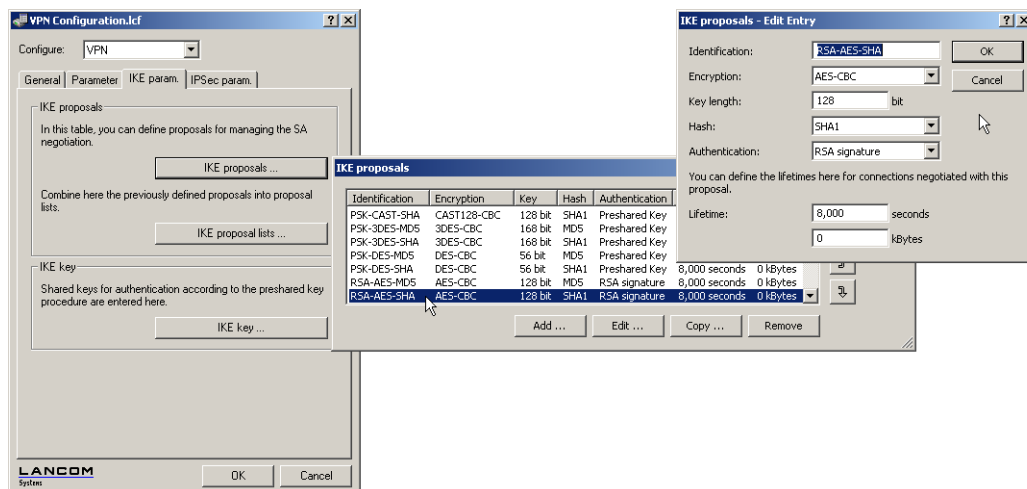

LANconfig: VPN / IKE param. / IKE proposals

WEBconfig: LCOS menu tree / Setup / VPN E Proposals / IKE

1. A new list will be required in the proposals lists with the exact name 'IKE\_RSA\_SIG' which contains the two new proposals 'RSA-AES-MD5' and 'RSA-AES-SHA'.

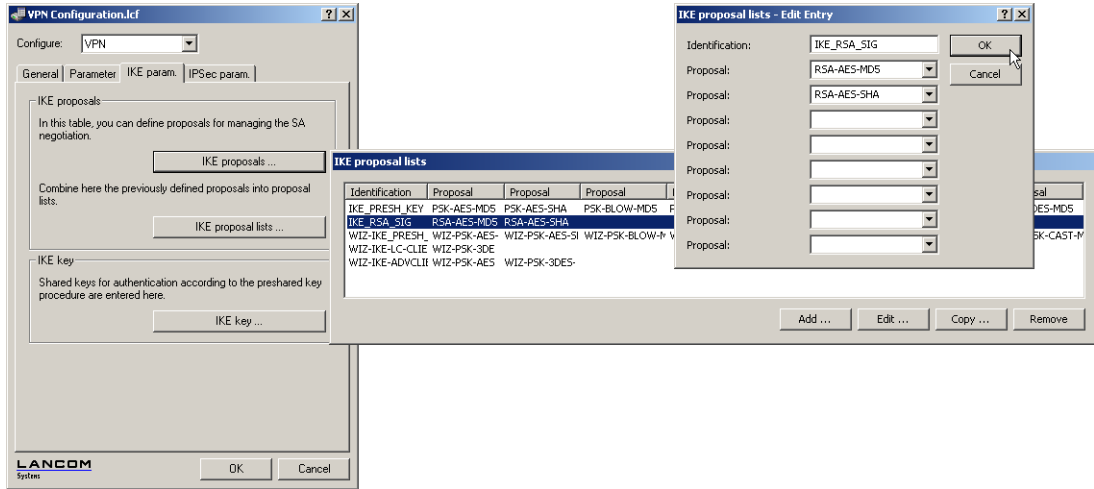

LANconfig: VPN / IKE param. / IKE proposal lists

WEBconfig: LCOS menu tree / Setup / VPN E Proposals / IKE proposal lists

1. In the list of IKE keys, all certificate connections must be set up with the corresponding identities.

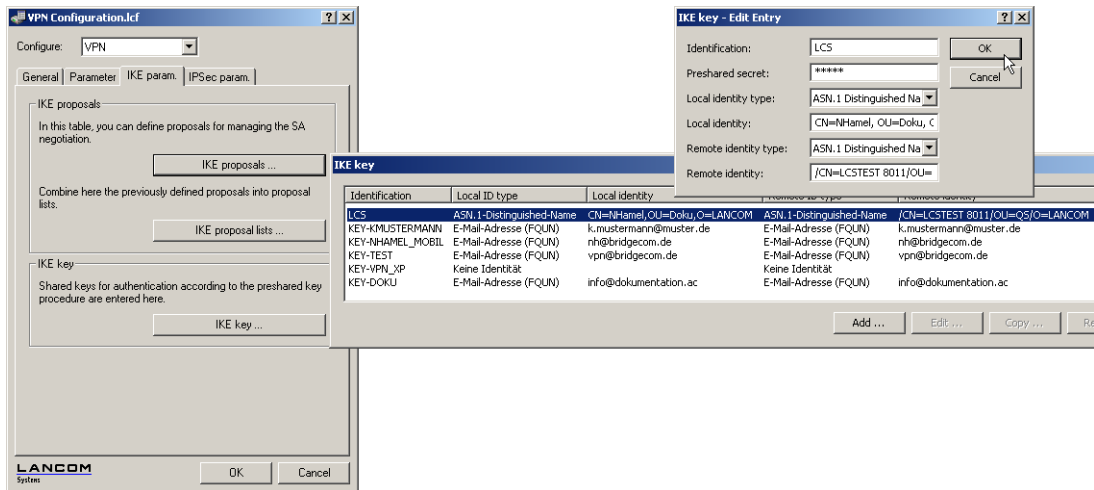

LANconfig: VPN / IKE-Param. / IKE key

WEBconfig: LCOS menu tree / Setup / VPN / Proposals / IKE-Keys

- Once it is no longer required, the preshared key can be deleted.
  - The type of the identities is reset to ASN.1 Distinguished Names (local and remote).
  - The identities are entered exactly as they stand in the certificates. The individual values such as 'CN', 'O' or 'OU' can be separated by commas or slashes.

All of the values entered in the certificates must be listed in the same order. If necessary, check the certificate contents by using the Control Panel. To do this, click on **Start / Control Panel / Internet Options**, the 'Contents' tab and the button **Certificates**.

Open the certificate and use the 'Details' tab to select the corresponding value. For the applicant you will find, for example, the necessary ASN.1 Distinguished Names and their abbreviations here. The values listed from top to bottom in the certificates must be entered into the IKE key from left to right. Observe the use of upper and lower case!

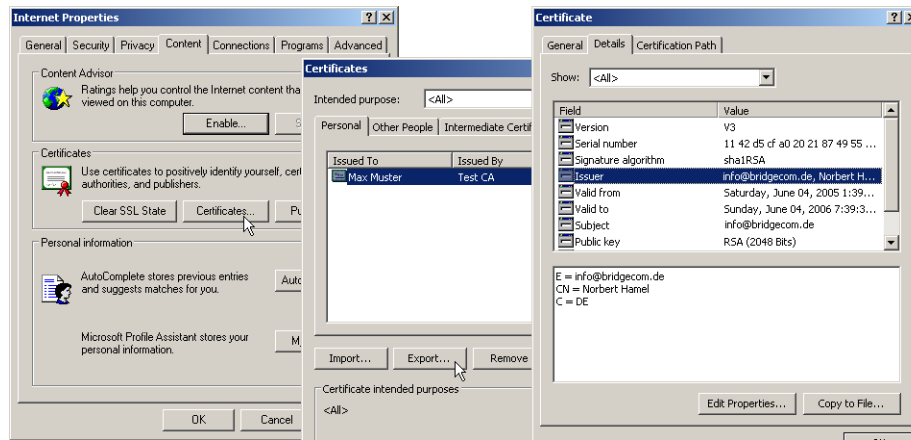

! Special characters in the ASN.1 Distinguished Names can be entered by typing in the hexadecimal ASCII codes after a leading backslash. For example, "\61" corresponds to a small "a".

! The display of certificates under Microsoft Windows shows for some values older short forms, for instance 'S' instead of 'ST' for 'stateOrPrvinceName' or 'G' instead of 'GN' for 'givenName'. Only use the new short forms 'ST' and 'GN'.

- In the IKE connection parameters, the default IKE proposal lists for incoming aggressive-mode and main-mode connections must be set to the proposal list 'IKE\_RSA\_SIG'. Also observe the settings in the default IKE group which are adjusted in the following step as necessary.

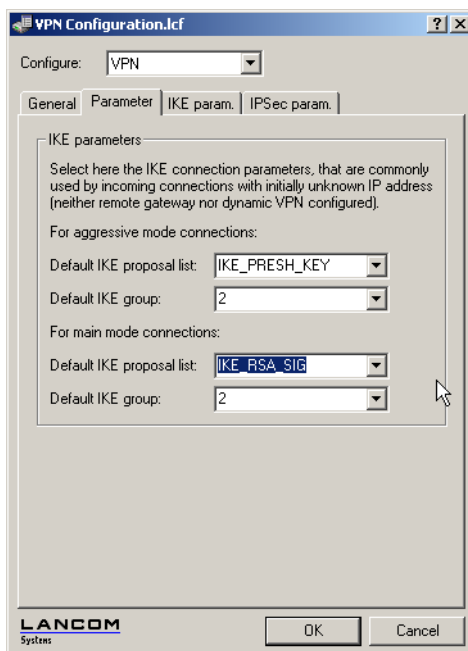

1. LANconfig: VPN / Parameter

WEBconfig: LCOS menu tree / Setup / VPN

- Finally, the VPN connection parameters must be set up to use the correct IKE proposals ('IKE\_RSA\_SIG'). The values for 'PFS group' and 'IKE group' must agree with the values set in the IKE connection parameters. Configuration with LANconfig

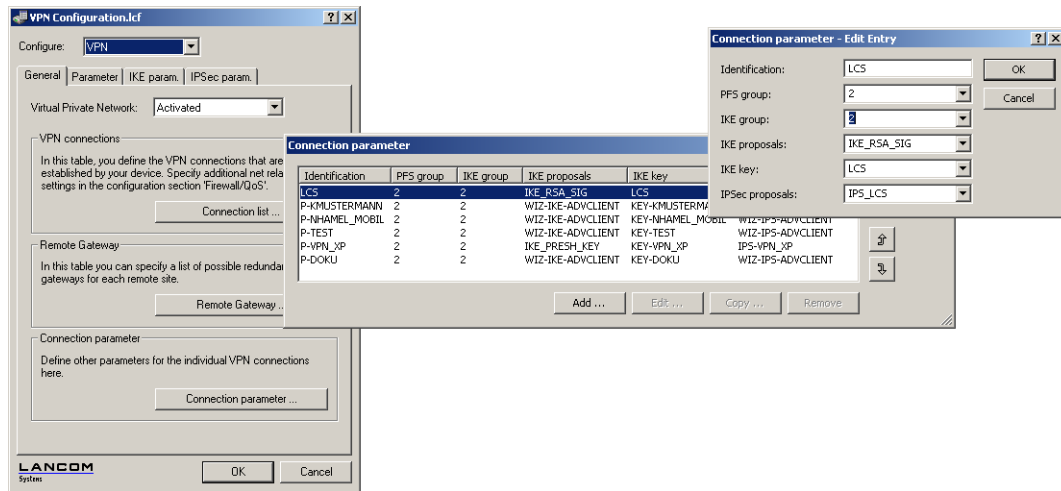

LANconfig: VPN / General / Connection parameters

WEBconfig: LCOS menu tree / Setup / VPN E VPN layers

## Addition(s) to LCOS 7.80

### Wildcard matching of certificates

#### Introduction

Generally speaking, the local identity and remote identity for certificate-based VPN connections are the certificate subjects. In the VPN configuration, these are stored in the form of (often complex) ASN.1 Distinguished Names (DN). During VPN negotiation, the local identity is used to select the certificate which is to be transmitted to the remote station, whereas the local value for the remote identity is compared with the received identity of the remote station and the subject of the received certificate.

Until now, the local and the remote identities had to be entered in full into the VPN configuration. Not only is this prone to error, it is sometimes desirable to specify only a part of the certificate subject. This is practical where different certificates with similar subjects are to be accepted automatically, for example where certificates can change, or where multiple parallel certificate hierarchies operate simultaneously.

This is facilitated by flexible identity comparison. The certificate subjects have to contain the components of an ASN.1 Distinguished Name (DN) (Relative Distinguished Names – RDNs) as included in the configured identities. The RDNs can be in any order. Also, the RDN values can include the wildcards '?' and '\*'. If the RDNs are to include wildcards, these must be entered in the form '\?' or '\\*'. Examples:

- Subject = '/CN=John Doe/O=\*ACME\*', DN = '/CN=John?Doe\*'
- Subject = '/CN=John Doe/O=\*ACME\*', DN = '/O=\\*ACME\*'

#### Configuration

This flexible method of identification comparison is activated or deactivated in the VPN configuration.

WEBconfig: LCOS menu tree / Setup / VPN

- Flexible ID comparison

Possible values:

- Yes, No

Default:

- No

Flexible identity comparison is used when checking the (received) remote identity and also for selecting the certificate based on the local identity.

## 11.6.14 Set up certificate-based VPN connections with the Setup Wizard

LANconfig is equipped with Setup Wizards with which you can set up certificate-based LAN coupling or RAS access via VPN.

- ! VPN connections that support certificates can only be set up if the LANCOM is programmed with the correct time and if the corresponding certificates are loaded into the device.

### LAN coupling

1. Choose the Wizard that connects two local area networks over VPN. In the appropriate dialog, select VPN connection authentication with certificates (RSA signature).
2. Enter the identities contained in the certificates for the local and remote devices. Be sure to use the information from each certificate in full and in the right order: The ASN.1-Distinguished Names listed in Windows from top to bottom in the certificates must be entered into LANconfig from left to right.

- ! Microsoft Windows displays some values in the certificates with outdated abbreviations, such as 'S' instead of 'ST' for 'stateOrProvinceName', or 'G' instead of 'GN' for 'givenName'. In these cases make sure that you use the current abbreviations 'ST' and 'GN'.

- ! The Telnet command `show vpn cert` displays the content of the device certificate in a LANCOM, including the entered Distinguished Names (DN) under "Subject". The Distinguished Names are displayed in reverse order here until LCOS 6.00 and in the usual order as of LCOS 6.10!

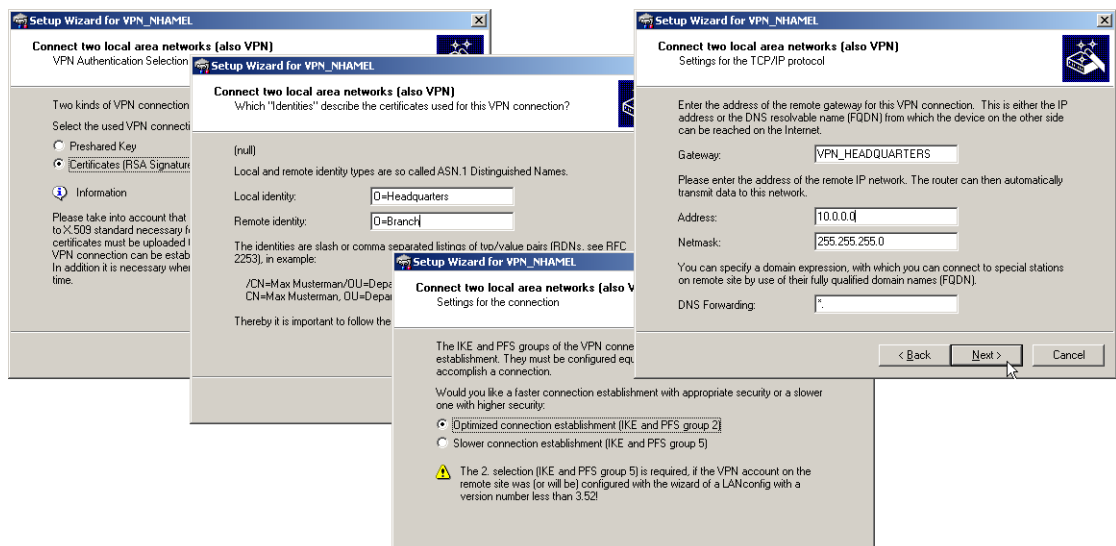

1. If available choose the optimized connection establishment with IKE and PFS group 2. Only choose group 5 for IKE and PFS if this is required by the remote device. This will be the case if, for example, the VPN remote device is configured with LANconfig 3.52 or earlier.
2. Enter the names of the VPN remote site, the IP address, the netmask for the remote network and, if applicable, the domain for the DNS forwarding. If required, activate the "Extranet" function and the "NetBIOS routing".

## RAS connections

RAS connections that support certificates can be set up for the LANCOM Advanced VPN Client or for any other VPN client with user-defined parameters. The LANCOM Standard VPN Client does not support certificates.

 Various parameters are requested depending on the choice of client or the options. This description shows all of the possible Wizard dialogs, some of which may not necessarily be relevant for your application.

1. Choose the Wizard that provides remote access over VPN. In the appropriate dialog, select VPN connection authentication with certificates (RSA signature). The default "Exchange Mode" is the Main Mode.

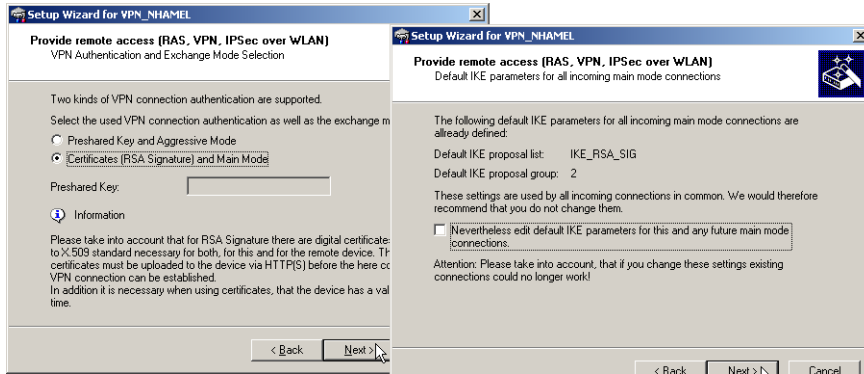

1. The configuration normally presents standard IKE parameters for incoming main mode connections in the standard IKE proposal list 'IKE\_RSA\_SIG'. If possible use the list of prepared IKE parameters.
2. If you wish to use different parameters for incoming main mode connections, you can adapt the standard IKE parameters to fit your requirements. You can either create a new list 'WIZ-IKE-MAIN-MODE' or you can select one of the existing IKE proposal lists as the new "Standard IKE proposal list". The list defined here will be used for all incoming main mode connections in the future. For a new IKE proposal list, you can select the encryption and authentication methods that are to be used by the client during the IKE negotiation.

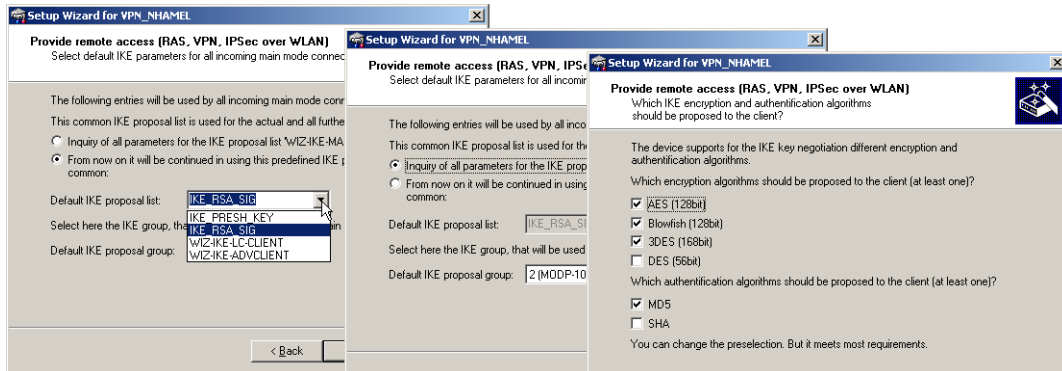



1. Enter the identities contained in the certificates for the local and remote devices. Be sure to use the information from each certificate in full and in the right order: The ASN.1-Distinguished Names listed in Windows from top to bottom in the certificates must be entered into LANconfig from left to right.

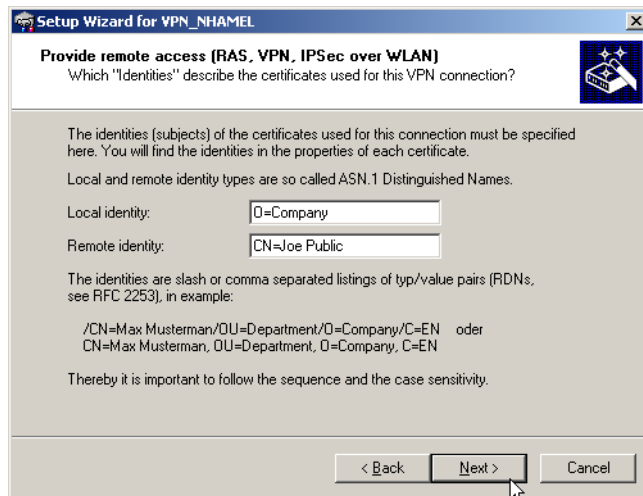

! Microsoft Windows displays some values in the certificates with outdated abbreviations, such as 'S' instead of 'ST' for 'stateOrProvinceName', or 'G' instead of 'GN' for 'givenName'. In these cases make sure that you use the current abbreviations 'ST' and 'GN'.

! The Telnet command `show vpn cert` displays the content of the device certificate in a LANCOM, including the entered Distinguished Names (DN) under "Subject". The Distinguished Names are displayed in reverse order here until LCOS 6.00 and in the usual order as of LCOS 6.10!

1. If available choose the optimized connection establishment with IKE and PFS group 2. Only choose group 5 as the PFS group if this is required by the client.

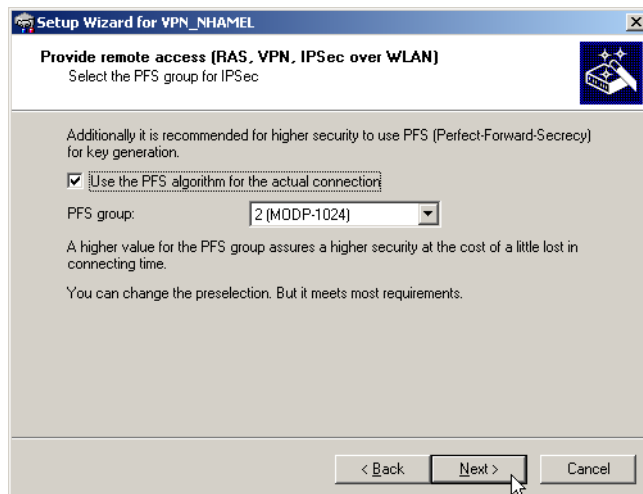

11 Virtual Private Networks (VPN)

1. The following dialogs define the encryption and authentication methods, the authentication header and the data compression that the client will use for the transfer of the payload data with IPSec. Use the preset values as much as possible as long as the client does not demand different settings.

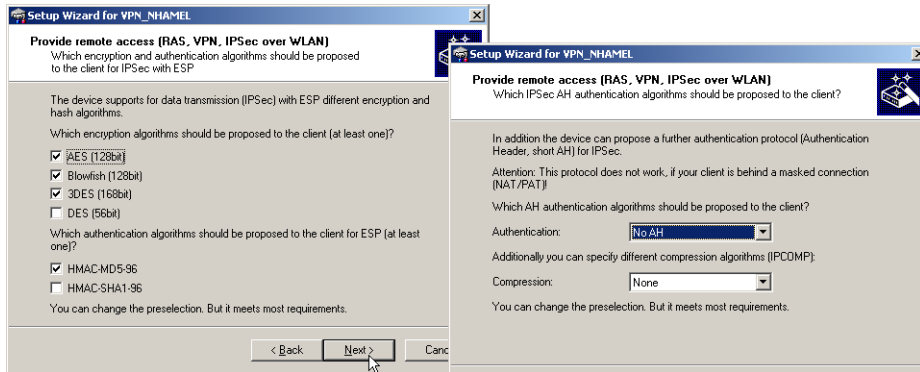

1. Enter the IP address of the client and for the address range that is to be accessible in the local network. If required, activate "NetBIOS routing".

### 11.6.15 Set up LANCOM Advanced VPN Client for certificate connections

To use the LANCOM Advanced VPN Client to dial-in to a LANCOM router, the appropriate profile settings must be adjusted to allow for the use of certificates.

1. In the IPSec General Settings for the profile, set the IKE policy to 'RSA signature'.

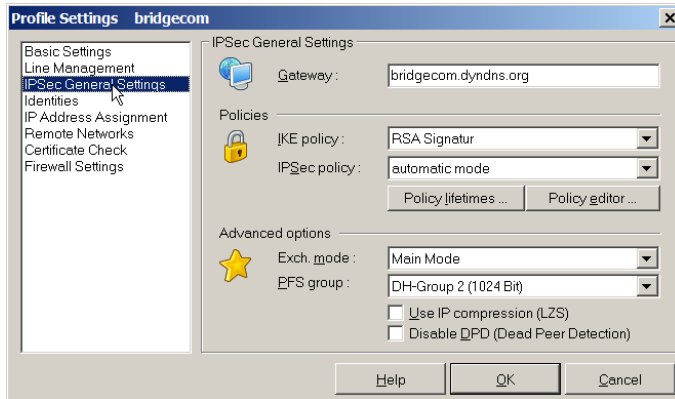

1. Switch the identity to 'ASN1 Distinguished Names'. The 'identity' can remain blank since this information is taken from the certificate.

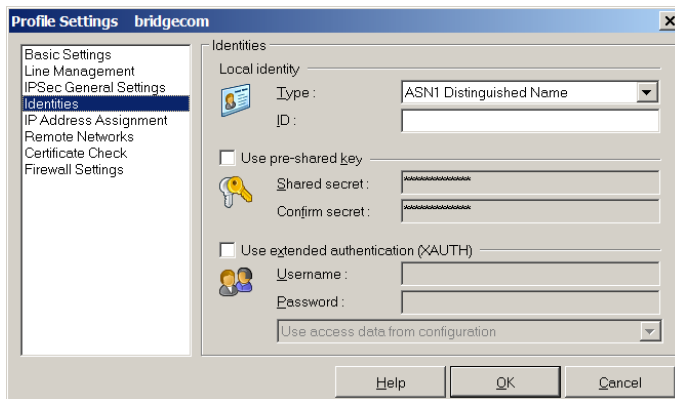

1. For the IP address assignment use the 'IKE Config Mode'.

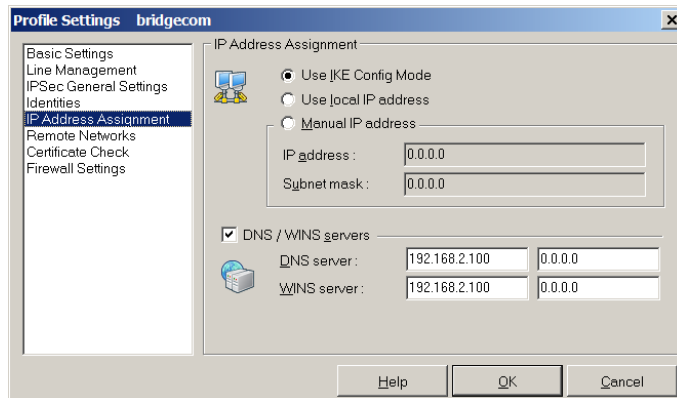

1. For the Certificate Check you can optionally place a limitation on the certificates accepted by the LANCOM Advanced VPN Client. To do this, you define the user and/or the issuer of the incoming certificate and, if applicable, the associated "fingerprint".

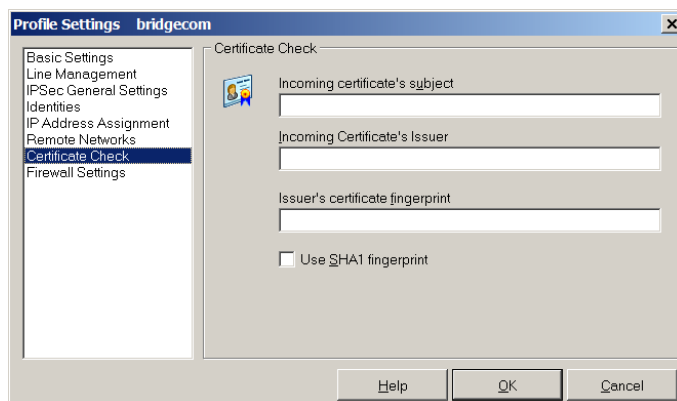

1. After storing the adapted connection profile, click on the menu item **Configuration / Certificates** to open the settings for the User Certificate.

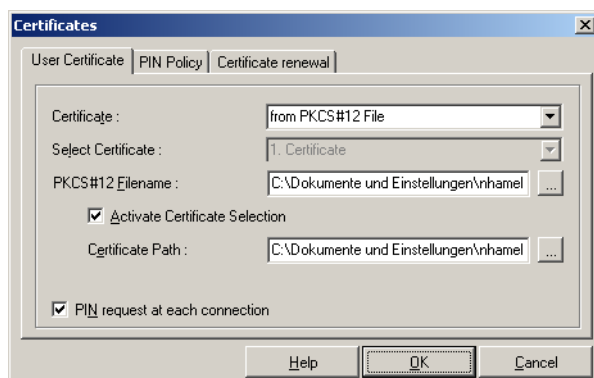

- Select the certificate type 'from PKCS#12 file' and set the required certificate file .
  - To work with various certificates, activate the option 'Certificate Selection' and enter the path for the folder where the certificate files are stored .

- Define whether or not the PIN (password) has to be entered before connection establishment . Alternatively, you can save the PIN in the LANCOM Advanced VPN Client under the menu item **Connection / Enter PIN** .

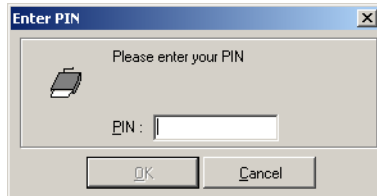

- If Certificate Selection is activated, the certificate corresponding to the connection can be chosen from a list displayed in the main window of the LANCOM Advanced VPN Client, as befits the selected profile.

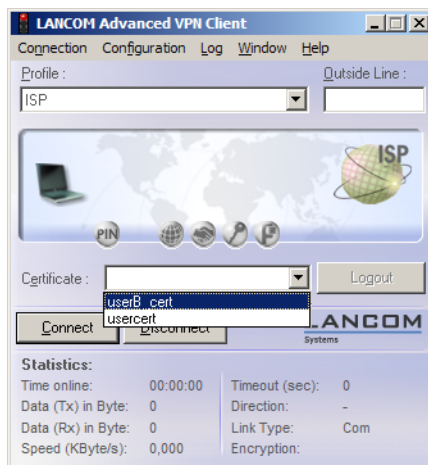

### 11.6.16 Simplified RAS with certificates

When dialling in, the identity of computers that use varying IP addresses is unknown at the initial stages of the IKE negotiation (Phase 1), so communication is facilitated by using default values for IKE proposal lists and IKE proposal groups. During negotiation, the identity is communicated and this is used to determine the parameters for phase 2 (IPSec proposal list and PFS group). For this to occur, every single user must be entered individually into the VPN router configuration.

With certificate-based RAS, the identity is communicated via the certificate. To avoid having to make individual user entries in the router configuration, common parameters for phase 2 can be defined for all users who are identified by certificate. All the user requires for simplified RAS is a valid certificate with a signature from the publisher of the root certificate in the device. Furthermore, the parameters used by the client during dial-in must agree with the default values in the VPN router.



Information about configuring the VPN client is available in the relevant documentation from the software manufacturer.

This function has to be activated to configure the simplified dial-in. The default parameters can be altered according to requirements.

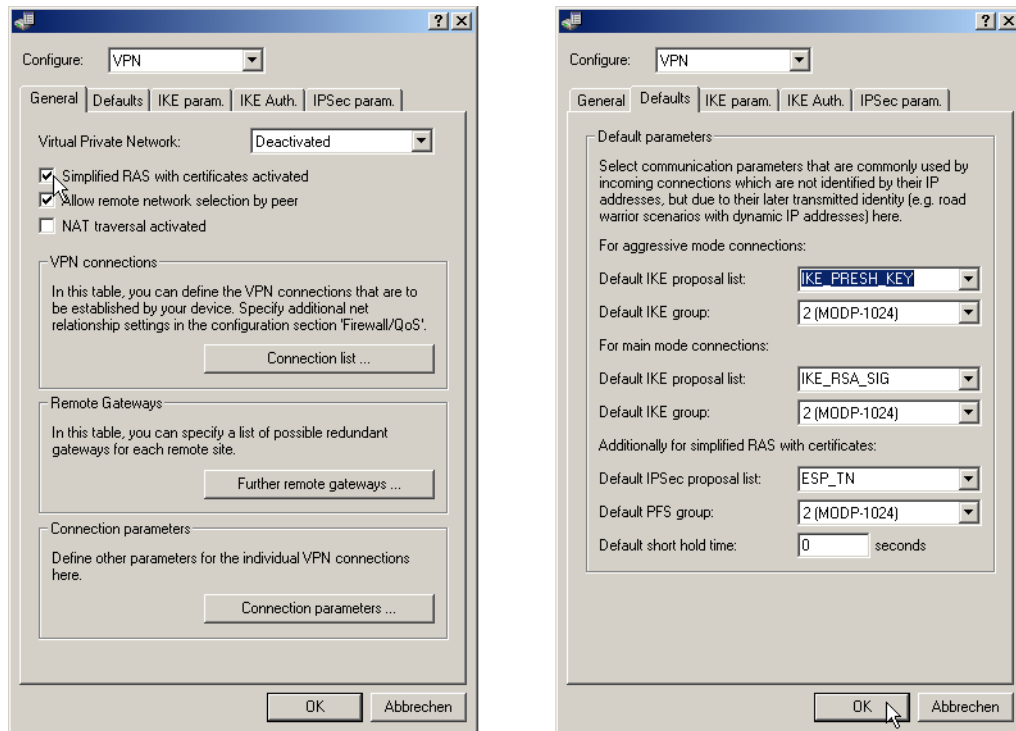

LANconfig: VPN / General and VPN / General / Defaults

WEBconfig: LCOS menu tree / Setup / VPN

By activating the simplified RAS with certificates, **all** clients that have a valid certificate signed by the publisher of the device's root certificate can dial in to the corresponding network. No further configuration of the router is necessary! Unwanted dial-ins are then prevented exclusively by using a CRL and blocking the certificates there.

### 11.6.17 Simplified network connection with certificates – proadaptive VPN

In cases where large network infrastructures are coupled via VPN, it is advantageous for the costs and effort in configuring a new subnetwork to be limited to the local VPN router and that the central dial-in router configuration remains unchanged. In order to achieve this simplified network connection, the dial-in devices transmit their identity with the help of a digital certificate.

If simplified dial-in with certificates is activated for the LANCOM Router at the headquarters, then the remote routers can suggest a network to be used for the connection during the IKE negotiation in phase 2. This network is entered, for example, when setting up the VPN connection on the remote router. The LANCOM Router at the headquarters accepts the suggested network when the option 'Allow remote station to select the remote network' is activated. Moreover, the parameters used by the client during dial in must agree with the default values in the VPN router.

! When configuring the dial-in remote stations, be sure to note that each remote station requests a specific network so that no network address conflicts arise.

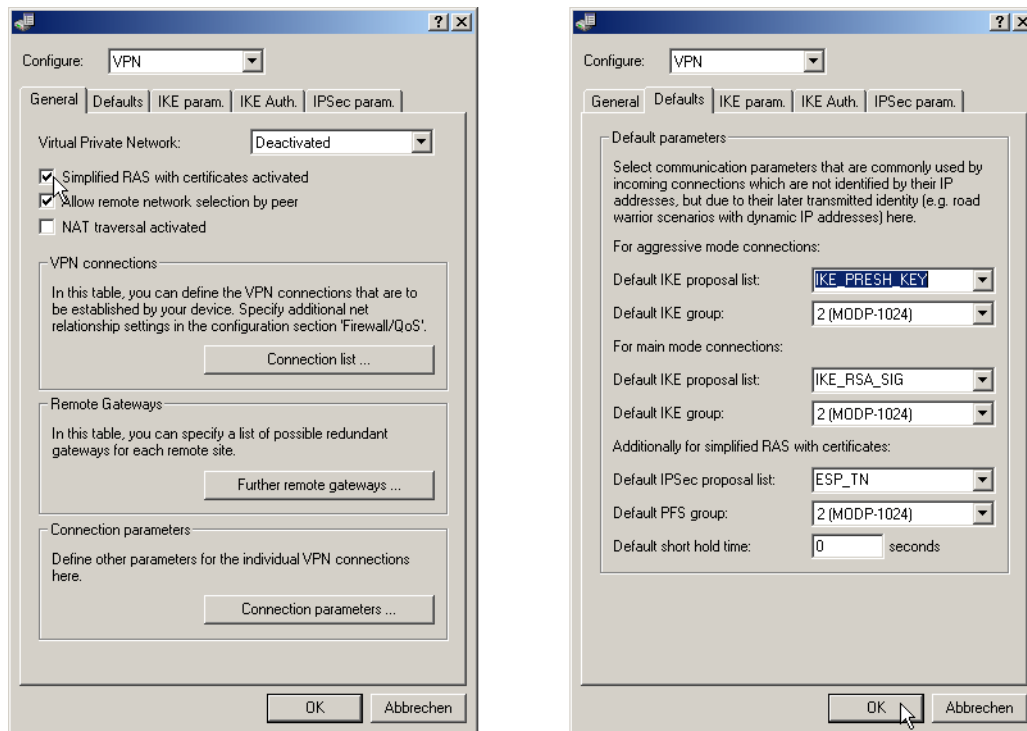

LANconfig: VPN / General and VPN / General / Defaults

WEBconfig: LCOS menu tree / Setup / VPN

! By activating the simplified RAS dial in, **all** remote routers that have a valid certificate signed by the publisher of the device's root certificate can dial in to the corresponding network. No further configuration of the router is necessary! Unwanted dial-in connections are then prevented exclusively by blocking the certificates and using a CRL. The simplified connection of networks with certificates is therefore limited to LANCOM Router models that support certificate revocation lists (CRL).

### 11.6.18 Request certificates using CERTREQ

During IPsec negotiations authenticated with the use of RSA signatures, some VPN gateways expect the remote station to request the certificates to be exchanged via a "certificate request" (CERTREQ). Among other things, this allows the gateway to select the certificate to be used providing that the gateway trusts more than one CA.

In order to establish a connection to these VPN gateways, the LANCOM VPN Router sends a corresponding CERTREQ when the connection is initiated. This is received by the publisher of the root certificate stored in the LANCOM.

### 11.6.19 Certificate revocation list - CRL

Certificates for VPN connections have a validity period by a start date and an end date. During this period, the certificate can be used to establish a VPN connection. Should an employee leave the company, then it should be possible for certificates, for example that were used for mobile VPN access, to be declared as invalid. This prevents continued access to the company network and does not require any changes to the VPN router configuration.

The certificate is physically located with the ex-employee and cannot be changed, which is why a certificate revocation list is of use. Certificates which are no longer valid are entered into the CRL, which are supported by Microsoft CA and OpenSSL, for example. The CRL is available from a suitable server. The URL to be used by a router to download the CRL

into its own memory is entered into the root certificate of the VPN router and/or into the configuration of the device itself.

The CRL is renewed by the CA on a regular basis, enabling changes in the CRL, such as withdrawn certificates, to be recognized by the VPN routers in good time. During the setup at the CA, a schedule is defined for the regular updating of the CRL. After an update to the CRL and its storage to the server (manual or automatic), the VPN router then has to update its information, too. To do this, the router reads out the validity period of the CRL and, briefly before expiry, attempts to load a current version. Alternatively, a regular update which depends on the validity period of the CRL can be set in the LANCOM.

When a connection is being established, the VPN router checks if the remote station's certificate is in the current CRL. Connections to remote stations without a valid certificate are rejected.

## Configuring the CRL function

Configuration of the CRL function involves the definition of the path to the CRL and additional parameters such as the update interval.

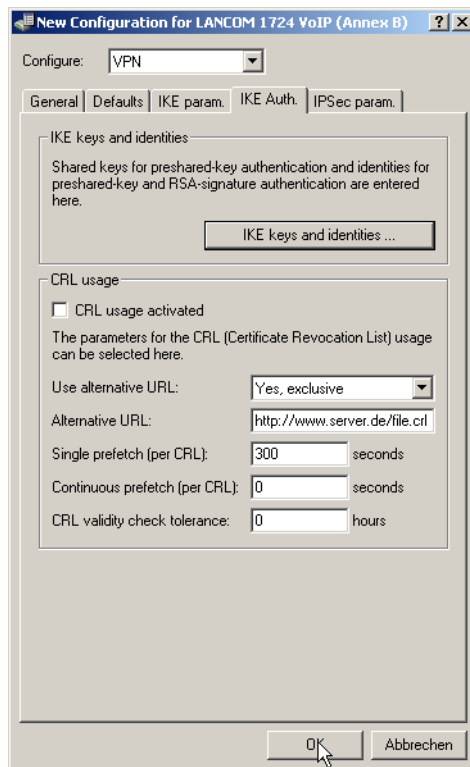

LANconfig: VPN / IKE Auth.

WEBconfig: LCOS menu tree / Setup / VPN / Certificates-and-Keys / CRLs

- CRL function [Default: Off]
  - Enabled: During the certificate check, the CRL (if available) will be considered as well.



If this option is activated but no valid CRL is available (e.g. if the server can't be reached), then all connections will be rejected and existing connections will be interrupted.

- Use alternative URL [Default: No]
  - No: Only the URL defined in the root certificate is to be used.
  - Yes, always: The alternative URL will always be used even if a URL is entered into the root certificate.
  - Yes, alternative: The alternative URL will only be used if there is no URL entered into the root certificate.

- Alternative URL
  - This is an alternative URL which can be used to retrieve a CRL.
- Single prefetch [Default: 300 seconds]
  - The point in time prior to expiry of the CRL when the new CRL can be loaded. This value is increased by a random value to prevent server overload from multiple simultaneous queries. Once within this time frame, any coinciding regular planned updates will be stopped.

---

ⓘ If the first attempt to load the CRL fails, new attempts are made at regular short intervals.
- Continuous prefetch [Default: 0 seconds]
  - The time period after which periodic attempts are made to retrieve a new CRL. Useful for the early retrieval of CRLs published at irregular intervals. The entry '0' disables regular retrieval.

---

ⓘ If with regular updates the CRL cannot be retrieved, no further attempts will be started until the next regular attempt.
- Validity tolerance
  - Even after expiry of the CRL, certificate-based connections will continue to be accepted for the period defined here. This tolerance period can prevent the unintentional rejection or interruption of connections if the CRL server should be temporarily unavailable.

---

ⓘ Within the time period defined here, even certificates in the CRL which have expired can still be used to maintain or establish a connection.

### CRL status display in LANmonitor

Information about the validity period and the publisher of the current CRL in the LANCOM can be inspected in LANmonitor.

#### 11.6.20 Diagnosis of VPN certificate connections

If the VPN connection establishment does not work as desired, then entering the following commands at the LANCOM console can provide useful information.

- `trace + vpn-status`  
Displays a trace of the current VPN connections.
  - `show vpn long`  
Displays the contents of the VPN configuration, including the entered Distinguished Names (DN).
  - `show vpn ca`  
Displays the content of the root certificate.
  - `show vpn cert`  
Displays the content of the device certificate.
- 
- ⓘ The Distinguished Names are displayed in reverse order here until LCOS 6.00 and in the usual order as of LCOS 6.10!



## 11.6.21 Addition(s) to LCOS 8.00

### Alternative URLs for CRLs

#### Introduction

The address from where a Certificate Revocation List (CRL) can be retrieved is usually included in the certificates (as `crDistributionPoint`). LCOS provides a table for alternative URLs. After the system boot the corresponding CRLs are automatically loaded from these URLs and used in addition to the lists mentioned in the certificates.

#### Configuration

The table for alternative URLs can be found in the following menus:

LANconfig: Certificates / SCRL-Client / Alternative URLs

WEBconfig: LCOS menu tree / Setup / Certificates / CRLs / Alternative-URL-Table

- Alternative-URL

Geben Sie hier die URL an, von der eine CRL abgeholt werden kann.

- Possible Values:

Valid URL, max. 251 characters.

- Default:

Empty

## 11.6.22 Addition(s) to LCOS 8.50

### OCSP client for certificate validation

#### Introduction

The Online Certificate Status Protocol (OCSP) provides a way to verify the status of certificates, for example when establishing VPN connections. The devices use this protocol to investigate whether the issuer has revoked the certificate before its expiry, so marking it as invalid.

Certificate issuers update the status of all issued certificates on a special server, the OCSP responder. The OCSP client (e.g. a VPN router that wants to establish a connection) uses the HTTP protocol to send an OCSP request to the responder to verify the certificate. The responder answers with a signed response, which the OCSP client uses to verify its validity. The message from the OCSP responder describes one of the following conditions:

- Good: The verified certificate has not been revoked.
- Revoked: The verified certificate has been revoked and may not be used to establish VPN connections.
- Unknown: The OCSP responder cannot determine the status of the certificate. This may be because the OCSP responder does not recognize the certificate issuer because the certificate has been faked and therefore has not been entered into the database of the OCSP responder.

You can use the OCSP to complement or substitute certificate verification by certificate revocation lists (CRL). OCSP offers the following advantages when compared to CRLs:

- The issuers generate the CRLs at specific time intervals and, in the ideal case, distribute the CRLs to the devices which use the certificates for establishing VPN connections. The reliability of this check thus depends on the speed with which CRLs in the devices are updated. However, certificate verification through an OCSP responder is always "online", i.e. it is automatically updated. The operator of the OCSP responder can automatically synchronize their data with that of the CA or CAs, thus ensuring that they are up to date at all times.

- Using certificate revocation lists for certificate verification takes up a considerable amount of device memory, especially if the CRLs are large. Querying certificate status from an OCSP responder, on the other hand, is independent of the number of CAs and certificates being used, and is therefore more scalable.
- As the CRL method does not allow for unknown certificates, this method cannot detect fake certificates. The OCSP responder, depending on its configuration, responds to a request about an unknown certificate with a negative evaluation.

### Additions to the menu system

#### Responder profile table

This table contains information on the Certificate Authorities (CAs), whose certificates are evaluated by the OCSP client by sending a request to an OCSP responder.

**Telnet path:** /Setup/Certificates/OCSP-Client

#### Profile name

Enter here the name of an OCSP-responder profile to be referenced by the OCSP client in the CA profile table.

**Telnet path:** /Setup/Certificates/OCSP-Client/Ca-Profile-Table

#### Possible values:

- Maximum 32 alphanumerical characters

**Default:** Blank

#### URL

Enter the URL for the OCSP client to access the OCSP responder.

**Telnet path:** /Setup/Certificates/OCSP-Client/Ca-Profile-Table

#### Possible values:

- Valid URL with a maximum of 251 alphanumeric characters

**Default:** Blank

#### CA profile table

This table contains information on the Certificate Authorities (CAs), whose certificates are evaluated by the OCSP client by sending a request to an OCSP responder.

**Telnet path:** /Setup/Certificates/OCSP-Client

#### Profile name

Enter here the name of a CA profile to be used by the OCSP client for a particular CA.

**Telnet path:** /Setup/Certificates/OCSP-Client/Ca-Profile-Table

#### Possible values:

- Maximum 32 alphanumerical characters

**Default:** Blank

#### CA distinguished name

Enter the distinguished name of the CA, whose certificates are evaluated by the OCSP client with this profile name.

**Telnet path:** /Setup/Certificates/OCSP-Client/Ca-Profile-Table

#### Possible values:

- Maximum 251 alphanumeric characters

**Default:** Blank

### Prefer AIA

Certificates used for establishing VPN connections optionally include the URL of the relevant OCSP responder in the field Authority Info Access (AIA). This item defines whether the OCSP client prefers to use the URL from this entry in the CA profile table or the URL from the AIA field, if available.

**Telnet path:** /Setup/Certificates/OCSP-Client/Ca-Profile-Table

**Possible values:**

- No: The OCSP client always uses the URL from this CA-profile table entry and ignores the URL in the AIA field.
- Yes: The OCSP client uses the URL from the AIA field (if specified) and ignores the URL from this CA profile table entry.

**Default:** No

### Responder profile name

This item selects the responder profile used by the OCSP client to evaluate certificates from this CA.

**Telnet path:** /Setup/Certificates/OCSP-Client/Ca-Profile-Table

**Possible values:**

- Select from the list of profile names in the table [2.39.6.2 Responder profile table](#), maximum 32 alphanumeric characters.

**Default:** Blank

---

 If the field for the responder profile name is left empty, the machine evaluates the certificates from the CA defined here not with OCSP, but with the help of a CRL.

### Source interface

This is where you can configure an optional sender address to be used instead of the one otherwise automatically selected for the destination address.

If you have configured loopback addresses, you can specify them here as sender address.

**Telnet path:** /Setup/Certificates/OCSP-Client/Ca-Profile-Table

**Possible values:**

- Name of the IP networks whose address should be used
- "INT" for the address of the first intranet
- "DMZ" for the address of the first DMZ
- LBO to LBF for the 16 loopback addresses
- Any valid IP address

**Default:** 00.0.0

---

 If the list of IP networks or loopback addresses contains an entry named 'DMZ' then the associated IP address will be used. Name of a loopback address.

### Certificate evaluation

This item defines how the device behaves if certificate evaluation fails. During connection establishment, the OCSP client first queries the OCSP responder about the validity of the certificate. If the certificate is about to expire, the OCSP client automatically repeats the query about the validity before the certificate expires.

**Telnet path:** /Setup/Certificates/OCSP-Client/Ca-Profile-Table

**Possible values:**

- **Strict:** The device will block connection establishment if the OSCP responder answers requests for the certificate used during connection establishment in one of the following ways:
  - The OSCP responder does not answer
  - The OSCP responder responds that the certificate is unknown
  - The OSCP responder recognizes the certificate and marks it as revoked
- **Loose:** The device will block connection establishment if the OSCP responder answers requests for the certificate used during connection establishment in one of the following ways:
  - The OSCP responder does not answer
  - The OSCP responder responds that the certificate is unknown

**Default:** Strict

! If necessary, you can log and review the results of certificate evaluation by the OSCP responder with SYSLOG, SNMP traps and relevant traces.

**Syslog events**

The OSCP client can optionally generate SYSLOG messages with information on the results of certificate checks by the OSCP responder.

**Telnet path:** /Setup/Certificates/OCSP-Client/Ca-Profile-Table**Possible values:**

- **Yes:** The OSCP client generates SYSLOG messages
- **No:** The OSCP client does not generate SYSLOG messages

**Default:** Yes

## 11.7 Multi-level certificates for SSL/TLS

New with LCOS 7.6:

- Multi-level certificates for SSL/TLS

### 11.7.1 Introduction

Larger or geographically dispersed organizations often make use of multi-level certificate hierarchies that rely on one or more intermediate CAs to issue certificates. The interim CAs themselves are certified by the Root CA.

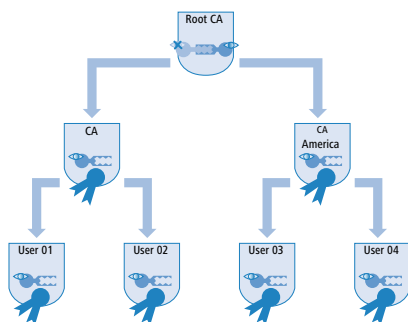

To authenticate final certificates, it must be possible to check the entire certificate hierarchy.

## 11.7.2 SSL/TLS with multi-level certificates

For applications based on SSL/TLS (e. g. EAP/802.1x, HTTPS or RADSEC), the SSL (server) certificate together with the private key and intermediate level CA certificate(s) are loaded into the device as a PKCS#12 container.

The remote devices establishing a connection only have to send their own device certificates to the LANCOM. The certificate chain is checked for validity in the LANCOM.

## 11.7.3 VPN with multi-level certificates

For the certificate-based establishment of VPN connections, the following are stored to the file system in the LANCOM: A private key, a device certificate, and the CA certificate. With single-layer certificate solutions this can be handled with the individual files or with a PKCS#12 file. After uploading and entering the password, a container is separated into the three components indicated above.

In the case of a multi-level certificate hierarchy, however, a PKCS#12 container has to be used that includes the CA certificates from all levels in the certificate chain. After uploading and entering the password, the private key, the device certificate and the certificate from the next CA "above" the LANCOM are unpacked—the other certificates remain in the PKCS#12 container. The unpacked certificates and the certificates from the container are imported when the VPN configuration is updated. A remote station establishing a VPN connection transfers its own device certificate only and not the entire chain. The LANCOM then checks this certificate against the hierarchy available to it.

---

 The certificate structures in the two stations must match to one another, i.e. the hierarchy in the VPN device making the request should not demand certificates that are not included in the other VPN device's hierarchy.

## 11.8 Certificate enrollment via SCEP

An increasing number of certificate-based VPN connections are being used to provide secure communications via public networks. The high levels of security provided by certificates comes at the price of significantly higher levels of effort in the administration and distribution of certificates. Most of this effort arises at branch offices or home offices within a geographically dispersed network structure.

A LANCOM VPN Router router requires the following components to establish a certificate-based VPN connection from a remote site to network at headquarters:

- The Root CA's certificate with the CA's public key. The headquarters also requires a certificate issued by the same CA.
- The device's own certificate with its own public key. This certificate is signed with the CA's private key and serves identity confirmation.
- Own private key.

---

 The current version of LCOS supports only a public key infrastructure (PKI) with a root CA.

In the case of a conventionally structured VPN with certificates, the keys and certificates have to be loaded into each device manually and exchanged before they expire. The Simple Certificate Enrollment Protocol (SCEP) enables a secure and automatic distribution of certificates via a suitable server, so reducing the effort of roll-out and maintaining certificate-based network structures. There is no need for the key pair for the device to be generated by an external application and subsequently transferred to the device. Instead, the key pair is generated directly by the LANCOM VPN Router itself; the private portion of the key never has to leave the device, which results in a significant gain in security. A LANCOM VPN Router can automatically retrieve the CA root certificate and its own certificate from a central location.

### 11.8.1 SCEP server and SCEP client

Provisioning and administration of the certificates is handled by an SCEP server that fulfills the usual function of a Certificate Authority (CA) as well as the SCEP functions. This server can, for example, be implemented as a Windows

2003 Server CA by using a special plug-in (mscep.dll). There are also a number of other CA solutions which work with SCEP, such as the OpenSource solution OpenCA ([www.openca.org](http://www.openca.org)).

The SCEP extension such as with mscep.dll creates an additional instance on the server and processes requests from SCEP clients for forwarding to the actual CA. This instance is referred to as the Registration Authority (RA).

The VPN devices (i.e. the LANCOM VPN Router) are SCEP clients that attempt to automatically retrieve the necessary certificates from the central server. Also generally required by the SCEP procedure are the RA (Registration Authority) certificates as signed by the CA. For VPN operations the LANCOM VPN Routers mainly require valid system certificates (device certificates). Any other certificates which may be in use only apply to the SCEP procedure.

## 11.8.2 Distributing certificates

In brief, the procedure for distributing certificates via SCEP is as follows:

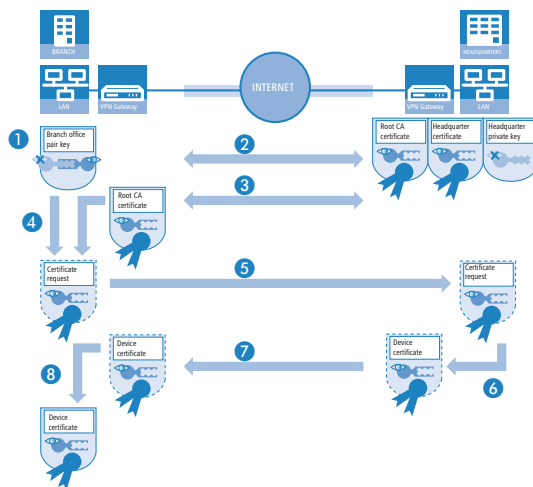

1. Generate key pair in the LANCOM VPN Router.

A key pair is generated in the LANCOM VPN Router. The public part of this key pair is later sent together with the request to the SCEP server. The private key remains in the SCEP client (LANCOM VPN Router). The fact that the private key never has to leave the device is a major security gain over manual certificate distribution, for example with PKCS#12 containers.

2. Retrieve CA and RA certificates.

For communication with the RA/CA, the appropriate RA and CA certificates must be available in the LANCOM VPN Router. To ensure that CA certificates retrieved via SCEP do genuinely originate from the CA, an automated check can be carried out with the use of a fingerprint which is defined in advance. SCEP itself has no mechanism for clients to conduct automated authentication of CA certificates. If the administrator of the LANCOM VPN Router does not have direct access to the CA then the fingerprint can be checked manually, for example with a telephone call to the CA admin.

3. Generate and encrypt the request for a device certificate.

To place a request for a system or device certificate, the SCEP client collects all of the configured information such as the identity of the requester device and, if applicable, the "challenge phrase" or password for automatic request processing by the SCEP server. This request is signed with the private key.

4. Send the request to the SCEP.

The SCEP client then sends the request along with its public key to the SCEP server.

5. Check the certificate request on the SCEP server and issue the device certificate.

The SCEP server can decrypt the request and subsequently issues a system or device certificate to the requester. SCEP has two different methods for request processing:

- Automatic processing requires the requester's authenticity to be assured by means of the challenge phrase. The challenge phrase can, for example, be generated automatically by a Windows CA server using mscep.dll. The phrase is valid for one hour. If the challenge phrase submitted with the certificate request agrees with the valid value, the system certificate is issued automatically.
  - For manual processing, the SCEP server puts the certificate request "on hold" until the acceptance or rejection has been received from the CA administrator. While waiting, the SCEP client regularly checks with the SCEP server to see if the certificate has been issued yet.
6. Retrieve device certificate from the SCEP server
 

Once the certificate has been issued, the client's regular polling informs it that the certificate is ready for retrieval.
  7. Check the device certificate and present it for VPN operation

### 11.8.3 Configuring SCEP

To configure SCEP, global parameters are defined for SCEP operations and for the CAs where the device certificates are to be retrieved.

 In addition to the configuration of the SCEP parameters, it may be necessary to adapt the VPN configurations.

WEBconfig: LCOS menu tree / Setup / VPN / Certificates-and-Keys / SCEP

#### Global SCEP parameters

- Active
 

Switches SCEP on or off.

  - Values: Yes, No
  - Default: No
- Retry-After-Error-Interval
 

Interval in seconds between retries after errors of any type.

  - Default: 22
- Check-Pending-Requests-Interval
 

Interval in seconds for checks on outstanding certificate requests.

  - Default: 101
- Device-Certificate-Update-Before
 

Preparation time in days for the timely request for new system certificates (device certificates).

  - Default: 2
- CA-Certificate-Update-Before
 

Preparation time in days for the timely retrieval of new RA/CA certificates.

  - Default: 1

#### Actions

- Reinit
 

Starts the manual reinitialization of the SCEP parameters. As with the standard SCEP initialization, the necessary RA and CA certificates are retrieved from the CA and stored within the LANCOM Router's file system so that they are **not yet** ready for use in VPN operations.

- If the available system certificate fits to the retrieved CA certificate, then the system certificate, CA certificate and the device's private key can be used for VPN operations.
- If the existing system certificates **do not** fit to the retrieved CA certificate, then the next step is for the SCEP server to submit a new certificate request. Only once a new system certificate that fits to the retrieved CA certificate has been issued and retrieved can the system certificate, CA certificate and the device's private key can be used for VPN operations.
- Update  
Manually triggers a request for a new system certificate, irrespective of the remaining period of validity. A new key pair is generated at the same time.
- Clear-SCEP-Filesystem  
Starts a clean-up of the SCEP file system.
  - Deleted are: RA certificates, pending certificate requests, new and inactive CA certificates, new and inactive private keys.
  - Retained are: System certificates currently in use for VPN operations, associated private keys, and the CA certificates currently in use for VPN operations.

## Configuring the CAs

- Name  
Configuration name of the CA.
- URL  
The CA's URL.
- DN  
Distinguished name of the device. With this parameter the CAs are assigned to system certificates (and vice versa) on the one hand. On the other hand this parameter is also important for evaluating whether received or available certificates match with the configuration.
- Enc-Alg  
This algorithm encrypts the payload of the certificate request.
  - Values: DES, 3-DES, Blowfish.
  - Default: DES.
- Identifier  
CA identifier (as required by some web server to identify the CA).
- RA-Autoapprove  
Some CAs provide the option of using an earlier certificate issued by this CA as proof of authenticity for future requests. This option defines whether an existing system certificate should be used to sign new requests.
  - Values: Yes, No.
  - Default: No.
- CA-Signature-Algorithm  
The certificate request is signed with this algorithm.
  - Values: MD5, SHA1.
  - Default: MD5.
- CA-Fingerprint-Algorithm



Algorithm for signing the fingerprint. This determines whether the CA certificate is to be checked by means of fingerprint, and which algorithm is used for this. The CA fingerprint has to agree with the checksum which results when this algorithm is applied.

- Values: Off, MD5, SHA1.
- Default: Off.

- CA-Fingerprint

The authenticity of a received CA certificate can be checked by means of the the checksum (fingerprint) entered here (corresponding to the set CA fingerprint algorithm).

## Configuring the system certificates

- Name

The certificate's configuration name.

- CADN

Distinguished name of the CA. With this parameter the CAs are assigned to system certificates (and vice versa) on the one hand. On the other hand this parameter is also important for evaluating whether received or available certificates match with the configuration.

- Subject

Distinguished name of the subject of the requester.

- ChallengePwd

Password (for the automatic issue of device certificates on the SCEP server).

- SubjectAltName

Further information about the requester, e.g. domain or IP address.

- KeyUsage

Any comma-separated combination of:

- digitalSignature
- nonRepudiation
- keyEncipherment
- dataEncipherment
- keyAgreement
- keyCertSign
- cRLSign
- encipherOnly
- decipherOnly
- critical (possible but not recommended)

- Extended Key Usage

Any comma-separated combination of:

- critical
- serverAuth
- clientAuth
- codeSigning
- emailProtection
- timeStamping
- msCodeInd
- msCodeCom

- msCTLSign
- msSGC
- msEFS
- nsSGC
- 1.3.6.1.5.5.7.3.18 für WLAN-Controller
- 1.3.6.1.5.5.7.3.19 für Access Points im Managed-Modus
- Device-Certificate-Keylength
 

The length of the key to be generated for the device itself.
- **Application**

Shows the application of the registered certificates. It will be asked for the registered certificates only for the corresponding application.

## 11.9 NAT Traversal (NAT-T)

The insufficient number of publicly valid IP addresses has led to the development of procedures such as IP masquerading or NAT (Network Address Translation), where a whole local network is masked by a single, publicly valid IP address. In this way, all clients in a LAN use the same IP address to exchange data with public networks such as the Internet. The assignment of the incoming and outgoing data packets to the different participants in the network is ensured by connecting the internal IP addresses to corresponding port numbers.

This process has proven its worth in the last few years and has since become the standard in almost all Internet routers. However, new difficulties arise when the hidden data packets are processed using VPN. As data connections over VPN are highly secured, mechanisms such as authentication and encryption are of great importance here.

Converting internal IP addresses to the gateway's central, publicly valid IP address and converting source and target ports can lead to problems in many applications, for example where the UDP port 500 that is usually used during the IKE negotiation has been changed and the IKE can no longer be successfully completed as a result. The address change using NAT is therefore assessed by a VPN gateway as a security-critical data packet change, the VPN negotiation fails and no connection is made. In fact these problems occur, for example, when you dial in using some UMTS mobile telephone networks where the network operator's servers do not support the address conversion in combination with IPSec-based VPNs.

So you can successfully create a VPN connection even in such cases, NAT-T (NAT Traversal) provides a process that can overcome the problems described when handling data packets with changed addresses.

---

 NAT-T can only be used with VPN connections that use ESP (Encapsulating Security Payload) for authentication. Unlike AH (Authentication Header), ESP does not consider the IP header of the data packets when determining the hash value for authentication. The hash value calculated by the receiver is therefore also equivalent to the hash value entered in the packets.

If the VPN uses AH for authentication, then in principle no connection can be established over sections with Network Access Translation, as the AH hash values similarly change when the IP addresses change, and the recipient would classify the data packets as untrustworthy.

The NAT Traversal process eliminates the problems that occur when establishing a VPN connection at the end points of the VPN tunnel. The following scenarios can be distinguished from one another:

- A member of the field staff uses a LANCOM Advanced VPN Client to dial into the company VPN router **without** "VPN pass-through" support (i.e. IPSec masking) but **with** Network Address Translation.

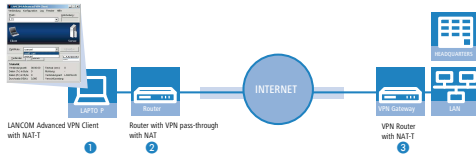

- Both tunnel end points LANCOM Advanced VPN Client and VPN router support NAT-T and can therefore also establish a VPN connection through the intermediary router.

- Router as a NAT device between the VPN end points performs straight forward NAT address conversion.

This router does not require NAT but firewall ports 500 and 4500 must be open in order to enable NAT communication between both tunnel end points.

- In the second example application, the travelling field worker dials in to the network at the headquarters with his notebook and a mobile telephone or modem.

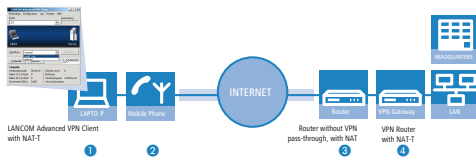

- At the headquarters, the VPN router is located behind a terminating router, which only provides Internet access with the address conversion.
  - Both tunnel end points LANCOM Advanced VPN Client and VPN router support NAT-T and can therefore establish a VPN connection, as in the first example.
  - In the terminating router, the firewall ports 500 and 4500 have to be activated, as does port forwarding.
- In both of these cases, the two ends of the connection are the straight-forward NAT routers and . The VPN connection is established between the LANCOM Advanced VPN Client and VPN router.

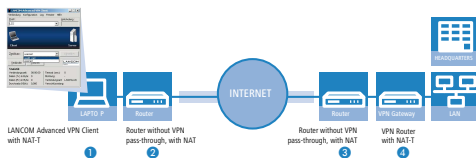

- The two routers and have to permit the NAT-T connection between the two tunnel endpoints in that the firewall ports 500 and 4500 are activated, and port forwarding has to be activated in the terminating router at the headquarters, as well.

To enable this process, both ends of the VPN connection have to work with NAT-T. The process of establishing the VPN connection (reduced to the NAT-T-relevant operations) appears as follows:

1. At an early stage of the IKE negotiation, there is a check to see if both ends of the VPN connection are NAT-T-compatible.
2. In the second step, there is a check to see if the address is converted to NAT on the section between the two tunnel end points, and at what point in the connection the NAT devices are located.
3. To deal with problems with ports that may have changed, all negotiation and data packets are subsequently sent only via UDP port 4500 when a NAT device has been detected.



If the LANCOM functions as a NAT router between the VPN end points, ensure that UDP ports 500 and 4500 are activated in the firewall when you use NAT-T! This port is activated automatically if you use the firewall assistant in LANconfig.

If the VPN connections are first created on devices with LCOS version 5.20 or above using the VPN assistant and later with the firewall assistant from LANconfig, then no additional firewall settings are required for the NAT router.

1. In the diagram below, the data packets are packed again into UDP packets (UDP encapsulation) and are also sent using port 4500. As a result of this additional encapsulation, changing the IP addresses for the VPN negotiation is no longer relevant and the VPN tunnel can be established without any problems. At the other end of the connection, the IP data is released again by the additional UDP header and can be processed by the router without further action.

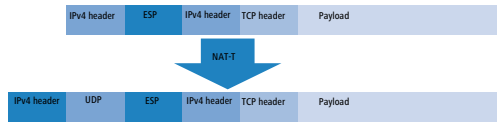

In order to use this process, both ends of the VPN connection (such as the WLANmonitor and a LANCOM router) have to use NAT-T.

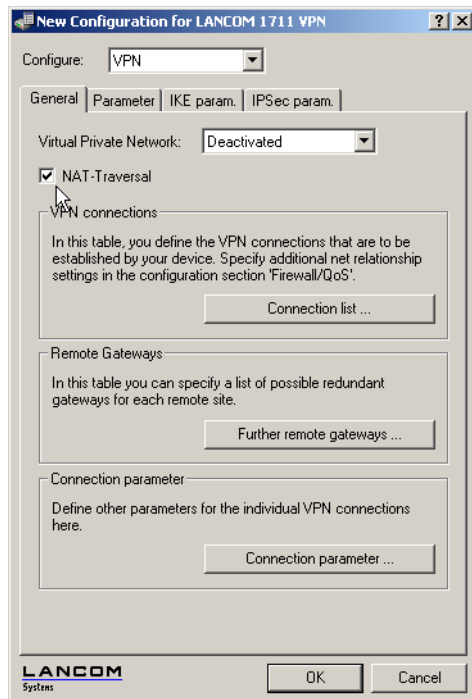

LANconfig: VPN / General

WEBconfig: LCOS menu tree / Setup / VPN E NAT-T Operating

## 11.10 Extended Authentication Protocol (XAUTH)

### 11.10.1 Introduction

RADIUS servers are often used to authenticate users for remote sites dialing-in over WAN connections (such as via PPP). Over time, conventional WAN connections increasingly gave way to secure (encrypted) and more cost-effective VPN connections. However, the structure of VPN connections over IPsec with IKE does not permit unidirectional authentication of users by RADIUS or similar technologies.

The Extended Authentication Protocol (XAUTH) provides the ability to extend authentication in the negotiation of IPsec connections by an additional level in which user data can be authenticated. An additional authentication with XAUTH user name and XAUTH password is performed between the first and second IKE negotiation phases. This authentication

is protected by the encryption negotiated in advance. A RADIUS server can be used for this authentication, enabling existing RADIUS databases to continue to be used in the migration of dial-in clients to use VPN connections. Alternatively, authentication can use an internal user table of the device.

**!** In order to make XAUTH particularly secure, dial-in via RSA-SIG (certificates) was to be used instead of the preshared key method (PSK) whenever possible. Here it is important to ensure that the VPN gateway accepts only the certificate of the correct remote site (and not all certificates issued by the same CA).

### 11.10.2 XAUTH in LCOS

In the LANCOM, the XAUTH protocol uses entries in the PPP table for remote site authentication. Use of the entries in the PPP table is dependent on which direction the connection is established, i.e. on the XAUTH operating mode:

XAUTH operating mode	Server	Client
XAUTH user name	Remote site from the PPP table.  The PPP-table entry is selected for which the PPP remote site corresponds to the transferred XAUTH user name.  The PPP remote site must also match the VPN remote site used.	User name from the PPP table.  The entry selected from the PPP table is that for which the PPP remote site corresponds to the VPN remote site used.
XAUTH password	Password from the PPP table.	Password from the PPP table.

**!** In LCOS version 7.60 in XAUTH operating mode, the XAUTH user name has to agree with the name of the VPN remote site. For this reason only one user can be authenticated by XAUTH for each VPN remote site. Authentication by RADIUS server is not available with LCOS 7.60.

### 11.10.3 Configuring XAUTH

The application of the XAUTH protocol is set up separately for each VPN remote site. Only the XAUTH operating mode is specified.

LANconfig: VPN / General / Connection list

The screenshot shows the 'Connection list - New Entry' dialog box with the following configuration:

- Name of connection: XAUTH
- Short hold time: 0 seconds
- Dead Peer Detection: 0 seconds
- Extranet address: 0.0.0.0
- Gateway: xauth.mylancom.com
- Connection parameters: (empty dropdown)
- Rule Creation: Auto
- Dynamic VPN connection (only with compatible remote stations):
  - No dynamic VPN
  - Dynamic VPN (a connection is created to transmit IP addresses)
  - Dynamic VPN (IP addresses are transmitted without establishing a connection if possible)
  - Dynamic VPN (an ICMP packet will be sent to transmit IP addresses)
  - Dynamic VPN (an UDP packet will be sent to transmit IP addresses)
- IKE exchange (only in conjunction with "No dynamic VPN"):
  - Main mode
  - Aggressive mode
- IKE-CFG: Off
- XAUTH: Server
- Routing tag: 0

WEBconfig: Setup / VPN / VPN peers

- XAUTH

Enables the use of XAUTH for the VPN remote site selected.

Possible values:

- Client: In the XAUTH client operating mode, the device starts the initial phase of IKE negotiation (Main mode or Aggressive mode) and then waits for the authentication request from the XAUTH server. The XAUTH client responds to this request with the user name and password from the PPP table entry in which the PPP remote site corresponds to the VPN remote site defined here. There must therefore be a PPP remote site of the same name for the VPN remote site. The user name defined in the PPP table normally differs from the remote site name.
- Server: In the XAUTH server operating mode, the device (after successful negotiation of the initial IKE negotiation) starts authentication with a request to the XAUTH client, which then responds with its user name and password. The XAUTH server searches for the user name in the PPP table and, if a match is found, it checks the password. The user name for this entry in the PPP table is not used.
- Off: No XAUTH authentication is performed for the connection to this remote site.

Default:

- Off



If XAUTH authentication is enabled for a VPN remote site, the IKE-CFG option must be set to the same value.

## 11.11 Backup via alternative VPN connection

### 11.11.1 Introduction

The subject of backup connections is vital to the availability of business-critical applications, especially at distributed sites with several branch offices connected via VPN to the main office. The subject of backups is easy to resolve where routers at the branch offices relate directly to redundant routers at the main office: If a router at the main office can be not reached over the Internet, the branch office simply dials-in to another router at the main office. RIP ensures that the devices can communicate over the available routes.

However, in very large networks branch offices are rarely connected directly to the main office. Instead, several sites initially merge at switching nodes, and these in turn are connected to the main office. If the branch office temporarily loses contact to the switching node, the branch office could establish a direct backup connection to main office.

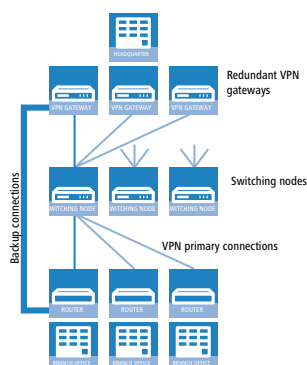

However, this only works via an ISDN connection, often an undesirable solution due to the costs and limited bandwidth. A parallel backup connection directly over VPN does not achieve the objective for the following reasons:

- Only the switching nodes are defined as VPN remote sites in the main office – all routes to the branch offices pass through these switching nodes. If a branch office attempts to establish a direct connection to the main office, the attempt is rejected. And even if this connection were successful, the routes to the branch offices via the switching nodes remain in place at the main office because the switching node is, from the viewpoint of the main office, still accessible.
- The switching node knows nothing about any potential direct connection from branch office to main office. It therefore cannot access the destinations in the network at the branch office by detouring via the main office.
- Both the network of the switching node and the network of the branch office are accessible from the main office via the standard VPN connection. However, a direct VPN connection of the branch office to the main office only provides access to the branch-office network. It is because of these different characteristics that the router at the main office cannot accept the direct connection as a backup for the standard connection.
- The branch office can no longer establish the standard connection to the switching node because the principle of unambiguity in IPsec rules does not permit a second connection with the same set of rules. Along with the specifications on encryption, IPsec rules also contain "network relationships", i.e. the IP addresses of the networks at both ends of the connection. These network relationships may only appear once in the VPN rule set. For a backup, however, two rules would have to exist for the same network relationship – once for the backup connection and once for the newly established primary connection.

### 11.11.2 Backup-capable network infrastructure

In order to also build up an operational backup solution for these applications, the points described in the following sections must be satisfied.

#### Basic prerequisites

The basic prerequisite for the backup function described here are; the configuration of a "Dynamic VPN" connection between branch offices and switching nodes; and the functions "Simplified RAS with certificates" and "Allow remote site to select the remote network" must be enabled in the VPN gateways at the main office.

#### Hierarchy for establishing VPN connections

In order for branch offices to connect to the network at the main office for backup purposes, a defined hierarchy must be observed when establishing the connection. Connections are only established from the "lower" to the "upper" networks, i.e. from the branch office to the switching node, from the switching node to the main office.

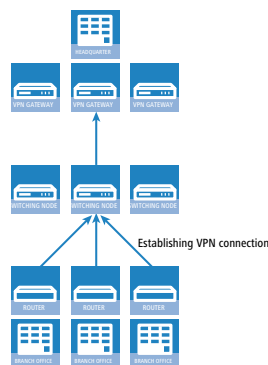

Thus connections only have to be accepted passively at the main office. The switching nodes also accept the branch office connections passively, but establish the connections to the main office actively. This hierarchy is a prerequisite for the later definition of VPN rules.

#### Network definitions

The branch offices establish network relationships with the switching nodes and with the main office - this must be allowed by the appropriate rules. In addition, either all conceivable network relationships must be stored individually or

the networks have to be defined such that all required network relationships can be allowed with a single rule. This is possible if, for example, the IP addresses in the networks have the following structure:

- Central network 10.1.1.0/255.255.255.0
- Switching nodes 10.x.1.0/255.255.255.0
- Branch offices 10.x.y.0/255.255.255.0

Using the following VPN rule in the VPN gateways at the main office permits all required network relationships, i. e. all remote sites from the 10.x... range of addresses can establish connections to all gateways:

- Source 10.0.0.0/255.0.0.0
- Destination 10.0.0.0/255.0.0.0

Because branch offices communicate with the main office via the intermediate level of the switching nodes, corresponding VPN rules must also be created in the switching nodes. If communication with other sub-nodes and branch offices is also to be made possible, all of the required network relationships are permitted with the following VPN rule in the switching nodes:

- Source 10.x.0.0/255.255.0.0
- Destination 10.0.0.0/255.0.0.0

## Routing information

During normal operation, the routes from main office to individual branch offices run via the switching nodes. These routes must be adapted for backup situations. For this adaptation to be performed automatically, "Simplified RAS with certificates" is enabled in the VPN gateways at the main office. This allows a shared configuration to apply for all incoming connections (using default settings) if the certificates of the remote sites have been signed with the root certificate of the VPN gateways in the main office. This also allows remote sites to select the remote network. The routers at the branch offices can then suggest a network (during IKE negotiations in phase 2) to be used for the connection.

 Enabling the two functions "Simplified RAS with certificates" and "Allow remote site to select the remote network" is a necessary condition for the backup function described here.

The routing information at the switching nodes must also be adapted in backup situations. The switching nodes are normally accessed directly from the branch offices. In backup situations, the switching nodes must be able to receive the data from the branch offices via the main office detour. This is made possible with a route that transmits the entire combined network (10.x.0.0/255.255.0.0 in the example or, if communication with other nodes is to be possible: 10.0.0.0/255.0.0.0) to the main office.

In order for the routes to be switched automatically, "Allow remote site to select the remote network" must also be activated at the switching nodes.

This results in the following sequence of events when establishing VPN connections:

- The switching node establishes the connection to the main office and requests all network relationships to the branch offices (i. e. it requests the 10.x.0.0/255.255.0.0 network).
- The branch office establishes the connection to the switching node and requests its network (10.x.y.0/255.255.255.0).

Data can now be transferred from the branch office to the main office via the switching node.

The following happens if the VPN connection between branch office and main office now fails:

- The switching node detects the loss by polling (DPD) and removes the route to the branch office.
- At some point the branch office establishes the backup connection to the main office and requests its network (10.x.y.0/255.255.255.0).

Data can now be transferred from the branch office to the main office.

If the networks have been combined and the switching nodes always route the combined network (as in the example, network 10.x.0.0/255.255.0.0 or 10.0.0.0/255.0.0.0) to the main office, data can be transmitted from the branch office to the switching node via the main office.



Once the backup event is over, the branch office reestablishes the primary connection to the switching node:

- The branch office tears down the backup connection and the main office deletes the route to the branch office.
- The branch office again requests its network (10.x.y.0/255.255.255.0) from the switching node.

Smooth communication between branch office and switching node now exists again.

Because the branch office network is a sub-network of the network in the switching node, immediate communication between branch office and main office via the switching node is also possible again. The main office no longer has its own route to the branch office and therefore resumes transfers data for the branch office via the switching node again.

---

 If network addresses cannot be structured as described above, the route to the branch office must be configured statically at the main office and point to the switching node. If the branch office then establishes the backup connection, the statically registered route is overwritten by the dynamically registered route. If the backup connection is torn down again, the dynamic route is deleted and the static route re-enabled. If, in this case, communication between branch offices and switching node is to be guaranteed for backup as well, the routes to the branch offices must also be configured statically in the switching nodes.

### Establishing a backup connection

In order to conform to the basic principle of unambiguous IPSec rules, backup situations require VPN rules for the primary connection to be deleted first, and then new rules for the backup connection are created.

If the establishment of a backup connection fails, the backup module selects the next backup connection (if several are configured). If the next backup connection uses an ISDN connection, it is established completely normally, i.e. no IPSec rules need be reformulated.

If the backup at the main office is based on ISDN, it is important to avoid coupling the backup connection with the normal VPN connections to the other branch offices. In the event of a backup, these primary VPN connections carry not only the data traffic to the branch offices, but all traffic to the switching nodes and all other branch offices as well. This coupling can be prevented in two ways:

- A very high distance for the branch-office network is entered into the ISDN backup connection. This way the route can be overwritten by the routes automatically communicated via the VPN.
- Alternatively, the routes can be controlled using WAN RIP. For this, an ISDN connection with WAN RIP support is set up for every B-channel.

### Re-establishing the primary connection

The device attempts to restore the primary connection while the backup connection is being established. During this attempt to connect, the VPN rule set must not be recreated again – otherwise the backup connection would fail or an existing VPN connection would simply be torn down.

To prevent this, initial "Dynamic VPN" negotiations with the primary connection's remote site are performed. If these negotiations are successful, the primary connection can be reestablished. To this end, the backup connection is disconnected and the backup status is reset. This prevents the backup connection from being reestablished immediately. Only after this is the primary connection reestablished with the original VPN rules.

---

 The use of the "Dynamic VPN" connection between branch office and switching node is a necessary condition for the backup function described here.

## 11.11.3 Configuring the VPN backup

For configuring the VPN backup, the devices at the branch offices, main office and switching nodes must be considered separately.

- Branch office

- "Dynamic VPN" over ICMP/UDP must be configured for the primary connection.

Connection list - New Entry

Name of connection: SWITCH OK

Short hold time: 30 seconds Cancel

Dead Peer Detection: 0 seconds

Extranet address: 0.0.0.0

Gateway:

Connection parameters:

Rule Creation: Auto

Dynamic VPN connection (only with compatible remote stations):

No dynamic VPN

Dynamic VPN (a connection is created to transmit IP addresses)

Dynamic VPN (IP addresses are transmitted without establishing a connection if possible)

Dynamic VPN (an ICMP packet will be sent to transmit IP addresses)

Dynamic VPN (an UDP packet will be sent to transmit IP addresses)

IKE exchange (only in conjunction with "No dynamic VPN"):

Main mode

Aggressive mode

IKE-CFG: Off

XAUTH: Off

Routing tag: 0

- The backup connection has no requirement for "Dynamic VPN".
- The backup is configured in the backup table, as with ISDN backup.
- At the branch office, the main office must be configured as a backup remote site.
- Main office
  - Simplified RAS with certificates must be enabled.
  - Selection of the remote network by the remote site must be enabled.

- A configuration in the backup table is not necessary here.

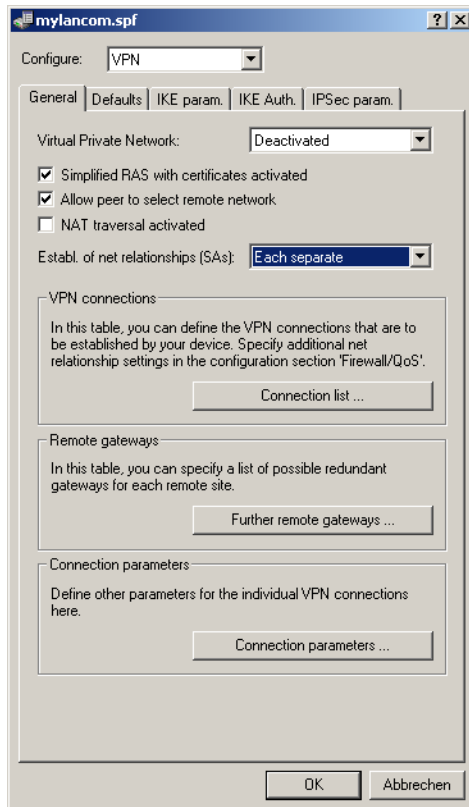

- Switching nodes
  - The VPN connection to the main office must be completely configured.
  - Simplified RAS with certificates must be enabled.
  - Selection of the remote network by the remote site must be enabled.

ⓘ If the system does not have "combined networks" (i.e. the branch office network is a sub-network of the switching node and the switching node network is a sub-network of the central network), then the switching node's route to the branch office must point to the main office in order for the branch office to be able to reach the switching node in backup situations. In normal operation, this route is overwritten by the route passed by the branch office in the VPN (because remote sites may provide network relationships) and is therefore only used when the direct connection is torn down and the branch office establishes the backup connection.

## 11.12 Specific examples of connections

This section covers the 4 possible types of VPN connections with concrete examples. These 4 different connection types are categorized by the type of IP address of the two VPN gateways:

- static/dynamic
- dynamic/static (the dynamic peer initiates the connection)
- static/dynamic (the static peer initiates the connection)
- dynamic/dynamic

There is a section for each of these types, together with a description of all required configuration information in the familiar table form.

### 11.12.1 Static/static

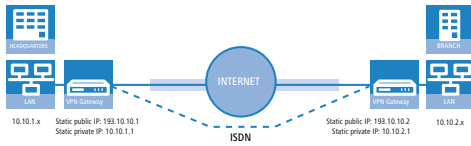

A VPN tunnel via the Internet serves as the connection between the LANCOM **Headquarters** and **branch office**. Both gateways have static IP addresses. Thus, both can initiate the connection.

Entry	Headquarters		Branch_office
Type of local IP address	static	↔	static
Type of remote IP address	static		static
Name of the local device	Headquarters	↔	Branch_office
Name of the remote device	Branch_office		Headquarters
Shared Secret for encryption	secret	↔	secret
IP address of the remote device	193.10.10.2		193.10.10.1
IP-network address of the remote network	10.10.2.0		10.10.1.0
Netmask of the remote network	255.255.255.0		255.255.255.0

### 11.12.2 Dynamic/static

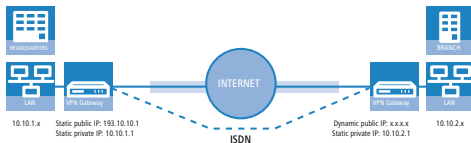

The VPN gateway **Branch office** initiates a VPN connection to the gateway **Headquarters**. **Branch office** has a dynamic IP address that was chosen and assigned by the Internet service provider upon dialling in, whereas **Headquarters** has a fixed, static address. When the connection is set up, **Branch office** transmits its actual IP address to **Headquarters**. This is accomplished by a special ICMP packet (alternatively UDP, port 87).

Entry	Headquarters		Branch_office
Type of local IP address	static	↔	dynamic
Type of remote IP address	dynamic		static
Name of the local device	Headquarters	↔	Branch_office
Name of the remote device	Branch_office		Headquarters
Password for the secure transmission of the IP address	confidential	↔	confidential
Shared Secret for encryption	secret	↔	secret
IP address of the remote device	–		193.10.10.1
IP-network address of the remote network	10.10.2.0		10.10.1.0
Netmask of the remote network	255.255.255.0		255.255.255.0

⚠ An ISDN line is not necessary for establishing this type of connection. The dynamic end communicates its IP address encrypted via the Internet protocol ICMP (or alternatively via UDP).

### 11.12.3 Static/dynamic (with LANCOM Dynamic VPN)

In this case (other than the example above), the peer with the static IP address initiates the VPN connection.

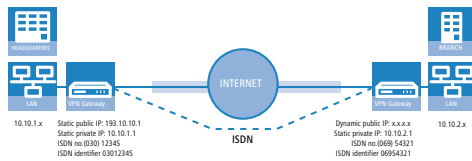

The VPN gateway **Headquarters** initiates a VPN connection to **Branch office**. **Headquarters** has a static IP address, **Branch office** a dynamic one.

! The entries for the ISDN connection are needed for the transmission of the actual dynamic IP address solely. The Internet access wizard configures the connection to the Internet.

! Alternatively, this application can be solved with the help of dynamic DNS. In this constellation, the headquarters with its static IP address connects to the branch office with the help of a dynamic DNS name which is assigned to the current dynamic IP address. More information is available under .

Entry	Headquarters		Branch_office
Type of local IP address	static	↔	dynamic
Type of remote IP address	dynamic		static
Name of the local device	Headquarters	↔	Branch_office
Name of the remote device	Branch_office		Headquarters
ISDN-calling number of the remote device	06954321		03012345
ISDN-caller ID of the remote device	06954321		03012345
Password for the secure transmission of the IP address	confidential	↔	confidential
Shared Secret for encryption	secret	↔	secret
IP address of the remote device			193.10.10.1
IP-network address of the remote network	10.10.2.0		10.10.1.0
Netmask of the remote network	255.255.255.0		255.255.255.0

! The described connection set up requires an ISDN connection for both VPN gateways.

### 11.12.4 Dynamic/dynamic (with LANCOM Dynamic VPN)

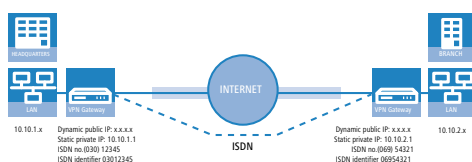

A VPN tunnel via the Internet serves as the connection between the LANCOM **Headquarters** and **branch office**. Both sites have dynamic IP addresses. Thus, both can initiate the connection.

! The entries for the ISDN connection are needed for the transmission of the actual dynamic IP address solely. The Internet access wizard configures the connection to the Internet.

! Alternatively, this application can be solved with the help of dynamic DNS. Instead of a static IP address, a dynamic DNS name helps to find the dynamic IP address that is currently in use. More information is available under .

Entry	Headquarters		Branch_office
Type of local IP address	dynamic	↔	dynamic
Type of remote IP address	dynamic		dynamic
Name of the local device	Headquarters	↔	Branch_office
Name of the remote device	Branch_office		Headquarters
ISDN-calling number of the remote device	06954321		03012345
ISDN-caller ID of the remote device	06954321		03012345
Password for the secure transmission of the IP address	confidential	↔	confidential
Shared Secret for encryption	secret	↔	secret
IP-network address of the remote network	10.10.2.0		10.10.1.0
Netmask of the remote network	255.255.255.0		255.255.255.0

! Dynamic VPN works only between LANCOM that each feature at least one ISDN port that can be used for the ISDN connection

### 11.12.5 VPN connections: High availability with VPN load balancing

#### Multiple VPN gateway addresses

In decentralized company structures that rely on VPN for networking the various locations, the availability of the central VPN gateway is of particular significance. The company-wide communications only remain reliable as long as these central dial-in nodes are working properly.

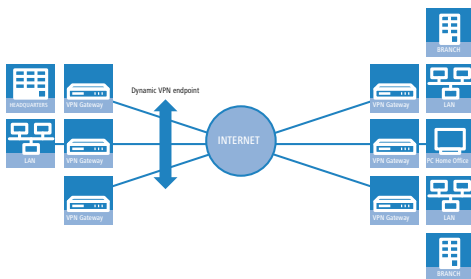

With the option of configuring several "remote gateway" addresses as "dynamic VPN endpoints" for a VPN connection, LANCOM VPN gateways offer a high level of availability by using redundant devices. This involves multiple gateways at the headquarters being set up with identical VPN configurations. On location at the satellite sites, all of these available gateways are entered as possible remote stations for the VPN connection. If one of the gateways is unavailable, the remote router automatically redirects the request to one of the other routers.

To ensure that the computers in the LAN at the headquarters know which VPN gateway it to be used to reach a particular satellite station, the outband router currently connected to the remote site is propagated via RIPv2 to the network at the headquarters.

! A powerful mechanism for high availability with constant load balancing between the VPN gateways at the headquarters is attained with the configuration of the satellite stations to select the remote site for VPN connection on a random basis.

## Configuration

During configuration, additional destinations for a VPN connection should be entered in the list of "Remote gateways". The list consists of the following entries:

- Name: Name of the remote site from the VPN connection list, the "target" of the VPN connection.
- Gateway 2 to Gateway 9: Address of the alternative gateways, as an IP address or DNS-translatable address.
- Begin with: In which order should the entries are to be tried. You can select from:
  - Last used: Selects the entry for the VPN connection which was successfully used most recently.
  - First: Selects the first of the configured remote stations.
  - Random: Selects one of the configured remote stations at random. This setting provides an effective measure for load balancing between the gateways at the headquarters.

! The entry for the gateway in the VPN connection list can be left blank if all of the possible gateways are entered into the list of "Remote gateways".

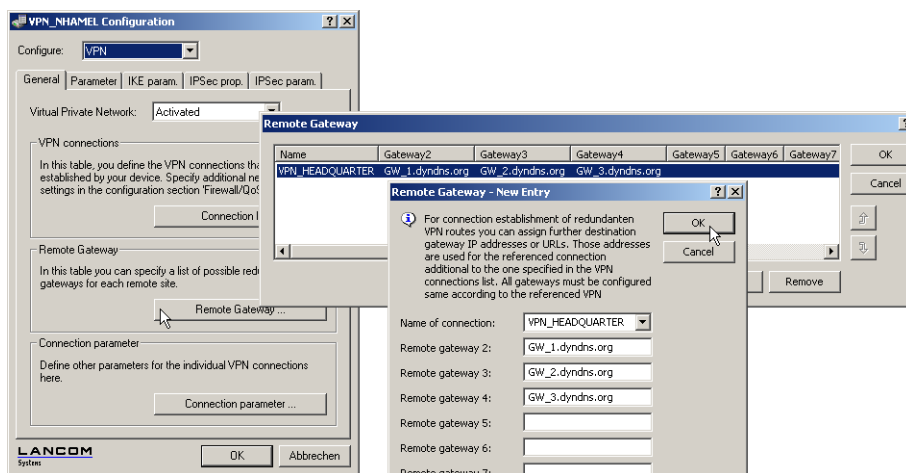

LANconfig: VPN / General / Remote gateway

WEBconfig: LCOS menu tree / Setup / Config E Remote-gateway-list

The following options are available for defining the strategy for the utilization of the configured remote-gateway addresses:

- last used
- first
- random

Example:

The following command sets three gateways as target at the headquarters, one of which is to be selected at random:

```
set VPN_HEADQUARTERS 213.217.69.75 213.217.69.76 213.217.69.77 * * * *
* random
```

## 11.13 How does VPN work?

In practice, a VPN must fulfill a number of requirements:

- Unauthorized third parties must not be able to read the data (encryption)
- It should not be possible to manipulate the data (data integrity)
- Unambiguous identification of the sender of data (authentication)

- Simple key management
- Compatibility to VPN devices from a variety of manufacturers

LANCOM VPN achieves these five major goals by applying the widely used IPSec standard.

### 11.13.1 IPSec—The basis for LANCOM VPN

The original IP protocol does not contain any provisions for security. Security problems are compounded by the fact that IP packets do not go directly to a specific recipient, but are sent scattershot to all computers on a given network segment. Anyone can help themselves and read the packets. This leaves the door open to the misuse of data.

IP has been developed further for this reason. A secure version is now available: IPSec. LANCOM VPN is based on IPSec.

IPSec stands for “**IP**Security Protocol” and was originally the name used by a working group of the IETF, the **I**nternet **E**ngineering **T**ask **F**orce. Over the years, this group has developed a framework for a secure IP protocol that is generally referred to as IPSec today.

It is important to note that IPSec itself is not a protocol, but merely the standard for a protocol framework. IPSec actually consists of a variety of protocols and algorithms for encryption, authentication and key management. These standards will be introduced in the following sections.

#### Security in an IP environment

IPSec has been implemented almost completely within level 3 of the OSI model, i.e. in the network layer. The transfer of data packets using the IP protocol is realized on level 3 of IP networks.

IPSec thus replaces the IP protocol. Under IPSec, the packets have a different internal structure than IP packets. Their external structure remains fully compatible to IP, however. IPSec packets can therefore be transported without problems by existing IP networks. The devices in the network responsible for the transport of the packets cannot distinguish IPSec packets from IP packets on the basis of their exterior structure.

The exceptions in this case are certain firewalls and proxy servers that access the contents of the packets. Problems can arise from the (often function dependent) incompatibilities of these devices to the existing IP standard. These devices must therefore be adapted to IPSec.

IPSec will be firmly implemented in the next generation of the IP standard (IPv6). For this reason, we can assume that IPSec will remain the most important standard for virtual private networks in the future.

### 11.13.2 Alternatives to IPSec

IPSec is an open standard. It is not dependent on individual manufacturers and is being developed by the IETF with input from the interested public. The IETF is a nonprofit organization that is open to everyone. The broad acceptance of IPSec is the result of this open structure which unites a variety of technical approaches.

Nevertheless, there are other approaches for the realization of VPNs. We will only mention the two most important of these here. They are not realized at the network level like IPSec, but at the connection and application levels.

#### Security at the connection level – PPTP, L2F, L2TP

Tunnels can already be set up at the connection level (level 2 of the OSI model). Microsoft and Ascend developed the **P**oint-to-**P**oint **T**unneling **P**rotocol (PPTP) early on. Cisco presented a similar protocol with **L**ayer **2**Forwarding (L2F). Both manufacturers agreed on a joint effort and the IETF produced the **L**ayer **2**Tunnel **P**rotocol (L2TP).

Their main advantage over IPSec is that any network protocol can be used with such a network connection, especially NetBEUI and IPX.

A major disadvantage of the described protocols is the lack of security at the packet level. What's more, these protocols were designed specifically for dial-up connections.



## Security at higher levels – SSL, S/MIME, PGP

Communications can also be secured with encryption at higher levels of the OSI model. Well known examples of this type of protocol are SSL (**S**ecure **S**ocket **L**ayer) mainly used for web browser connections, S/MIME (**S**ecure **M**ultipurpose **I**nternet **M**ail **E**xtensions) for e-mails and PGP (**P**retty **G**ood **P**rivacy) for e-mails and files.

In all of the above protocols, an application handles the encryption of the data, for example the Web browser on one end and the HTTP server on the other.

A disadvantage of these protocols is the limitation to specific applications. In addition, a variety of keys is generally required for the different applications. The configuration must be managed on the individual computers and can not be administered conveniently on the gateways only, as is the case with IPSec. Security protocols at the application level tend to be more intelligent as they know the significance of the data being transferred. They are usually much more complex, however.

All of these layer-2 protocols only support end-to-end connections; they are therefore not suitable for coupling entire networks.

On the other hand, these mechanisms do not require the slightest changes to the network devices or access software. And unlike protocols in lower network levels, they are still effective when the data content is already in the computer.

## Combinations are possible

All of the alternatives listed above are compatible to IPSec and can therefore be used parallel to it. This permits a further increase of the security level. It would be possible, for example, to dial into the Internet using an L2TP connection, set up an IPSec tunnel to a Web server and exchange HTTP data between the Web server and the browser in secure SSL mode.

Each additional encryption would reduce the data throughput, however. Users can decide on a case-by-case basis whether the security offered by IPSec alone is sufficient. Only in rare cases is a higher level of security really necessary. Particularly as the degree of security can be adjusted within IPSec.

## 11.14 The standards behind IPSec

IPSec is based on a variety of protocols for the individual functions. These protocols are based on, and complement one another. The modularity achieved with this concept is an important advantage of IPSec over other standards. IPSec is not restricted to specific protocols but can be supplemented at any time by future developments. The protocols integrated to date also offer such a high degree of flexibility that IPSec can be perfectly adapted to virtually any requirements.

### 11.14.1 IPSec modules and their tasks

IPSec has to perform a number of tasks. One or more protocols have been defined for each of these tasks.

- Authentication of packets
- Encryption of packets
- Transfer and management of keys

### 11.14.2 Security Associations – numbered tunnels

A logical connection (tunnel) between two IPSec devices is known as an SA (**S**ecurity **A**ssociation). SAs are managed independently by the IPSec device. An SA consists of three values:

- Security Parameter Index (SPI)
  - ID to distinguish multiple logical connections to the same target device with the same protocols
- Target IP address
- Security protocol used

Designates the security protocol used for the connection: AH or ESP (further information will be provided on these protocols in the following sections).

An SA applies only to one communication direction of the connection (simplex). A complete send and receive connection requires two SAs. In addition, an SA only applies for one used protocol. Two separate SAs are also required if AH and ESP are used, i.e. two for each communication direction.

The SAs are managed in an internal database of the IPSec device that also contains the advanced connection parameters. These parameters include the algorithms and keys used, for example.

### 11.14.3 Encryption of the packets – the ESP protocol

The ESP protocol (**Encapsulating Security Payload**) encrypts the packets as protection against unauthorized access. This was once the only function of ESP, but in the course of the further development of the protocol it was expanded with options for the protection of integrity and verification of authenticity. In addition, ESP also features effective protection against replayed packets. ESP thus offers all of the functions of AH – in some cases, however, the use of AH parallel to ESP is advisable.

#### How ESP works

The structure of ESP is more complex than that of AH. ESP also inserts a header behind the IP header as well its own trailer and a block of ESP authentication data.

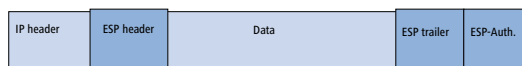

#### Transport and tunnel mode

Like AH, ESP can be used in two modes: transport and tunnel mode.

In transport mode, the IP header of the original packet is left unchanged and the ESP header, encrypted data and both trailers are inserted.

The IP header contains the unchanged IP address. Transport mode can therefore only be used between two end points, for the remote configuration of a router, for example. It cannot be used for the coupling of networks via the Internet – this would require a new IP header with the public IP address of the recipient. In such cases, ESP can be used in tunnel mode.

In tunnel mode, the entire packet including the original IP header is encrypted and authenticated and the ESP header and trailers are added at the entrance of the tunnel. A new IP header is added to this new packet, this time with the public IP address of the recipient at the end of the tunnel.

#### Encryption algorithms

As a higher-level protocol, IPSec does not require specific encryption algorithms. The manufacturers of IPSec products are thus free in their choice of the processes used. The following standards are common:

- **AES** – Advanced Encryption Standard AES is the official encryption standard for use by US authorities, and therefore one of the most important standards worldwide. Following a worldwide competition in the year 2000 to find the best of the numerous encryption algorithms, the **National Institute of Standards and Technology (NIST)** selected the Rijndael algorithm (pronounced: "Rinedoll") and declared it as the AES in 2001.

AES is a symmetric key algorithm with variable block and encryption lengths. It has been developed by the Belgian scientists Joan Daemen and Vincent Rijmen, and features outstanding security, flexibility and efficiency.

- **DES** – Data Encryption Standard DES was developed by IBM for the NSA (National Security Agency) in the early 1970s and was the worldwide security standard for years. The key length of this symmetrical process is 56 bits. Today, it is considered to be insecure due to its short key length and in the year 2000 the NIST replaced it with the AES (Rijndael algorithm). It is no longer suitable for use.

- Triple DES (a.k.a. 3-DES) A further development of DES. The conventional DES algorithm is applied three times consecutively. Two or three different keys, each with a length of 56 bits are used. The key for the first run is reused for the third DES run. The result is a nominal key length of 168 bit, with an effective key length of 112 bits.

Triple-DES combines the sophisticated DES technology with a sufficiently long key and is therefore considered to be highly secure. Triple-DES is slower than other processes, however.

- Blowfish This development by the renowned cryptographer Bruce Schneier is a symmetrical encryption process. Blowfish achieves outstanding data throughput on multifunction processors. The process is reputed to be extremely efficient and secure.
- CAST (from the authors **Carlisle Adams** and **Stafford Tavares**) is a symmetrical process with a key length of 128 bits. CAST permits the modification of parts of the algorithm at runtime.

⚠ The encryption settings can be modified in the LCOS menu tree within LANconfig. Modifications of this sort are generally only required when setting up VPN connections between devices from different manufacturers. LANCOM gateways offer the encryption as standard either after AES (128 bit), Blowfish (128 bit) or Triple-DES (168 bit).

### 11.14.4 Authentication – the AH protocol

The AH protocol (**A**uthentication **H**eder) guarantees the integrity and authenticity of the data. Integrity is frequently regarded as a component of authenticity. In the following, we will consider integrity to be a separate problem that is resolved by AH. In addition to integrity and authenticity, AH also provides effective protection against the replay of received packets (Replay Protection).

AH adds its own header to IP packets immediately after the original IP header. The most important part of this AH header is a field containing authentication data, often referred to as the **I**ntegrity **C**heck **V**alue (ICV).

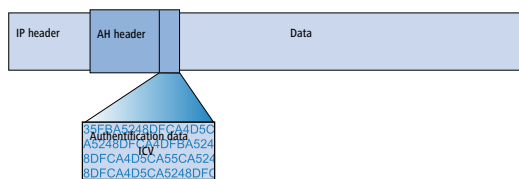

#### The AH process in the sender

In the sender, the authentication data is generated in 3 steps.

1. A checksum is calculated for the complete package using a hash algorithm.
2. This checksum is once again sent through a hash algorithm together with a key known to both the sender and the recipient.
3. This results in the required authentication data which is inserted in the AH header.

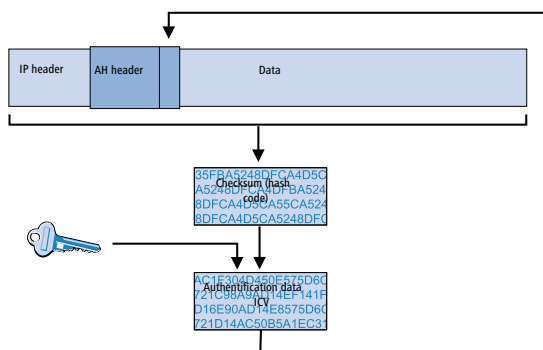

## Checking of integrity and authenticity by the recipient

The AH protocol works in a very similar manner at the recipient's end. The recipient also uses his key to calculate the authentication data for the received packet. The comparison with the sent ICV of the packet determines the integrity and authenticity of the packet.

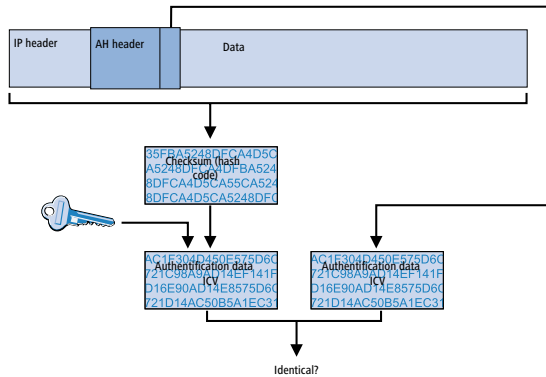

## Determining the checksum for the integrity check

AH adds a checksum to each packet before it is sent to guarantee the integrity of the transferred packets. At the recipients end, AH checks whether the checksum and the contents of the package match. If this is not the case, the packet was either incorrectly transferred or deliberately manipulated. Such packets are discarded immediately and are not forwarded to higher protocol levels.

A variety of so-called hash algorithms are available to determine the checksum. Hash algorithms are distinguished by the fact that their results (the hash code) are a unique fingerprint of the original data. Conversely, the original data cannot be determined on the basis of the hash code. In addition, minimum changes of the input value entail a completely different hash code with a high-grade hash algorithm. Systematic analyses of several hash codes thus are made more difficult.

LANCOM VPN supports the two most common hash algorithms: MD5 and SHA-1. Both methods work without keys, i.e. on the basis of fixed algorithms. Keys do not play a role until a later step of AH: the final generation of the authentication data. The integrity checksum is only a necessary intermediate result on the way there.

## Generation of the authentication data

In the second step, AH generates a new hash code using the checksum and a key, the final authentication data. A variety of standards are available under IPSec for this process as well. LANCOM VPN supports HMAC (**H**ash-based **M**essage **A**uthentication **C**ode). The hash functions MD5 and SHA-1 are available as hash algorithms. The HMAC versions are accordingly known as HMAC-MD5-96 and HMAC-SHA-1-96.

This clarifies why AH leaves the packet itself unencrypted. Only the checksum of the packet and the local key are added to the packet together with the ICV, the authentication data, in encrypted form as a verification criterion.

## Replay protection – protection against replayed packets

In addition to the ICV, AH assigns a unique sequence number to each packet. The recipient can thus recognize which packets were intercepted by a third party and resent. Attacks of this type are known as “packet replay”.

**!** AH does not cater for the masking of IPSec tunnels unless additional measures, such as NAT-Traversal or an outer Layer-2-Tunneling (e.g. PPPT/L2TP), are used that offer “changeable” IP headers.

## 11.14.5 Key management – IKE

The Internet **K**ey Exchange Protocol (IKE) permits the integration of subprotocols for managing the SAs and for key administration.

Within IKE, two subprotocols are used in LANCOM VPN: Oakley for the authentication of partners and key administration, and ISAKMP for managing the SAs.

### Setting up the SAs with ISAKMP/Oakley

Establishing an SA involves a sequence of steps (with dynamic Internet connections, these steps follow the exchange of the public IP addresses):

1. The initiator sends a plain-text message to the remote station via ISAKMP with the request to set up an SA and with proposals for the security parameters of the SA.
2. The remote station replies with the acceptance of a proposal.
3. Both devices now generate key pairs, each consisting of a public and private key, for Diffie-Hellman encryption.
4. In two further messages, the devices exchange their public keys for Diffie-Hellman. The further communication is encrypted with Diffie-Hellman.
5. Both ends use numbers that have been transferred (with the Diffie-Hellman method) and the Shared Secret to generate a common secret key that is used to encrypt the subsequent communication. Both sides additionally authenticate their Shared Secrets by using hash codes. Phase 1 of the SA setup is thus completed.
6. Phase 2 is based on the encrypted and authenticated connection established in Phase 1. In Phase 2, the session keys for the authentication and symmetrical encryption of the actual data transfer are generated at random and transferred.

 Symmetrical processes are used for the encryption of the actual data transfer. Asymmetrical processes (also known as public-key encryption) are more secure as they do not require the exchange of secret keys. However, they require considerable processing resources and are thus significantly slower than symmetrical processes. In practice, public-key encryption is generally only used for the exchange of key material. The actual data encryption is then performed using the fast symmetrical process.

### The regular exchange of new keys

ISAKMP ensures that new key material is regularly exchanged between the two devices during the SA. This takes place automatically and can be checked using the 'Lifetime' setting in the advanced configuration of LANconfig.

## 11.15 Addition(s) to LCOS 8.00

### 11.15.1 VPN Pathfinder

#### Introduction

In some environments it is impossible to establish a secured VPN connection over an existing Internet connection due to an interim firewall that blocks the ports used by IPsec. To be able to set up an IPsec-secured VPN connection in such a situation, LANCOM VPN routers support the technology known as VPN Pathfinder.

The first attempt always tries to establish data communications with standard IPsec. If the connection cannot be established (e.g. because IKE port 500 is blocked by a cellular network), then an attempt is then automatically made to establish a connection that encapsulates the IPsec VPN in an additional SSL header (port 443, like https).

Note that VPN Pathfinder technology only works when both ends of the connection support this function and that the corresponding options have been activated. VPN Pathfinder is available in LANCOM VPN routers with LCOS 8.0 or higher, and with the LANCOM Advanced VPN Client 2.22 or higher.

#### Configuring VPN Pathfinder technology

For the active establishment of a connection from one LANCOM VPN device to another VPN remote by using VPN Pathfinder technology, activate the option in the VPN name-list entry that corresponds to the remote site.

- LANconfig: VPN / General / Connection list
- WEBconfig: LCOS menu tree / Setup / VPN / VPN remote sites

Connection list - Edit Entry

Name of connection: CLIENT\_0001

Short hold time: 0 seconds

Dead Peer Detection: 60 seconds

Extranet address: 0.0.0.0

Gateway: 0.0.0.0

Connection parameters: P-CLIENT\_0001

Rule Creation: Manual

Dynamic VPN connection (only with compatible remote stations):

- No dynamic VPN
- Dynamic VPN (a connection is created to transmit IP addresses)
- Dynamic VPN (IP addresses are transmitted without establishing a connection if possible)
- Dynamic VPN (an ICMP packet will be sent to transmit IP addresses)
- Dynamic VPN (an UDP packet will be sent to transmit IP addresses)

IKE exchange (only in conjunction with "No dynamic VPN"):

- Main mode
- Aggressive mode

IKE-CFG: Server

XAUTH: Off

SSL-IPsec (Pathfinder): On

Routing tag: 0

- SSL-IPsec (Pathfinder)

With this option you activate VPN Pathfinder technology when actively establishing a connection to this remote site.

Possible values:

- On, off

Default:

- Off



Note that when the VPN Pathfinder option is activated, the VPN connection can only be established when the remote site also supports this technology, and when the remote site is set up to receive passive VPN connections that use VPN Pathfinder.

Activate the option in the general VPN settings to enable passive connection establishment to a LANCOM VPN device from another VPN remote that works with VPN Pathfinder technology (LANCOM VPN device or LANCOM Advanced VPN client).

- LANconfig: VPN / General

- WEBconfig: LCOS menu tree / Setup / VPN

- Accept SSL-IPsec (VPN Pathfinder)

With this option your system accepts passive attempts to connect when the remote site supports VPN Pathfinder technology.

Possible values:

- On, off

Default:

- Off



The LANCOM Advanced VPN Client supports automatic fallback to VPN Pathfinder. With this setting, the VPN client initially attempts to establish a connection **without** using the additional SSL encapsulation. If the connection cannot be made, the device then tries to connect **with** the additional SSL encapsulation.

## Status displays for VPN Pathfinder technology

The status displays show whether VPN-Pathfinder technology is being used on each of the active VPN connections.

- WEBconfig: LCOS menu tree / Setup / VPN / Connections

Connections																		
Peer	State	Last-Error	Mode	SH-Time	phys.-Conn.	B1-DT	Remote-Gw	Nat-Detection	SSL-Encaps.	Crypt-Alg	Crypt-Length	Hash-Alg	Hash-Length	Hmac-Alg	Hmac-Length	Compr-Alg	Client-SN	Conn-time
CLIENT	Ready	(none)	Active	0	NETCOLOGN	9999	0.0.0.0	no-nat	No	(none)	0	(none)	0	(none)	0	(none)	not-available	0:00:01
LCS	Connection	(none)	Active	9999	NETCOLOGN	9999	213.217.69.77	no-nat	No	AES	128	HMAC_MD5	128	(none)	0	(none)	not-available	3:10:19

## 11.16 Addition(s) to LCOS 8.60

### 11.16.1 Improved phase 1 rekeying

Throughout the operation of an active VPN connection, the stations constantly check whether communications are subject to a previously agreed security association (SA). If the framework conditions change (e. g. a change of the client's IP address through relocation to a different radio cell), you must renegotiate this security association. This is done with "rekeying".

As of version 2.30, the LANCOM Advanced VPN Client transmits a special identification number (ID) during phase 1 rekeying. A LANCOM VPN gateway detects rekeying based on this ID and links the previous security association with the client. This makes re-authentication unnecessary.

### 11.16.2 MPPE encryption for PPTP tunnels

The encryption protocol MPPE (Microsoft Point-To-Point Encryption) secures data transmission over PPP and VPN connections with key lengths of up to 128 bit.

MPPE uses the "stateless mode" for encryption to ensure that both communication partners are synchronized. In this mode, the session key changes with each transmitted data packet. The two stations also synchronize their encryption tables (where the keys are stored for data encryption) each time.

VPN-capable devices from LANCOM use MPPE to encrypt data transfer by PPTP tunnel.

In LANconfig you find this setting under **Communication > Protocols > PPTP list**

If you have enabled the MPPE encryption protocol, connections to clients are established only under the following conditions:

- The client establishes a connection secured with MPPE. The router rejects the request for other protocols.
- The client uses as a minimum the key length specified in the router. With shorter key lengths the router refuses to connect and, with stronger encryption, the router switches to the appropriate key length.

#### Additions to the menu system

##### Encryption

Enter the key length here.

##### SNMP ID:

2.2.21.7

##### Telnet path:

**Setup > WAN > PPTP-peers**

##### Possible values:

Off

40 bit

56 bit

128 bit

##### Default:

Off



## 11.17 Addition(s) to LCOS 8.62

### 11.17.1 Default proposals for IKE and IPSec

The proposals for IKE and IPSec all now support a key length of 256 bits in the default settings.

- ! A firmware upgrade initially does not enable this change, to avoid any problems for existing installations. To accept the changes, you must perform a reset of the device or reset the tables. For new devices with LCOS 8.62 or later, the new defaults are already active.

### 11.17.2 myVPN

The LANCOM myVPN app offers you a very easy way to set up a VPN connection to your company network from your iPhone, iPad or iPod (or from any iOS device in general). The LANCOM myVPN app offers the following functions:

- Highly secure, mobile VPN connections made easy
- Facilitates the complex VPN configuration of the integrated VPN client of iOS devices and the LANCOM router
- PIN operation for the authentication during the VPN tunnel establishment
- Access control via adjustable firewall rules on LANCOM VPN gateways
- LANCOM myVPN user management and automatic detection of myVPN-activated LANCOM gateways
- For version 4.1 iOS devices and later

After its installation, the LANCOM myVPN app retrieves a VPN profile from your LANCOM VPN device and automatically configures all of the necessary settings on the iOS device. You can then use the internal features of iOS to establish a VPN connection to your company network in just a few steps.

#### Using the Setup Wizard in LANconfig to set up a VPN profile for the LANCOM myVPN app

This is how to use the Setup Wizard to provide an access account for a VPN client on an iOS device:

1. Start LANconfig, for example from the Windows start menu with **Start > Programs > LANCOM > LANconfig**. LANconfig now automatically searches the local network for devices.
2. Choose the required device from the selection window in LANconfig and select the **Setup Wizard** button or use the menu under **Tools > Setup Wizard**.
3. Select the item **Provide remote access (RAS, VPN)** and then click on **Next**.

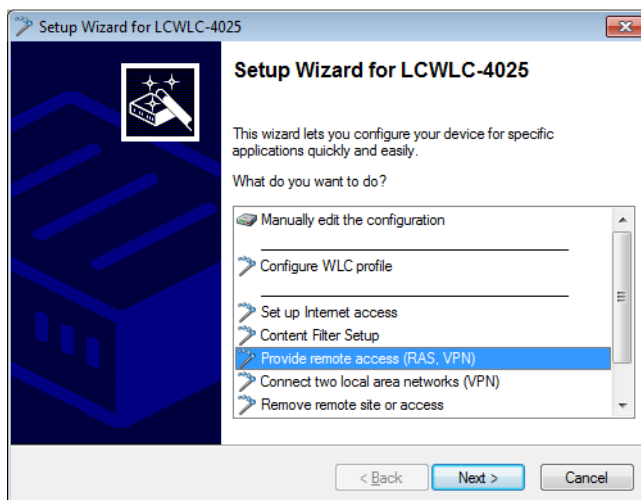

You can skip the following information dialog with **Next**.

- From the drop-down list select the option **LANCOM myVPN client** and click on **Next**.

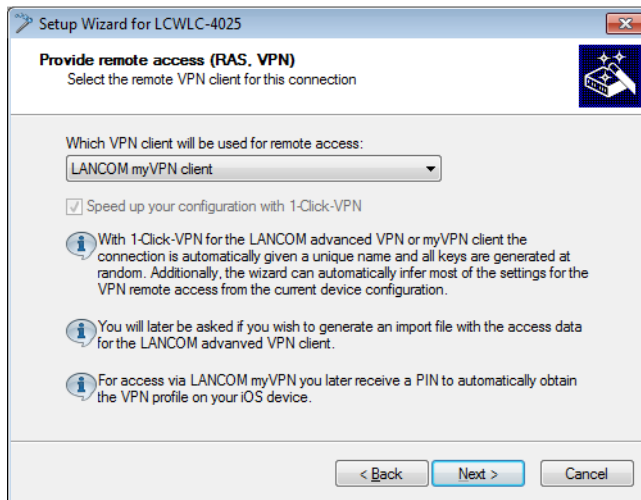

- Enter a name for this access account and select the address at which the VPN client on the iOS device can reach the router from the Internet. To continue, click on **Next**.

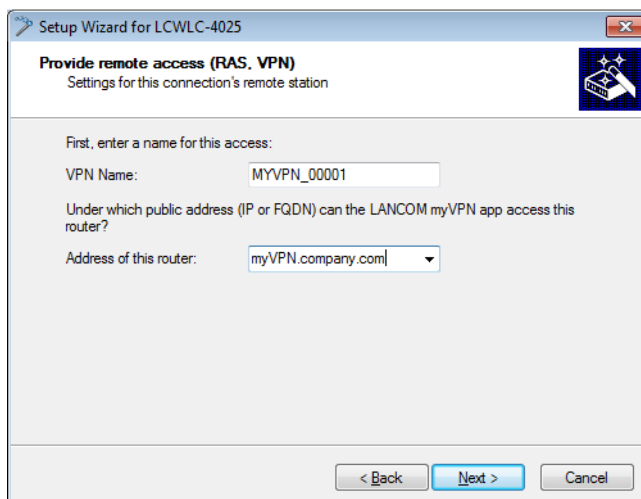

The Setup Wizard will suggest a name that you can accept if you wish.

6. If the VPN device doesn't have a pool of IP addresses configured already, the following dialog will prompt you to specify a unique range of IP addresses as a pool. During dial-in the VPN device will assign a free IP address from this pool to the iOS device.

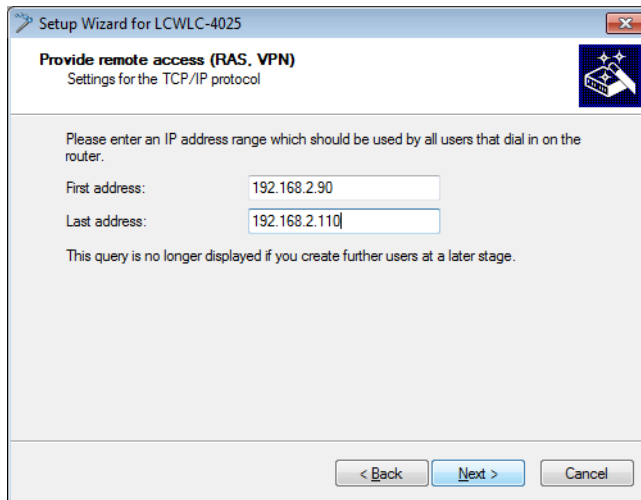

- ! If the VPN device already has configured a pool of IP addresses for VPN clients, it will automatically use this address pool and skip the dialog shown above.

7. The Setup Wizard displays the profile name and the PIN that was auto-generated for the VPN client. If you want to print out the PIN now, select the option **Print PIN now**. Click on **Next**.

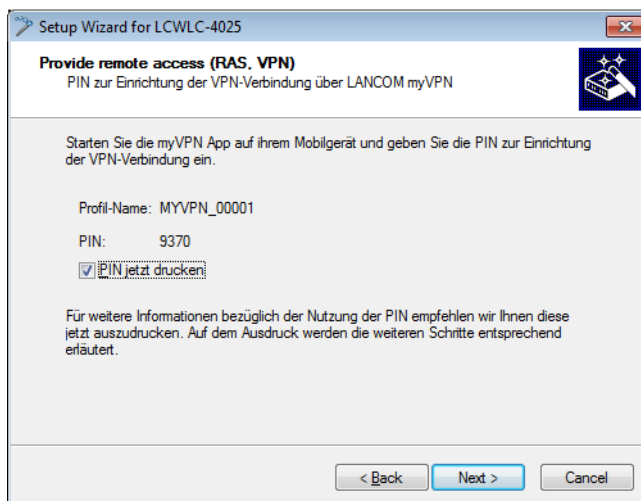

8. By clicking on **Finish** the Setup Wizard stores all the settings on the corresponding VPN device. If applicable, it then starts with the printout of the myVPN PIN. The myVPN module is now enabled on the selected VPN device. On your iOS device, you can now start the myVPN app and enter the PIN to retrieve the VPN profile.

### Retrieve the VPN profile with the LANCOM myVPN app

This is how you can use the LANCOM myVPN app on your iOS device to retrieve a VPN profile from a LANCOM VPN device:

- ! The purpose of the LANCOM myVPN app is to set up the VPN client on iOS devices with the correct parameters and in a quick and easy way. The establishment of the VPN connection to the company network itself is handled directly by the VPN client in the iOS device.

1. Download the LANCOM myVPN app from the Apple App Store.
2. Open the app on your iPhone or iPad.

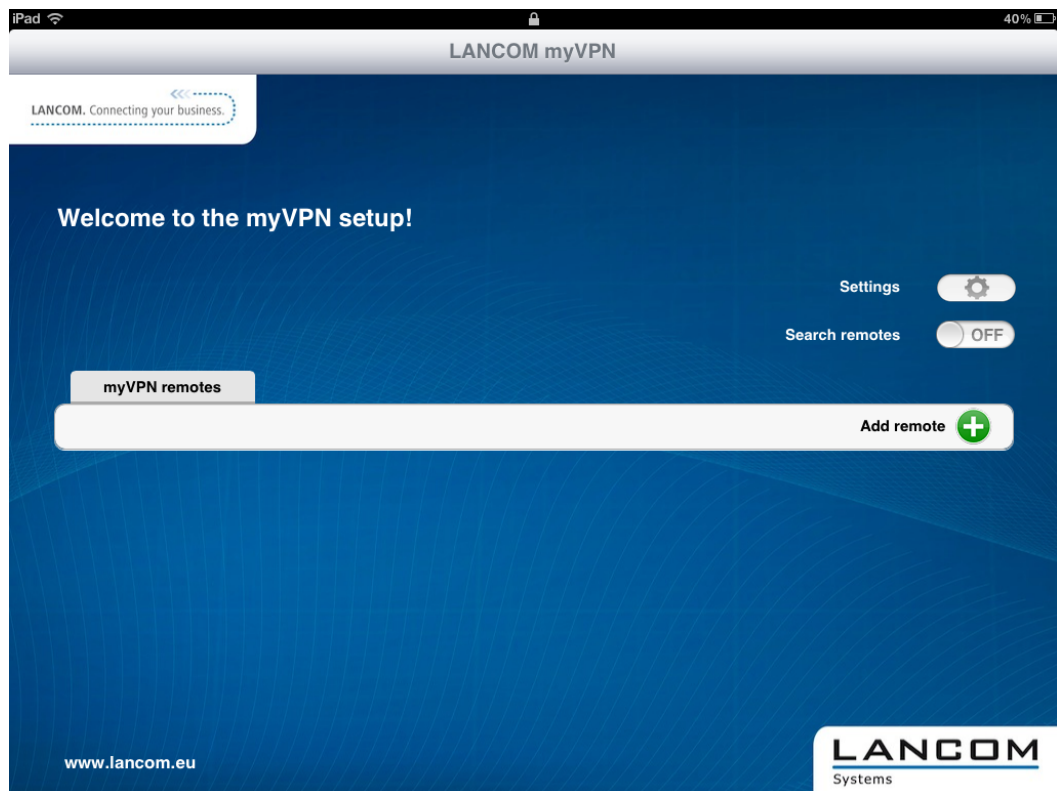

- Optional: Enable the option **Search remotes** to find VPN devices with an activated LANCOM myVPN module and which is available to iOS devices via WLAN.

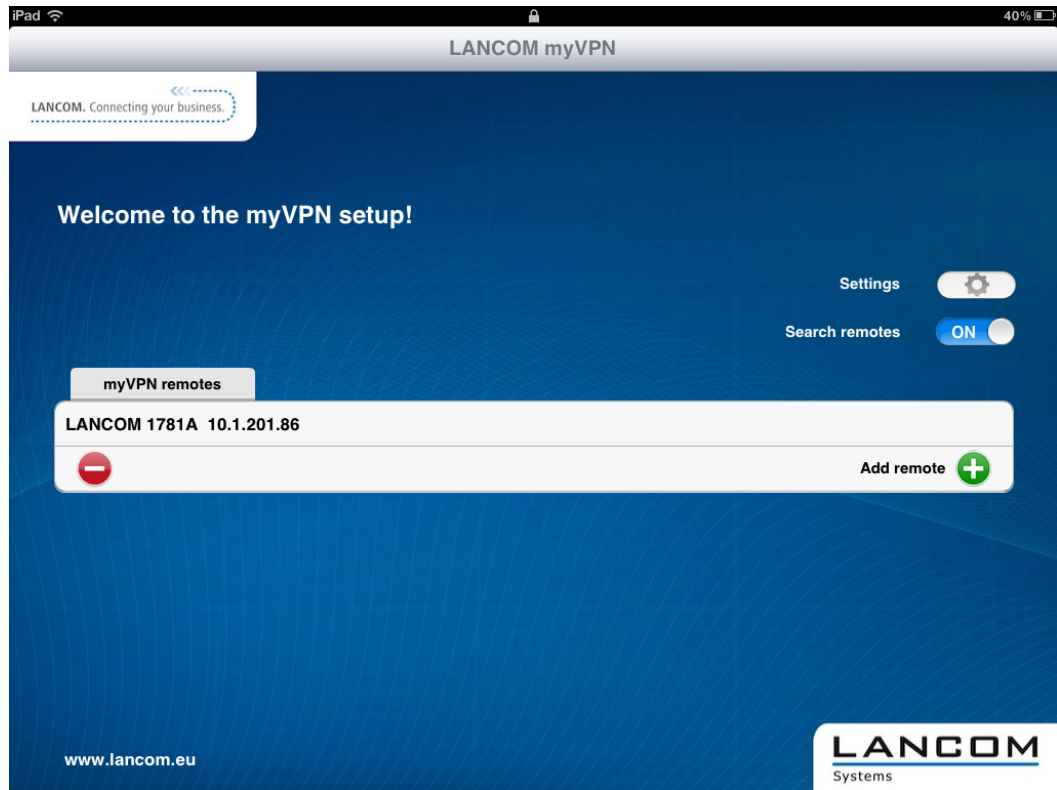

- ! The iOS device now lists all VPN devices which are accessible via WLAN and which have an active LANCOM myVPN module. However, the inclusion of an entry in this list does not necessarily mean that your iOS device can retrieve a LANCOM myVPN profile from this VPN device.

- Optional: Select the option **Add device manually** to enter the IP address or name of VPN devices that the iOS device can access via an Internet connection (3G or WLAN). In the dialog that follows, enter the IP address or the name of the VPN device and confirm with **Yes**.

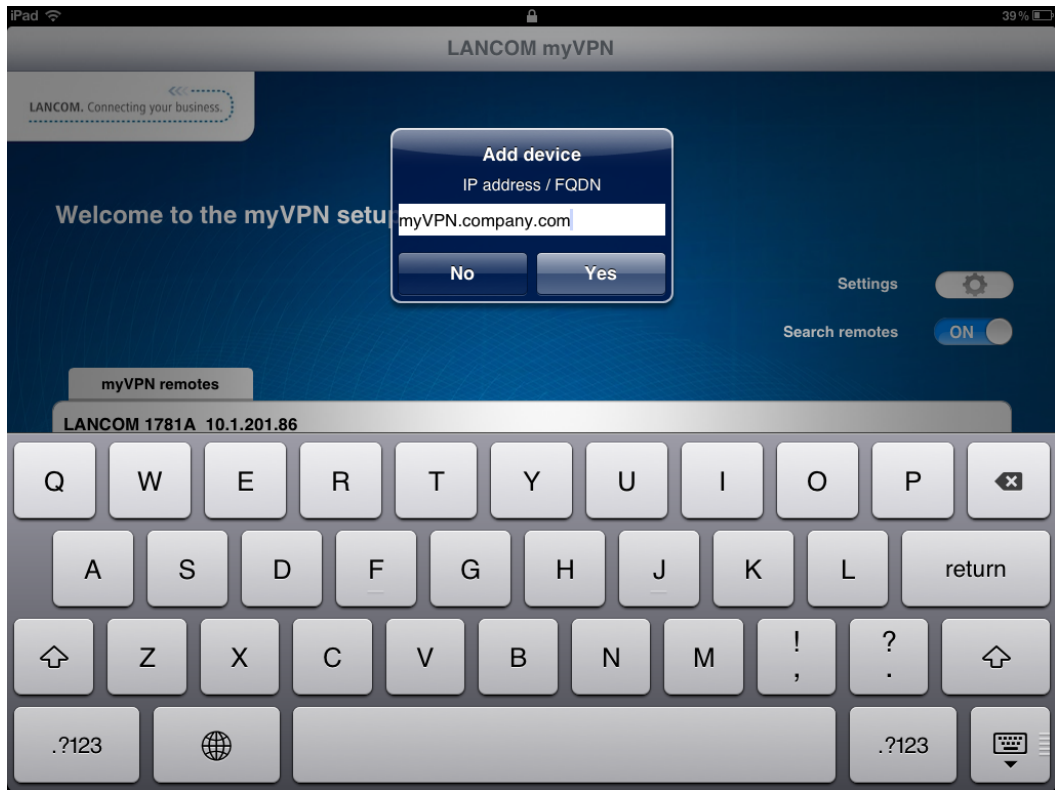

- The app now displays all VPN devices that offer profiles for the LANCOM myVPN app.

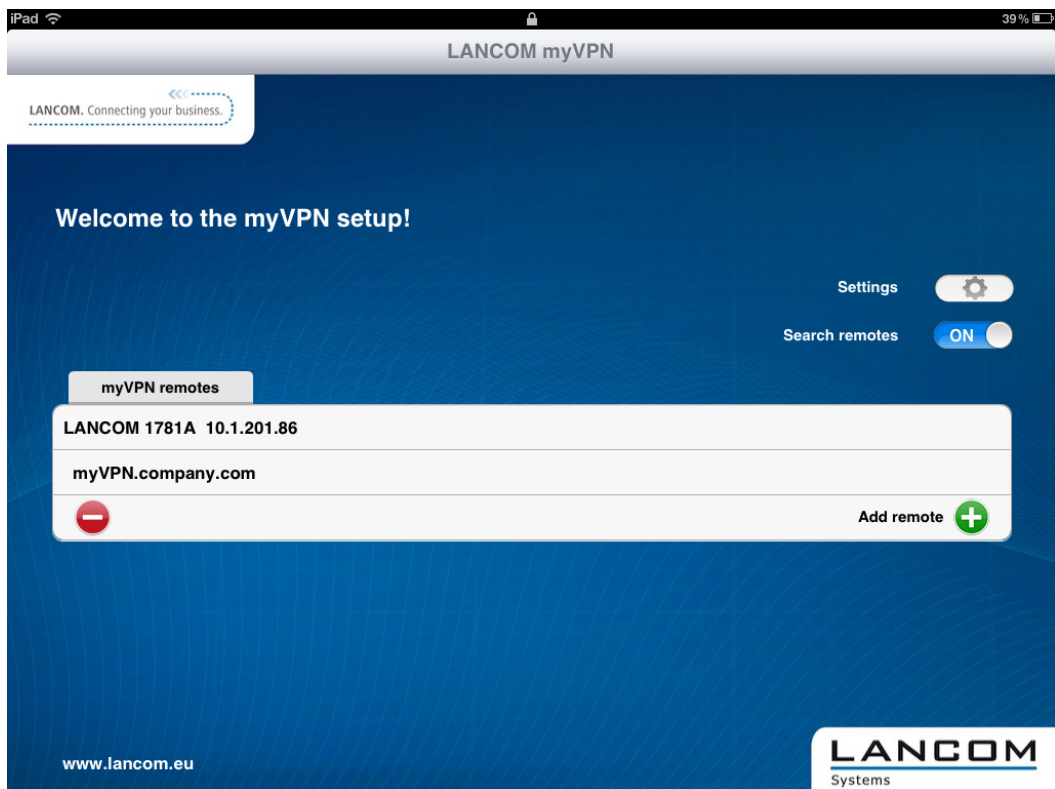

6. Tap on the entry in the list to select the desired VPN device and then enter the PIN required for retrieving the VPN profile.

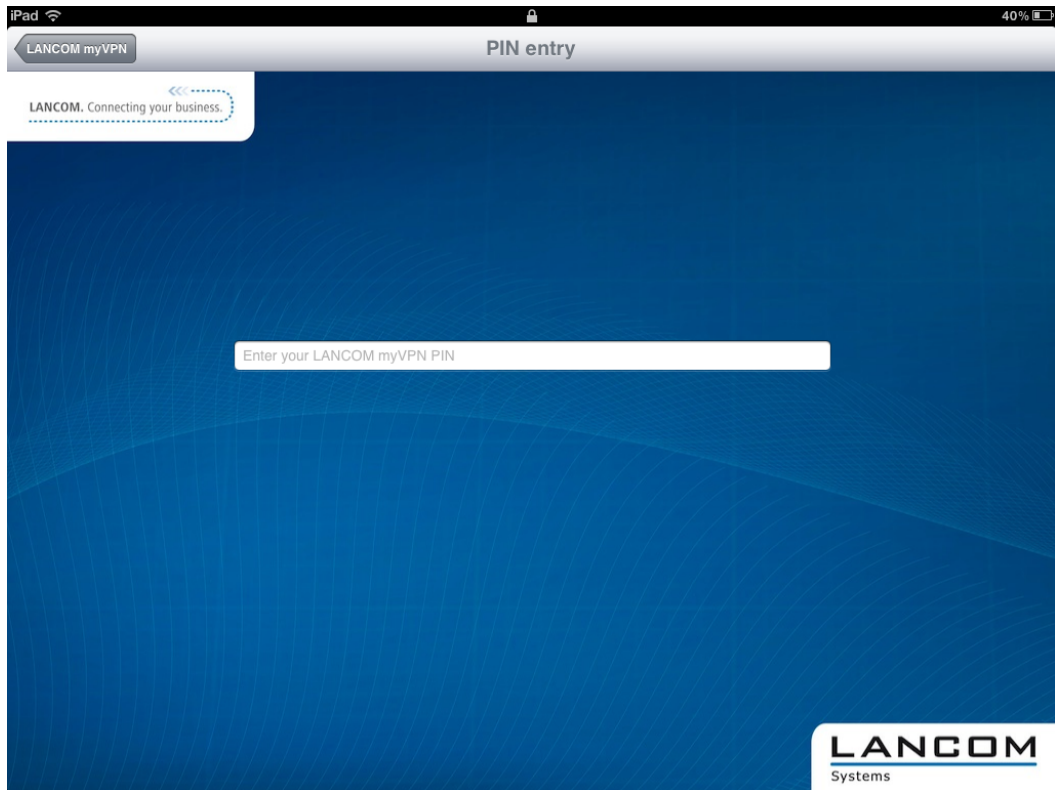

- ⓘ If you enter your PIN incorrectly 5 times, the myVPN module on the LANCOM VPN device will be completely locked for a definite period. In this state, VPN connections remain possible for iOS devices that previously set up their VPN access accounts successfully. However, iOS devices cannot retrieve myVPN profiles from this VPN device so long as the lock is in place. An administrator can re-enable the myVPN module.

7. In the case that the following dialog contains a notice about a non-signed certificate, simply confirm with the **Yes** button.



8. In the next dialog, confirm the request to install the profile with the **Install** button.

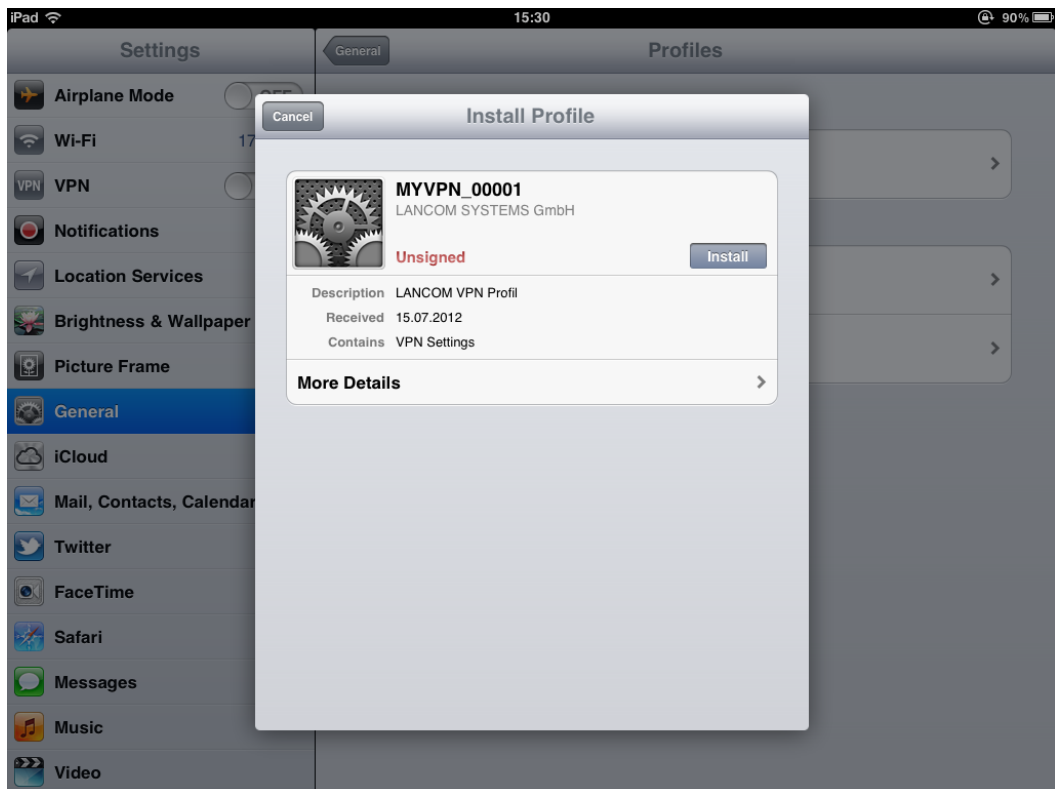



Confirm the necessary changes to the settings on your iOS device.

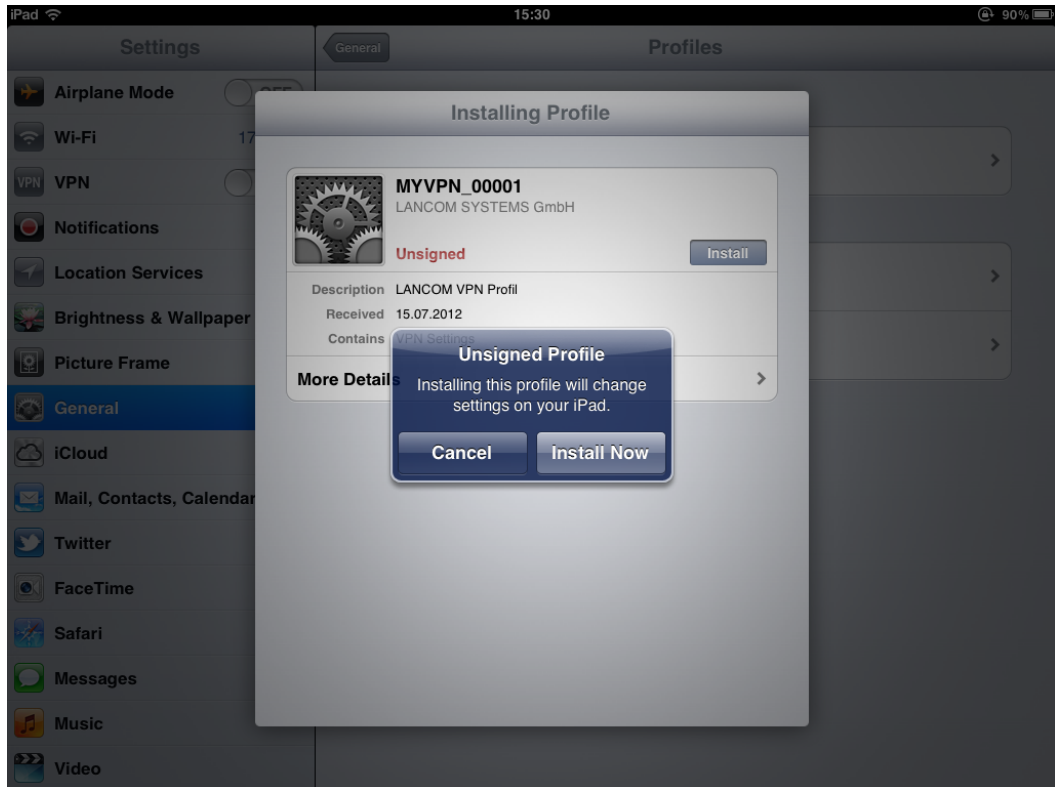

9. The next step of the installation routine is to enter the password for the VPN access account. By default the VPN password is the PIN for the myVPN profile. If you enter the password for the VPN access account here, the iOS device can then establish VPN connections to your company network without requesting a password again. If you leave

the box for the VPN password empty, you will be requested for the VPN password every time you connect using the iOS device. Confirm your selection with the **Next** button.

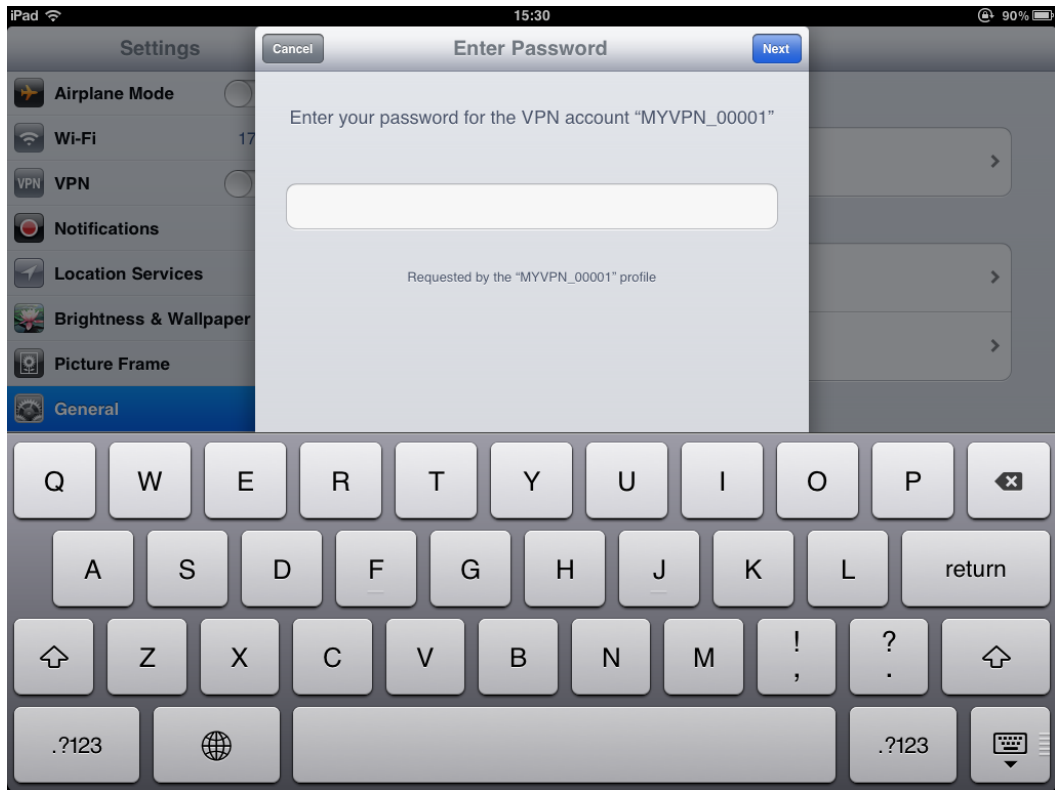

- ⓘ For security reasons we recommend that you do **not** save the VPN-access password on the device. It is a better policy to enter it each time you make the connection.

10. The VPN profile is now fully installed on your iOS device and is ready for establishing a VPN connection to your company network. Confirm that the installation has been concluded by clicking on the **Done** button.

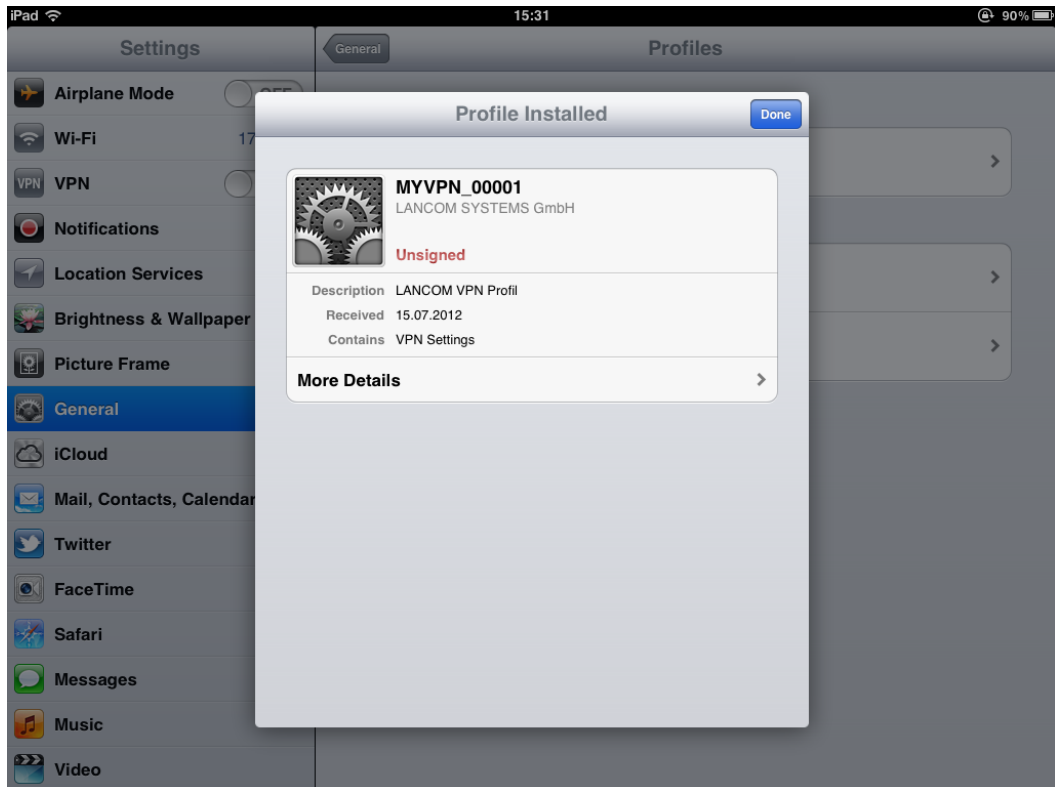

Once retrieved from an iOS device, the myVPN profile is disabled on the LANCOM VPN device. You can check your status with LANconfig by navigating to the configuration area **VPN > myVPN** and viewing the **myVPN accounts** list:

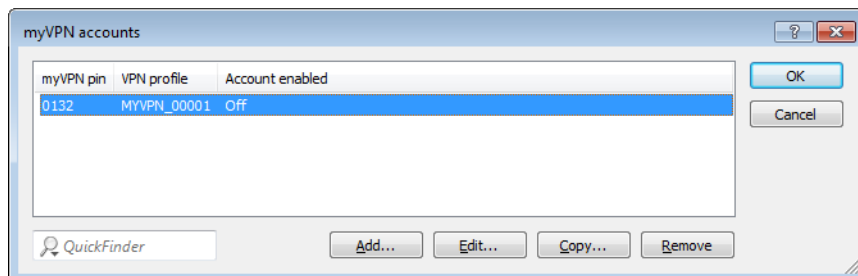

- ! By disabling the myVPN profile, other IOS device are prevented from installing the same myVPN profile and thus using the same VPN access credentials. However, disabling the myVPN profile has no effect on the VPN connection itself.

### Establishing and closing the VPN connection on the iOS device

After you have installed the VPN profile on your iOS device with the LANCOM myVPN app, you establish and close the VPN connection to your company network as follows:

1. Activate the VPN tunnel in the configuration area **Settings** under the option **VPN**.

- The following dialog already displays the user name from the myVPN profile. Enter the password for the VPN connection and confirm with **OK**.

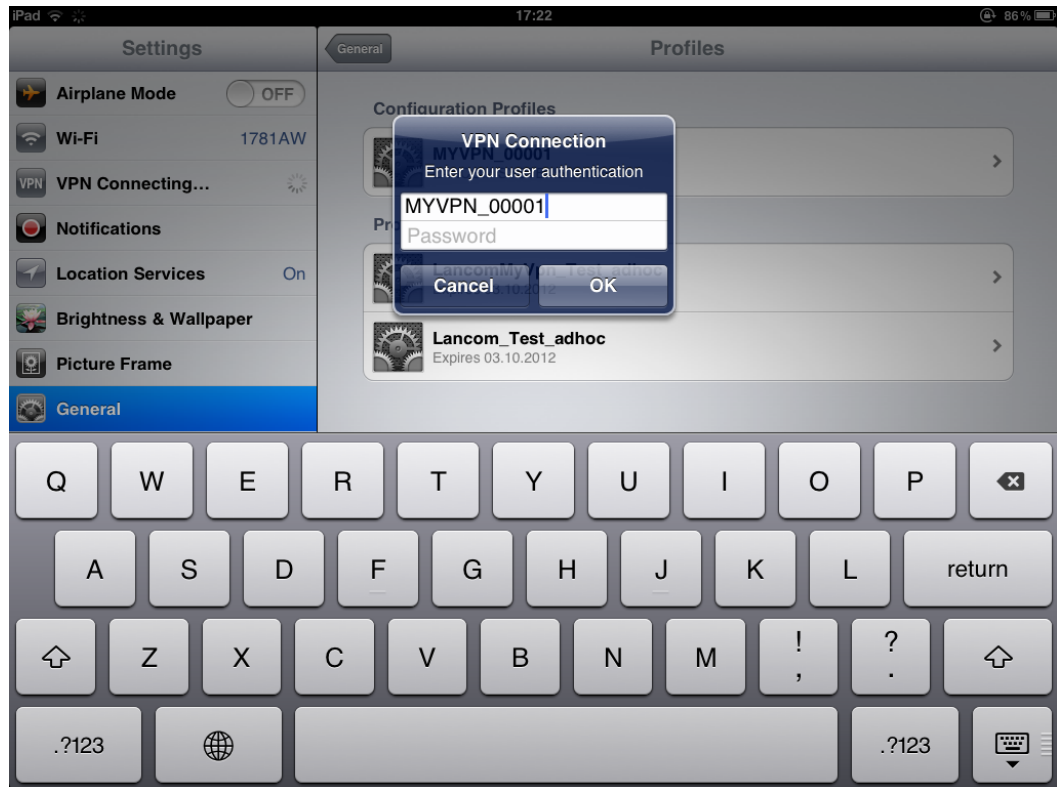

- ! By default, the password for the VPN connection is the PIN for the myVPN profile.
  - ! The password is already displayed if you entered the password for the VPN connection while installing the myVPN profile. In this case the connection is established directly without showing this window.
- Close the VPN connection on your iOS device in the configuration area **Settings** under the option **VPN**.

### Deleting a VPN profile from the iOS device

To delete the VPN profile you can use the LANCOM myVPN app:

- Navigate to **Settings** > **General** > **Profiles** to the list of available profiles on your iOS device.

2. Select the profile, click on **Remove** and confirm the action again in the next dialog with **Remove**.

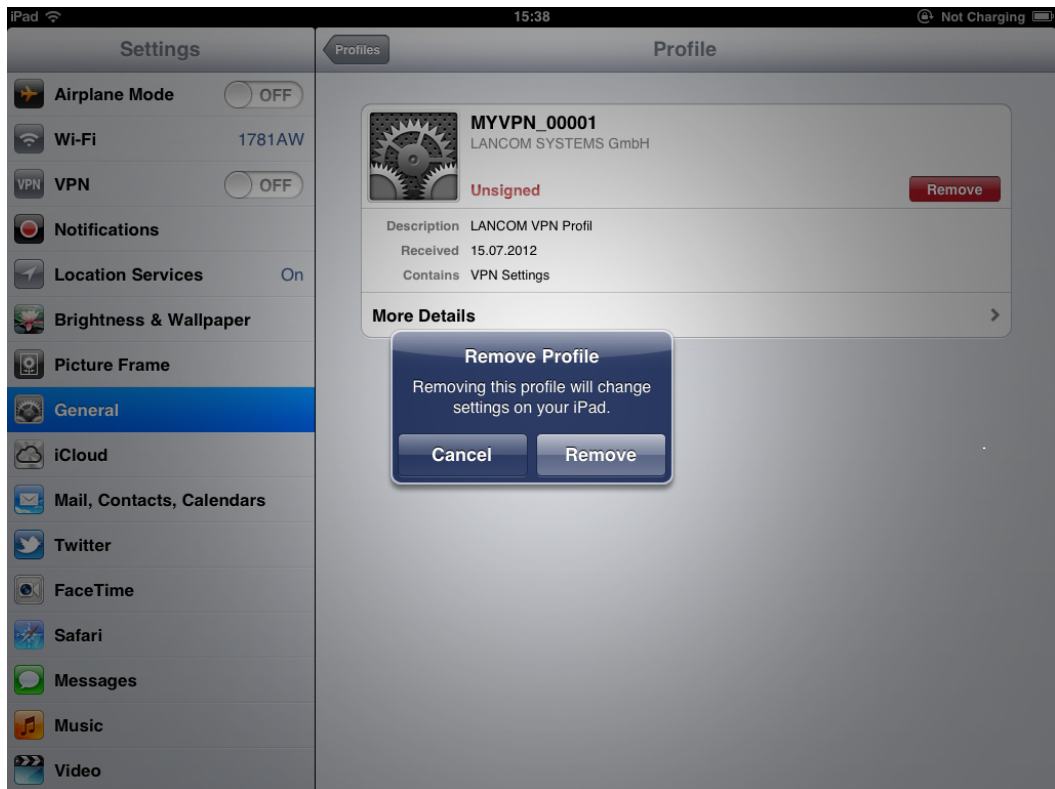

## Additions to LANconfig

### Configuring the LANCOM myVPN app

Under **VPN > myVPN** you can manually adjust the settings for the LANCOM myVPN app.

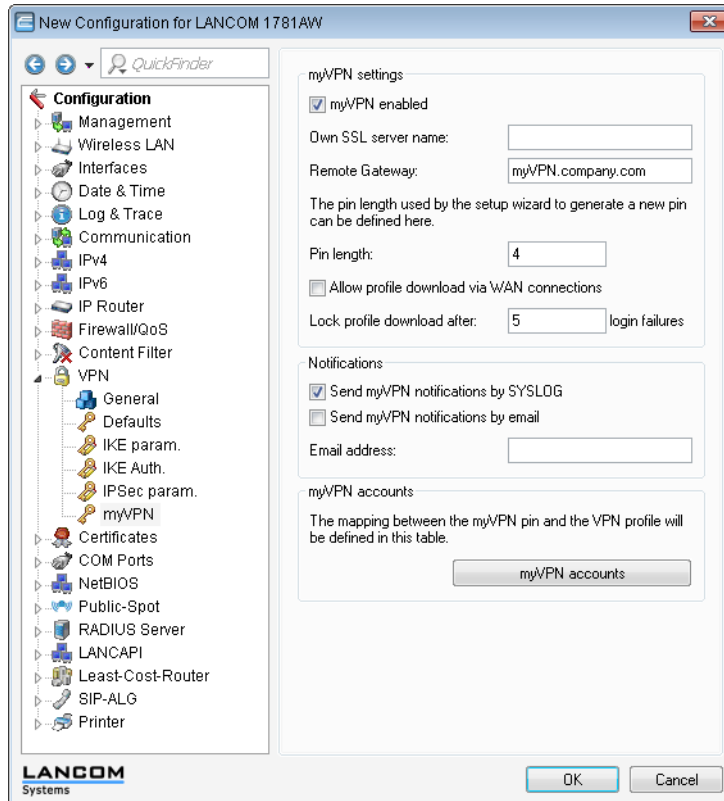

Check the **myVPN enabled** box to allow the LANCOM myVPN app to load a VPN profile.

Specify the **Device name** here if a trusted SSL certificate is installed on this device. This ensures that the IOS device does not issue a warning about an untrusted certificate when the profile is retrieved.

Use the field **Remote gateway** to enter the WAN address of the router or its name as resolved by public DNS servers. If the myVPN app cannot find the remote gateway by means of automatic search, you should enter this gateway into the myVPN app.

The item **PIN length** sets the length of new PINs generated by the setup wizard (default = 4).

Activate the option **Send myVPN notifications by SYSLOG** to send messages about the myVPN app to SYSLOG.

Activate the option **Send myVPN notifications by e-mail** to send messages about the myVPN app to a specified e-mail address.

These messages include:

- Successful profile retrieval
- Disabled login for LANCOM myVPN due to too many failed attempts
- Re-enabling of the login (irrespective of whether this is done manually or if the specified time period has expired)

Specify the **E-mail address** to which messages about the myVPN app are to be sent.

 The transmission of e-mails must be enabled in the VPN device.

The item **myVPN accounts** is used to assign the myVPN PIN to the VPN profiles.

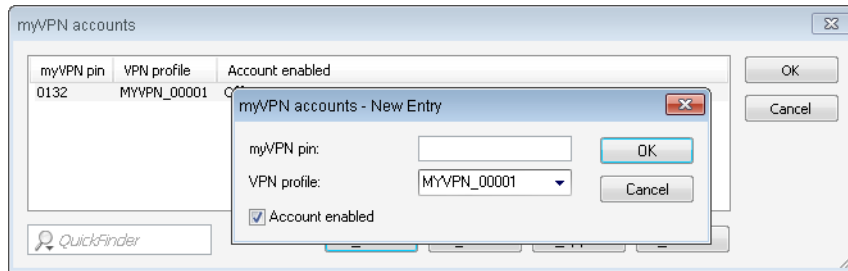

Here you determine which **VPN profile** is to supply data to the myVPN app upon retrieval of the profile.

You set the myVPN PIN that is to be entered when the LANCOM myVPN app is to retrieve the profile.

**! Security notice:** As a security feature of myVPN, the repeated incorrect entry of a PIN causes the device to temporarily disable profile retrieval, and a notification is sent by SYSLOG and by e-mail. After five failed attempts, the device disables profile retrieval for 15 minutes. Five more failed attempts, profile retrieval is disabled for a day. In case of further failed attempts, the time periods vary. Manually releasing this lock resets the corresponding counter. Please also be aware that an attempt to retrieve the profile while access is disabled (e. g. when the profile has previously been retrieved successfully) is also considered by the device to be a failed attempt.

You activate the profile by checking the **Account enabled** box.

**!** After the profile has been retrieved successfully, the device automatically disables the corresponding profile to avoid the repeated download by another device.

Once you save these settings to the device, the myVPN module is active on the selected VPN device. On your iOS device, you can now start the LANCOM myVPN app and enter the PIN to retrieve the VPN profile.

## Additions to the menu system

### myVPN

The "myVPN" function is used by devices with the iOS operating system. These are able to automatically retrieve VPN profiles and the internal iOS VPN client is configured to suit. At the router's end, you must configure the VPN profile and the parameters for myVPN. With the aid of the LANCOM myVPN app and a suitable PIN, you can configure your device for VPN dial-in in just a few easy steps.

More information on the myVPN app is available on the [LANCOM homepage](#).

#### SNMP ID:

2.19.28

#### Telnet path:

Telnet path: Setup > Vpn > myVPN

#### Operating

Use this switch to activate myVPN for this device.

#### SNMP ID:

2.19.28.1

#### Telnet path:

Telnet path: Setup > Vpn > myVPN

#### Possible values:

Yes

No

**Default:**

No

**PIN length**

This item sets the length of new PINs generated by the setup wizard.

**SNMP ID:**

2.19.28.2

**Telnet path:**

**Telnet path:**Setup > Vpn > myVPN

**Possible values:**

Maximum length: 12

Minimum length: 4

**Default:**

4

**Device hostname**

Enter the device name here if a trustworthy SSL certificate is installed on this device. This ensures that the IOS device does not issue a warning about an untrusted certificate when the profile is retrieved.

**SNMP ID:**

2.19.28.3

**Telnet path:**

**Telnet path:**Setup > Vpn > myVPN

**Possible values:**

Max. 31 characters from

0-9

a-z

A-Z

#@[{}~!\$%&'()\*+,-./:;<=>?[ \^\_`

**Default:**

Blank

**Mapping**

This table assigns the myVPN PIN to the VPN profiles.

**SNMP ID:**

2.19.28.4

**Telnet path:**

**Telnet path:**Setup > Vpn > myVPN

**PIN**

Define here the PIN to be entered into the myVPN app in order to retrieve the profile.



The myVPN setup wizard also uses this PIN in the PPP list for the actual VPN login. If you change your PIN here, you must also change it in LANconfig under **Communication > Protocols > PPP list** if you wish to avoid having a different PIN.

**!** **Security notice:** As a security feature of myVPN, the repeated incorrect entry of a PIN causes the device to temporarily disable profile retrieval, and a notification is sent by SYSLOG and by e-mail. After three failed attempts, the device disables profile retrieval for 15 minutes. A further three failed attempts cause the profile retrieval to be disabled for 24 hours. In case of further failed attempts, the time periods vary. Manually releasing this lock resets the corresponding counter. Please also be aware that an attempt to retrieve the profile while access is disabled (e. g. when the profile has previously been retrieved successfully) is also considered by the device to be a failed attempt.

**SNMP ID:**

2.19.28.4.1

**Telnet path:****Telnet path:**Setup > Vpn > myVPN > Mapping**Possible values:**

Max. 12 digits from 1234567890

**Default:**

Blank

**VPN profile**

Here you can determine which VPN profile is to supply data to the myVPN app upon retrieval of the profile.

**SNMP ID:**

2.19.28.4.2

**Telnet path:****Telnet path:**Setup > Vpn > myVPN > Mapping**Possible values:**

16 characters from

0-9

a-z

A-Z

@[!~!\$%&amp;'()+-./;&lt;=&gt;?[\]^\_.

**Default:**

Blank

**Operating**

This switch activates the profile retrieval by means of the myVPN app. After the profile has been retrieved successfully, the device automatically disables the corresponding profile to avoid the repeated download by another device.

**SNMP ID:**

2.19.28.4.3

**Telnet path:****Telnet path:**Setup > Vpn > myVPN > Mapping**Possible values:**

No

Yes

**Default:**

No

**Re-enable login**

The command `do re-enable-login` releases the lock that was caused by failed attempts. If required, this generates a message about the re-enabling via SYSLOG or e-mail.

**SNMP ID:**

2.19.28.5

**Telnet path:**

**Telnet path:**Setup > Vpn > myVPN

**E-mail notification**

Activate this option to send messages about the myVPN app to a specific e-mail address. These messages include:

- Successful profile retrieval
- Disabled login for myVPN due to too many failed attempts
- Re-enabling of the login (irrespective of whether this is done manually or if the specified time period has expired)

**SNMP ID:**

2.19.28.6

**Telnet path:**

**Telnet path:**Setup > Vpn > myVPN

**Possible values:**

No

Yes

**Default:**

No

**E-mail address**

Specify the e-mail address to which messages about the myVPN app are to be sent.

**SNMP ID:**

2.19.28.7

**Telnet path:**

**Telnet path:**Setup > Vpn > myVPN

**Possible values:**

Max. 63 characters from

0-9

a-z

A-Z

@[{}~!\$%&'()\*+,-./:;<=>?[ \]^\_`

**Default:**

Blank

**Syslog**

Activate this option to send messages about the myVPN app to SYSLOG. These messages include:

- Successful profile retrieval
- Disabled login for myVPN due to too many failed attempts
- Re-enabling of the login (irrespective of whether this is done manually or if the specified time period has expired)

**SNMP ID:**

2.19.28.8

**Telnet path:**

**Telnet path:**Setup > Vpn > myVPN

**Possible values:**

No

Yes

**Default:**

No

**Remote gateway**

Here you enter the WAN address of the router or its name as resolved by public DNS servers. If the myVPN app cannot find the remote gateway by means of automatic search, you should enter the gateway into the app as well.

**SNMP ID:**

2.19.28.9

**Telnet path:**

**Telnet path:**Setup > Vpn > myVPN

**Possible values:**

Max. 63 characters from

0-9

a-z

A-Z

#@[{}~!\$%&'()+,-./:;<=>?[ \]^\_`.

**Default:**

Blank

## 11.18 Addition(s) to LCOS 8.80

### 11.18.1 Deleting all VPN errors with one command

As of LCOS 8.80, you have the ability to delete all of the VPN errors in a device with a single command.

## Additions to the menu system

### Additions to the Status menu

#### Delete conn errors

Connections (**Status > VPN > Connections**), which show an error in the **Last error** column.

**SNMP ID:**

1.26.38

**Telnet path:****Status > VPN**

## 11.18.2 Default proposals for IKE and IPSec

The proposals for IKE and IPSec now support a key length of 256 bits in the default settings.



A firmware upgrade initially does not enable this change, so avoiding any problems for existing installations. To accept the changes, you must perform a reset of the device or reset the tables. For new devices with LCOS 8.62 or later, the new defaults are already active.

## 11.18.3 Selecting DH group 14 for VPN connections

The IKE and PFS group for VPN connections now support the DH group 14 with a key length of 2048.

### Additions to the Setup menu

#### VPN

This menu contains the configuration of the Virtual Private Network (VPN).

**SNMP ID:**

2.19

**Telnet path:****Setup**

#### Aggressive mode IKE group default

This IKE group is used for aggressive-mode connections when the remote address cannot be identified by its IP address but by a subsequently transmitted ID.

**SNMP ID:**

2.19.11

**Telnet path:****Setup > VPN****Possible values:**

1: MODP-768

2: MODP-1024

5: MODP-1536

14: MODP-2048

**Default:**

2: MODP-1024

**Main mode IKE group default**

This IKE group is used for main-mode connections when the remote address cannot be identified by its IP address but by a subsequently transmitted ID.

**SNMP ID:**

2.19.14

**Telnet path:****Setup > VPN****Possible values:**

1: MODP-768

2: MODP-1024

5: MODP-1536

14: MODP-2048

**Default:**

2: MODP-1024

**Quick mode PFS group default**

This IPsec group is used for simplified dial-in with certificates.

**SNMP ID:**

2.19.20

**Telnet path:****Setup > VPN****Possible values:**

0: No PFS

1: MODP-768

2: MODP-1024

5: MODP-1536

14: MODP-2048

**Default:**

2: MODP-1024

**Layer**

Define other parameters for the individual VPN connections here.

**SNMP ID:**

2.19.7

**Telnet path:****Setup > VPN**

### PFS group

Perfect Forward Secrecy (PFS) is a security feature of encryption algorithms. The PFS group specifies the length of the Diffie-Hellman key used to encrypt the IKE negotiation.

**SNMP ID:**

2.19.7.3

**Telnet path:****Setup > VPN > Layer****Possible values:**

0: No PFS

1: MODP-768

2: MODP-1024

5: MODP-1536

14: MODP-2048

**Default:**

2: MODP-1024

### IKE group

The IKE group specifies the length of the Diffie-Hellman key used to encrypt the IKE negotiation.

**SNMP ID:**

2.19.7.4

**Telnet path:****Setup > VPN > Layer****Possible values:**

1: MODP-768

2: MODP-1024

5: MODP-1536

14: MODP-2048

**Default:**

2: MODP-1024

## 11.18.4 Replay detection

Replay detection is a feature of the IPSec standard for the detection of so-called replay attacks. In a replay attack, an unauthorized station logs data and sends this, either repeatedly or with a delay, to a remote site to simulate a different identity.

Replay detection defines a certain number of consecutive packets (a "window" with the length of "n"). Because the IPSec standard provides the packages with a continuous sequence number, the receiving VPN device can determine whether a packet contains a sequence number from the permitted window. If, for example, the current highest received sequence number is 10,000 and the window width is 100, then a sequence number of 9,888 is outside the permitted window.

Replay detection discards received packets if:

- they contain a sequence number before the current window, in which case they are seen as being too old, or if
- they contain a sequence number which has already been received by the VPN device, in which case replay detection evaluates this package as part of a replay attack

Please consider the following aspects when configuring the replay-detection window:

- If you select too large a window, then replay detection may overlook a replay attack
- If you make the window too small, replay detection may drop legitimate packets that became reordered during data transfer, so generating errors on the VPN connection

 You have to weigh-up the application of replay detection for your particular case. Only activate replay detection if the security of the VPN connection is more important to you than interference-free data transfer.

## Additions to the menu system

### Anti-replay window size

Used for detecting replay attacks, this parameter defines the size of the window (i.e. number of packets) within which a VPN device considers the sequential number of the received packets to be up-to-date. The VPN device drops packets that have a sequence number older than or duplicated within this window.

#### SNMP ID:

2.19.30

#### Telnet path:

**Telnet path:**Setup > Vpn > myVPN

#### Possible values:

Max. 5 numbers

#### Default:

0

#### Special values:

A value of 0 disables replay detection.

## 11.18.5 myVPN



The LANCOM myVPN app offers you a very easy way to set up a VPN connection to your company network from your iPhone, iPad or iPod (or from any iOS device in general). The LANCOM myVPN app offers the following functions:

- Highly secure, mobile VPN connections
- Handles the complex VPN configuration of the VPN client integrated into iOS devices and of the LANCOM router
- PIN-protected authentication for VPN tunnel creation
- Access control with configurable firewall rules on the LANCOM VPN gateway
- LANCOM myVPN user management and automatic detection of myVPN-enabled LANCOM gateways
- For version 4.1 iOS devices and later

After its installation, the LANCOM myVPN app retrieves a VPN profile from your LANCOM VPN device and automatically configures all of the necessary settings on the iOS device. You can then use the internal features of the iOS to establish a VPN connection to your company network in just a few steps.

### Using the Setup Wizard in LANconfig to set up a VPN profile for the LANCOM myVPN app

This is how to use the Setup Wizard to provide an access account for a VPN client on an iOS device:

1. Start LANconfig, for example from the Windows start menu with **Start > Programs > LANCOM > LANconfig**.

LANconfig now automatically searches the local network for devices.

2. Choose the required device from the selection window in LANconfig and select the **Setup Wizard** button or use the menu under **Tools > Setup Wizard**.
3. Select the item **Provide remote access (RAS, VPN)** and then click on **Next**.

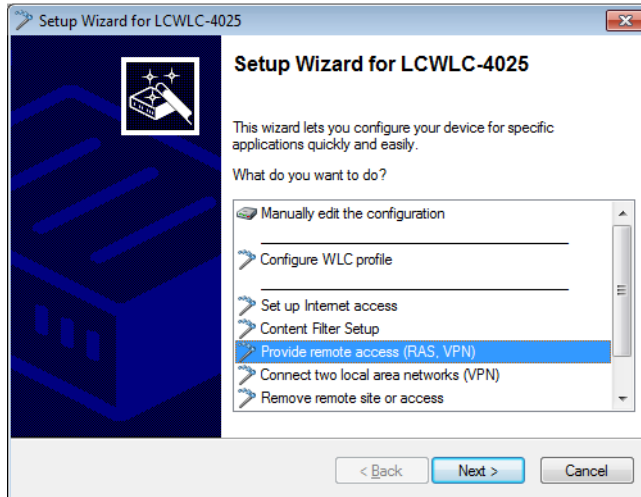

You can skip the following information dialog with **Next**.

4. From the drop-down list select the option **LANCOM myVPN client** and click on **Next**.

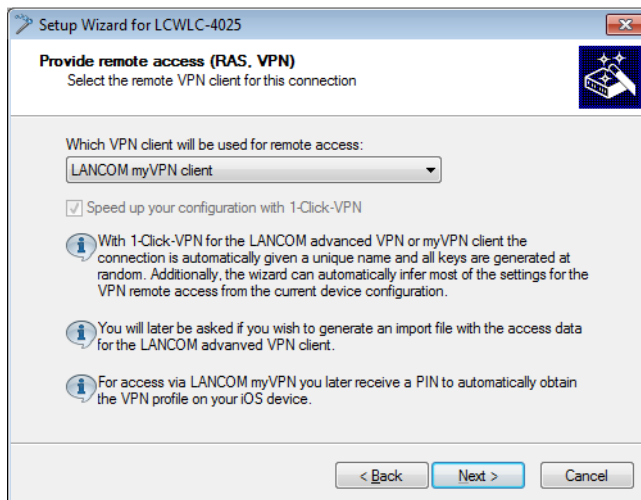



5. Enter a name for this access account and select the address at which the VPN client on the iOS device can reach the router from the Internet. To continue, click on **Next**.

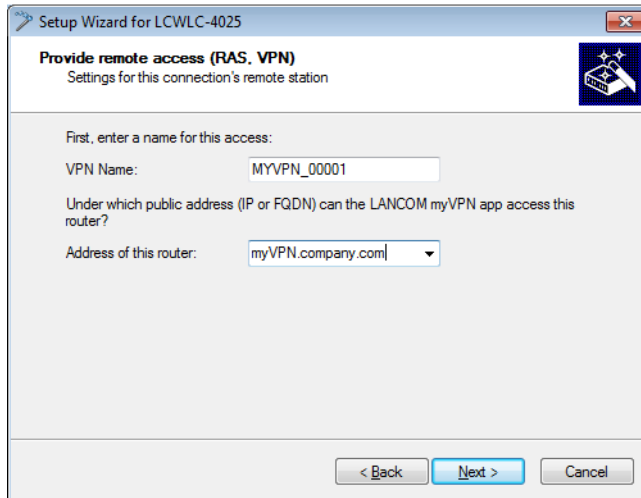

Setup Wizard for LCWLC-4025

**Provide remote access (RAS, VPN)**  
Settings for this connection's remote station

First, enter a name for this access:

VPN Name:

Under which public address (IP or FQDN) can the LANCOM myVPN app access this router?

Address of this router:

< Back   Next >   Cancel

The Setup Wizard will suggest a name that you can accept if you wish.

6. If you have not yet configured a pool for allocating IP addresses to the connecting VPN devices, the wizard will prompt you the first time to specify a range of IP addresses for the pool in the following dialog. When connecting, the VPN device automatically assigns a free IP address to the iOS device from this pool.

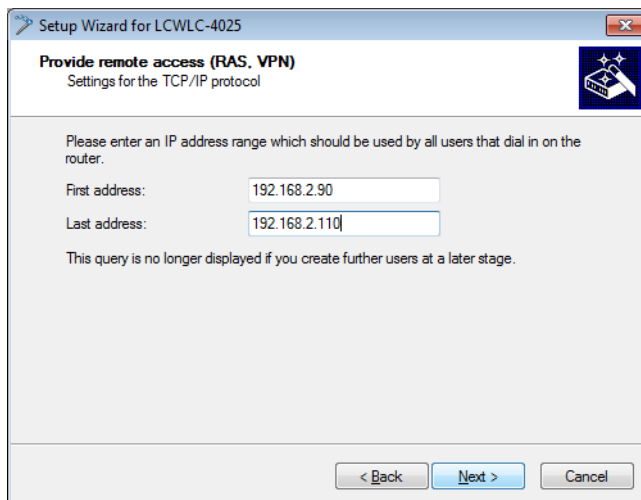

Setup Wizard for LCWLC-4025

**Provide remote access (RAS, VPN)**  
Settings for the TCP/IP protocol

Please enter an IP address range which should be used by all users that dial in on the router.

First address:

Last address:

This query is no longer displayed if you create further users at a later stage.

< Back   Next >   Cancel

- ! If you have already configured a pool for allocating IP addresses to the connecting VPN devices, the VPN device automatically uses an address from the address pool, and the wizard skips the dialog shown here.

7. The Setup Wizard displays the profile name and the PIN that was auto-generated for the VPN client. If you want to print out the PIN now, select the option **Print PIN now**. Click on **Next**.

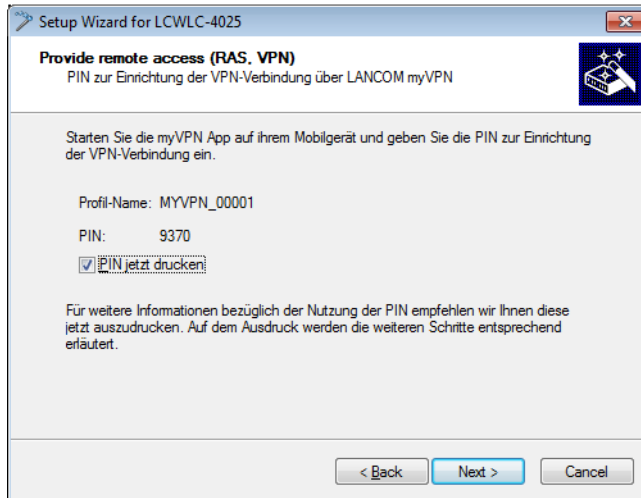

8. By clicking on **Finish** the Setup Wizard stores all the settings on the corresponding VPN device. If applicable, it then starts printing out the myVPN PIN.  
The myVPN module now enabled on the selected VPN device. On your iOS device, you can now start the myVPN app and enter the PIN to retrieve the VPN profile.

### Retrieve the VPN profile with the LANCOM myVPN app

This is how you can use the LANCOM myVPN app on your iOS device to retrieve a VPN profile from a LANCOM VPN device:

- ! The purpose of the LANCOM myVPN app is to set up the VPN client on iOS devices with the correct parameters and in a quick and easy fashion. The establishment of the VPN connection to the company network itself is handled directly by the VPN client in the iOS device.

1. Download the LANCOM myVPN app from the Apple App Store.

2. Open the app on your iPhone or iPad.

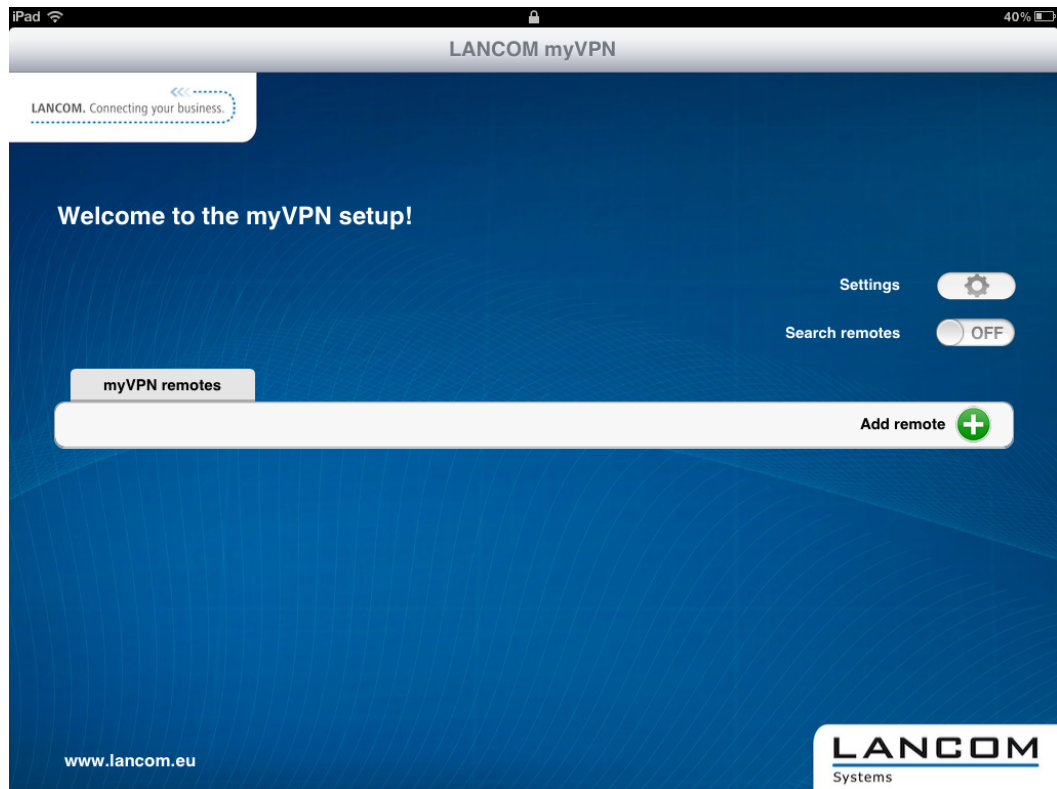

3. Optional: Enable the option **Automatic search** to find VPN devices with an activated LANCOM myVPN module, which are available to iOS devices via WLAN.

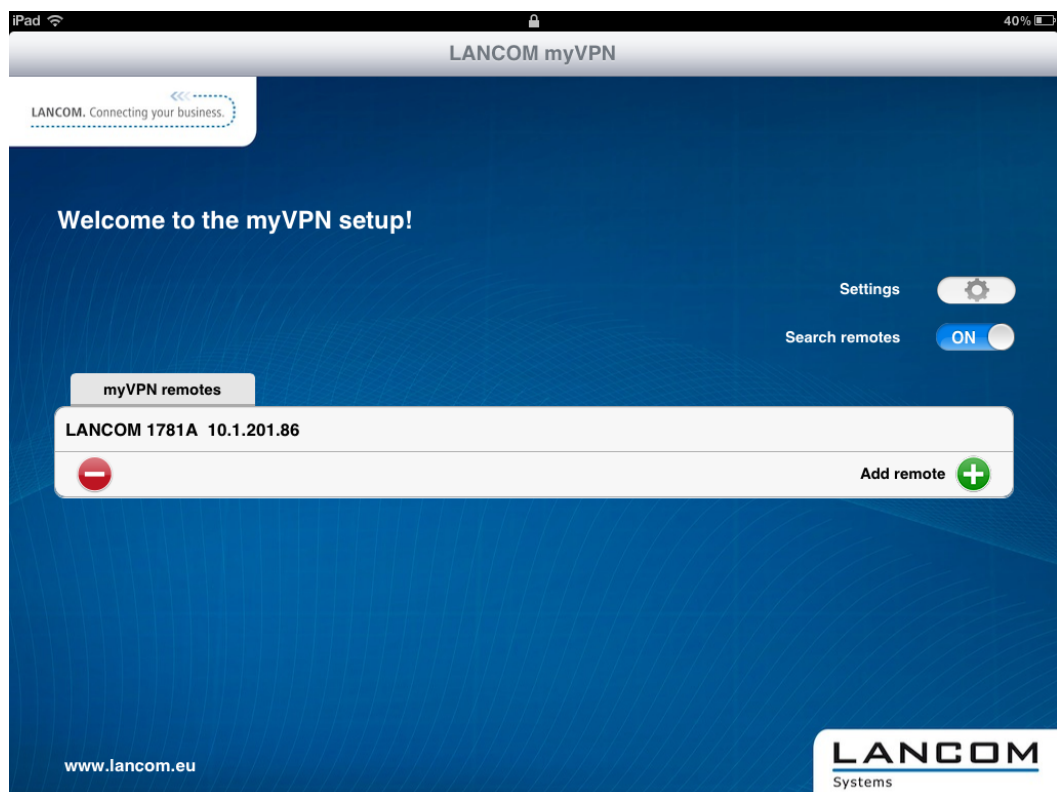

! The iOS device now lists all VPN devices which are accessible via WLAN and which have an active LANCOM myVPN module. However, the inclusion of an entry in this list does not necessarily mean that your iOS device can retrieve a LANCOM myVPN profile from this VPN device.

4. Optional: Select the option **Add device manually** to enter the IP address or name of VPN devices that the iOS device can access via an Internet connection (3G or WLAN). In the dialog that follows, enter the IP address or the name of the VPN device and confirm with **Yes**.

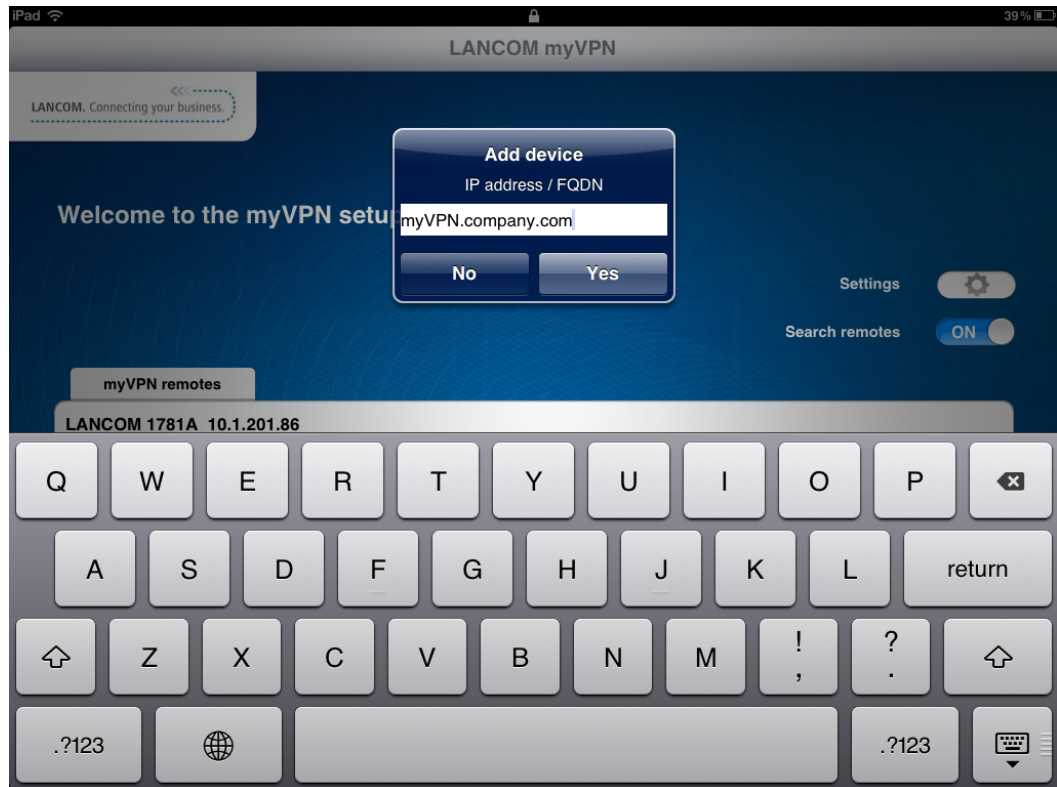

- The app now displays all VPN devices that offer profiles for the LANCOM myVPN app.

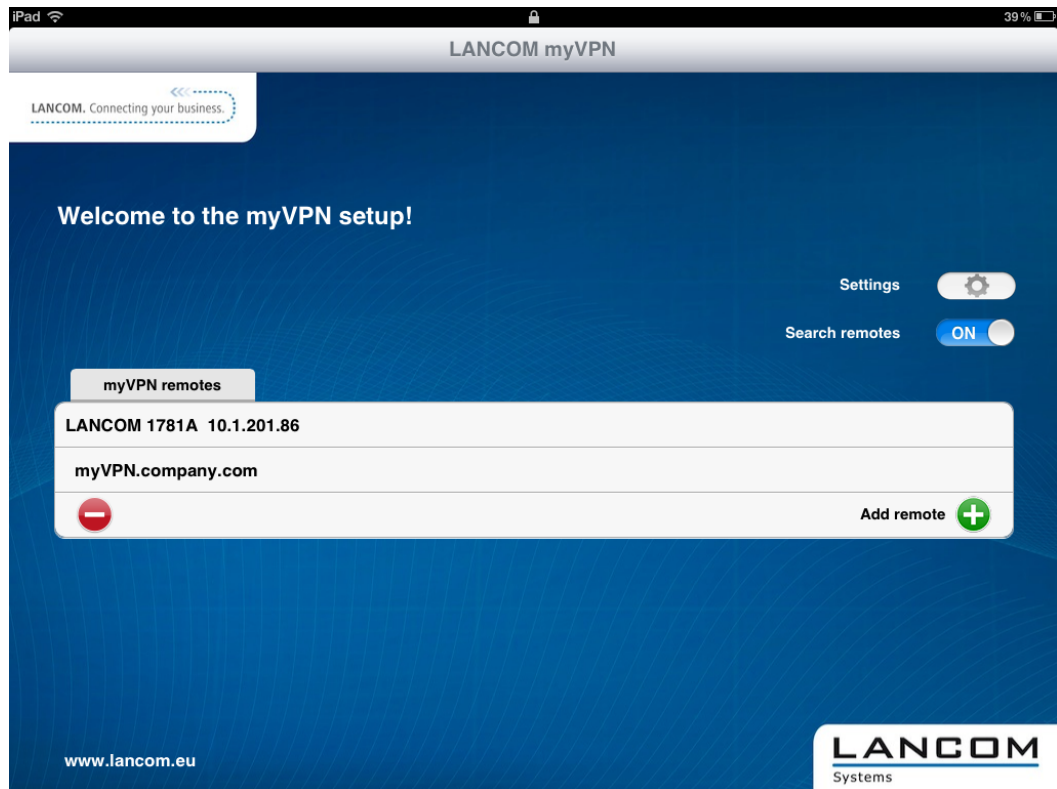

- Tap on the entry in the list to select the desired VPN device and then enter the PIN required for retrieving the VPN profile.

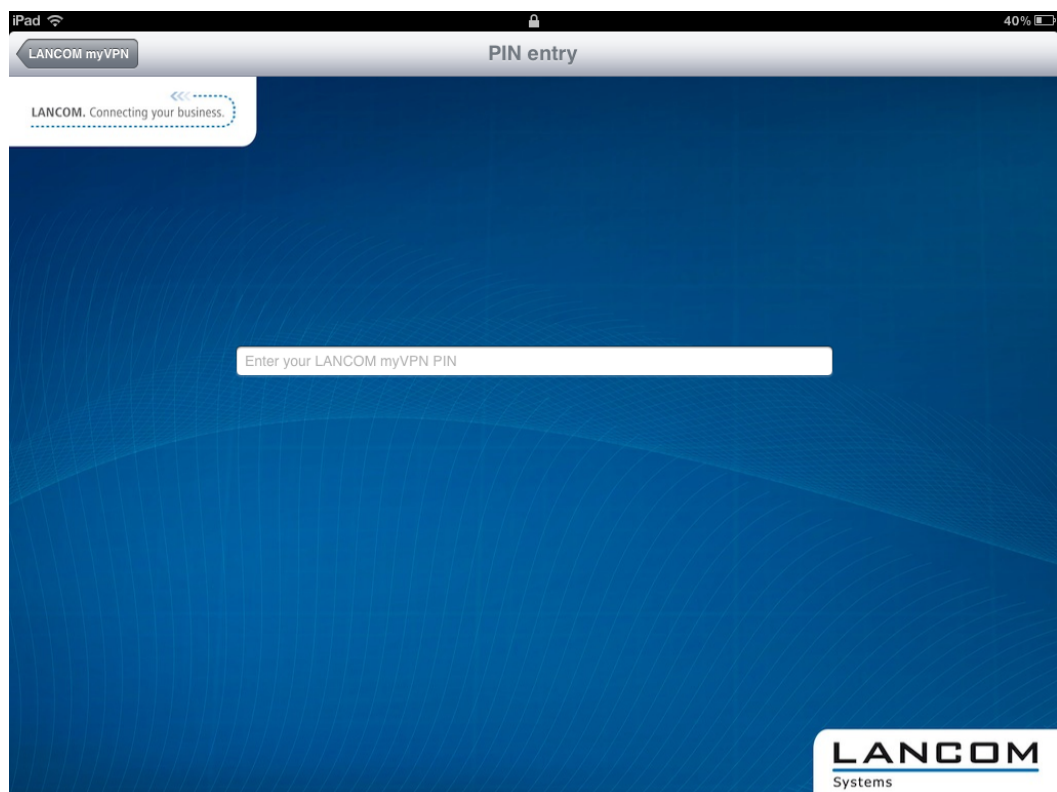

- ⓘ If you enter your PIN incorrectly 5 times, the myVPN module on the LANCOM VPN device will be completely locked for a specific time period. In this state, VPN connections remain possible for iOS devices that previously set up their VPN access accounts successfully. However, iOS devices cannot retrieve myVPN profiles from this VPN device so long as the lock is in place. An administrator can re-enable the myVPN module.

7. If the following dialog contains a notice about an unsigned certificate, simply confirm it with **Yes**.



- In the next dialog, confirm the request to install the profile with the **Install** button.

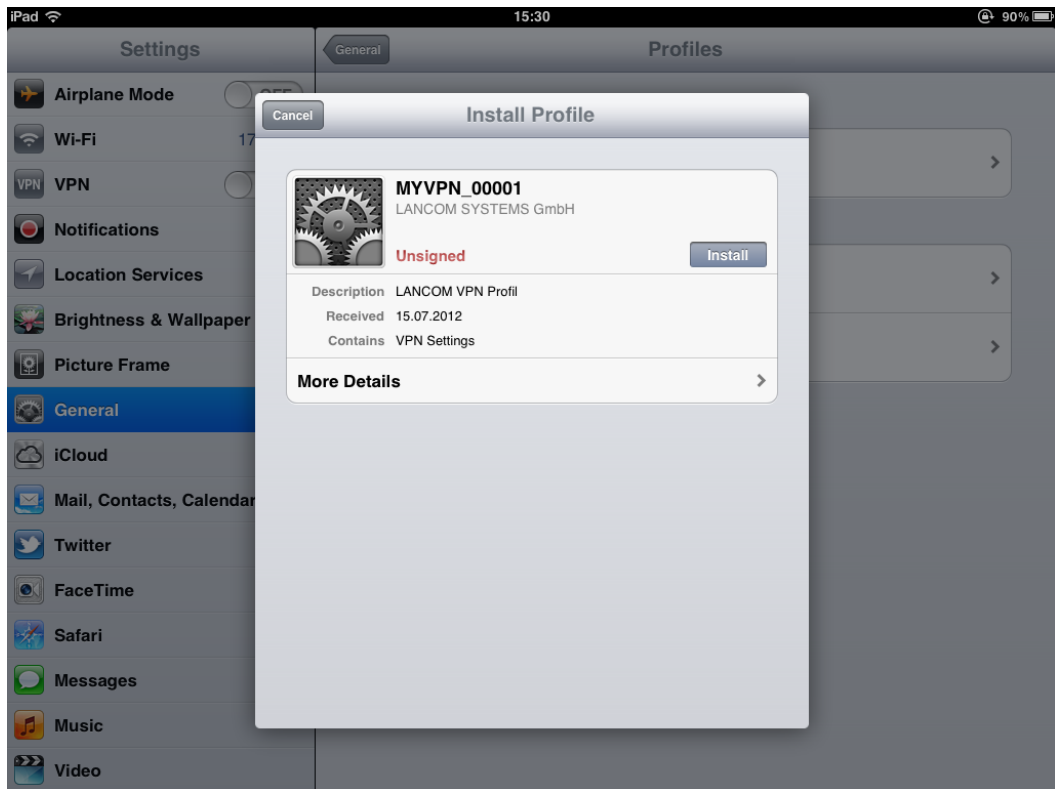

Confirm the necessary changes to the settings on your iOS device.

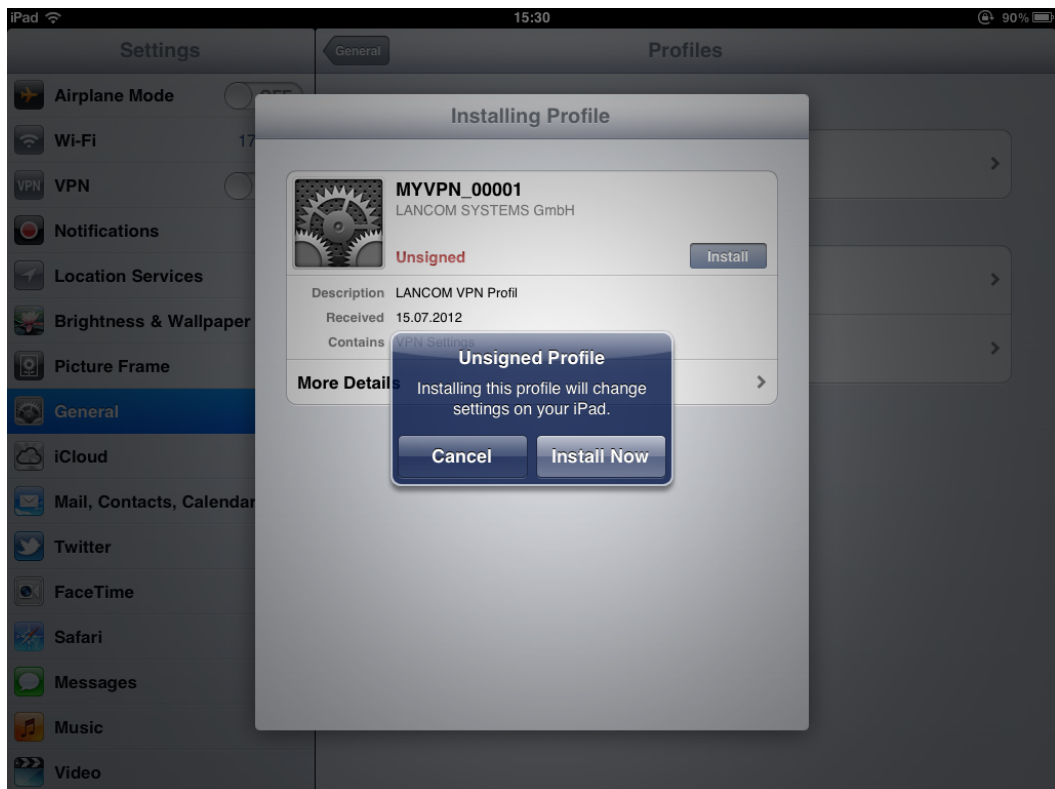

- The next step of the installation routine is to enter the password for the VPN access account. By default, the VPN password is the PIN for the myVPN profile. If you enter the password for the VPN access account here, the iOS device can establish a VPN connection to your company network without requesting a password. If you leave the box for the VPN password empty, you will be asked for the VPN password every time you connect using the iOS device. Confirm your selection with the **Next** button.

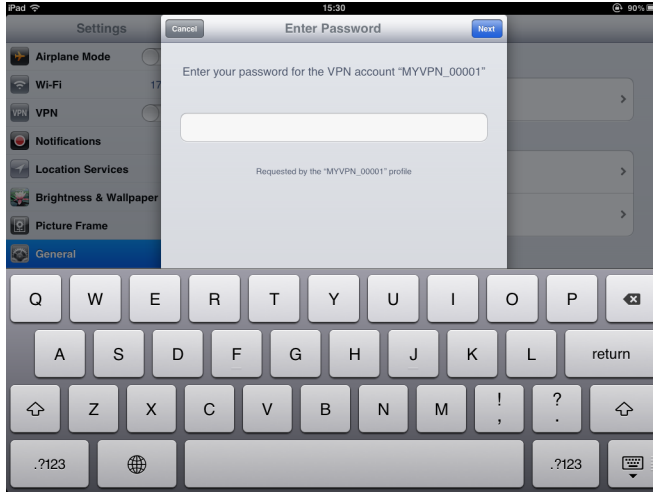

- ! For security reasons we recommend that you do **not** save the VPN access password on the device, but that you enter it each time you wish to connect.

- The VPN profile is now fully installed on your iOS device and is ready for setting up a VPN connection to your company network. Confirm that the installation has been concluded by clicking on the **Complete** button.

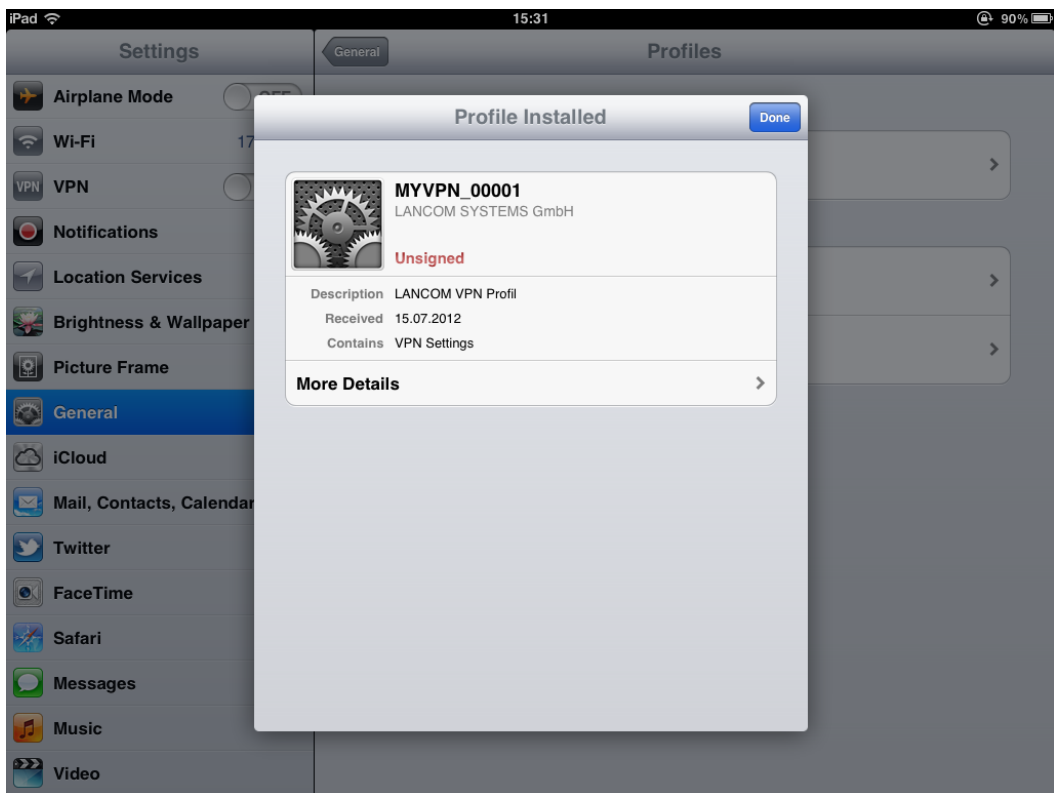



Once installed on an iOS device, the LANCOM VPN device disables the installation routine for this myVPN profile. You can check your status with LANconfig by navigating to the configuration area **VPN > myVPN** and viewing the **myVPN accounts** list:

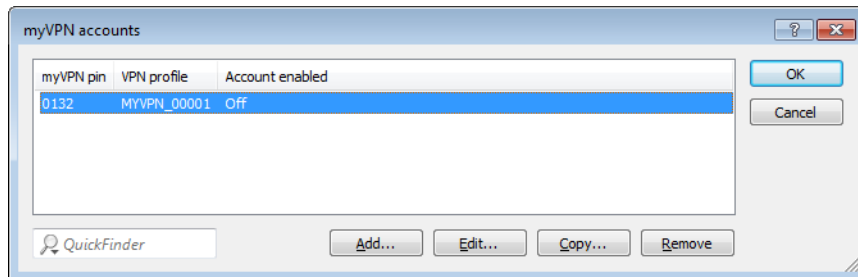

! By disabling the myVPN profile, other iOS devices are prevented from installing the same myVPN profile and thus using the same VPN access credentials. However, disabling the myVPN profile has no effect on the VPN connection itself.

### Opening and closing the VPN connection on the iOS device

After you have installed the VPN profile on your iOS device with the LANCOM myVPN app, you open and close the VPN connection to your company network as follows:

1. Enable the VPN tunnel in the configuration area **Settings** under the option **VPN**.
2. The following dialog already displays the user name from the myVPN profile. Enter the password for the VPN connection and confirm with **OK**.

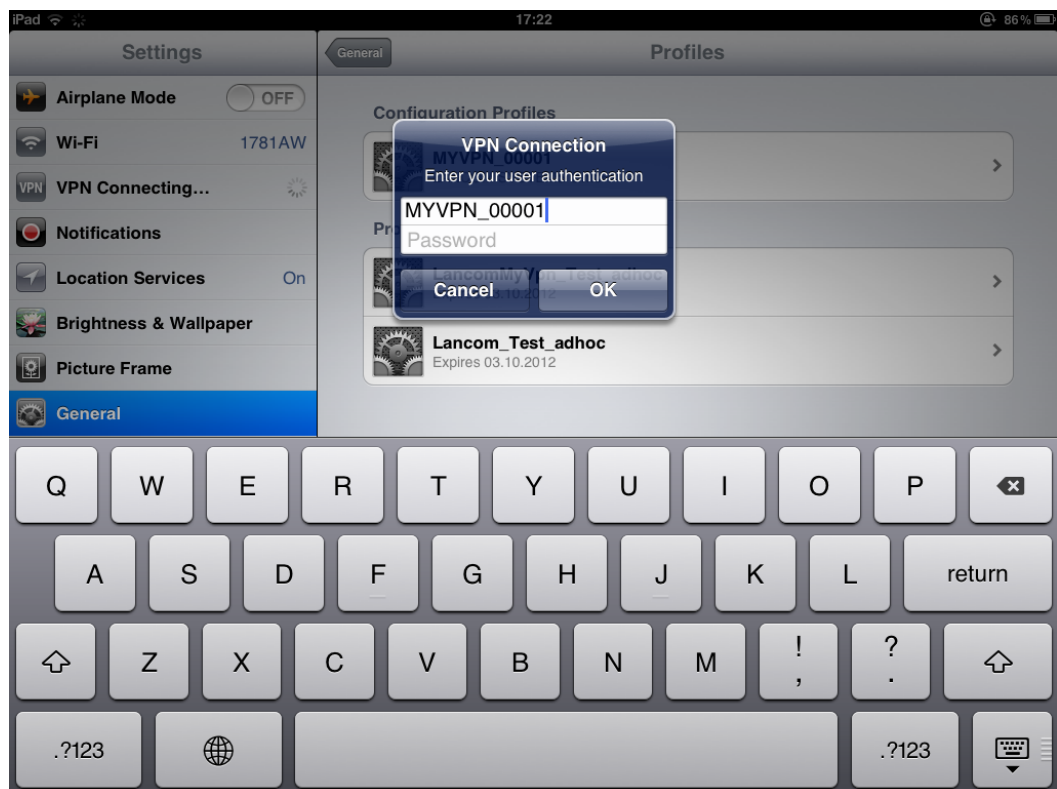

! By default, the password for the VPN connection is the PIN for the myVPN profile.

! The password does not have to be entered if you entered it while installing the myVPN profile for the VPN connection. In this case, this window is not displayed, and the connection will be established immediately.

3. Close the VPN connection on your iOS device in the configuration area **Settings** under the option **VPN**.

### Deleting a VPN profile from the iOS device

To delete the VPN profile from your iOS device:

1. Navigate to **Settings** > **General** > **Profiles** to the list of available profiles on your iOS device.
2. Select the profile, click on **Delete** and confirm the action again in the next dialog with **Delete**.

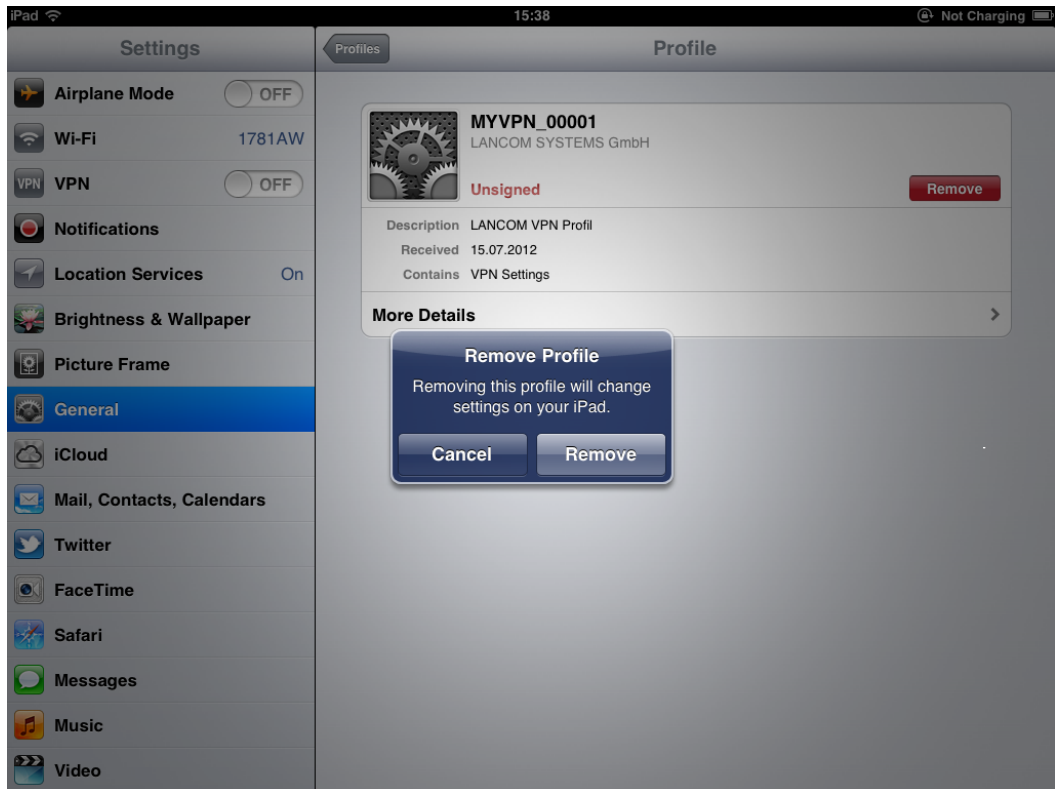

## Enhancements to LANconfig

### Configuring the LANCOM myVPN app

Under **VPN > myVPN** you can manually adjust the settings for the LANCOM myVPN app.

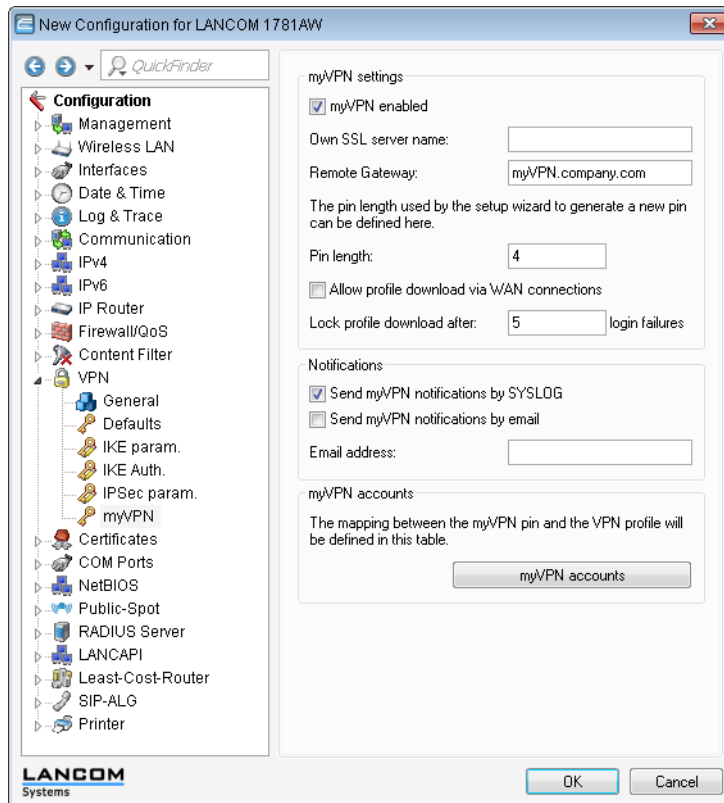

Check the **myVPN enabled** box to allow the LANCOM myVPN app to load a VPN profile.

Specify the **Device name** here if a trusted SSL certificate is installed on this device. This ensures that the IOS device does not issue a warning about an untrusted certificate when the profile is retrieved.

Use the field **Remote gateway** to enter the WAN address of the router or its name as resolved by public DNS servers. If not found automatically, enter the remote gateway into the LANCOM myVPN app.

Specify the **PIN length** to be used by the setup wizard for generating new PINs (default = 4).

You can allow or prevent the **profile download via WAN connections**.

You can limit the number of login failures accepted by the myVPN app in the field **Lock profile download after**.

Activate the option **Send myVPN notifications by SYSLOG** to send messages about the myVPN app to SYSLOG.

Activate the option **Send myVPN notifications by e-mail** to send messages about the myVPN app to a specified e-mail address.

These messages include:

- Successful profile retrieval
- Disabled login for LANCOM myVPN due to too many failed attempts
- Re-enabling of the login (irrespective of whether this is done manually or if the specified time period has expired)

Specify the **E-mail address** to which messages about the LANCOM myVPN app are to be sent.

 E-mail must be configured on the VPN device.

The item **myVPN accounts** is used to assign the myVPN PIN to the VPN profiles.

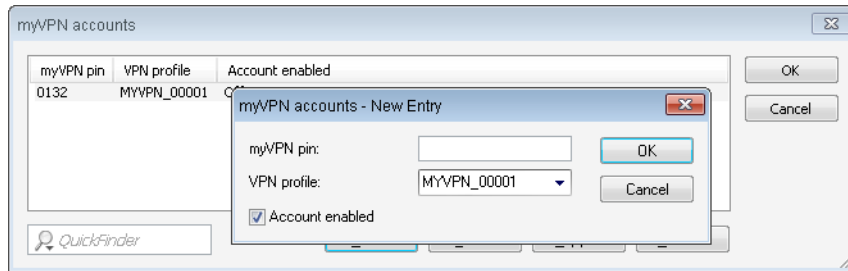

Here you determine which **VPN profile** is to supply data to the myVPN app upon retrieval of the profile.

You set the myVPN PIN that is to be entered when the LANCOM myVPN app is to retrieve the profile.

**! Security notice:** As a security feature of myVPN, the repeated incorrect entry of a PIN causes the device to temporarily disable profile retrieval, and a notification is sent by SYSLOG and by e-mail. After three failed attempts, the device disables profile retrieval for 15 minutes. After five further failed attempts, profile retrieval is disabled for a day. In case of further failed attempts, the time periods vary. Manually releasing this lock resets the corresponding counter. Please also be aware that an attempt to retrieve the profile while access is deactivated (e. g. when the profile has previously been retrieved successfully) is also considered by the device to be a failed attempt.

You activate the profile by checking the **Account enabled** box.

**! After the profile has been retrieved successfully, the device automatically disables the corresponding profile to avoid the repeated download by another device.**

Once you save these settings to the device, the myVPN module is active on the selected VPN device. On your iOS device, you can now start the LANCOM myVPN app and enter the PIN to retrieve the VPN profile.

## Additions to the menu system

### myVPN

The "myVPN" function is used by devices with the iOS operating system to automatically retrieve VPN profiles and take over the configuration of the internal VPN client. You configure the VPN profile and the parameters for myVPN on the router. With the aid of the LANCOM myVPN app and a suitable PIN, you can configure your device for VPN connection in just a few easy steps.

More information on the myVPN app is available on the [LANCOM homepage](#).

#### SNMP ID:

2.19.28

#### Telnet path:

Telnet path: Setup > Vpn > myVPN

#### Operating

Use this switch to activate myVPN for this device.

#### SNMP ID:

2.19.28.1

#### Telnet path:

Telnet path: Setup > Vpn > myVPN

**Possible values:**

Yes

No

**Default:**

No

**PIN length**

This item sets the length of new PINs generated by the setup wizard.

**SNMP ID:**

2.19.28.2

**Telnet path:****Telnet path:Setup > Vpn > myVPN****Possible values:**

Maximum length: 12

Minimum length: 4

**Default:**

4

**Device hostname**

Enter the device name here if a trustworthy SSL certificate is installed on this device. This ensures that the iOS device does not issue a warning about an untrusted certificate when the profile is retrieved.

**SNMP ID:**

2.19.28.3

**Telnet path:****Telnet path:Setup > Vpn > myVPN****Possible values:**

Max. 31 characters from

0-9

a-z

A-Z

#@[{}~!\$%&amp;'()\*+,-./:;&lt;=&gt;?[\\]^\_`

**Default:**

Blank

**Mapping**

This table assigns the myVPN PIN to the VPN profiles.

**SNMP ID:**

2.19.28.4

**Telnet path:****Telnet path:Setup > Vpn > myVPN**

## PIN

This is where you can store the PIN for retrieving the myVPN app profile.

The myVPN setup wizard also uses this PIN in the PPP list for the actual VPN login. If you change your PIN here, you must also change it in LANconfig under **Communication > Protocols > PPP-list** if you wish to avoid having a different PIN.

**!** **Security notice:** As a security feature of myVPN, the repeated incorrect entry of a PIN causes the device to temporarily disable profile retrieval, and a notification is sent by SYSLOG and by e-mail. After three failed attempts, the device disables profile retrieval for 15 minutes. After three further failed attempts the device disables profile retrieval for 24 hours. In case of further failed attempts, the time periods vary. Manually releasing this lock resets the corresponding counter. Please also be aware that an attempt to retrieve the profile while access is deactivated (e. g. when the profile has previously been retrieved successfully) is also considered by the device to be a failed attempt.

### SNMP ID:

2.19.28.4.1

### Telnet path:

**Telnet path:**Setup > Vpn > myVPN > Mapping

### Possible values:

Max. 12 digits from 1234567890

### Default:

Blank

## VPN profile

This setting determines which VPN profile the myVPN app should retrieve.

### SNMP ID:

2.19.28.4.2

### Telnet path:

**Telnet path:**Setup > Vpn > myVPN > Mapping

### Possible values:

16 characters from

0-9

a-z

A-Z

@[{}~!\$%&'()+-./:;<=>?[ \]^\_.

### Default:

Blank

## Active

This switch activates the profile retrieval by means of the myVPN app. After the profile has been retrieved successfully, the device automatically disables the corresponding profile to avoid the repeated download by another device.

### SNMP ID:

2.19.28.4.3

**Telnet path:**

**Telnet path:**Setup > Vpn > myVPN > Mapping

**Possible values:**

No

Yes

**Default:**

No

**Re-enable login**

The command `do re-enable-login` releases the lock that was caused by failed attempts. If required, this generates a message about the re-enabling via SYSLOG or e-mail.

**SNMP ID:**

2.19.28.5

**Telnet path:**

**Telnet path:**Setup > Vpn > myVPN

**E-mail notification**

Enable this option to send messages about the myVPN app to a specific e-mail address. These messages include:

- Successful profile retrieval
- Disabled login for myVPN due to too many failed attempts
- Re-enabling of the login (irrespective of whether this is done manually or if the specified time period has expired)

**SNMP ID:**

2.19.28.6

**Telnet path:**

**Telnet path:**Setup > Vpn > myVPN

**Possible values:**

No

Yes

**Default:**

No

**E-mail address**

Specify the e-mail address to which messages about the myVPN app are to be sent.

**SNMP ID:**

2.19.28.7

**Telnet path:**

**Telnet path:**Setup > Vpn > myVPN

**Possible values:**

Max. 63 characters from

0-9

a-z

A-Z

@[]~!\$%&'()+,./:;<=>?[\]^\_`

**Default:**

Blank

**SYSLOG**

Enable this option to send messages about the myVPN app to SYSLOG. These messages include:

- Successful profile retrieval
- Disabled login for myVPN due to too many failed attempts
- Re-enabling of the login (irrespective of whether this is done manually or if the specified time period has expired)

**SNMP ID:**

2.19.28.8

**Telnet path:**

**Telnet path:**Setup > Vpn > myVPN

**Possible values:**

No

Yes

**Default:**

No

**Remote gateway**

Here you enter the WAN address of the router or its name as resolved by public DNS servers. If the myVPN app cannot find the remote gateway by means of automatic search, you should enter the gateway into the app as well.

**SNMP ID:**

2.19.28.9

**Telnet path:**

**Telnet path:**Setup > Vpn > myVPN

**Possible values:**

Max. 63 characters from

0-9

a-z

A-Z

#@[{}~!\$%&'()+,./:;<=>?[\]^\_`

**Default:**

Blank

**Error count for login block**

This parameter limits the number of failed logins for the myVPN application.

If the user exceeds the maximum number of failed attempts, the device will lock access for 15 minutes the first time, and for 24 hours the second time.

The console command `Re-enable-login` removes these blocks (see [Re-enable login](#)).



**SNMP ID:**

2.19.28.10

**Telnet path:****Setup > Vpn > myVPN****Possible values:**

5-30

**Default:**

5

**Allow access from WAN**

This parameter allows or prevents the user from downloading myVPN profiles from the WAN.

**SNMP ID:**

2.19.28.11

**Telnet path:****Setup > Vpn > myVPN****Possible values:**

Yes

No

**Default:**

Yes

## 11.18.6 Intelligent precalculation of DH keys

The negotiation of a VPN connection is based on the creation of keys according to the Diffie-Hellman method. Depending on the key length, however, calculating a DH key can take some time. If a VPN gateway with 100 VPN connections temporarily loses its Internet connection, recalculating these 100 DH keys may take a while before all of the VPN clients can establish a connection to the VPN gateway again.

With the precalculation of DH keys, the device can accelerate the renegotiation of VPN connections:

The precalculation of keys has a low priority. When the CPU of the device is not busy with other, higher priority tasks, it builds up a stock of public DH keys.

### Additions to the Setup menu

**VPN**

This menu contains the configuration of the Virtual Private Network (VPN).

**SNMP ID:**

2.19

**Telnet path:****Setup****Isakmp**

This menu contains the configuration of the Isakmp.

**SNMP ID:**

2.19.3

**Telnet path:****Setup > VPN****DH groups**

This menu contains the configuration for the precalculation of DH keys.

**SNMP ID:**

2.19.3.29

**Telnet path:****Setup > VPN > Isakmp**

## Precalculation

This option enables or disables the precalculation of DH keys.

**SNMP ID:**

2.19.3.29.1

**Telnet path:****Setup > VPN > Isakmp > DH-Groups****Possible values:**

Yes

No

**Default:**

Yes

## Group config

This table specifies the number of DH keys to calculate for each DH group.

**SNMP ID:**

2.19.3.29.2

**Telnet path:****Setup > VPN > Isakmp > DH-Groups**

## DH group

This value indicates the corresponding DH group.

**SNMP ID:**

2.19.3.29.2.1

**Telnet path:****Setup > VPN > Isakmp > DH-Groups > Group-config****Possible values:**

1

2

5

14

**Default:**

A DH group is fixed for each line.

**Precalculation target**

This value specifies the number of DH keys to be calculated for this DH group.



If you don't specify a value here but you have enabled precalculation, the device will take the number from the policies stored in the SPD table (Security Policy Definitions).

**SNMP ID:**

2.19.3.29.2.2

**Telnet path:**

**Setup > VPN > Isakmp > DH-Groups > Group-config**

**Possible values:**

Max. 9 characters from

0123456789

**Default:**

0

## 11.18.7 Additions to the Setup menu

**VPN**

This menu contains the configuration of the Virtual Private Network (VPN).

**SNMP ID:**

2.19

**Telnet path:**

**Setup**

**Aggressive mode IKE group default**

This IKE group is used for aggressive-mode connections when the remote address cannot be identified by its IP address but by a subsequently transmitted ID.

**SNMP ID:**

2.19.11

**Telnet path:**

**Setup > VPN**

**Possible values:**

1: MODP-768

2: MODP-1024

5: MODP-1536

14: MODP-2048

**Default:**

2: MODP-1024

**Main mode IKE group default**

This IKE group is used for main-mode connections when the remote address cannot be identified by its IP address but by a subsequently transmitted ID.

**SNMP ID:**

2.19.14

**Telnet path:**

**Setup > VPN**

**Possible values:**

1: MODP-768

2: MODP-1024

5: MODP-1536

14: MODP-2048

**Default:**

2: MODP-1024

**Quick mode PFS group default**

This IPsec group is used for simplified dial-in with certificates.

**SNMP ID:**

2.19.20

**Telnet path:**

**Setup > VPN**

**Possible values:**

0: No PFS

1: MODP-768

2: MODP-1024

5: MODP-1536

14: MODP-2048

**Default:**

2: MODP-1024

**Layer**

Define other parameters for the individual VPN connections here.

**SNMP ID:**

2.19.7

**Telnet path:**

**Setup > VPN**

**PFS group**

Perfect Forward Secrecy (PFS) is a security feature of encryption algorithms. The PFS group specifies the length of the Diffie-Hellman key used to encrypt the IKE negotiation.

**SNMP ID:**

2.19.7.3

**Telnet path:****Setup > VPN > Layer****Possible values:**

0: No PFS

1: MODP-768

2: MODP-1024

5: MODP-1536

14: MODP-2048

**Default:**

2: MODP-1024

**IKE group**

The IKE group specifies the length of the Diffie-Hellman key used to encrypt the IKE negotiation.

**SNMP ID:**

2.19.7.4

**Telnet path:****Setup > VPN > Layer****Possible values:**

1: MODP-768

2: MODP-1024

5: MODP-1536

14: MODP-2048

**Default:**

2: MODP-1024

## 11.18.8 Enhancements to LANconfig

### Selecting the IKE group in LANconfig

In LANconfig, the settings for the default IKE groups are located under **VPN > Defaults**:

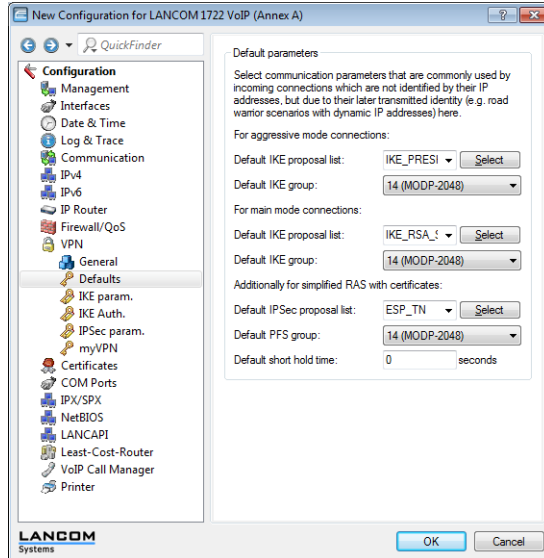

In LANconfig, the settings for the default IKE groups for VPN connections are located under **VPN > General > Connection parameters**:

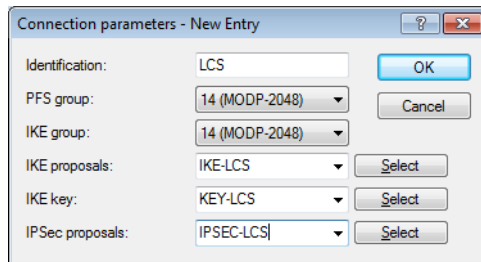

## 11.19 Addition(s) to LCOS 8.82

### 11.19.1 Hash function SHA2-256 selectable via LANconfig

As of LCOS version 8.82, you can also select the hash algorithm SHA2-256 for IKE and IPsec proposals over LANconfig for devices that are equipped appropriately.

#### An overview of LANCOM VPN

##### Functions of LANCOM VPN

This section lists all of the functions and properties of LANCOM VPN. Experts in the VPN sector are offered a highly compressed summary of the performance of the function. Understanding the terminology requires a sound knowledge of the technical fundamentals of VPN. However, for commissioning and normal operation of the LANCOM VPN, this information is not required.

- VPN according to IPSec standard
- VPN tunnel via leased lines, switched connections and IP networks
- IKE Main and Aggressive mode
- LANCOM Dynamic VPN: Public IP addresses can be static or dynamic (establishing a connection with remote sites using dynamic IP addresses requires ISDN)
- IPSec protocols ESP, AH and IPCOMP in transport and Tunnel mode
- Hash algorithms:
  - HMAC-MD5-96, hash length 128 bits
  - HMAC-SHA-1-96, hash length 160 bits
  - HMAC-SHA-2-256, hash length 256 bits
- Symmetrical encryption methods
  - AES, key lengths of 128, 192 and 256 bits
  - Triple DES, Key length 168 bits
  - Blowfish, key length 128 - 448 bits
  - CAST, key length 128 bits
  - DES, key length 56 bits
- Compression with "Deflate" (ZLIB) and LZS
- IKE config mode
- IKE with preshared keys
- IKE with RSA signature and digital certificates (X.509)
- Key exchange via Oakley, Diffie-Hellman algorithm with a key length of 768 bits, 1024 bits, 1536 bits and 2048 bits (well known groups 1, 2, 5 und 14)
- Key management according to ISAKMP

## Additions to the Setup menu

### IKE authentication algorithm

Hash algorithm for the encryption

**SNMP ID:**

2.19.4.11.4

**Telnet path:**

**Setup > VPN > Proposals > IKE**

**Possible values:**

MD5

SHA1

SHA2-256

**Default:**

MD5

### ESP authentication algorithm

ESP authentication method for this proposal

**SNMP ID:**

2.19.4.12.5

**Telnet path:**

**Setup > VPN > Proposals > IPSEC**

**Possible values:**

No authentication

HMAC-MD5

HMAC-SHA1

HMAC-SHA2-256

**Default:**

No authentication

**AH authentication algorithm**

AH authentication method for this proposal

**SNMP ID:**

2.19.4.12.6

**Telnet path:**

**Setup > VPN > Proposals > IPSEC**

**Possible values:**

No authentication

HMAC-MD5

HMAC-SHA1

HMAC-SHA2-256

**Default:**

No authentication



## 12 Virtual LANs (VLANs)

### 12.1 What is a Virtual LAN?

The increasing availability of inexpensive layer 2 switches enables the setup of LANs much larger than in the past. Until now, smaller parts of a network had been combined with hubs. These individual segments (collision domains) had been united via routers to larger sections. Since a router represents always a border between two LANs, several LANs with own IP address ranges arose by this structure.

By using switches, it is possible to combine much more stations to one large LAN. By the specific control of data on the individual ports, the available bandwidth can be utilized much better than by using hubs, and the configuration and maintenance of routers within the network can be omitted.

But also a network structure based on switches has disadvantages:

- Broadcasts are sent like hubs over the entire LAN, even if the respective data packets are only important for a certain segment of the LAN. A sufficient number of network stations can thus lead to a clear reduction of the available bandwidth in the LAN.
- The entire data traffic on the physical LAN is "public". Even if single segments are using different IP address ranges, each station of the LAN is theoretically able to tap data traffic from all logical networks on the Ethernet segment. The protection of individual LAN segments with Firewalls or routers increases again the requirements to network administration.

One possibility to resolve these problems are virtual LANs (VLANs), as described in IEEE 802.1p/q. By this concept, several virtual LANs are defined on a physical LAN, which do not obstruct each other, and which also do not receive or tap data traffic of the respective other VLANs on the physical Ethernet segment.

### 12.2 This is how a VLAN works

By defining VLANs on a LAN the following goals should be achieved:

- Data traffic of certain logical units should be shielded against other network users.
- Broadcast traffic should also be reduced to logical units, not bearing a burden on the entire LAN.
- Data traffic of certain logical units should be transmitted with a specific priority compared to other network users.

An example to clarify: A switch is connected to a hub within a LAN, which connects four stations from the marketing department to the network. One server and two stations of the accounting department are directly connected to the switch. The last section is the base station of a wireless network, where four WLAN clients reside from the sales department.

The stations from marketing and sales should be able to communicate with each other. Additionally, they should be able to access the server. The accounting department needs also access to the server, but should otherwise be shielded against the other stations.

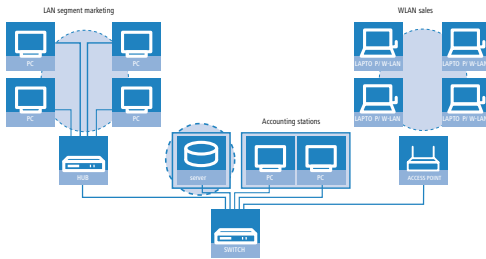

### 12.2.1 Frame tagging

In order to shield or, if necessary, to priorities data traffic of a virtual LAN against the other network users, data packets must have an additional feature (a "tag"). That's why the respective process is also called "frame tagging".

Frame tagging must be realized such that the following requirements are fulfilled:

- Data packets with and without frame tagging must be able to exist in parallel on a physical LAN.
- Stations and switches in a LAN, which do not support VLAN technology, must ignore the data packets with frame tagging and/or treat them as "normal" data packets.

The tagging is realized by an additional field within the MAC frame. This field contains two important information for the virtual LAN:

- VLAN ID: A unique number describes the virtual LAN. This ID defines the belonging of data packets a logical (virtual) LAN. With this 12 bit value it is possible to define up to 4094 different VLANs (VLAN IDs "0" and "4095" are reserved resp. inadmissible).

⚠ VLAN ID "1" is used by many devices as the Default VLAN ID. Concerning unconfigured devices, all ports belong to this Default VLAN. However, this assignment can also be changed by configuration.

- Priority: The priority of a VLAN-tagged data packet is indicated by a 3 bit value. "0" represents the lowest priority, "7" the highest one. Data packets without VLAN tag are treated with priority "0".

This additional field makes the MAC frames longer than actually allowed. These "overlong" packets can only be recognized and evaluated by VLAN-capable stations and switches. Frame tagging incidentally leads to the desired behavior for network users without VLAN support:

- Switches without VLAN support simply pass on these data packets and ignore the additional fields within the MAC frame.
- Stations without VLAN support are not able to recognize the protocol type due to the inserted VLAN tag and discard the packets silently.

⚠ Older switches in the LAN are perhaps not able to pass on correctly the overlong frames between the individual ports and will reject the tagged packets.

### 12.2.2 Conversion within the LAN interconnection

Certain stations shall be grouped to logical units by virtual LANs. But the stations themselves are usually neither able to generate the required VLAN tags, nor able to handle them.

Data traffic between network users always runs over different interfaces of the distributors in the LAN. These distributors (switches, base stations) have got the task to insert VLAN tags according to the desired application into the data packets, to evaluate them and, if necessary, to remove them again. Because logical units are each connected to different interfaces of the distributors, the rules for generating and processing of the VLAN tags are assigned to the single interfaces.

Coming back again to the first example:

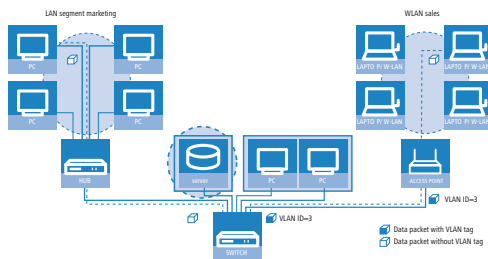

A workstation from the marketing sends a data packet to a workstation of the sales department. The marketing hub passes the packet simply on to the switch. The switch receives the packet at its port no. 1, and recognizes that this port belongs to a VLAN with the VLAN ID "3". It inserts an additional field into the MAC frame with the appropriate VLAN tag, and issues the packet only on ports (2 and 5), which also belong to VLAN 3. The base station of the sales department will receive the packet on its LAN interface. By its settings, the base station can recognize that the WLAN interface belongs also to VLAN 3. It will remove the VLAN tag from the MAC frame, and issues the packet again on the wireless interface. The WLAN client can handle the packet then, which has a "usual" length again, like each other data packet without VLAN tagging.

### 12.2.3 VLAN Q-in-Q tagging

VLANs compliant with IEEE802.1q are generally used to connect multiple networks that share a common physical medium but which are to be kept separate from one another. In some cases VLANs are operated on public networks that are operated by providers in order to keep the various company networks separate. Consequently VLAN tags may be used both in the LAN and over the WAN path—VLAN tagged LAN packets therefore require an additional VLAN tag for transmission over WAN. For control over VLAN tagging, the actions performed by each port can be defined separately.

### 12.2.4 Application examples

Main application of virtual LANs is to install different logical networks on a physical Ethernet segment, whose data traffic is protected against the other logical networks.

The following sections present examples for the operation of virtual LANs on behalf of this background.

#### Management and user traffic on a LAN

Several hot spots are installed on an university campus, so that students equipped with notebooks and WLAN cards have access to the Internet and to the server of the library. The hot spots are connected to the university LAN. Via this LAN the administrators also access the base stations to carry out several management tasks via SNMP.

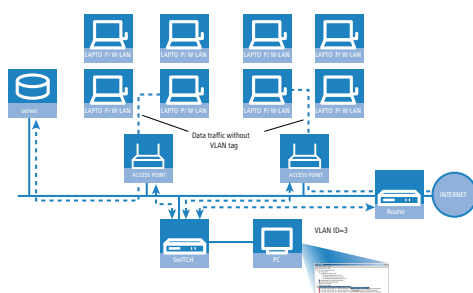

By setting up a virtual LAN between the base stations and the administrator's switch, management data is shielded against all "public" traffic on the LAN.

### Different organizations on one LAN

The flexibility of the modern world of work raises new challenges for administrators concerning planning and maintenance of network structures. The occupation of the rooms by leaseholders changes permanently in public office buildings, and also inside of a company, teams are often newly assembled. In both cases, the individual units must have an independent, protected LAN. But this task is very burdensome to realize by hardware changes, or even not at all, because e.g. only one single central cabling exists in the office building.

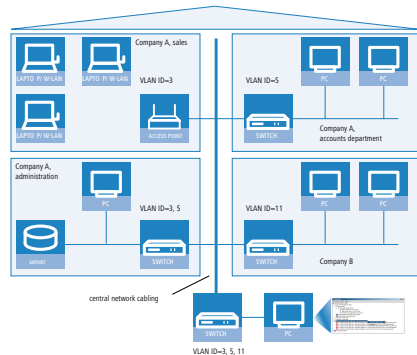

Virtual LANs enable to perform this task in a very smart way. Also when departments or companies change at a later time inside of the building, the network structure can be easily adjusted.

All network users in this example use the central Ethernet, which is, like the connected devices, supervised by a service provider. Company A has three departments on two floors. The sales department can communicate with the administration department via VLAN ID 3, the accounts department with the administration via VLAN ID 5. The networks of accounts department and sales do not see each other. Company B is also shielded by VLAN ID 11 against all other networks, only the service provider can access all devices for maintenance purposes.

## 12.3 Configuration of VLANs

The configuration of LANCOM Router devices within the VLAN realm has to perform two important tasks:

- Defining virtual LANs and assigning them a name, a VLAN ID and the affected interfaces.
- Defining for the interfaces how to proceed with data packets with or without VLAN tags.

### 12.3.1 VLAN and ARF

In some cases it can suffice to configure the VLAN settings on the basis of the IP network (Advanced Routing and Forwarding, ARF). Here, a VLAN ID is defined for an IP network. All outbound packets from this network are tagged with this VLAN ID. Incoming packets have to be tagged with this VLAN ID in order for them to be assigned to the network. Please observe the relevant instructions in the section on ARF.

### 12.3.2 VLAN and WLAN Controllers

For large scale applications, LANCOM Access Points and LANCOM Wireless Routers can be managed from a central WLAN-Controller. The WLAN-Controller handles the definition of the wireless LAN networks (SSIDs) and it can assign a VLAN ID to these SSIDs. By assigning a VLAN ID to an SSID on the WLAN-Controller and the activation of the management VLAN (ID greater than 0), the VLAN module on the managed Access Point is activated automatically. Please also observe the instructions in the section on central WLAN management.

### 12.3.3 General settings

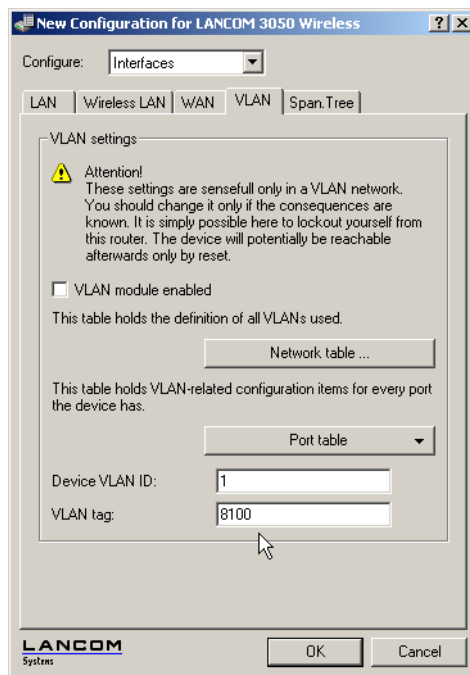

LANconfig: interfaces / VLAN

WEBconfig: LCOS menu tree / Setup / VLAN

#### To activate the VLAN module

You should only activate the VLAN module, if you are familiar with the effects of using VLAN.

 Wrong VLAN settings can obviate the access to the configuration of the device.

#### VLAN tagging mode

When transmitting VLAN tagged networks via provider networks that use VLAN themselves, providers sometimes use special VLAN tagging IDs. In order to set VLAN transmission on the LANCOM to accommodate this, the Ethernet2 type of the VLAN tag can be set as a 16-bit hexadecimal value as 'tag value' under `Setup/LAN Bridge/VLAN` or in LANconfig in the configuration area under 'Interfaces' using the 'VLAN' tab in the field 'VLAN tag'. The default is '8100' (802.1p/q VLAN tagging) other typical values for VLAN tagging could be '9100' or '9901'

### 12.3.4 The networktable

In the network table are those virtual LANs defined, in which the LANCOM should participate.

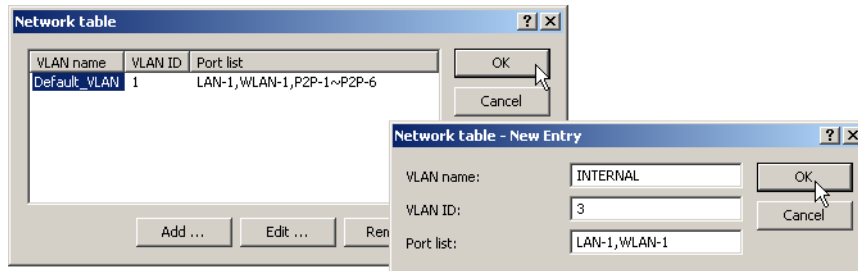

LANconfig: Interfaces / VLAN / VLAN table

WEBconfig: LCOS menu tree / Setup / VLAN / network table

- **Name:** The VLAN name serves only as a description during configuration. This name is used at no other place.
- **VLAN ID:** This number marks the VLAN unambiguously. Possible values range from 1 to 4094.
- **Port list:** All LANCOM interfaces belonging to the VLAN are entered into this list. Given a device with a LAN interface and a WLAN port, e.g. ports "LAN-1" and "WLAN-1" can be entered. In case of port ranges, the individual ports must be separated by a tilde: "P2P-1~P2P-4".

! The first SSID of the first WLAN modul is named WLAN-1, the other SSIDs are WLAN-1-2 up to WLAN-1-8. If the device has two WLAN moduls the SSIDs are WLAN-2, WLAN-2-2 up to WLAN-2-8.

### 12.3.5 The port table

The port table configures the individual ports of the device for use by the VLAN. The table has got an entry for each port of the device with the following values:

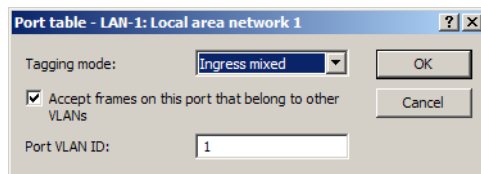

LANconfig: Interfaces / VLAN / Port table

WEBconfig: LCOS menu tree / Setup / VLAN / Port table

- **Port:** Name of the port, not editable.
- **Tagging mode**

Controls the processing and assignment of VLAN tags at this port.

- **Never:** Outbound packets are not given a VLAN tag at this port. Incoming packets are treated as though they have no VLAN tag. If incoming packets have a VLAN tag, it is ignored and treated as though it were part of the packet's payload. Incoming packets are always assigned to the VLAN defined for this port.
- **Unconditional:** Outgoing packets at this port are always assigned with a VLAN tag, irrespective of whether they belong to the VLAN defined for this port or not. Incoming packets must have a VLAN tag, otherwise they will be dropped.

- Mixed: Allows mixed operation of packets with and without VLAN tags at the port. Packets without a VLAN tag are assigned to the VLAN defined for this port. Outgoing packets are given a VLAN tag unless they belong to the VLAN defined for this port.
- Ingress-mixed: Arriving (ingress) packets may or may not have a VLAN tag; outbound (egress) packets are never given a VLAN tag.
- Default: Ingress mixed

- **Allow all VLANs (allows packets from other VLANs to enter this port)**

This option defines whether tagged data packets with any VLAN ID should be accepted, even if the port is not a "member" of this VLAN.

- **Port VLAN ID**

This port ID has two functions:

- Untagged packets received at this port in 'Mixed' or 'Ingress-mixed' mode are assigned to this VLAN, as are all ingress packets received in 'Never' mode.
- In the 'Mixed' mode, this value determines whether outgoing packets receive a VLAN tag or not: Packets assigned to the VLAN defined for this port are given **no** VLAN tag; all others are given a VLAN tag.

## 12.4 Configurable VLAN IDs

### 12.4.1 Different VLAN IDs per WLAN client

VLANs are usually connected to a LAN interface on the LANCOM. Therefore, all packets that pass through this interface receive the same VLAN ID when the VLAN module is enabled. However, in some cases, administrators will want to assign different WLAN users to different VLANs.

LANconfig: Wireless-LAN / Stations / Stations

WEBconfig: LCOS menu tree / Setup / WLAN / Access-List

The client-specific VLAN ID can take on values from 0 to 4094. The default value of '0' stands for an unspecified VLAN ID. In such a case, the client will be assigned to the VLAN port of the logical WLAN.

The following requirements must be met in order to ensure successful client-specific VLAN assignment:

- VLAN operation must be enabled.
- The VLAN IDs that are to be assigned to the individual clients must be included in the VLAN network table.
- The LAN interfaces and all WLAN interfaces that are used by the clients must be assigned to the corresponding VLAN.

## 12.4.2 VLAN tags for DSL interfaces

Some DSL networks use VLAN tags in the same way as they are used in local networks to differentiate between logical networks on shared transmission media. The LANCOM Router can process these VLAN tags correctly if a VLAN ID is defined for each DSL remote site.

LANconfig: Communication / Remote sites / Remote sites (DSL)

WEBconfig: LCOS menu tree / Setup / WAN / DSL Broadband Peers

- VLAN ID

ID used to explicitly identify the VLAN over the DSL connection.

## 12.4.3 Special VLAN ID for DSLoL interfaces

In order to better separate the data traffic on a DSLoL interface from other traffic, 'VLAN ID' can be set up for the DSLoL interface under *Setup / Interfaces / DSLoL* or in LANconfig in the configuration area 'Interfaces' using the 'WAN' tab under the interface settings for the DSLoL interface.

## 12.5 VLAN tags on layer 2/3 in the Ethernet

### 12.5.1 Introduction

VLAN tags enable a simple form of QoS control even when using switches that cannot evaluate IP headers. The IEEE 802.1p standard defines a priority tag in the VLAN header with a length of 3 bits, which correspond to the first 3 bits of the DSCP fields (Differentiated Services Code Point - DiffServ) and/or the precedence in the TOS field (Type of Service). The processing of VLAN tagged packets requires that packets in the receive direction are regarded differently to packets in the send direction.



- Upon receipt of a tagged Ethernet packet, it may be processed in one of three ways:
  - The VLAN tag is ignored.
  - The VLAN tag is always copied to the DiffServ or TOS field.
  - The VLAN tag is copied to the DiffServ or TOS field if this is not marked already, i.e. the precedence is '000'.
- When a packet is transmitted over Ethernet, the VLAN tag can be set depending on the precedence. This should only happen if the recipient of the tag can understand it, i.e. tagged packets can be received. Tags are thus only set for packets which are sent to addresses from which the LANCOM already received tagged packets.

 When a tagged packet is received, the tag is saved to the associated entry in the connection list. If a packet is to be sent with a precedence setting, then the VLAN ID recorded earlier is entered into the packet together with the precedence to form a VLAN tag. Where a connection causes other connections to be opened, e.g. with FTP or H.323, then the tag is inherited to the new entries.

## 12.5.2 Configuring VLAN tagging on layer 2/3

Configuring VLAN tagging on layer 2/3 involves the definition of the general routing settings and the behavior upon receipt and transmission of tagged packets.

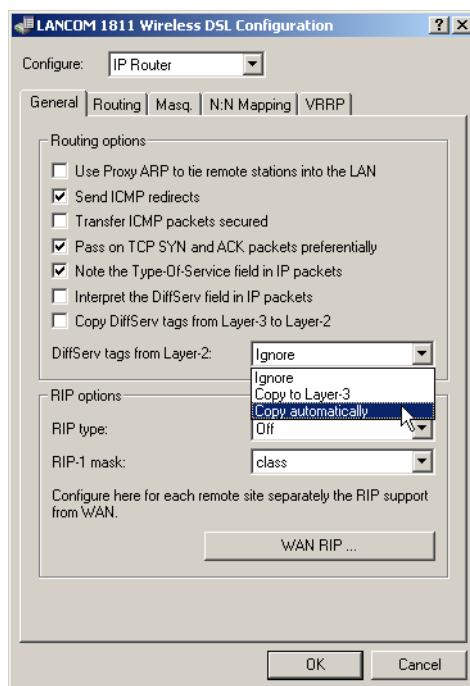

LANconfig: IP Router / General

WEBconfig: LCOS menu tree / Setup / IP-Router / Routing-Method

- Routing method
  - Normal: TOS/DiffServ field is ignored.
  - Type-Of-Service: The TOS/DiffServ field is regarded as a TOS field; the bits 'low delay' and 'high reliability' will be evaluated.
  - DiffServ: The TOS/DiffServ field is regarded as a DiffServ field. After evaluating the precedence, packets with the code points 'AFxx' are saved and packets with the code points 'EF' receive preferential treatment. All other packets are transmitted as normal.
- DiffServ-Tags from Layer-2

The setting for Layer2-Layer3 tagging regulates the behavior when a data packet is received:

- Off: VLAN tags are ignored.
- On: Priority bits in the VLAN tag are always copied to the precedence of the DSCP.
- Automatic: Priority bits in the VLAN tag are only copied to the DSCP precedence if this is '000'.
- To copy DiffServ-Tags from Layer2 to Layer3

The setting for Layer3-Layer2 tagging regulates the behavior when a data packet is transmitted. If this option is activated, VLAN tags with priority bits originating from the DSCP precedence will be generated if the recipient has sent at least one tagged packet.

## 12.6 Addition(s) to LCOS 8.60

### 12.6.1 Group key per VLAN

The following section provides explanations for the management of group keys in the VLAN.

#### Introduction

In a VLAN environment, the central network administration generally assigns a unique VLAN ID to each virtual network. Which VLAN a client belongs to is mostly decided by the physical connection between the client and the network.

The central instance that manages the network (e. g. a VLAN-capable switch) internally assigns its ports to certain VLAN IDs. A data packet arriving at a port is internally passed on only to the ports with the corresponding VLAN IDs. Packets are not sent to the other network nodes that are connected to ports with different (or no) VLAN IDs.

In the case of multiple VLANs that offer various service levels, data communications are channeled through different logical wireless LANs (SSIDs). For example, employees receive access to the corporate network and the Internet via a specific SSID. Guests receive a different SSID that offers access limited to the Internet.

LANCOM access points also maintain VLAN network tables, which control the assignment of wireless LAN clients to individual VLANs. In large network environments, a RADIUS server usually handles the rights management and the assignment of clients to the VLANs. After successful authentication, the RADIUS server returns the data to the corresponding access point. For the duration of the client association, this data is stored in the AP's VLAN network table.

If necessary, the different WLAN clients associated with the same access point obtain different VLAN IDs. This is handled by the dynamic VLAN network tables in the access points. VLAN-internal communication is protected by a session key negotiated when logging onto the access point. This ensures that data communications by clients in different VLANs remain isolated from each other even though the various clients are using the same logical wireless LAN (SSID) to communicate with the access point.

A client associating with an access point in a wireless LAN is also assigned with a group key for the reception of broadcast or multicast messages.

Broadcast and multicast messages do not support VLAN tagging. This is why wireless LAN clients that are located in an isolated VLAN cannot be excluded from receiving these messages. In the ideal case, the wireless clients ignore broadcast and multicast messages from outside the VLAN.

Since these messages are increasingly being used for network configuration, the following problems arise:

- Network protocols such as "UPnP" and "Bonjour" use these messages to announce new services in the network. Theoretically, wireless LAN clients could set up access to servers that they have no access to at all.
- The Internet standard IPv6 uses multicast broadcasting to transmit router information to the clients.

There is a risk that wireless LAN clients from outside the VLAN can use this information to evade access to the VLAN for which they are actually registered.

The widespread use of IPv6 will lead to an increase in this type of client problem.

To avoid these problems, the access point can assign a separate group key to each VLAN, instead of one that applies to all wireless LAN clients. Thus the access point sends its broadcast and multicast transmissions not to all existing wireless clients, but solely to a specific VLAN and the clients registered there. The wireless LAN clients in other VLANs therefore cannot decrypt these broadcasts.

 The IEEE 802.11 standard provides for the administration of 4 different keys. One key is always reserved for the secure unicast communication between the access point and a wireless LAN client.

Thus in principle a maximum of 3 separate VLANs can be managed with their own group keys. Each group key is either managed automatically by the access point or manually by the network administrator. When the wireless LAN client logs on to the network, the access point sends it the corresponding VLAN group key to decrypt the broadcast and multicast transmissions for that VLAN.

This results in 2 possible scenarios:

- No more than 3 VLANs are set up in the area of an access point: These VLANs are securely separated from each other by the 3 VLAN group keys.
- More than 3 VLANs exist within range of an access point: In this case, at least two VLANs share a group key. The administrator must find the optimal distribution of the shared group keys between the VLANs.

VLAN group keys are managed in 2 tables:

- The configuration table in which the assignment is carried out manually by the administrator.
- The status table in which the automatic group key assignment by the access point can be viewed.

## Managing VLAN group keys

If you want to use different VLAN IDs on a single logical wireless LAN network (SSID), you have the option to assign the appropriate group key for broadcast and multicast transmissions. This setting in LANconfig is found under **Wireless LAN > 802.11i/WEP > Extended settings > VLAN group key mapping**

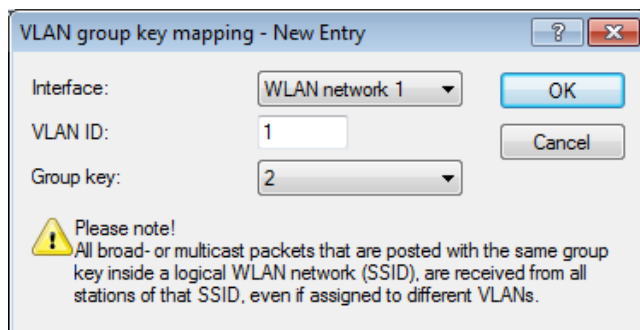

The automatic assignment of group keys is carried out in the following steps:

1. When a wireless LAN client logs on, the access point checks whether its VLAN ID is already listed in the status table and assigned to a group key accordingly.
2. If not, the access point consults the configuration table to check whether there is a manual assignment. Should this be the case, then it creates a mapped entry in this table.
3. If there is no manual assignment either, the access point adds a new entry for this client and assigns the group key with the fewest users.

The status table displaying the current automatic VLAN group key assignments for each SSID can be found at **LCOS menu tree > Status > WLAN > VLAN groupkey mapping**

## Additions to the menu system

### VLAN group key mapping

This table contains the mapping of VLAN group keys to the logical WLAN networks.

**SNMP ID:**

2.12.70

**Telnet path:**

**Setup > WLAN > VLAN-groupkey-mapping**

**Network**

Contains the name of a WLAN network registered in the device.

**SNMP ID:**

2.12.70.1

**Telnet path:**

**Setup > WLAN > VLAN-groupkey-mapping**

**VLAN ID**

Contains the VLAN ID assigned to the logical WLAN network.

**SNMP ID:**

2.12.70.2

**Telnet path:**

**Setup > WLAN > VLAN-groupkey-mapping**

**Possible values:**

1 to 4094

**Default:**

1

**Group key index**

The table contains the group key index:

**SNMP ID:**

2.12.70.3

**Telnet path:**

**Setup > WLAN > VLAN-groupkey-mapping**

**Possible values:**

1 to 3

## 13 Wireless LAN (WLAN)

### 13.1 Introduction

---

 The following sections are a general description of the LCOS operating system functions relating to wireless networks. The functions provided by your specific device are outlined in the manual supplied with it.

This chapter gives you a brief introduction to wireless networking technology. It also provides an overview of the many different applications, fraction and capabilities of LANCOM WLAN devices.

A wireless LAN connects individual end-user devices (PCs and mobile computers) to form a local network (also called – **Local Area Network**). In contrast to a traditional LAN, communication takes place over a wireless connection and not over network cables. For this reason it is referred to as a **Wireless Local Area Network (WLAN)**.

A wireless LAN provides the same functionality as a cable-based network: Access to files, servers, printers etc. as well as the integration of individual work stations into a corporate mail system or access to the Internet.

There are obvious advantages to wireless LANs: Notebooks and PCs can be installed where they are needed—problems with missing connections or structural changes are a thing of the past with wireless networks. Apart from that, wireless LANs can also be used for connections over longer distances. Expensive leased lines and the associated construction measures can be saved.

LANCOM Systems differentiates between two different types of WLAN device, each with its own field of application and consequently offering specialized functions and configuration options.

- LANCOM Access Points are generally used to connect one or more WLANs to a cabled LAN. As such, they merely function as a "bridge" to transfer data to and from the clients. Routing into the Internet or to other remote stations is handled by other network components. LANCOM Access Points generally have just one or more Ethernet interfaces.
- In addition to one or more Ethernet interfaces, LANCOM Wireless Routers are equipped with WAN interfaces for ADSL, DSL and/or ISDN. In a single device, they combine WLAN functions with the task of routing data into the Internet or to other remote stations.

---

 The following sections mostly refer to "access points" as a synonym for both types of device, unless we explicitly differentiate between a LANCOM Wireless Router and a LANCOM Access Point.

LANCOM Wireless Routers and LANCOM Access Points can be operated either as self-sufficient Access Points with their own configuration (WLAN modules in "Access Point mode") or as components in a WLAN infrastructure, which is controlled from a central WLAN-Controller ("managed mode").

### 13.2 Application scenarios

Wireless LAN systems can act as an extension to or even as a replacement for cabled networks. In some cases wireless LANs even provide completely new application possibilities, which can mean a major advance in the way work is organized, or significant cost savings.

- Extensive wireless LANs, possibly connected to a LAN, with one or more access points (infrastructure mode)
- Hotspot or guest access
- Connecting two LANs over a wireless link (point-to-point mode)

## 13 Wireless LAN (WLAN)

- Relay function for connecting networks via multiple access points.
- Connecting devices with an Ethernet interface via an access point (client mode)
- Central management by a LANCOM WLAN Controller (managed mode)
- WDS (Wireless Distribution System)
- Data transfer to mobile objects in industrial environments.
- Transmission of VPN-encrypted connections with VPN pass through
- Simple, direct connection between terminal devices with an access point (ad-hoc mode)

### 13.2.1 Infrastructure mode

In infrastructure mode, WLAN clients connect to a central access point. The access point provides one or more wireless LAN networks. It regulates the client's rights to access the radio cell, communications between the clients, and access to further networks. In larger scale WLAN scenarios (e.g. in companies with offices extending between several buildings or floors) multiple access points can provide WLAN clients with access to a common, shared network. The clients can roam between the different access points, if necessary. A common term used here is "campus coverage" because this solution is used by a large number of colleges and universities to provide students and staff with network access.

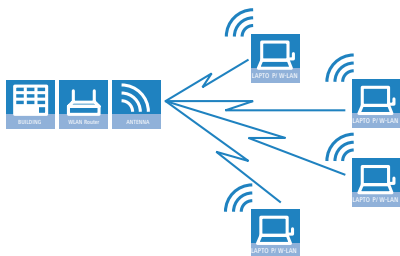

### 13.2.2 Hotspot or guest access

A hotspot is a special variant of the infrastructure mode described above. Whereas the normal infrastructure mode provides the members of a closed user group with access to a network that includes all the necessary services, a hotspot provides network access (generally restricted to Internet only) to wireless LAN clients at a fee. In addition to the differences in Access Point configuration, setting up a hotspot requires authentication, authorization and accounting (AAA) functions such as those provided by e.g. Public Spot options. Hotspots are generally set up at public locations where people have a short-term need to access the Internet, such as at airports, cafés or hotels.

A hotspot provides network access to a WLAN client for a limited time period and without having to configure the access point. This method is often used by companies, for example to provide guests with temporary Internet access.

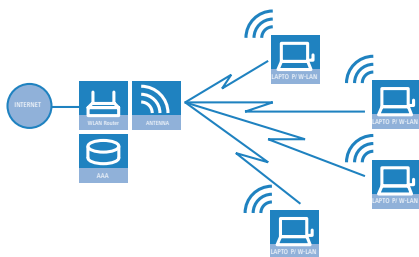

### 13.2.3 Managed mode

The widespread use of wireless Access Points and wireless routers provides great convenience and flexibility in network access for businesses, universities and other organizations. With centralized WLAN management, the Access Points in managed mode are not configured themselves but at a central location, the WLAN-Controller.

The WLAN-Controller authenticates the Access Points and transmits a certificate and the correct configuration to the approved devices. This allows for convenient configuration of the WLAN from a central point and the changes to the configuration affect all of the Access Points simultaneously.

Split management can be used to separate the WLAN configuration from the rest of the router configuration. This allows router settings and VPN settings to be adjusted locally, for example in a branch office or home office installation, and the WLAN configuration is regulated by a LANCOM WLAN Controller at the main office.

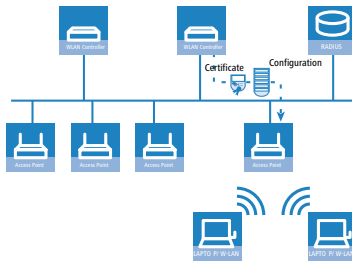

### 13.2.4 WLAN bridge (point-to-point)

Whereas the scenarios discussed so far have involved connecting multiple WLAN clients to one Access Point (point-to-multipoint), outdoor wireless LAN systems are particularly advantageous for providing a link between two Access Points (point to point). By setting up a wireless link between two Access Points, a distant production building on extensive company premises can be very easily integrated into the company network, for example.



A point-to-point connection can also be used in difficult terrain (such as mountainous areas or islands) to provide Internet access in areas where cabling would be too expensive. With a direct line of sight between the two Access Points and a sufficient fresnel zone, distances of several kilometers can be bridged by this type of wireless link.



### 13.2.5 WLAN bridge in relay mode

In some cases, the distance between the two locations to be connected exceeds the range of a single wireless link. This may be the case when the distance between the Access Points exceeds the radio range, or when obstacles exist in the line of site between the two Access Points.

In these cases, the two end points can be connected by stringing together multiple Access Points, each of which has two WLAN modules. Because the intermediate Access Points often operate solely as relay stations, the operating mode of these Access Points is referred to as "relay mode".



Although LANCOM Access Points can run several P2P links simultaneously on each wireless module in addition to supporting wireless LAN clients, for performance reasons we recommended the use of LANCOM Access Points with two wireless modules for the relay stations.

### 13.2.6 WLAN bridge to an access point – managed and unmanaged mixed

WLAN-Controllers managed from a central Access Point are generally connected to the network via cabled Ethernet. Where this is not possible, managed Access Points can be integrated into the LAN via a WLAN bridge, assuming that these are equipped with two WLAN modules. In this scenario, one WLAN module operates as a managed Access Point which obtains its configuration from the central WLAN-Controller. The other WLAN module is permanently configured as a WLAN bridge.

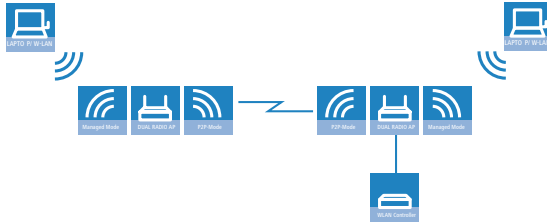

### 13.2.7 Wireless Distribution System (point-to-multipoint)

A special type of wireless link is the connection of several distributed Access Points to a central point – the point-to-multipoint wireless LAN (P2MP) is also referred to as a Wireless Distribution System (WDS). This mode of operation allows for example several buildings on a company's premises to be connected to the central administrative building. The central Access Point or Wireless Router is configured as "master" and the remote WDS stations as "slaves".

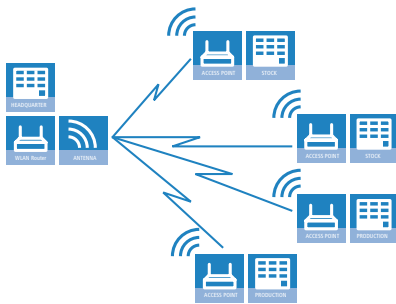

### 13.2.8 Client mode

In order for individual devices equipped with an Ethernet interface to be connected to a wireless LAN, LANCOM Access Points can be switched to client mode, in which they act as conventional wireless LAN adapters and not as access points (AP). Special client devices are offered alternatively, which can be operated in this mode only. The use of client mode therefore allows devices fitted with only an Ethernet interface, such as PCs and printers, to be integrated into a wireless LAN.

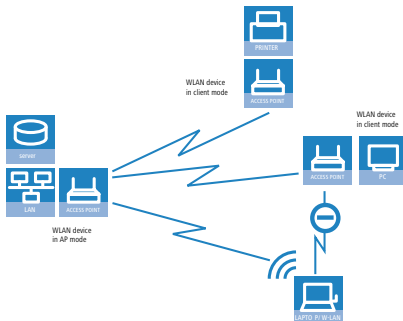



### 13.2.9 Client mode with mobile objects in industry

Completely new applications allow wireless LAN systems in industrial environments to transmit data to mobile objects. In logistics, for example, this means that fork-lift trucks can stay continuously connected to the company network via the wireless LAN. In combination with mobile barcode scanners, inventory movements within a warehouse can be monitored in real time and passed on to an ERP system, which then provides all employees with up-to-the-minute information on current inventories at all times.

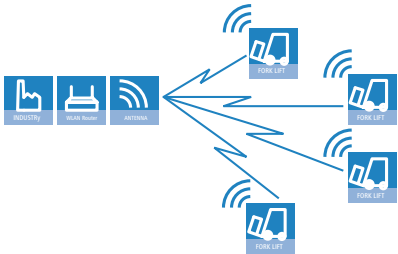

## 13.3 WLAN standards

LANCOM WLAN devices operate with the IEEE 802.11 standard. This is a collection of standards that build on the earlier IEEE standards for LANs. The best known of these is IEEE 802.3 for Ethernet. Among the various IEEE 802.11 standards, some specify wireless transmissions in various frequency bands and at different speeds. LANCOM Access Points and AirLancer client adapters are available which support a number of these standards:

- IEEE 802.11n with up to 300 Mbps data rate in the 5 GHz or 2.4 GHz frequency bands, featuring new mechanisms such as MIMO, 40-MHz channels, packet aggregation, and block acknowledgement.
- IEEE 802.11a with up to 54 Mbps data rate in the 5 GHz frequency band, up to 108 Mbps with Turbo Mode (extension to the standard).
- IEEE 802.11g with up to 54 Mbps data rate in the 2.4 GHz frequency band, up to 108 Mbps with Turbo Mode (extension to the standard).
- Even though modern WLAN adapters generally operate with 802.11a/g/n, LANCOM Access Points remain compatible to older WLAN adapters supporting 802.11b with up to 11 Mbps in the 2.4-GHz frequency band.

By observing these IEEE standards, LANCOM WLAN products operate with devices from other manufacturers reliably and without problems. Depending on the model, your LANCOM Access Point supports the standards IEEE 802.11g (backwardly compatible to IEEE 802.11b) and/or IEEE 802.11a and IEEE 802.11n draft 2.0.

The WLAN module in the Access Points only operates in one frequency band at a time, i.e. either at 2.4 GHz or 5 GHz. It is impossible to operate at different frequencies with a single WLAN module. However, Access Points with two WLAN modules (dual radio) can operate each module at a different frequency. As the standards in the 2.4 GHz band IEEE 802.11b/g/n are backwardly compatible, various standards can be operated simultaneously on a single WLAN module, although lower data rates are incurred

### 13.3.1 Data rates in compatibility mode

Please note that data rates available with IEEE 802.11b/g/n devices depend upon the 2.4-GHz mode being used. If slower units become active in a wireless network in compatibility mode, the overall data rate will drop

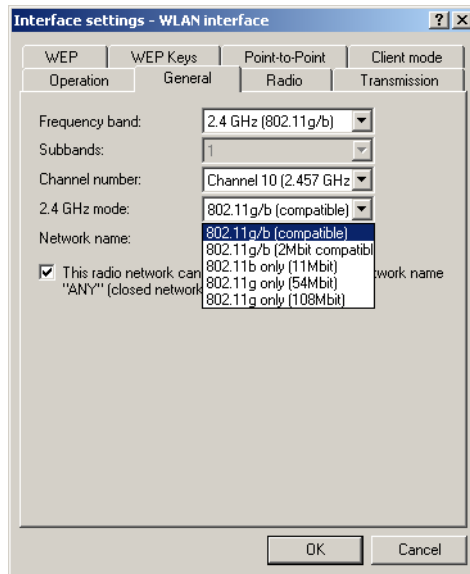

! Please note that not all of the available frequencies are approved for use in all countries! A table of frequencies and licensing regulations is to be found in the appendix of the manual for each device.

### 13.3.2 IEEE 802.11n

The new wireless LAN standard 802.11n features a number of technical developments that provide up to five-times the wireless-LAN performance in the 5 GHz or 2.4 GHz frequency bands. The changes have not yet been officially approved by the IEEE, but the foreseeable technological leap is so enticing that the industry is already bringing updated WLAN devices to market before the standards have been adopted. Current discussions are embodied by what is known as "draft 2.0", which is the basis for devices currently available on the market.

! Any reference to "802.11n" in this document always implies the current draft 2.0, which is not a standard adopted by the IEEE.

Some of the improvements refer to the physical layer (PHY), which describes the transmission of individual bits over the physical medium—in this case the air represents the physical medium. Other additions are concerned with the MAC (medium access control) that among other things governs access to the transmission medium. The two areas are treated separately below.

#### Advantages of 802.11n

The new technology includes the following advantages:

- Higher effective data throughput

802.11n draft 2.0 includes a number of new mechanisms to significantly increase available bandwidth. Current wireless LAN standards based on 802.11a/g enable physical data rates (gross data rates) of up to 54 Mbps, which turn out to be approx. 22 Mbps net. Networks based on 802.11n **currently** achieve a gross data throughput of up to 300 Mbps (in reality approx. 120 to 130 Mbps net) – theoretically the standard defines up to 600 Mbps with four data streams. For the first time, maximum speeds exceed the 100 Mbps of cable-based Fast Ethernet networks, which are currently standard in most workplaces.

- Improved and more reliable wireless coverage

The new 802.11n technologies do not just increase data throughput but bring about improvements in the range and reduce the wireless dead spots in existing a/b/g installations.

This results in better signal coverage and improved stability for significantly better utilization of wireless networks, in particular for users in professional environments.

- Greater range

Data throughput generally decreases when the distance between receiver and transmitter increases. The overall improved data throughput allows wireless LANs based on 802.11n to achieve greater ranges, as a significantly stronger wireless signal is received by the Access Point over a given distance than in 802.11a/b/g networks.

## Compatibility with other standards

The 802.11n standard is backwardly compatible to previous standards (IEEE 802.11a/b/g). However, some of the advantages of the new technology are only available when, in addition to the access points, the wireless LAN clients are also compatible with 802.11n.

In order to allow the co-existence of wireless LAN clients based on 802.11a/b/g (called "legacy clients") 802.11n access points offer special mechanisms for mixed operation, where performance increases over 802.11a/b/g are not as high. Only in all-802.11n environments is the "greenfield mode" used, which can exploit all the advantages of the new technology. In greenfield mode both access points and wireless LAN clients support the 802.11n Draft, and access points reject connections with legacy clients.

## The physical layer

The physical layers describes how data must be transformed in order for them to be transmitted as individual bits over the physical medium. In this process the following steps are performed in a wireless LAN device:

- Modulation of digital data into analog carrier signals
- Modulation of the carrier signal into a radio signal in the selected frequency band, which for a wireless LAN is either 2.4 or 5 GHz.

The second modulation step in IEEE 802.11n occurs in the same way as in conventional wireless LAN standards and is therefore not covered here. However, there are a number of changes in the way digital data are modulated into analog signals in 802.11n.

## Technical aspects of 802.11n

- Improved OFDM modulation (MIMO-OFDM)

Like 802.11a/g, 802.11n uses the OFDM scheme (Orthogonal Frequency Division Multiplex) as its method of modulation. This modulates the data signal not on just one carrier signal but in parallel over several. The data throughput that can be achieved with OFDM modulation depends on the following parameters, among other things:

- Number of carrier signals: Whereas 802.11a/g uses 48 carrier signals, 802.11n can use a maximum of 52.

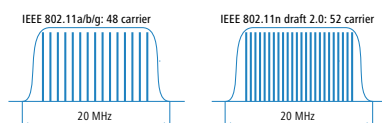

- Payload data rate: Airborne data transmission is fundamentally unreliable. Even small glitches in the WLAN system can result in errors in data transmission. Check sums are used to compensate for these errors, but these take up a part of the available bandwidth. The payload data rate indicates the ratio between theoretically available bandwidth and actual payload. 802.11a/g can operate at payload rates of 1/2 or 3/4 while 802.11n can use up to 5/6 of the theoretically available bandwidth for payload data.

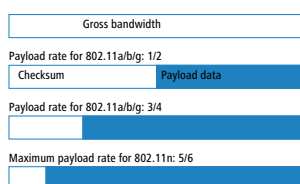

These two features increase the maximum useable bandwidth of 54 Mbps for 802.11a/g to 65 Mbps for 802.11n. This increase is not exactly spectacular, but it can be further improved by using the following features:

- MIMO technology

MIMO (multiple input multiple output) is the most important new technology contained in 802.11n. MIMO uses several transmitters and several receivers to transmit up to four parallel data streams on the same transmission channel (currently only two parallel data streams have been implemented). The result is an increase in data throughput and improved wireless coverage.

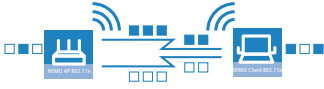

For example, the Access Point splits the data into two groups which are then sent simultaneously via separate antennas to the WLAN client. Data throughput can therefore be doubled using two transmitting and receiving antennas.

But how can several signals be transmitted on a single channel simultaneously? This was considered impossible with previous WLAN applications.

Let us consider how data is transmitted in "normal" wireless LAN networks: Depending on antenna type, an Access Point's antenna broadcasts data in several directions simultaneously. These electromagnetic waves are reflected by the surrounding surfaces causing a broadcast signal to reach the WLAN client's antenna over many different paths; this is also referred to as "multipath propagation". Each of these paths has a different length meaning that individual signals reach the client with a different time delay.

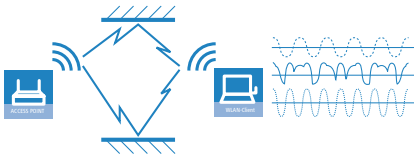

These time-delayed signals interfere with each other at the WLAN client and significantly weaken the original signal. For this reason, conventional WLAN networks should always have a direct line of sight (LOS) between transmitter and receiver in order to reduce the influence of reflections.

MIMO technology transforms this weakness in WLAN transmission into a strength that allows an enormous increase in data throughput. As mentioned above, it is virtually impossible to transmit different signals on the same channel simultaneously as the receiver cannot distinguish between them. MIMO uses the reflection of electromagnetic waves and the associated spatial aspect to obtain a third criterion for identifying the signals.

A signal sent by transmitter A and received by receiver 1 follows a different path than a signal from transmitter B to receiver 2. Due to the different reflections and changes in polarization that both signals experience along their paths, each of these paths takes on its own characteristics. When data transmission starts, a training phase records the characteristics of the path by transmitting standardized data. Subsequently, the data received here is used to calculate which data stream the signals belong to. The receiver decides for itself which of the incoming signals is to be processed, thus avoiding loss from interference.

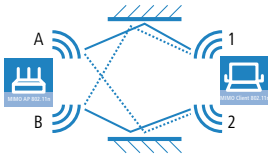

MIMO thus allows the simultaneous transmission of several signals over one shared medium, such as the air. Individual transmitters and receivers must be positioned a minimum distance apart from one another, although this is just a few centimeters. This separation results in differing reflections and signal paths that can be used to separate the signals.

Generally speaking, MIMO can provide up to four parallel data streams, which are also called "spatial streams". However, the current generation of chips can only implement two parallel data streams as the separation of data streams based on characteristic path information demands high levels of computing power, which consumes both time and electricity.

The latter tends to be undesirable particularly for WLAN systems, where attempts are often made to achieve independence from power sockets at the WLAN client or when using PoE as the electricity supply for the Access Point.

Even if the aim of four spatial streams has not yet been achieved, the use of two separate data connections results in a doubling of data throughput, which represents a true technological leap in the area of WLAN systems. Combined with the improvements in OFDM modulation, the data throughput that can be attained increases to 130 Mbps.

The short description "transmitter x receiver" expresses the actual number of transmitting and receiving antennas. 3x3 MIMO describes three transmitting and three receiving antennas. However, the number of antennas does not equate with the number of data streams: the antennas available only limit the maximum number of spatial streams. The reason for using more antennas than strictly necessary for data stream transmission relates to the method of allocating the signals according to their characteristic path: A third signal is used to transmit additional spatial information. If the data from the first two signals cannot be uniquely identified, their computation can still be performed with the aid of the third signal. The use of additional antennas does not contribute to an increase in data throughput, but it does result in a more even, stronger coverage for clients.

- MIMO in outdoor use

Outdoor 802.11n applications cannot use natural reflections since signal transmission usually takes place over the direct path between directional antennas. In order to transmit two data streams in parallel, special antennas are employed that use polarization channels turned through 90° to each other. These so-called "dual-slant" antennas are really two antennas in one housing. Since a third signal does not offer additional reliability, outdoor applications generally use as many antennas (or polarization channels) as there are data streams for transmission.



- 40 MHz channels

As the above explanation of OFDM modulation states, data throughput rises with an increasing number of carrier signals because this allows several signals to be transmitted simultaneously. If a channel with a bandwidth of 20 MHz supports no more than 48 (802.11a/g) or 52 (802.11n) carrier signals, the obvious choice would be to use a second channel with additional carrier signals.

This method was used in the past by a number of manufacturers (including LANCOM Systems) and was referred to as "turbo mode", allowing data rates of up to 108 Mbps. Turbo mode does not form part of the official IEEE standard but is frequently employed on point-to-point connections, for example, because compatibility to other manufacturers tends to play a secondary role.

However, the success of the underlying technology has led to its incorporation into 802.11n. IEEE 802.11n draft 2.0 uses the second transmission channel in a way that maintains compatibility to IEEE 802.11a/g devices. 802.11n transmits data over two contiguous channels. One of these assumes the task of a control channel that, among other things, handles the administration of data transmission. Concentrating these basic tasks into the control channel means that devices supporting a transmission at 20 MHz only can also be connected. The second channel is an extension that only comes into effect if the remote client also supports data transmission at 40 MHz. The use of the second channel remains optional throughout, with transmitter and receiver deciding dynamically whether one or two channels should be employed.

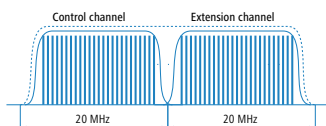

As the implementation of 40 MHz with separate control and extension channels is more efficient in the 802.11n draft than in the conventional turbo mode, more than double the amount of carrier signals can be obtained (108 in total). The maximum data throughput when using improved OFDM modulation and two parallel data streams thus rises to 270 Mbps.

- Short guard interval

The final improvement of the 802.11n draft is the improvement in the chronological sequence of data transmission. A signal that is to be transmitted in a WLAN system is not broadcast at a distinct point in time but is "held up" for a certain, constant transmission period. In order to prevent interference at the receiving end, a short break is made following the transmission period before the transmission of the next signal commences. The entire duration of transmission period and break are referred to in WLAN terminology as "symbol length" and the break itself is known as the "guard interval".

IEEE 802.11a/g uses a symbol length of 4  $\mu$ s: the information transmitted on the carrier signal changes following transmission of 3.2  $\mu$ s and a break of 0.8  $\mu$ s. 802.11n reduces the break between transmissions to the so-called "short guard interval" of only 0.4  $\mu$ s.

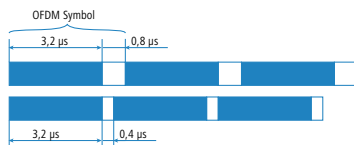

Transmitting data in shorter intervals thus increases the maximum data throughput when using improved OFDM modulation, two parallel data streams and transmission at 40 MHz to 300 Mbps.

### Optimizing net data throughput

The methods described so far are intended to improve the maximum physically possible data throughput. The methods described below are used in 802.11n networks to optimize net data throughput, i.e. the throughput of actual payload data.

- Frame aggregation

In addition to the actual payload data, each data packet includes management information, which is important for the smooth exchange of data. Frame aggregation is used to combine several data packets (frames) into one large packet. As a consequence, management information only needs to be specified once for the complete data packet, and the proportion of payload data to the total data volume increases.

- Block acknowledgement

Each data packet is acknowledged on receipt. In this way, the transmitter is informed that the packet was received correctly and does not need to be repeated. This principle also applies to aggregated frames in 802.11n.

However, some packets in an aggregated frame may be delivered successfully while others are not. In order to avoid having to retransmit an entire aggregated frame from which perhaps just one data packet was **not** delivered, a separate acknowledgement is generated for every single WLAN packet in the aggregated frame. These acknowledgements are again combined to form a block and relayed back to the sender as a group (block acknowledgement). The sender receives information about the receipt status of every single WLAN packet and can, if necessary, resend only those specific packets that were not successful.

### The MAC layer

- Frame aggregation

The improvements in the physical layer brought about by the new 802.11n initially describe only the theoretical data throughput of the physical medium. However, the share of this theoretical bandwidth that is actually available for payload data is limited by two factors:

- in addition to the actual payload data, each data packet in a wireless LAN system contains additional information such as a preamble and MAC address information.
- Time is lost to the management events that occur when the transmission medium is actually accessed. Thus the transmitter must negotiate access authorization with the other receivers before transmitting each data packet (frame); further delays are caused by data packet collisions and other events.

This loss, referred to as "overhead", can be reduced by combining several data packets together to form one large frame and transmitting them together. In this process, information such as the preamble are only transmitted once for all the combined data packets and delays due to negotiating access to the transmission medium only occur at longer intervals.

The use of this method, known as frame aggregation, is subject to certain restrictions:

- As information such as MAC address only needs to be transmitted once for the aggregated frame, only those data packets intended for the same address can be combined.
- All data packets that are to be combined into a single large frame must be available at the sender at the time of aggregation—as a consequence some data packets may have to wait until enough data packets for the same destination are available with which they can be combined. This aspect may represent a significant limitation for time-critical transmissions such as voice over IP.
- Block acknowledgement

Each data packet directed to a specific address (i.e. not broadcast or multicast packets) is acknowledged immediately after receipt. In this way, the transmitter is informed that the packet was received correctly and does not need to be repeated. This principle also applies to aggregated frames in 802.11n.

Two different methods are used for frame aggregation. These are not explained in detail here, but they differ in the way aggregated frames are acknowledged.

- Mac Service Data Units Aggregation (MSDUA) combines several Ethernet packets together to form one common wireless LAN packet. This packet is acknowledged only once and the acknowledgment is valid for all aggregated packets. If there is no acknowledgement the whole block is resent.
- Mac Protocol Data Units Aggregation (MPDUA) combines individual wireless LAN packets together to form one large common wireless LAN packet. In this case, each wireless LAN packet is acknowledged and the acknowledgements are combined and transmitted as a block. In contrast to MSDUA, the sender receives information about the receipt status of every single WLAN packet and can, if necessary, resend only those specific packets that were not successful.

## Resulting data throughput

The overall data throughput in a 802.11n network is determined by applying the methods described above. A specific combination of modulation method, payload data rate and number of spatial streams is referred to as modulation coding scheme (MCS). Data throughput also depends on whether the short guard interval and channel bundling to 40 MHz are used.

802.11n uses the term "data throughput" instead of the term "data rate" used in older WLAN standards, because data rate is no longer an adequate description. The following table shows the maximum data throughput when using the short guard interval with 40 MHz channels.

The net data throughput, i.e. the actual number of IP packets transferred, can be up to 90 Mbps for one 802.11n data stream and, accordingly, for two spatial streams up to 180 Mbps. The net data throughput currently (early 2008) observed in practice is usually between 80 and 130 Mbps, depending on how mature the hardware and software are and also on how well the different manufacturers' chip sets work together.

Data streams	Modulation	Payload data rate	Data throughput (GI=0.4 $\mu$ s, 40 MHz)
1	BPSK	1/2	15
1	QPSK	1/2	30
1	QPSK	3/4	45
1	16QAM	1/2	60
1	16QAM	3/4	90
1	64QAM	1/2	120
1	64QAM	3/4	135
1	64QAM	5/6	150
2	BPSK	1/2	30
2	QPSK	1/2	60
2	QPSK	3/4	90
2	16QAM	1/2	120

Data streams	Modulation	Payload data rate	Data throughput (GI=0.4 $\mu$ s, 40 MHz)
2	16QAM	3/4	180
2	64QAM	1/2	240
2	64QAM	3/4	270
2	64QAM	5/6	300

### Addition(s) to LCOS 8.60

#### How the 40-MHz mode works

#### Additions to the menu system

#### Allow 40MHz

The default setting automatically optimizes the value for bandwidth. If the momentary operating conditions allow, a bandwidth of 40MHz will be enabled, which is otherwise limited to 20MHz.

You also have the option of switching this mechanism off, so limiting the bandwidth to the narrower 20MHz.

The 802.11n standard specifies a channel bonding from 20MHz to 40MHz.

**Telnet path:**/Setup/Interfaces/WLAN/Radio-Settings/Allow-40MHz

### 13.3.3 IEEE 802.11a: 54 Mbps

IEEE 802.11a specifies the operation of wireless LANs in the 5-GHz frequency band (5.15 GHz to 5.75 GHz) with data rates of up to 54 Mbps. Actual throughput depends on the distance and the quality of the connection. With longer distances and lower connection quality data rates sink to 48 Mbps, thereafter to 36 Mbps and so on until a minimum of 6 Mbps is reached. The range of transmission in the open can reach up to 125m. Inside of buildings this would typically be 25m. The IEEE 802.11a standard operates with OFDM (**O**rtogonal **F**requency **D**ivision **M**ultiplexing).

OFDM is a modulation technique that uses multiple carrier frequencies to form the data signal. The technique modulates these carrier frequencies with a reduced data rate. OFDM is highly resistant to the effects of echoes and other impairments, and it enables higher data rates.

In 'Turbo Mode' LANCOM Router base stations can use two radio channels simultaneously to increase data rates to a maximum of 108 Mbps. Turbo mode works with the IEEE 802.11a standard between LANCOM base stations and AirLancer wireless network cards. This increase in data rate must be activated in the base station. This can cause a reduction in transmitting power and range.

### 13.3.4 IEEE 802.11h – ETSI 301 893

In November 2002, the 5 GHz band was released for private use in Germany, and opened up the path for significantly faster WLAN connections according to the IEEE 802.11a standard, which had already been available for a while. The wider use of 5 GHz WLANs was, however, restricted by its exclusive use in closed spaces and the relatively low transmission power.

With the 802.11h enhancement of September 2003, the private use of the 5 GHz band was finally possible even outside closed spaces. To protect military applications in the 5 GHz band, the DFS (Dynamic Frequency Selection) and TPC (Transmission Power Control) procedures were prescribed. However, when using DFS and TPC with a maximum of 1000 mW (or 4000 mW for commercial network operators in compliance with "Broadband Fixed Wireless Access" regulations), much higher transmission powers can be operated than allowed by previous standards.

#### ETSI standards

ETSI adopted the first standard for controlling remote data transfers as early as 1996 under the name of Hiperlan (High Performance Radio Local Area Networks). The first version (Hiperlan Type 1) was intended for use in the frequency range



of 5.15 to 5.30 GHz with a transmission rate of 20 Mbps. As no manufacturers took up this standard, Hiperlan initially had no practical significance.

With the new version in 2000, Hiperlan Type 2, ETSI introduced a WLAN solution that operates in the 5 GHz band similar to IEEE 802.11a, and also provides a gross data rate of 54 Mbps. However, as the frequencies and the OFDM modulation method that was also used for 802.11a overlapped, it was necessary to adapt the standards between IEEE and ETSI to avoid disruptions to the systems.

## European harmonization

To standardize the use of the 5 GHz band in Europe, the European Commission issued the ETSI 301 893 standard on July 11, 2005. The member states of the EU were obliged to implement this by October 31, 2005.

Instead of the three sub-bands described in the 802.11a/h standards (5150 - 5350 MHz, 5470 - 5725 MHz and 5725 - 5875 MHz for the UK), the ETSI 301 893 standard regulates the three following areas with different specifications:

- 5150 - 5250 MHz
- 5250 - 5350 MHz
- 5470 - 5725 MHz

The guidelines focus on preventive measures for avoiding disruptions to other systems that use the same frequency band. This includes radar equipment that counts as "primary applications". The "secondary applications" such as WLAN have to change the frequency as soon as a conflict is detected.

## Special regulations for the 5 GHz band

- Dynamic Frequency Selection – DFS

Certain requirements must be observed for the outdoor operation of 5-GHz WLANs if you wish to utilize the maximum permitted performance of 1 or 4 watts. It is vital to avoid interference with radar systems that are active in this spectrum (e.g. meteorological, military). For this reason the European regulatory authority ETSI requires WLAN devices operating at 5 GHz to employ the dynamic frequency selection (DFS) mechanism.

This ensures that radar and WLAN systems can co-exist without interfering with one another and that capacity utilization is spread evenly across available frequencies. When starting a WLAN wireless cell, the access point must check all channels for the presence of radar systems. The check requires an inactive period of one minute, during which the wireless cell cannot be used. As a result, the access point generates a list of radar-free channels which is valid for 24 hours. The best possible channel for operation is selected from this list. During operation, the current channel is continuously checked for radar activity.

If a radar system subsequently starts operation, the channel must be released immediately. In this case, the access point selects the next best available channel, informs the participants in the wireless cell of the impending change, and switches the channel.

---

 The currently selected channel can be used for any length of time, unless radar signals are detected or if the radio cell is restarted (e.g. due to device reconfiguration, firmware upload or reboot).

---

 If the system is able to respond to a channel switch instantaneously, the check must be repeated within 24 hours following a one-minute period of inactivity. The parameter "DFS Rescan Hours" (LCOS menu tree under "Setup/Interfaces/WLAN/Radio settings") allows a time to be set for conducting the channel check (assuming that the time is available, for example via NTP).

- DFS is stipulated for the frequency ranges from 5250 - 5350 MHz, 5470 - 5725 MHz and from 5775 – 5875 (BFWA). It is optional for the frequency range of 5150 - 5250 MHz.
- Transmission Power Control – TPC

Automatic adjustment of the transmission power reduces radio interference.

Without DFS and TPC, a maximum of only 200 mW EIRP is permitted. When operating DFS and TPC, a maximum of 200 mW (5150 to 5350 MHz) and 1000 mW EIRP (5470 to 5725 MHz) is permitted as transmitting power (compare 100 mW for 802.11b/g, 2.4 GHz, where DFS and TPC are unnecessary). The higher maximum transmission power

not only compensates for the higher attenuation of 5 GHz radio waves in air, it also makes significantly longer ranges possible than in the 2.4 GHz range.

- BFWA (broadband fixed wireless access)

In Germany in July, 2007, the Federal Network Agency released additional frequencies for broadband fixed wireless bridges in the 5 GHz band. These additional frequencies located in the range between 5755 MHz - 5875 MHz are also referred to as BFWA (Broadband Fixed Wireless Access). The additional frequencies are intended for long-distance point-to-point (P2P) or point-to-multipoint (P2M) links used for providing high-speed Internet access to other users from a central node. This method is intended to provide rural areas with high-speed Internet access.

The operation of BFWA is restricted to commercial providers only. There are no charges for using these frequencies, but registration is required by the Federal Network Agency. This band covers 120 MHz and offers 6 channels with a bandwidth of 20 MHz each. Maximum transmission power is 36 dBm or 4000 mW. TPC and DFS have to be used when operating BFWA links.

### Differences from USA and Asia

The USA and Asia use different frequency bands and maximum signal strengths that are different than the European standard.

In the USA, three subbands, each 100 MHz wide, are used for wireless networks in the 5 GHz band. The "lower band" ranges from 5150 - 5250 MHz, the "middle band" ranges from 5250 - 5350 MHz and the "upper band" ranges from 5725 - 5825 MHz. In the lower band, a maximum average EIRP of 50 mW is permitted; in the middle band this is 250 mW and 1 W in the upper band.

In Japan, the use of the 5 GHz band is possible to a limited extent: only the lower band of 5150 - 5250 MHz is approved for private use.

### Available channels in the 5 GHz band

In the available frequency range of 5.13 to 5.875 GHz, the following channels are available in Europe, divided into frequency ranges to which different conditions of use can apply:

- 5150 -5350 MHz (channels 36, 40, 44 and 48)
- 5250 -5350 MHz (channels 52, 56, 60 and 64)
- 5470 - 5725 MHz (channels 100, 104, 108, 112, 116, 132, 136 and 140)
- 5755 - 5875 MHz
  - Channels 151, 155, 159, 163, 167: In Germany is for commercial use only and only in combination with DFS (BFWA).
  - Channels 149, 153, 157, 161, 165: For FCC use in the USA, without DFS.

---

 Channels 120, 124 and 128 have been available in the past and are now blocked.

The following overview shows which channels may be used in the different regions:

---

 \* Note: Please note that the frequency ranges and radio channels in band 3 are subject to certain restrictions depending on country (e.g. in Germany only permitted for public "Broadband Fixed Wireless Access" communications providers).

### Frequency ranges for indoor/outdoor use in the 5 GHz band

The use of the methods described in ETSI 301 893 for reducing mutual interference in the 5 GHz band (TPC and DFS) is not stipulated for all fields of application. The following table provides information about the permitted use and corresponding transmission powers within the EU:

Frequency (GHz)	Transmissionpower (mW/dBm)	Use	DFS	TPC
5,15-5,25	200/23	Indoor		
5,25-5,35	200/23	Indoor	4	4
5,470-5,725	1000/30	Indoor/Outdoor	4	4
5,755-5,875	4000/36	Outdoor (BFWA)	4	4

 Other regulations may apply for use in other countries. Please refer to the current wireless network regulations for the country in which you wish to operate a wireless LAN device, and ensure that you set the country of operation in the wireless LAN settings.

### 13.3.5 IEEE 802.11g: 54 Mbps

The IEEE 802.11g standard also works with data rates of up to 54 Mbps in the 2.4 GHz ISM frequency band. Unlike IEEE 802.11b, the IEEE 802.11g standard works with OFDM modulation, as used by the earlier standard IEEE 802.11a. IEEE 802.11g features a specialized compatibility mode for backwards compatibility with the widely available IEEE 802.11b standard. However, operating this compatibility mode incurs performance losses. IEEE 802.11g is not compatible to IEEE 802.11a as they operate at different frequencies. IEEE 802.11g products offer similar ranges to IEEE 802.11b products.

The 802.11g standard can also be operated with Turbo Mode, which uses two radio channels in parallel to increase data rates to a maximum of 108 Mbps. Because the 2.4-GHz band has fewer channels to offer than the 5-GHz band, operating Turbo Mode places clear limits on the choice of available channels.

### 13.3.6 IEEE 802.11b: 11 Mbps

IEEE 802.11b specifies the operation of local wireless networks in the ISM frequency band (**I**ndustrial, **S**cientific, **M**edical: 2.4 to 2.483 GHz). Maximum data rates are up to 11 Mbps. Actual throughput depends on the distance and the quality of the connection. With longer distances and lower connection quality data rates sink to 5.5 Mbps, thereafter to 2 Mbps and then to 1 Mbps. The range of transmission in the open can reach up to 150 m. Inside of buildings this would typically be 30 m. IEEE 802.11b is not compatible to IEEE 802.11a as they operate at different frequencies.

To protect against interference from other transmitters operating on the same frequency, the 2.4-GHz frequency band for IEEE 802.11b offers the DSSS procedure (**D**irect **S**equen**S** **S**pread **S**pectrum). Generally, a transmitter occupies only a very narrow band of the available frequencies. If this band is also being used by another transmitter, interference may occur. The DSSS method uses a broader band of the available frequency range, making it less sensitive to narrow-band interference.

## 13.4 WLAN security

### 13.4.1 Basics

Even though one constantly hears the blanket term 'Security' when talking about computer networks, it is still important for the coming exposition to differentiate a little more closely between the requirements it actually entails.

#### Authentication

The first point in security is access security:

- Here, a protective mechanism is involved which allows access to the network only to authorized users.
- On the other hand, however, it must also be ensured that the client is connected to the precise desired access point, and not with some other access point with the same name which has been smuggled in by some nefarious third party. Such an authentication can be provided, for example, using certificates or passwords.

## Authenticity

Authenticity: Proof of the authorship of the data and the originality of the data content; the process of establishing this proof is known as authentication.

## Integrity

Once access is provided, one would like to ensure that data packets reach the receiver without any falsification, that is, that no-one can change the packets or insert other data into the communication path. The manipulation of data packets themselves cannot be prevented, but changed packets can indeed be identified using suitable checksum processes, and then dropped.

## Confidentiality

Quite separate from access security is confidentiality, that is, unauthorized third parties must not be able to read the data traffic. To this end, the data are encrypted. This sort of encryption process is exemplified by DES, AES, RC4, or Blowfish. Along with encryption, of course, there must also be a corresponding decryption on the receiving end, generally with the same key (a so-called symmetric encryption process). The problem naturally then arises, how the sender can give the key to the receiver for the first time—a simple transmission could very easily be read by a third party, who could then easily decrypt the data traffic.

In the simplest case, this problem is left to the user, that is, one simply assumes that the user can make the key known at both ends of the connection. In this case, one speaks of pre-shared keys, or 'PSK'.

More sophisticated processes come into play when the use of pre-shared keys is impractical, for instance in an HTTP connection built over SSL—in this case, the user can't retrieve a key from a remote web server quite so easily. In this case, so-called asymmetric encryption methods such as RSA can be used, that is, to **decrypt** the data, a different key is used than the one used to **encrypt** it, meaning that key pairs are used. Such methods are, however, much slower than symmetric encryption methods, which leads to a two-phase solution:

- The sender possesses an asymmetric key pair. It transmits the public part of the key pair, i.e. the key for **encryption**, to the receiver as a certificate, for example. Since this part of the key pair cannot be used for **decryption**, there are no misgivings with regard to security.
- The receiver selects any symmetrical key. This symmetrical key that is used both for **encryption** and for **decryption**, must now be securely transmitted to the sender. It is encrypted with the sender's public key and returned to the sender. The only way that the symmetrical key can be decrypted again is with the sender's private key. Potential eavesdroppers observing the key exchange cannot decrypt this information, and consequently the transmission of the symmetrical key is secure.

### 13.4.2 IEEE 802.11i /WPA2

In mid-2004 the IEEE adopted the standard 802.11i, also known as WiFi Protected Access 2 (WPA2). WPA2 is currently the highest standard of security available for WLANs. It enables the authentication and authorization of users by IEEE 802.1X. It also supports AES encryption, which is a far more secure technique than WEP or WPA. The following sections outline some relevant technical aspects.

#### EAP and IEEE 802.1x

A clear increase in WLAN security can be achieved by using keys that are dynamically negotiated instead of keys with fixed values. As the process to be used for this purpose, the Extensible Authentication Protocol has emerged. As the name suggests, the original purpose of EAP is authentication, that is, the regulated access to a WLAN—the possibility of installing a valid key for the next session is more or less a byproduct. Figure 2 shows the basic process of a session secured by EAP.

! In principle, EAP / 802.1X can be used in combination with WEP. However, this method is generally employed with WLANs using WPA2.

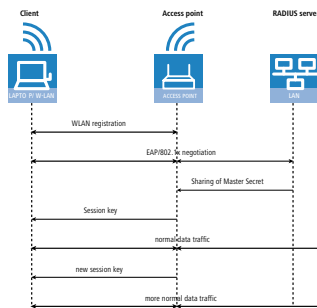

Figure 2: Schematic process of a WLAN session with EAP/802.1x

In the first phase, the client registers with the access point as usual, and enters the state in which it can now send and receive over the access point in the formerly used WEP—but not with EAP, because in this state the client still doesn't have a key to secure its data traffic from eavesdropping. Instead, the client is in an 'intermediate state' from the point of view of the access point, in which only particular packets from the client are forwarded, and these are only directed to an authentication server. These packets are the EAP/802.1x mentioned previously. The access point packs these packets in RADIUS queries and sends them on to the authentication server. The access point converts the replies coming from the RADIUS server back into EAP packets, and sends them back to the client.

The access point is thus a sort of middle man between client and server. it doesn't have to check the contents of these packets, it just has to check that no other data traffic to or from the client can occur. Over this "tunnel" through the access point, the client and server authenticate one another, that is, the server checks the client's access privilege to the network, and the client checks that it is talking to the right network. "Wild" access points set up by hackers can be recognized in this way.

A whole series of authentication processes exist which can be used in this tunnel. A current process (and one supported by Windows XP) is for instance TLS, in which server and client exchange certificates; another is TTLS, in which only the server supplies a certificate—the client is authenticated using only a username and password.

After the authentication phase, a secure tunnel even without encryption has been set up, in which the access point is connected in the next step. For this, the RADIUS server sends the so-called 'Master Secret', a session key calculated during the negotiation, to the access point. The LAN behind the access point is considered secure in this scenario, so that this transmission can be performed in clear text.

With this session key, the access point now takes over the tunnel and can use it to provide the actual key to the client. Depending on the capabilities of the access point hardware, this can be a true session key, i.e. a key which will only be used for data packets between the access point and precisely this client. Older WEP uses a hardware group key, which the access point will use for communication with multiple clients.

The particular advantage of this procedure is that the access point can regularly change the key over the EAP tunnel, that is, it can perform a so-called rekeying. In this way, keys can be replaced by new ones long before they run the risk of being cracked due to IV collisions. A common 'use time' for such keys might be 5 minutes.

## WPA with passphrase

The handshake described in the EAP/802.1X section runs strictly under WPA, i.e. the user will never have to define any keys. In environments in which no RADIUS server is available to provide master secrets (for instance in smaller companies), WPA therefore provides the PSK method besides authentication using a RADIUS server; here, the user must enter a passphrase of 8 to 63 characters on the access point and on all stations, from which the master secret is calculated along with the SSID used using a hash procedure. The master secret is therefore constant in such a PSK network, although different session keys still result.

In a PSK network both access security and confidentiality depend on the passphrase not being divulged to unauthorized people. As long as this is the case, WPA-PSK provides significantly improved security against break-ins and eavesdropping over any WEP variant. For larger installations in which such a passphrase would have to be made known to too large a user community for it to be kept secret, EAP/802.11i is used in combination with the key handshake described here.

## TKIP

TKIP stands for **T**emporal **K**ey **I**ntegrity **P**rotocol. As the name suggests, it involves an intermediate solution for temporary use until a truly strong encryption procedure is introduced, but which dealt with the problems of the then popular WEP, never the less. Employing TKIP is only recommended for operating older WLAN clients which do not support AES.

## AES

The most obvious extension is the introduction of a new encryption process, namely AES-CCM. As the name already hints, this encryption scheme is based on DES's successor AES, in contrast to WEP and TKIP, which are both based on RC4. Not all older WLAN chips support TKIP, so 802.11i continues to define TKIP, but with the opposite prerequisites: Any 802.11i-compliant hardware must support AES, while TKIP is optional. In WPA that was exactly the other way around. Using AES is optional.

The suffix CCM denotes the way in which AES is used in WLAN packets. The process is actually quite complicated, for which reason CCM is only sensibly implemented in hardware—software-based implementations are possible, but would result in significant speed penalties due to the processors commonly used in access points.

In contrast to TKIP, AES only requires a 128-bit key, with which both the encryption and protection against undetected changes to packets is achieved. Furthermore, CCM is fully symmetric, i.e. the same key is used in both communications directions—a standards compliant TKIP implementation, on the other hand, requires the use of different Michael keys in the send and receive directions, so that CCM is significantly simpler in use than TKIP.

Similar to TKIP, CCM uses a 48-bit Initial Vector in each packet—an IV repetition is impossible in practice. As in TKIP, the receiver notes the last IV used and drops packets with an IV which is equal to or less than the comparison value.

## Pre-authentication and PMK caching

802.11i is intended to help with the use of WLAN for speech connections (VoIP) in enterprise networks. Especially in connection with WLAN-based wireless telephony, quick roaming (switching from one access point to another without lengthy interruptions) is of special significance. In telephone conversations, interruptions of 100 milliseconds are irritating, but the full authentication process over 802.1x, including the subsequent key negotiation with the access point, can take significantly longer.

For this reason, the so-called PMK caching was introduced as a first measure. The PMK serves as the basis for key negotiation in an 802.1x authentication between client and access point. In VoIP environments it is possible that a user moves back and forth among a relatively small number of access points. Thus it may happen that a client switches back to an access point in which it was already registered earlier. In this case it wouldn't be sensible to repeat the entire 802.1x authentication again. For this reason, the access point can provide the PMK with a code, the so-called PMKID, which it transmits to the client. Upon a new registration, the client uses the PMKID to ask whether this PMK is still stored. If yes, the 802.1x phase can be skipped and the connection is quickly restored. This optimization is unnecessary if the PMK in a WLAN is calculated from a passphrase as this applies everywhere and is known.

A second measure allows for some acceleration even in the case of first-time registration, but it requires a little care on the part of the client. The client must already detect a degrading connection to the access point during operation and select a new access point while it is still in communication with the old access point. In this case it has the opportunity to perform the 802.1x negotiation with the new access point over the old one, which again reduces the "dead time" by the time required for the 802.1x negotiation.

### 13.4.3 TKIP and WPA

As clarified in the last section, the WEP algorithm is flawed and insecure in principle; the measures taken so far were largely either 'quick fixes' with limited improvement, or so complicated that they were basically impractical for home use or smaller installations.

After the problems with WEP became public knowledge, the IEEE began with the development of the standard IEEE 802.11i. As an interim solution, the WiFi Alliance defined the Wifi Protected Access (WPA) 'standard'. WPA uses the following changes:

- TKIP and Michael as replacement for WEP

- A standardized handshake procedure between client and access point for determination/transmission of the session key.
- A simplified procedure for deriving the Master Secret mentioned in the last section, which can be performed without a RADIUS server.
- Negotiation of encryption procedure between access point and client.

Encryption makes use of components familiar from WEP but benefits from decisive improvements with the "Michael hash" from improved encryption and the TKIP method for calculation of the RC4 key. Furthermore, the internally incremented IV transmitted in clear text in the packet is 48 bits long instead of 24--thus the problem with the repeating IV value is practically excluded.

As a further detail, TKIP also mixes the MAC address of the sender into the calculation of the key. This ensures that the use of identical IVs by different senders cannot lead to identical RC4 keys and thus again to attack possibilities.

The Michael hash does not, however, represent a particularly tough cryptographic hurdle: if the attacker can break the TKIP key or get encrypted packets past the CRC check via modifications similar to those for WEP, then not many barriers remain. For this reason, WPA defines countermeasures if a WLAN module detects more than two Michael errors per minute: both the client and the access point break data transfer off for one minute, afterwards renegotiating TKIP and Michael keys.

### Negotiating the encryption-method

Since the original WEP definition specified a fixed key length of 40 bits, the registration of a client at an access point only had to communicate whether encryption should be used or not. Key lengths exceeding 40 bits require that the key length is announced. WPA provides a mechanism with which client and access point can agree on the encryption and authentication procedures to be used. The following information is made available:

- A list of encryption methods which the access point provides for the pairwise key—here, WEP is explicitly disallowed.
- A list of authentication methods a client may use to show itself to the WLAN as authorized for access—possible methods are currently EAP/802.1x or PSK.

As mentioned, the original WPA standard specifies only TKIP/Michael as an improved encryption method. With the further development of the 802.11i standard, the AES/CCM method described below was added. In a WPA network it is now possible for some clients to communicate with the access point using TKIP, while other clients use AES.

## 13.4.4 WEP

WEP is an abbreviation for **Wired Equivalent Privacy**. The primary goal of WEP is the confidentiality of data. In contrast to signals which are transmitted over cables, radio waves spread out in all directions—even into the street in front of the house and other places where they really aren't desired. The problem of undesired interception is particularly obvious in wireless data transmission, even though it can also arise in larger installations with wired networks—however, access to cables is far more easily restricted than is the case with radio waves.

 WEP offers far lower security than IEEE 802.11i/WPA2. For reasons of compatibility to older WLAN clients, LANCOM Access Points continue to support this method of encryption. However, LANCOM Systems expressly recommends the use of a better form of WLAN security (e. g. IEEE 802.11i/WPA2).

## 13.4.5 LEPS – LANCOM Enhanced Passphrase Security

### LEPS remedies the security issues presented by global passphrases.

The modern encryption methods WPA and IEEE 802.11i provide data traffic in the WLAN with far improved security from eavesdroppers than the older WEP can. It is very easy to handle a passphrase as a central key; a RADIUS server such as that for 802.1x installations is not required.

However, the use of WPA and IEEE 802.11i still has some weak spots:

- A passphrase applies **globally** for **all** WLAN clients
- The passphrase may fall into unauthorized hands if treated carelessly

- The "leaked" passphrase then offers any attacker free access to the wireless network

This means in practice that: Should the passphrase "go missing" or an employee with knowledge of the passphrase leaves the company, then the passphrase in the access point needs to be changed in the interests of security—in every WLAN client, too. As this is not always possible, an improvement would be to have an individual passphrase for each user in the WLAN instead of a global passphrase for all WLAN clients. In the case mentioned above, the situation of an employee leaving the company requires merely his "personal" passphrase to be deleted; all others remain valid and confidential.

With LEPS (**L**ANCOM **E**nhanced **P**assphrase **S**ecurity), LANCOM Systems has developed an efficient method that makes use of the simple configuration of IEEE 802.11i with passphrase, but that avoids the potential security loopholes that come with global passphrases.

LEPS uses an additional column in the ACL (access-control list) to assign an **individual** passphrase consisting of any 8 to 63 ASCII characters to each MAC address. The connection to the access point and the subsequent encryption with IEEE 802.11i or WPA is only possible with the right combination of passphrase and MAC address.

This combination makes the spoofing of the MAC addresses futile—and LEPS thus shuts out a potential attack on the ACL. If WPA or IEEE 802.11i is used for encryption, the MAC address can indeed be intercepted—but this method never transmits the passphrase over wireless. This greatly increases the difficulty of attacking the WLAN as the combination of MAC address and passphrase requires both to be known before an encryption can be negotiated.

LEPS can be used both locally in the device and centrally managed with a RADIUS server. LEPS works with all WLAN client adapters available on the market without any modification. Full compatibility to third-party products is assured as LEPS only involves configuration in the access point.

- 
- ⓘ An additional security aspect: LEPS can also be used to secure single point-to-point (P2P) connections with an individual passphrase. Even if an access point in a P2P installation is stolen and the passphrase and MAC address become known, all other WLAN connections secured by LEPS remain secure, particularly when the ACL is stored on a RADIUS server.

### Configuration

The configuration of LEPS merely involves the assignment of an individual passphrase to the MAC address of each client that is approved for the WLAN. To this end, the MAC filter is set to positive, i.e. the data from clients entered here will be transmitted.

- 
- ⓘ The passphrases should consist of a random string at least 32 characters long.

### 13.4.6 Standard WEP encryption

Ex-factory, WEP128 encryption is activated for every unconfigured LANCOM Wireless Router as standard. This encryption is only to be used until the WLAN is configured for the first time.

Ex-factory, LANCOM Access Points are set to "managed mode" as standard, and the WLAN modules are switched off. For this reason the first-time configuration of LANCOM Access Points via WLAN is not possible. This WEP encryption in WLAN devices being managed by a LANCOM WLAN Controller is overwritten by the central encryption settings in the profiles of the WLAN Controller.

The key for the standard WEP encryption consists of the first letter "L" followed by the LAN MAC address of the access point in ASCII characters. The LAN MAC addresses of the LANCOM devices always begin with the character string



"00A057". You will find the LAN MAC address on a sticker on the base of the device. **Only** use the number labeled as "MAC address" that starts with "00A057". The other numbers that may be found are **not** the LAN MAC address.



A device with the LAN MAC address "00A0570FB9BF" thus has a standard WEP key of "L00A0570FB9BF". This key is entered into the 'Private WEP settings' of the device for each logical WLAN network as 'Key 1'.

To use a WLAN adapter to establish a connection to a new LANCOM access point, the WEP128 encryption must be activated for the WLAN adapter and the standard 13-character WEP key entered.

- 
- ⓘ After registering for the first time, switch the WLAN encryption to WPA2/802.11i to ensure that you have a secure connection.
  - ⓘ Note that a reset causes the WLAN key settings to be lost from the device and the standard WEP key comes into effect again. WLAN access can only work after a reset if the standard WEP key is programmed into the WLAN client as well.

## Addition(s) to LCOS 7.70

### Standard encryption with WPA2

The factory settings (or those after resetting the device) are different in LANCOM access points than in LANCOM wireless routers.

- Unconfigured access points with standard factory settings cannot be commissioned by means of the WLAN interface. The WLAN modules are switched off and the devices search the LAN for a LANCOM WLAN controller which will supply a configuration profile.
- Unconfigured wireless routers with standard factory settings cannot be commissioned by means of the WLAN interface. Furthermore, encryption with WPA-PSK as described here is used as standard.

The preshared key (PSK) for the standard WPA encryption consists of the first letter "L" followed by the LAN MAC address of the access point in ASCII characters. The LAN MAC addresses of the LANCOM devices always begin with the character

### 13 Wireless LAN (WLAN)

string "00A057". You will find the LAN MAC address on a sticker on the base of the device. **Only** use the number labeled as "LAN MAC address" that starts with "00A057". The other numbers that may be found are **not** the LAN MAC address.

A device with the LAN MAC address "00A05713B178" thus has a preshared key of "L00A05713B178". This key is entered into the 'WPA or private WEP settings' of the device for each logical WLAN network as 'Key 1/Passphrase'.

To use a WLAN adapter to establish a connection to a LANCOM wireless router that has factory settings, the WPA encryption must be activated for the WLAN adapter and the standard 13-character preshared key.

---

 After registering for the first time, change the WPA preshared key to ensure that you have a secure connection.

### 13.4.7 Background WLAN scanning

To detect other access points within range, LANCOM Wireless Routers actively scan all of the available channels (just as a WLAN client would do to find an available access point). If another access point is active, the relevant information is stored to the scan table. Since this recording occurs in the background in addition to the access points' "normal" radio activity, it is called a "background scan".

Background scanning is mainly used for the following tasks:

- Rogue AP detection
- Fast roaming for WLAN clients

#### Rogue AP detection

WLAN devices that make unauthorized attempts at accessing a WLAN by posing as an access point or client are called rogues. An example of rogue APs are access points that a company's employees connect to the network without the knowledge or permission of the system administrators, thereby consciously or unconsciously making the network vulnerable to potential attackers via unsecured WLAN access. Not quite as dangerous, but disruptive all the same are access points that belong to third-party networks yet are within the range of the local WLAN. If such devices also use the same SSID and channel as the local AP (default settings), then local clients could attempt to log on to external networks.

Unidentified access points within the range of the local network frequently pose a possible threat and security gap. At the very least, they are a disturbance. Therefore, background scanning identifies rogue APs and helps to decide whether further measures in securing the local network need to be introduced.

#### Fast roaming in client mode

However, the background scanning method can be used for objectives other than rogue AP detection. A LANCOM Access Point in client mode that logs itself on to another access point can also use the roaming procedure in a mobile installation. This is the case, for example, when a LANCOM Access Point used in an industrial application scenario is mounted to a forklift that navigates its way through multiple warehouses with separate access points. Under normal circumstances, the WLAN client would only log on to another access point when the connection to the access point it had been using until that moment was lost. With the background scanning function, the LANCOM Access Point using the client mode can collect information about other available access points in advance. In this case the client is not switched to another access point once the existing connection has been lost completely, but rather when another access point within its range has a stronger signal.

#### Evaluating the background scan

The information on the access points found can be viewed in the LANCOM Access Point statistics. The WLANmonitor presents the scan results quite conveniently and also offers additional functions such as access point grouping or automatic notification via e-mail whenever a new WLAN device appears.

---

 Please refer to for further information.

## 13.5 Configuration of WLAN parameters

Changes to the wireless network settings can be made at various points in the configuration:

- Some parameters concern the physical WLAN interfaces. Some LANCOM models have just one WLAN interface (single radio access point), and others have a second WLAN module integrated (dual radio access point). The settings for the physical WLAN interface apply to all of the logical wireless networks supported by this module. These parameters include, for example, the transmitting power of the antenna and the operating mode of the WLAN module (access point or client).
- Other parameters are related solely to the logical wireless network that is supported by a physical interface. These include, among others, the SSID or activation of the encryption, such as 802.11i with AES.
- A third group of parameters affect the wireless network operation, but are not significant **only** to WLANs. These include, for example, the protocol filter in the LAN bridge.

### 13.5.1 General WLAN settings

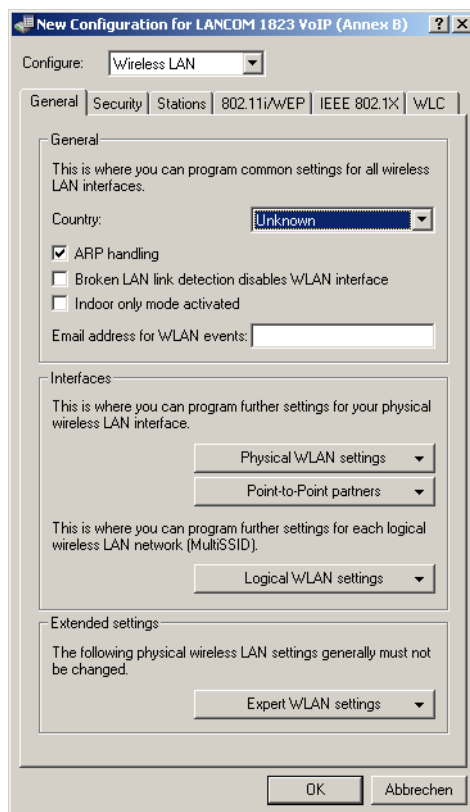

LANconfig: Wireless LAN / General

WEBconfig: LCOS menu tree / Setup / WLAN

- Country setting

Regulations for the operation of WLAN modules differ from country to country. The use of some radio channels is prohibited in certain countries. To operate the LANCOM access points while observing the regulations in various countries, all physical WLAN interfaces can be set up for the country where they are operated.

- ARP handling

Mobile stations in the wireless network that are on standby do not answer the ARP requests from other network stations reliably. If 'ARP handling' is activated, the access point takes over this task and answers the ARP requests on behalf of stations that are on standby.

- Broken link detection

The 'Broken link detection' deactivates the WLAN module if the access point loses contact to the LAN.

- Indoor function for WLAN channels

When selecting the frequency band (2.4 or 5 GHz), among other things, you must determine the channels which may possibly be used for transmission. From these possible channels, under automatic channel selection, a LANCOM Wireless Router selects a free channel, for example, in order to avoid interference with other radio signals.

In some countries, there are special regulations on the frequency bands and channels which may be used for WLAN for indoor and outdoor operation. For example, in France, not all available channels in the 2.4 GHz band may be used in outdoor operation. In some countries the DFS procedure is required for outdoor operation in the 5 GHz band in order to avoid interference from radar systems.

With the option 'indoor-only' a LANCOM Wireless Router can be restricted exclusively to operation in closed buildings. This restriction on the other hand allows the channels to be managed more flexibly under automatic channel selection.



Activating the indoor-only function can only be relied upon if the country in which the access point is being operated has been set.



Activating the indoor-only function is only permitted when the access point and all connected clients are located in a closed space.

- Mail address

Information about events in the WLAN is sent to this e-mail address.

## Addition(s) to LCOS 8.00

### Broken link detection

When an access point is not connected to the cabled LAN, it is normally unable to fulfill its primary task, namely the authorization of WLAN clients for access to the LAN. The broken-link detection function allows a device's WLAN to be disabled if the connection to the LAN should fail. Clients associated with that access point are then able to login to a different one (even if it has a weaker signal).

Until LCOS version 7.80, broken-link detection always applied to LAN-1, even if the device was equipped with multiple LAN interfaces. Furthermore, deactivation affected all of the WLAN modules in the device.

With LCOS version 8.00, broken-link detection could be bound to a specific LAN interface.

The settings for the broken-link detection can be found in the following menus:

LANconfig: Wireless-LAN / General / Physical WLAN settings / Operation

WEBconfig: LCOS menu tree / Setup / Interfaces / WLAN / Operational

Operation Radio Performance Point-to-Point Client mode

WLAN interface enabled

WLAN operation mode: Access point

Broken LAN link detection: None

Link LED function: LAN-1

! The link-LED function 'Client signal strength' only makes sense in 'Client mode' WLAN operation. It denotes the signal strength between this station and the connected access point. Signal strength and thus the connection quality is indicated by the blinking frequency. The faster the link LED blinks the better the connection is.

#### ■ Broken link detection

This function allows the WLAN modules in a device to be disabled if the allocated LAN interface has no connection to the LAN.

Possible values:

- No: Broken-link detection is disabled.
- LAN-1 to LAN-n (depending on the LAN interfaces available in the device). All of the WLAN modules in the device will be deactivated if the LAN interface set here should lose its connection to the cabled LAN.

Default:

- No

---

! The interface descriptors LAN-1 to LAN-n stand for the logical LAN interfaces. To make use of this function, the physical Ethernet ports on the device must be set with the corresponding values LAN-1 to LAN-n.

---

! Broken-link detection can also be used for WLAN devices operating in WLAN client mode. With broken-link detection activated, the WLAN modules of a WLAN client are only activated when a connection exists between the relevant LAN interfaces and the cabled LAN.

## 13.5.2 WLAN security

In this part of the configuration, you can place limitations on the communications available to the users in the wireless network. This is done by limiting the data transfer between user groups according to individual stations or the protocol being used. Further, the key for the WLAN encryption is set here.

## General settings

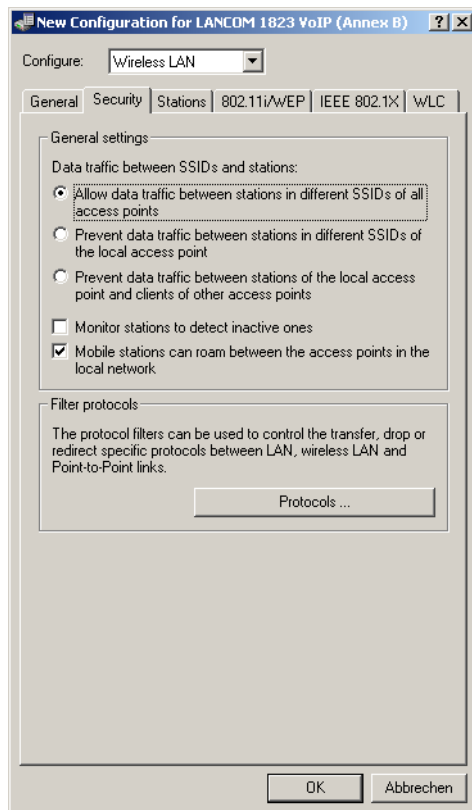

LANconfig: Wireless LAN / Security

- Data traffic between SSIDs and stations

Depending on the application, it may be required that the WLAN clients connected to an access point can—or expressly cannot—communicate with other clients. Communications between clients in different SSIDs can be allowed or stopped with this option. For models with multiple WLAN modules, this setting applies globally to all WLANs and all modules.

! Communications between clients in a logical WLAN is controlled separately by the logical WLAN settings (Inter-Station-Traffic). If the Inter-SSID-Traffic is activated and the Inter-Station-Traffic deactivated, a client in one logical WLAN can communicate with clients in another logical WLAN. This option can be prevented with the VLAN settings or protocol filter.

- Monitor stations to detect stations that are inactive

In particular for public WLAN access points (public spots), the charging of usage fees requires the recognition of stations that are no longer active. Monitoring involves the access point regularly sending packets to logged-in stations. If the stations do not answer these packets, then the charging systems recognizes the station as no longer active.

- Mobile stations can switch between base stations in the local network (roaming)

In addition to controlling the communication between clients, you can also define whether neighboring access points can exchange information via the IAPP. The Inter Access Point Protocol (IAPP) controls communications between access points. The "outgoing" access point receives information that a WLAN client associated with it is switching to another access point, and that the client can be removed from its list.

## Protocol filters

With the protocol filter you can influence the handling of certain protocols during transfer from the WLAN to the LAN. The use of appropriate rules allows the definition of which data packets should be inspected, interfaces for which the filter applies and which action should be performed on the data packets.

LANconfig: Wireless LAN / Security / Protocols

WEBconfig: LCOS menu tree / Setup / LAN bridge / Protocol table

Similar to a firewall rule, a protocol filter consists of two parts:

- The packet conditions defines the conditions that must be satisfied in order for the filter to be applied to a packet.
- The action defines what happens to the packet if the condition is met.

A packet filter is described by the following parameters:

- **Name:** A name of your choice for the filter entry
- **Protocol:** The protocol that this filter is valid for. If '0' is entered as the protocol, the filter applies to **all** packets.
- **Subtype:** The sub-protocol for which this filter is valid. If '0' is entered as the sub-protocol, the filter applies to **all** packets of the protocol entered.
- **Start port** and **end port:** The port range that this filter is to be valid for. If '0' is entered as the start port, this filter will be applied to all ports of the corresponding protocol/sub-protocol. If '0' is entered as the end port, the start port becomes an end port.



Lists of the official protocol and port numbers are available in the Internet under [www.iana.org](http://www.iana.org).

- **Destination MAC address:** The MAC address of the client to which the packet is to be sent. If no destination MAC address is entered, the filter is applied to **all** packets.
- **DHCP source MAC:** Enabling of DHCP address tracking.
  - **Yes:** The rule applies if the source MAC address of the packet is listed in the table under *Status > LAN Bridge Statistics > DHCP Table* as an address which obtained an IP address using DHCP.
  - **No:** The rule applies if this is not the case.
  - **Irrelevant:** The source MAC address is not considered.



❗ If DHCP address tracking is enabled, any IP addresses usually entered are disregarded. Please refer to for further information.

- **IP network** and IP netmask: The IP address of the network mask to which this filter applies. Only those IP packets whose source and destination IP addresses lie within this network are captured by the rule.

If no network is entered, the filter applies to **all** packets.

- **Interface list:** List of the interfaces to which the filter applies.

All of the LAN interfaces, DMZ interfaces, logical WLAN networks and point-to-point connections in the WLAN may be entered as interfaces.

The following examples illustrate how interfaces are specified: 'LAN-1' for the first LAN interface, 'WLAN-2-3' for the third logical WLAN network on the second physical WLAN interface, 'P2P-1-2' for the second point-to-point connection on the first physical WLAN interface.

Groups of interfaces may be specified in the form 'WLAN-1~WLAN-1-6' (logical WLANs 1 to 6 on the first physical WLAN interface) or with a wildcard as 'P2P-1-\*' (all P2P connections on the first physical interface).

❗ Only filter rules with valid entries in the interface list are active. A rule with no specification of the interfaces does not apply to all of them - it is ignored instead.

- **Action:** Action performed for the data packets captured using this rule:
- **Redirect IP address:** Destination IP address for the "Redirect" action

On redirection, the destination IP address of the packets is replaced by the Redirect IP address entered here. Furthermore, the destination MAC address is replaced by the MAC address determined using ARP for the Redirect IP address.

❗ If ARP was unable to determine the destination MAC address, the packet is dropped rather than redirected.

Example:

Name	DHCP source MAC:	Destination MAC address.	Prot.	IP address	IP network:	Subtype	Start port	End port	Interface list	Action	Redirect IP address
ARP	irrelevant	XXXXXXXXXX	0806	0.0.0.0	0.0.0.0	0	0	0	WLAN-1-2	Pass	0.0.0.0
DHCP	irrelevant	XXXXXXXXXX	0800	0.0.0.0	0.0.0.0	17	67	68	WLAN 1-2	Pass	0.0.0.0
TELNET	irrelevant	XXXXXXXXXX	0800	0.0.0.0	0.0.0.0	6	23	23	WLAN 1-2	Redirect	192.168.115
ICMP	irrelevant	XXXXXXXXXX	0800	0.0.0.0	0.0.0.0	1	0	0	WLAN 1-2	Pass	0.0.0.0
HTTP	irrelevant	XXXXXXXXXX	0800	0.0.0.0	0.0.0.0	6	80	80	WLAN 1-2	Redirect	192.168.115

ARP, DHCP, ICMP are allowed to pass, Telnet and HTTP are redirected to 192.168.11.5 and all other packets are rejected.

- Procedure for filter test

If no filter rules are defined for an interface, all packets from and destined to it are transmitted without alteration. As soon as a filter rule has been defined for an interface, all packets to be transferred via this interface are checked prior to being processed.

1. As a first step, the information required for checking is read out of the packets:

- DHCP source MAC:
- Destination MAC address of the packet:
- Protocol, e.g. IPv4, IPX, ARP

- Sub-protocol, e.g. TCP, UDP or ICMP for IPv4 packets, ARP Request or ARP Response for ARP packets
  - IP address and network mask (source and destination) for IPv4 packets
  - Source and destination port for IPv4 TCP or IPv4 UDP packets
2. As a second step, this information is checked against the information from the filter rules. All those rules in which the source **or** destination interface is included in the interface list are considered. Checking of the rules for the individual values is as follows:
- For DHCP source MAC, protocol and sub-protocol, the values read out of the packets are checked for consistency with the values defined in the rule.
  - With IP addresses, the source **and** destination address of the packet are checked to see whether they lie within the range formed by the IP address and the network mask of the rule.
  - Source and destination ports are checked to see whether they lie in the range between start port and end port.

If none of the rule values specified (not filled by wildcards) agree with the values read out of the packet, the rule is not considered applicable and is disregarded. If several rules apply, the most accurate rule action is carried out. Parameters are more accurate the further down the list of parameters they are or the further right they appear in the protocol table.

- 
-  If rules are defined for an interface, but there is no match with one of the rules for a packet from/for this interface, the default rule for this interface is used for the packet. The default rule is pre-configured for each interface with the 'drop' action but this is not visible in the protocol table. To modify a default rule for an interface, a rule with the name 'default-drop' is defined. Besides the interface naming, this rule can only contain wildcats and the required action.

Checking of MAC addresses in packets sent over the respective interface takes on a different form to that with in-coming packets.

- With out-going packets, the source MAC address read out of the packet is checked against the destination MAC address entered in the rule.
  - The destination MAC addresses read out of the packet are then checked to see whether they are listed as currently active DHCP clients.
  - Rules with the 'Redirect' action are ignored if they apply for an interface over which the packet is to be sent.
3. In the third step, the action associated with the applicable rule is carried out.
- Redirect function

With the Redirect action, IPv4 packets can not only be transferred and dropped, they can also be communicated specifically to a particular destination. As a general rule, the destination IP address of the packet is replaced by the Redirect IP address entered. The destination MAC address of the packet is replaced by the MAC address determined by ARP and associated with the Redirect IP address.

In order for the redirected packets to find the correct sender on their "return trip", a dynamic table is compiled with automatic filter rules that apply to packets leaving via this interface. This table can be viewed under `Status > LAN bridge > Connection table`. Rules in this table have a higher priority than other matching rules with the 'Transfer' or 'Drop' actions.

Clients within wireless networks often have one aspect in common: a high degree of mobility. Consequently, clients are not necessarily always connected to the same access point, but frequently change between access points and the related LANs.

The redirect function assists WLAN client applications to automatically find the correct target computer in the LAN. If a WLAN client's HTTP request from a particular logical wireless network is to be always directed to a particular

server in the LAN, a filter setting with the "Redirect" action is set up for the appropriate protocol for the desired logical WLAN interface.

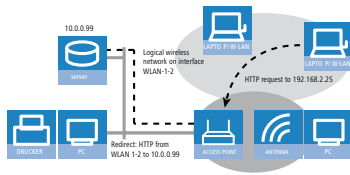

All requests with this protocol from this logical wireless network are automatically redirected to the target server in the LAN. The returning data packets are sent to the senders' addresses and ports according to the entries in the connection statistics, ensuring trouble-free operation in both directions.

- DHCP address tracking

DHCP address tracking keeps a record of which clients have received their IP addresses using DHCP. The relevant information for an interface is automatically maintained in a table under `Status > LAN Bridge Statistics > DHCP Table`. DHCP tracking is enabled on an interface if, for this interface, a minimum of one rule is defined where 'DHCP Source MAC' is set to 'Yes'.

! The number of clients which may be connected to an interface via DHCP can be configured in the Port table under `Setup > LAN Bridge > Port Data`. Setting the entry to '0' means that any number of clients can register at this interface via DHCP. If the maximum number of DHCP clients is exceeded by a further attempt to register, the oldest entry in the list is deleted.

When checking data packets, IP addresses and the IP network mask defined in the rule are not used. Consequently no check is made as to whether the destination IP address of the packet lies within the range specified. Instead, a check is made as to whether the source IP address of the packet matches the IP address assigned to the client via DHCP. The connection of the two IP addresses is made based on the source MAC address.

This check can be used to block clients which have received an IP address via DHCP, but which actually use a different IP address (either intentionally or inadvertently). A rule in which the DHCP Source MAC parameter is set to 'Yes' would not apply since the two addresses do not match. The packet would instead be processed either by other rules or the default rule.

In order for DHCP tracking to work, at least two more rules must be set up for this interface, rules which are not dependent on DHCP tracking. This is necessary since the required DHCP information is not exchanged until the end of DHCP handshake. This is why packets due to be sent beforehand must be allowed by rules which do not use DHCP tracking. These usually included TCP/UDP packets on port 67 and 68 and ARP packets.

! If DHCP tracking is enabled on an interface, packets received on this interface from DHCP servers are automatically dropped.

### 13.5.3 Selecting approved stations for the WLAN

#### Access-control list

With the **Access Control List (ACL)** you can permit or prevent the access to your wireless LAN by individual clients. The decision is based on the MAC address that is permanently programmed into wireless LAN adapters.

! When working with central management of LANCOM Wireless Routers and LANCOM Access Points by LANCOM WLAN Controller, the table of stations is to be found in the area 'WLAN Controller' on the 'Stations' tab and then with the **Stations** button.

Check that the setting 'filter out data from the listed stations, transfer all other' is activated. New stations that are to participate in your wireless network are added with the button 'Stations'.

LANconfig: Wireless LAN / Stations / Stations

WEBconfig: LCOS menu tree / Setup / WLAN / Access list

- MAC address
  - MAC address of the WLAN client for this entry.
- Name
  - WLAN client name for easy identification, e.g. employees.
- Passphrase
  - Passphrase for the WLAN client in networks with 802.11i/WPA/AES-PSK.
- TX bandwidth limit
  - Permitted bandwidth for this WLAN client. Also see
- RX bandwidth limit
  - Permitted bandwidth for this WLAN client. Also see
- VLAN ID
  - This VLAN ID is assigned to packets that are received from the client with the MAC address entered here. In case of VLAN-ID 0, the station is not assigned a specific VLAN ID. Instead, the VLAN ID for the radio cell (SSID) applies.

### 13.5.4 Encryption settings

Access points of the LANCOM range support the most up-to-date methods of encryption and security for data that is transferred via WLAN.

- The IEEE standard 802.11i/WPA stands for the highest degree of security that is currently available for WLAN connections. This standard uses a new encryption procedure (AES-CCM) which, in combination with other methods, achieves levels of security equaled only by VPN connections until now. When using AES-capable hardware (such as the 54-Mbit AirLancer clients and the 54-Mbit LANCOM access points) the transmissions are much faster than with comparable VPN security.
- WEP is also supported to ensure compatibility with older hardware. WEP (**W**ired **E**quivalent **P**rivacy) is the encryption method originally incorporated in the 802.11 standard for the encryption of data in wireless transmission. This method uses keys of 40 (WEP64), 104 (WEP128) or 128 bits (WEP152) in length. A number of security loopholes in WEP have come to light over time, and so the latest 802.11i/WPA methods should be used wherever possible.

! Further information about the 802.11i and WPA standards are available under .

## WPA and private WEP settings

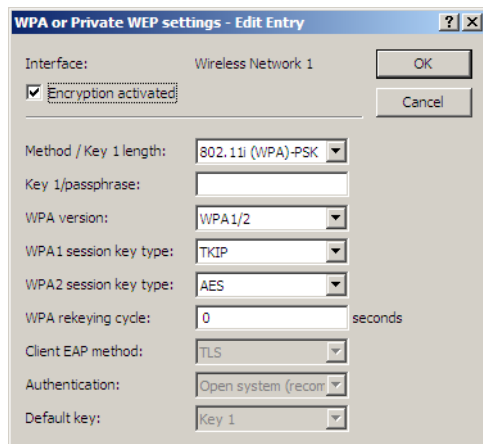

LANconfigWireless LAN / 802.11i/WEP / WPA or Private WEP settings

WEBconfig: LCOS menu tree / Setup / Interfaces / WLAN / Encryption

### ■ Method/key 1 length

Set the encryption method to be used here.

- 802.11i (WPA)-PSK – Encryption according to the 802.11i standard offers the highest security. The 128-bit AES encryption used here offers security equivalent to that of a VPN connection. Select this setting if no RADIUS server is available and authentication is based on a pre-shared key.
- 802.11i (WPA)-802.1x – If authentication is handled by a RADIUS server, select the option '802.11i (WPA)-802.1x'. When using this setting, additionally ensure that the RADIUS server is configured in the 802.1x settings.
- WEP 152, WEP 128, WEP 64 – encryption according to the WEP standard with key lengths of 128, 104 or 40 bits respectively. This setting is only to be recommended when the hardware used by the WLAN client does not support the modern method.
- WEP 152-802.1x, WEP 128-802.1x, WEP 64-802.1x – encryption according to the WEP standard with key lengths of 128, 104 or 40 bits respectively, and with additional authentication via 802.1x/EAP. This setting is also only to be recommended when the hardware used by the WLAN client does not support the 802.11i standard. The 802.1x/EAP authentication offers a higher level of security than WEP encryption alone.

### ■ Key 1/passphrase

In line with the encryption method activated, you can enter a special WEP key for the respective logical WLAN interface or a passphrase when using WPA-PSK:

- The passphrase, or the 'password' for the WPA-PSK method, is entered as a string of at least 8 and up to 63 ASCII characters.



Please be aware that the security of this encryption method depends on the confidential treatment of this passphrase. Passphrases should not be made public to larger circles of users.

- The WEP key 1, that applies only to its respective logical WLAN interface, can be entered in different ways depending on the key length. Rules of the entry of the keys can be found in the description of the WEP group key.

### ■ WPA version

WPA version for encryption offered by the access point to the WLAN clients.

- WPA1: WPA1 only
- WPA2: WPA2 only
- WPA1/2: WPA1 and WPA2 in one SSID (radio cell)

### ■ WPA1 session key type

If '802.11i (WPA)-PSK' has been entered as the encryption method, the procedure for generating a session or group key for WPA 1 can be selected here:

- AES – the AES method will be used.
- TKIP – the TKIP method will be used.
- AES/TKIP – the AES method will be used. If the client hardware does not support the AES method, TKIP will be used.

- WPA 2 session key type

Procedure for generating a session or group key for WPA 2.

- WPA rekeying cycle

A 48-bit long initialization vector (IV) impedes attackers in their attempts to calculate the WPA key. The true key consisting of the IV and WPA key only repeats every 16 million packets. In high-traffic WLANs, the key is repeated only after several hours. To avoid repetition of the key, WPA automatically renegotiates the key at regular intervals. This takes place before repetition of the key.

Enter a value in seconds after which the key is renegotiated.

The standard value is '0' and the key is not negotiated in advance.

- Client EAP method

In WLAN client operating mode, LANCOM Access Points can authenticate themselves to another access point using EAP/802.1X. To activate the EAP/802.1X authentication in client mode, the client EAP method is selected as the encryption method for the first logical WLAN network.

Note that the selected client EAP method must match the settings of the access point that the LANCOM Access Point is attempting to log onto.



In addition to setting the client EAP method, also be sure to observe the corresponding setting for the WLAN client operation mode! The client EAP method setting has no function on logical WLAN networks other than WLAN 1.

- Authentication

If the encryption method was set as WEP encryption, two different methods for the authentication of the WLAN client are available:

- The 'Open system' method does not use any authentication. The data packets must be properly encrypted from the start to be accepted by the access point.
- With the 'Shared key' method, the first data packet is transmitted unencrypted and must be sent back by the client correctly encrypted. This method presents potential attackers with at least one data packet that is unencrypted.

- Default key

If WEP encryption is selected, the access point can select from four different WEP keys for each logical WLAN interface:

- Three WEP keys for the physical interface
- An additional WEP key particular to each logical WLAN interface

The private WEP settings are used to set the additional key for each logical WLAN interface (see 'Key 1/passphrase'). You should also select which of the four keys is currently to be used for the encryption of the data (default key). This setting can be used to change the key frequently, so increasing security.

Rules of the entry of the keys can be found in the description of the WEP group key .

## WEP group keys

The WEP method uses keys of 40 (WEP64), 104 (WEP128) or 128 bits (WEP152) in length. Each WLAN interface has four WEP keys: a special key for each logical WLAN interface and three common group WEP keys for each physical WLAN interface.

! If 802.1x/EAP is in use and the 'dynamic key generation and transmission' is activated, the group keys from 802.1x/EAP will be used and are consequently no longer available for WEP encryption.

Rules of the entry of the keys can be found in the description of the WEP group key .

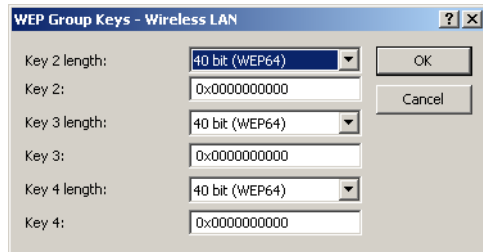

LANconfigWireless LAN / 802.11i/WEP / WEP group keys

WEBconfig: LCOS menu tree / Setup / Interfaces / WLAN / Group keys

### Rules for entering WEP keys

WEP keys can be entered as ASCII characters or in hexadecimal form. The hexadecimal form begins with the characters '0x'. The keys have a length depending on the WEP method:

Method	ASCII	HEX
WEP 64	5 characters Example: 'aR45Z'	10 characters Example: '0x0A5C1B6D8E'
WEP 128	13 characters	26 characters
WEP 152	16 characters	32 characters

The ASCII character set includes the characters '0' to '9', 'a' to 'z', 'A' to 'Z' and the following special characters:  
! " # \$ % & ' ( ) \* + , - . / : ; < = > ? @ [ \ ] ^ \_ ' { | } ~

The HEX form uses the numbers '0' to '9' and the letters 'A' to 'F' to display each character as a character pair, which is why twice the number of characters is required to display a HEX key.

Select the length and the format (ASCII or HEX) of the key depending on the best option available in the wireless network cards that register with your WLAN. If the encryption in an access point is set to WEP 152, some clients may not be able to log into the WLAN as their hardware does not support the key length.

## 13.5.5 The physical WLAN interfaces

In addition to the general WLAN parameters, a variety of settings apply specifically to each WLAN module in the access point.

K.

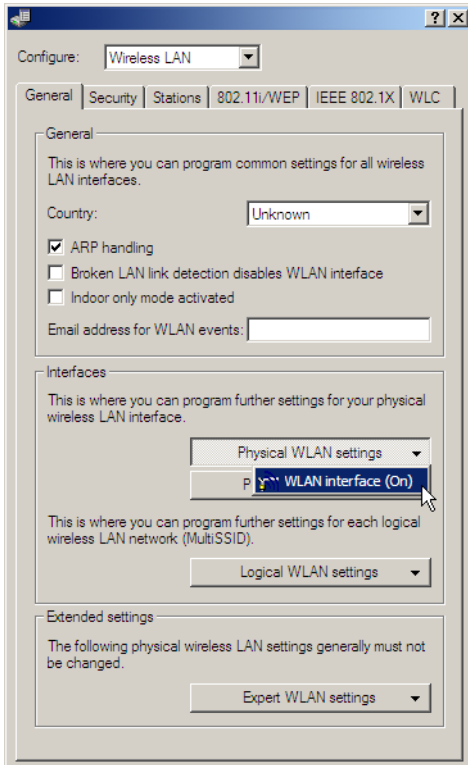

### Operating settings

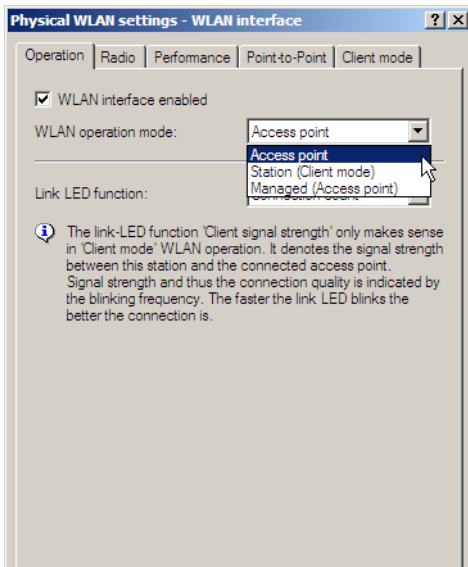

LANconfig: Wireless LAN / General / Physical WLAN settings / Operation

WEBconfig: LCOS menu tree / Setup / Interfaces / WLAN / Operational

- WLAN operating modes

LANCOM Access Points can be operated in various operating modes:

- As an access point, it forms the link between WLAN clients and the cabled LAN.



- In client mode, the device itself locates the connection to another access point and attempts to register with a wireless network. In this case the device serves to link a cabled network device to an access point over a wireless connection.
- As a managed Access Point, the device searches for a central WLAN-Controller from which it can obtain a configuration.

If the WLAN interface is not required, it can be completely deactivated.

- Link LED function

When setting up point-to-point connections or operating the device as a WLAN client, the best possible positioning of the antennas is facilitated if the signal strength can be recognized at different positions. The WLAN link LED can be used for displaying the signal quality during the set-up phase. In the corresponding operation mode, the WLAN link LED blinks faster the better the reception quality in the respective antenna position is.

- Number of connections: In this operation mode, the LED uses "inverse flashing" in order to display the number of WLAN clients that are logged on to this access point as clients. There is a short pause after the number of flashes for each client. Select this operation mode when you are operating the LANCOM Wireless Router in access point mode.
- Client signal strength: In this operation mode, this LED displays the signal strength of the access point with which the LANCOM Access Point has registered itself as a client. The faster the LED blinks, the better the signal. Select this operation mode only if you are operating the LANCOM Access Point in client mode.
- P2P1 to P2P6 signal strength: In this operation mode, the LED displays the signal strength of respective P2P partner with which the LANCOM Access Point forms a P2P path. The faster the LED blinks, the better the signal.

## Radio settings

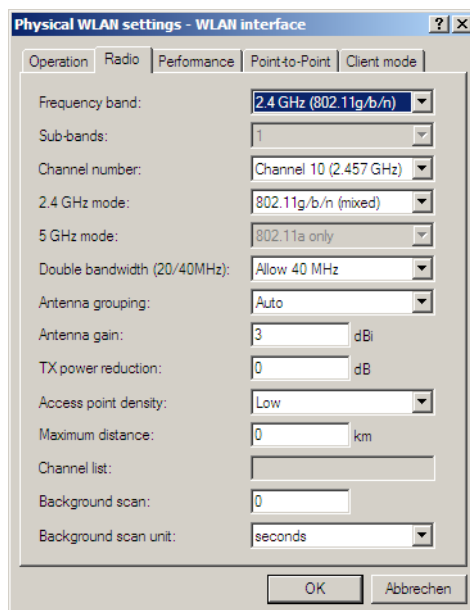

LANconfig: Wireless LAN / General / Physical WLAN settings / Radio

WEBconfig: LCOS menu tree / Setup / Interfaces / WLAN / Radio settings

- Frequency band, Subband

When selecting the frequency band on the 'Radio' tab under the physical interface settings, you decide whether the WLAN module operates in the 2.4 GHz or in the 5 GHz band (also see ), and thus the available radio channels.

In the 5 GHz band, a subband can also be selected which is linked to certain radio channels and maximum transmission powers.

- 
-  In some countries, the use of the DFS method for automatic channel selection is a legal requirement. Selecting the subband also defines the radio channels that can be used for the automatic channel selection.

With the DFS method (Dynamic Frequency Selection) an unused frequency is automatically selected, for example, to avoid interference from radar systems or to distribute WLAN devices as evenly as possible over the entire frequency band. After switching on or booting, the device randomly selects one of the available channels (e.g. based on the country settings). It checks whether radar signals exist on this channel, and whether it is already in use by another WLAN. This scan procedure repeats until a channel is found that is free of radar signals and which has the lowest possible number of other networks. The selected channel is then monitored for radar signals for a further 60 seconds. For this reason, data traffic may be interrupted for a period of 60 seconds while the frequencies are scanned for a free channel.

To avoid these pauses in data transmission every time the channel is changed, LANCOM devices carry out the scan **before** a channel is chosen. Information about scanned channels is stored to an internal database.

- Was a radar signal detected on the channel?
- How many other networks were found on the channel?

This database helps the WLAN device to select a channel from the list that is free of radar signals and that has the lowest number of other networks (the operating channel). After the channel has been selected, data transmission can continue immediately without any waiting.

- The "blacklist" in the database stores the channels to be blocked due to the detection of radar signals. These entries are removed from the list every 30 minutes in order to keep the information up to date.
- The "whitelist" in the database stores the channels where no radar was detected. These entries remain valid for 24 hours, although if radar signals be detected in the meantime, an entry is made to the blacklist.

The access point generally uses the operating channel selected after the first scan permanently. Connections can now be operated for any length of time on the channel selected by the DFS algorithm until either a radar signal is detected or the radio cell is restarted (e.g. by changing the device configuration, firmware upload, or restart).

When is it necessary to carry out a new 60-second scan?

- The device is switched on or cold-started. Under these circumstances the database is empty. The device cannot select a channel from the whitelist, and so a scan has to be carried out.
- Within the first 24 hours of scanning, it becomes necessary to switch channels because a radar signal is detected within range of the access point. In this case, the access point can refer to alternatives in the whitelist. It then informs associated WLAN clients and/or P2P partners of the new operating channel and switches to this channel. This process takes place within about a second, so the switch can be considered to be uninterrupted.
- The device is in operation for 24 hours already, and then a channel switch becomes necessary. Entries in the whitelist are out of date and thus discarded. The access point has no alternative channel to which it can switch directly. In this case the database requires new information from a scan and WLAN operation is interrupted for one minute.

- 
-  To avoid having the 60 second pause at an inconvenient time, you can set the time of the scan and thus the database update. Do this with WEBconfig or telnet in the menu `Setup/Interfaces/WLAN/Radio settings`. To define the time you can use the options provided by cron commands, e.g. '1,6,13' to force a DFS scan at 01:00h, 06:00h or 13:00h, or '0-23/4' for a DFS scan between 0:00h and 23:00h every 4 hours. Forced DFS scans require that the device is set with the correct system time.

The ETSI standard 301 893 version 1.4.1 is the latest set of regulations concerning the operation of 5-GHz wireless LANs. In the context of the wireless LAN modules used in the LANCOM Wireless Routers and LANCOM Access Points, this standard is also referred to as DFS 2.

This standard makes tougher demands on the radar detection patterns used when operating 5-GHz WLANs. The standard applies to all devices brought into circulation after April 01, 2008. Devices brought into circulation before this date do not have to meet this standard. In particular devices with older WLAN chips (two- or three-chip modules) do not have to meet this standard and, as such, do not have to be upgraded.

LANCOM Systems supplies LCOS firmware of the versions 7.30 (for the current Wireless Routers and Access Points) and 7.52 (for LANCOM Wireless L-310agn and LANCOM Wireless L-305agn) with DFS 2 support. These firmware versions have different threshold values for radar-pattern recognition than with the former DFS.

⚠ In principle the operator of the WLAN is responsible for maintaining the new ETSI standards. For this reason LANCOM Systems recommends that you perform an update to a firmware version with DFS 2 support.

#### ■ Channel number

The radio channel selects a portion of the conceivable frequency band for data transfer.

⚠ In the 2.4-GHz band, two separate wireless networks must be at least three channels apart to avoid interference.

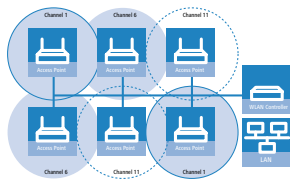

#### ■ 2.4-GHz mode

Three different wireless standards are based on the 2.4-GHz band: IEEE 802.11b, IEEE 802.11g and IEEE 802.11n. If 2.4 GHz is selected as the operating frequency, the compatibility mode can be selected in addition.

⚠ Please observe that clients supporting only the slower standards may not be able to register with the WLAN if compatibility mode is set to a high value.

The 802.11g/n compatibility mode offers the highest possible speeds and yet also offers the 802.11b standard so that slower clients are not excluded. In this mode, the WLAN module in the access point principally works with the faster standard and falls back on the slower mode should a client of this type log into the WLAN.

In principle 802.11n is backwardly compatible to the previous IEEE 802.11b/g wireless LAN standards, although not all 802.11n functions are supported in this mode.

In the 2.4 GHz band you can allow operation in accordance with 802.11b/g/n either exclusively or in various mixed modes. When 802.11b is supported you can also select whether only 11 Mbps mode or the older 2 Mbps should be supported.

⚠ Compatibility is always achieved at the expense of performance. It is therefore recommended to allow only those modes of operation that are absolutely necessary for the wireless LAN clients in use.

#### ■ 5-GHz mode

Using two neighboring, vacant channels for wireless transmissions can increase the transfer speeds up to 108 Mbps. With the base station in the 108Mbit/s Turbo mode, only those WLAN clients that also support the 108Mbit/s Turbo mode can connect to this base station.

In the 5 GHz band you can choose to allow either greenfield mode (802.11n only) or mixed operation with 802.11a. Greenfield mode should be chosen if there are only 802.11n devices in operation in a network, as these guarantee the highest possible throughput rates.

#### ■ Double bandwidth (20/40 MHz)

A wireless LAN module normally uses a frequency range of 20 MHz in which data to be transmitted is modulated to the carrier signals. 802.11a/b/g use 48 carrier signals in a 20 MHz channel. The use of double the frequency range of 40 MHz means that 96 carrier signals can be used, resulting in a doubling of the data throughput.

802.11n can use 52 carrier signals in one 20 MHz channel for modulation and up to 108 in a 40 MHz channel. The use of the 40 MHz option for 802.11n therefore means a performance gain of more than double.

#### ■ Antenna grouping

LANCOM Access Points with 802.11 support can use up to three antennas for transmitting and receiving data. Using several antennas with 802.11n can have different purposes:

- Improved data throughput: Using "spatial multiplexing" allows parallel data streams to be implemented to transmit double the amount of data.
- Improving wireless coverage: Cyclic shift diversity (CSD) can be used to transmit a radio signal in different phases. This reduces the risk of the signal being erased at certain points in the radio cell.

Depending on the application the use of the antennas can be set:

- When using the device in access point mode to connect wireless LAN clients it is generally recommended to use all three antennas in parallel in order to achieve good network coverage.
- To work with 2 parallel data streams; for example for point-to-point links with an appropriate dual slant antenna, the antenna ports 1 + 2 **or** 1 + 3 are used. The unused antenna port is deactivated.
- For applications with only one antenna (for example an outdoor application with just one antenna) the antenna is connected to port 1 and ports 2 and 3 are deactivated
- The "Auto" setting means that all available antennas are used

Please note the following when connecting antennas:

Antenna connector 1 must always be used. Depending on the mounting and cabling, the second antenna may be connected either to connector 2 or connector 3.

The configuration of the device software must agree with the actual antenna connections.

- Diversity settings

The diversity settings specify which antennas should be used for transmission and for reception:

- 'Transmit via the primary antenna only' (RX diversity): In this default setting, the antenna connected to the access point's main connector is used for data transmission. For reception (RX), the antenna with the best signal is selected (at Main or AUX).
- 'Automatically select the best antenna for transmission' (TX and RX diversity): If the diversity function is used for transmission (TX) as well, the antenna with the strongest signal is taken.
- 'Send via the primary antenna and receive via the secondary antenna' (no diversity): The main antenna only is used for transmission, and for reception the antenna at the AUX connector is preferred. Using this alternative, high-performance antennas that are legally prohibited from transmitting can be used for reception.

- Antenna gain, transmission power reduction

Where the transmission power of an antennae exceeds the levels permitted in the country of operation, the power must be attenuated accordingly.

- The field 'Antenna gain' is for the gain of the antenna minus the actual cable loss. For an AirLancer Extender O-18a antenna with a gain of 18dBi and a 4m cable with a loss of 1dB/m, the 'Antenna gain' would be entered as  $18 - 4 = 14$ . This value for true antenna gain is dynamically used to calculate and emit the maximum permissible power with regards to other parameters such as country, data rate and frequency band.
- In contrast to this, the entry in the field 'Tx power reduction' causes a static reduction in the power by the value entered, and ignores the other parameters. Also see .



The transmission power reduction simply reduces the emitted power. The reception sensitivity (reception antenna gain) remains unaffected. This option is useful, for example, where large distances have to be bridged by radio when using shorter cables. The reception antenna gain can be increased without exceeding the legal limits on transmission power. This leads to an improvement in the maximum possible range and, in particular, the highest possible data transfer rates.

- Access point density

The more access points there are in a given area, the more the reception areas of the antennae intersect. Information on 'access point density' is sent with the beacons for processing by older Agere clients.

- Maximum distance

Large distances between transmitter and receiver give rise to increasing delays for the data packets. If a certain limit is exceeded, the responses to transmitted packets no longer arrive within an acceptable time limit. The entry for maximum distance increases the wait time for the responses. This distance is converted into a delay which is acceptable for wireless communications.

- Background scan interval

If a value is entered here, the LANCOM Wireless Router searches the frequencies in the active band that are currently not in use in cycles within this interval in order to find available access points.

- The background scan function is usually deployed for rogue AP detection for the LANCOM Wireless Router in access point mode. This scan interval should correspond to the time span within which unauthorized access points should be recognized, e.g. 1 hour.
- Conversely, for the LANCOM Wireless Router in client mode, the background scan function is generally used for improved mobile WLAN client roaming. In order to achieve fast roaming, the scan time is limited here, for example, to 260 seconds.
- When the background scan time is '0' the background scanning function is deactivated.

- Time unit for background scanning

The background scan interval sets the time period between searches by a Wireless Router or Access Point for third-party WLAN networks within range.

The time interval allows the entered value to be defined in milliseconds, seconds, minutes, hours or days.

! To avoid adverse effects on data transfer rates, the interval between channel scans in access-point mode should be at least 20 seconds. Lesser values will be corrected to this minimum value automatically. For example, with 13 channels to scan in the 2.4GHz band, one scan of the full spectrum takes at least  $13 \times 20s = 260$  seconds.

! Background scanning can be limited to a lower number of channels when indoor mode is activated. This allows roaming for the mobile LANCOM Wireless Router in client mode to be improved even further.

## Performance

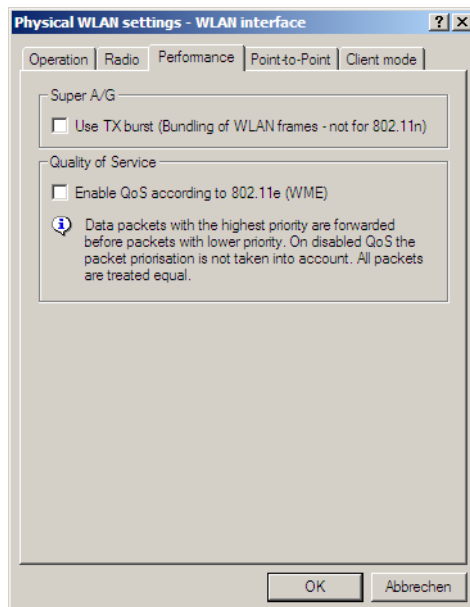

LANconfig: Wireless LAN / General / Physical WLAN settings / Performance

WEBconfig: LCOS menu tree / Setup / Interfaces / WLAN / Performance

- TX burst

Enables/prevents packet bursting for increasing throughput. Bursting leads to less fairness on the medium.

- Hardware compression

Allows or prohibits the hardware packet compression.

- QoS according to 802.11e

With the extension to the 802.11 standard, 802.11e, Quality of Service can be provided for transfers via WLAN. Among others, 802.11e supports the prioritization of certain data-packet types. This extension is an important basis for the use of voice applications in WLANs (Voice over WLAN, VoWLAN). The WiFi alliance certifies products that support Quality of Service according to 802.11e, and refer to WMM (WiFi Multimedia, formerly known as WME or Wireless Multimedia Extension). WMM defines four categories (voice, video, best effort and background) which make up separate queues to be used for prioritization. The 802.11e standard sets priorities by referring to the VLAN tags or, in the absence of these, by the DiffServ fields of IP packets. Delay times (jitter) are kept below 2 milliseconds, a magnitude which is inaudible to the human ear. 802.11e controls access to the transfer medium with EDCF, the Enhanced Distributed Coordination Function.



Priorities can only be set if the WLAN client and the access point both support 802.11e or WMM, and also if the applications are able to mark the data packets with the corresponding priorities.

## Point-to-point connections

Access points are not limited to communications with mobile clients; they can also transfer data from one access point to another.

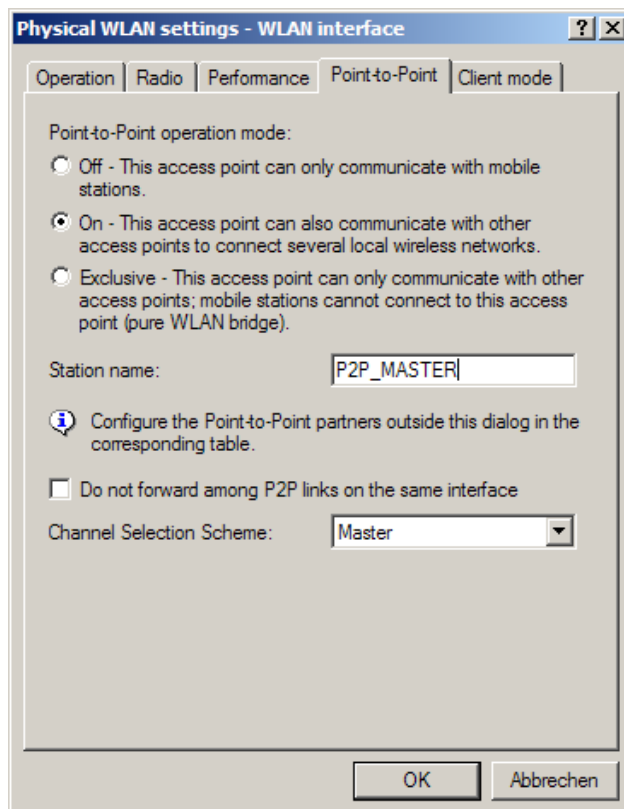

LANconfig: Wireless LAN / General / Physical WLAN settings / Point-to-point

WEBconfig: LCOS menu tree / Setup / Interfaces / WLAN / Interpoint settings

- Point-to-point operation mode

- 'Off': The access point only communicates with mobile clients
- 'On': The access point can communicate with other access points and with mobile clients

- 'Exclusive': The access point only communicates with other access points
- Station name
 

For this physical WLAN interface, enter a name which is unique in the WLAN: This name can be used by other WLAN devices to connect this base station over point-to-point.

You can leave this field empty if the device has only one WLAN interface and already has a device name which is unique in the WLAN, or if the other base stations identify this interface by means of the WLAN adapter's MAC address.
- Do not forward packets between P2P links on the same interface
 

Allows or prohibits the transmission of packets between P2P links on the same WLAN interface
- Channel selection scheme
 

In the 5-GHz band, the automatic search for vacant WLAN channels can lead to several simultaneous test transmissions from multiple access points, with the result that they do not find each other. This stalemate situation can be avoided with the appropriate "Channel selection scheme".

Thus it is recommended for the 5GHz band that one central access point should be configured as 'Master' and all other point-to-point partners should be configured as 'Slave'. In the 2.4GHz band, too, this setting simplifies the establishment of point-to-point connections if the automatic channel search is activated.

  - Master: This access point takes over the leadership when selecting a free WLAN channel.
  - Slave: All other access points will search for a channel until they have found a transmitting Master.



The purpose of this area is to define general P2P parameters only—the actual connections to remote WLAN stations themselves are defined under the following paths: LANconfigWireless LAN / General / Point to point partners WEBconfig: Setup / Interfaces / WLAN Interpoint peers

## Client mode

If the LANCOM Router device is operating as a client, the tab 'Client mode' can be used for further settings that affect the behavior as a client.

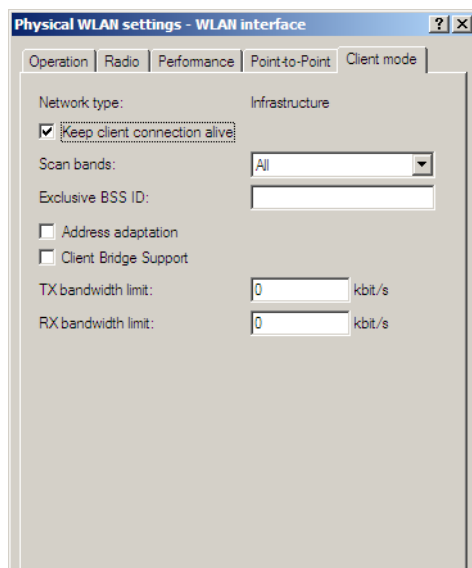

LANconfig: Wireless LAN / General / Physical WLAN settings / Client mode

WEBconfig: LCOS menu tree / Setup / Interfaces / WLAN / Client modes

- Keep client connection alive

This option ensures that the client station keeps the connection to the access point alive even if the connected devices are not exchanging any data packets. If this option is disabled, the client station is automatically logged off the wireless network if no packets are transferred over the WLAN connection within a specified time.

- Scan bands

This defines whether the client station scans just the 2.4 GHz, just the 5 GHz, or all of the available bands for access points.

- Preferred BSS ID

If the client station is to log onto one particular access point only, the MAC address of the WLAN module in this access point can be entered here.

- Address adaptation

In client mode, the client station normally replaces the MAC addresses in data packets from the devices connected to it with its own MAC address. The access point at the other end of the connection only ever “sees” the MAC address of the client station, not the MAC address of the computer(s) connected to it.

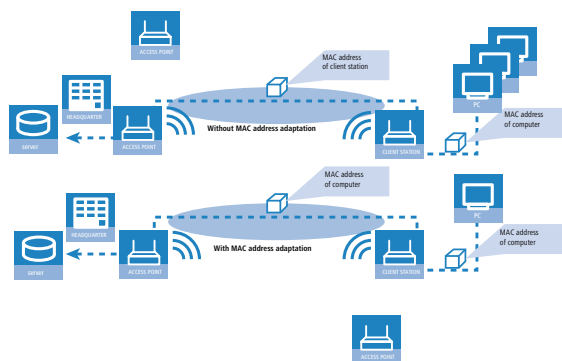

In some installations it may be desirable for the MAC address of a computer to be transmitted to the access point and not the MAC address of the client station. The option ‘Address adaptation’ prevents the MAC address from being replaced by the client station. Data packets are transferred with their original MAC addresses—in the WLAN, the Access Point takes the client's MAC address.

⚠ Address adaptation only works when just **one** computer is connected to the client station.

- Client-bridge support

Whereas address adaptation allows only the MAC address of a **single** attached device to be visible to the access point, client-bridge support provides transparency in that all MAC addresses of the LAN stations behind the client stations are transferred to the access point.

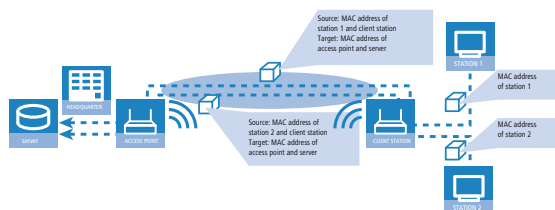

Furthermore, the three MAC addresses usual in client mode are not used for this operating mode (in this example for server, access point and client station), but rather four addresses as with point-to-point connections (the fourth is the MAC address of the station in the LAN of the client station). The fully transparent connection of a LAN to the client station allows targeted transmission of data packets in the WLAN and hence functions such as TFTP downloads, initiated by a broadcast.

The client-bridge mode offers the following advantages:

- Unlike the “normal” client mode, address translation (masking) in the client station is omitted.



- In relation to point-to-point connections, the occasionally undesirable entry of MAC addresses or station names is omitted. Furthermore, the client-bridge mode allows more than six connections (limitation with P2P) to be set up.
- The client station can roam, which is not possible with point-to-point (this applies both to the client-bridge mode and to the standard client mode).

 Client-bridge mode can only be used between two LANCOM devices. Likewise, the use of the client-bridge mode must be enabled in the settings for the logical network of the access point.

### 13.5.6 Point-to-point peers

Up to six point-to-point connections can be activated for each WLAN module.

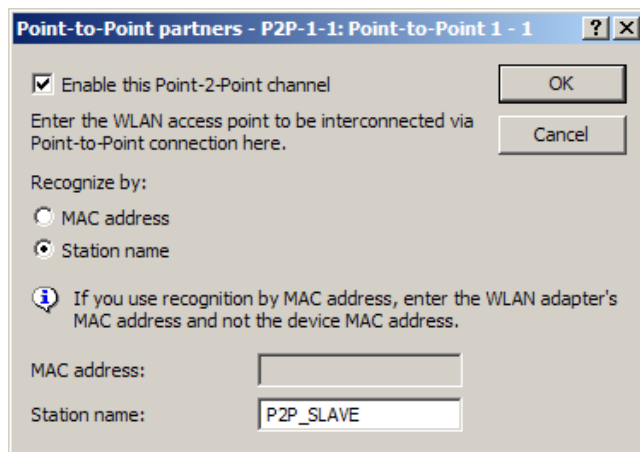

LANconfigWireless LAN / General / Point to point partners

WEBconfig: Setup / Interfaces / WLAN Interpoint peers

- Recognize by  
Here you select the characteristics to be used to identify the P2P peer.
- MAC address  
MAC address of the P2P remote station.
- Station name  
Station name of the P2P remote station.

 If you work with detection by MAC address, enter the MAC address of the WLAN adapter here and not that of the device itself.

### 13.5.7 The logical WLAN interfaces

Every physical WLAN interface can support up to eight different logical wireless networks (Multi-SSID). Parameters can be defined specifically for each of these networks, without the need of additional access points.

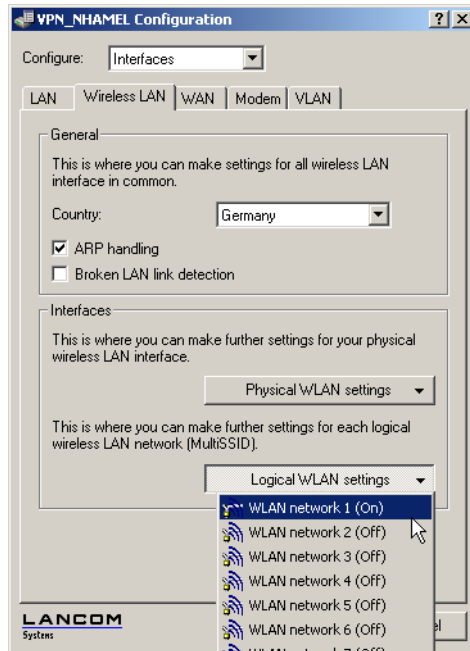

#### Network settings

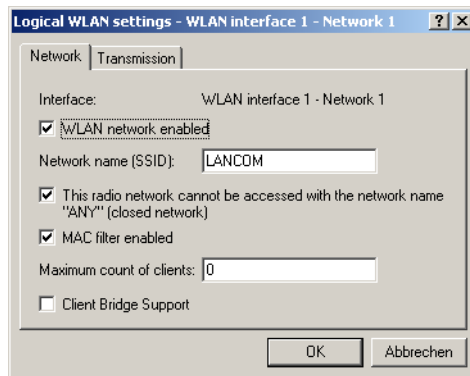

LANconfig: Wireless LAN / General / Logical WLAN settings / Network

WEBconfig: LCOS menu tree / Setup / Interfaces / WLAN / Network

- Wireless LAN enabled/operating

This switch allows the logical WLAN to be activated/deactivated separately.

- Network name (SSID)

Define a unique SSID (the network name) for each of the logical wireless LANs required. Only network cards that have the same SSID can register with this wireless network.

- Suppress SSID broadcast

You can operate your wireless LAN either in public or private mode. A wireless LAN in public mode can be contacted by any mobile station in the area without the SSID being named. By suppressing SSIDs in the broadcasts, you place

your wireless LAN into a privacy mode. In this operation mode, mobile stations that do not know the network name (SSID) are excluded from taking part in the wireless LAN.

Activate the suppression of SSID broadcasting if you wish to prevent WLAN clients from registering with your network without naming the SSID.

- MAC filter enabled

The MAC addresses of the clients that are allowed to associate with an access point are stored in the MAC filter list (**Wireless LAN / Stations / Stations**). The 'MAC filter activated' switch can be used to switch off the use of the MAC filter list for individual logical networks.

! Use of the MAC filter list is required for logical networks in which the clients register via LEPS with an individual passphrase. The passphrase used by LEPS is also entered into the MAC filter list. The MAC filter list is always consulted for registrations with an individual passphrase, even if this option is deactivated.

- Maximum number of clients

Here you set the maximum number of clients that may associate with this access point. Additional clients wanting to associate will be rejected.

- Client-bridge support

Enable this option for an access point if you have enabled the client-bridge support for a client station in WLAN client mode.

! Client-bridge mode can only be used between two LANCOM devices.

## Transmission settings

Details for the data transfer over the logical interface are set on the 'Transmission' tab.

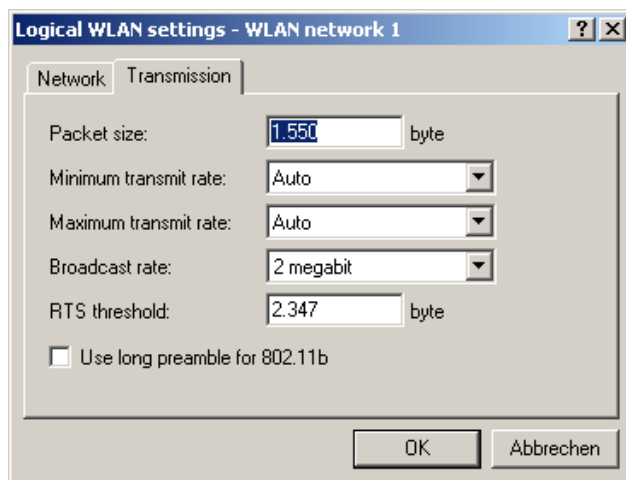

LANconfig: Wireless LAN / General / Logical WLAN settings / Transmission

WEBconfig: LCOS menu tree / Setup / Interfaces / WLAN / Transmission

- Packet size

Smaller data packets cause fewer transmission errors than larger packets, although the proportion of header information in the traffic increases, leading to a drop in the effective network load. Increase the factory value only if your wireless network is largely free from interference and very few transmission errors occur. Reduce the value to reduce the occurrence of transmission errors.

- Minimum and maximum transmit rate

The access point normally negotiates the data transmission speeds with the connected WLAN clients continuously and dynamically. The access point adjusts the transmission speeds to the reception conditions. As an alternative,

you can set fixed values for the minimum and maximum transmission speeds if you wish to prevent the dynamic speed adjustment.

- Modulation Coding Scheme (MCS)

A specific MCS number denotes a unique combination from the modulation of the individual carriers (BPSK, QPSK, 16QAM, 64QAM), coding rate (i. e. proportion of error correction bits in the raw data and number of spatial streams. 802.11n uses this term instead of the term "data rate" used in older wireless LAN standards because data rate is no longer an unequivocal description.

MCS index	Data streams	Modulation	Coding rate	Data throughput (GI=0.4 $\mu$ s, 40 MHz)
0	1	BPSK	1/2	15
1	1	QPSK	1/2	30
2	1	QPSK	3/4	45
3	1	16QAM	1/2	60
4	1	16QAM	3/4	90
5	1	64QAM	1/2	120
6	1	64QAM	3/4	135
7	1	64QAM	5/6	150
8	2	BPSK	1/2	30
9	2	QPSK	1/2	60
10	2	QPSK	3/4	90
11	2	16QAM	1/2	120
12	2	16QAM	3/4	180
13	2	64QAM	1/2	240
14	2	64QAM	3/4	270
15	2	64QAM	5/6	300

The MCS selection therefore indicates the type and minimum or maximum number of modulation parameters that should be used for one or two spatial data streams. Within these limits, the appropriate MCS is selected when the connection is established depending on the current conditions and may be adapted during the connection if required. This also defines the maximum attainable data throughput, indicated in the last column of the table (here for the short guard interval  $GI = 0.4 \mu$ s using the 40 MHz channel).

- Broadcast rate

The defined broadcast rate should allow the slowest clients to connect to the WLAN even under poor reception conditions. A higher value should only be set here if all clients are able to connect "faster".

- Number of spatial streams

The spatial multiplexing function allows several separate data streams to be transmitted over separate antennas in order to increase data throughput. The use of this function is only recommended when the remote device can process the data streams with corresponding antennas.

 With the 'Auto' setting all spatial streams that are supported by the wireless LAN module in question are used.

- RTS threshold

The RTS threshold prevents the occurrence of the "hidden station" phenomenon.



Here, the three access points , , and are positioned such that no direct wireless connection between the two outer devices is possible. If sends a packet to , is not aware of this as it is outside of 's coverage area. may also try, during the transmission from , to send a packet to as well, because has no knowledge of the medium (in this case the wireless connection) being blocked. A collision results and neither of the transmissions from nor to will be successful. The RTS/CTS protocol is used to prevent collisions.



To this end, precedes the actual transmission by sending an RTS packet to , that answers with a CTS. The CTS sent by is now within "listening distance" of , so that can wait with its packet for . The RTS and CTS signals each contain information about the time required for the transmission that follows.

A collision between the very short RTS packets is improbable, although the use of RTS/CTS leads to an increase in overhead. The use of this procedure is only worthwhile where long data packets are being used and the risk of collision is higher. The RTS threshold is used to define the minimum packet length for the use of RTS/CTS. The best value can be found using trial and error tests on location.



The RTS/CTS threshold value also has to be set in the WLAN client, as far as the driver and/or operating system allow this.

- Long preamble for 802.11b

Normally, the clients in 802.11b mode negotiate the length of the preamble with the access point. "Long preamble" should only be set when the clients require this setting to be fixed.

- Short guard interval

This option is used to reduce the transmission pause between two signals from 0.8  $\mu$ s (default) to 0.4  $\mu$ s (short guard interval). This increases the effective time available for data transmission and thus the data throughput. However, the wireless LAN system becomes more liable to disruption that can be caused by interference between two consecutive signals.

The short guard interval is activated in automatic mode, provided that the remote station supports this. Alternatively the short guard mode can be switched off.

- Frame aggregation

Frame aggregation is used to combine several data packets (frames) into one large packet and transmit them together. This method serves to reduce the packet overhead, and the data throughput increases.

Frame aggregation is not suitable when working with mobile receivers or time-critical data transmissions such as voice over IP.

- Hard retries

This value defines the number of times that the hardware should attempt to send packets before a Tx error message is issued. Smaller values mean that a packet which cannot be sent blocks the sender for less time.

- Soft retries

If the hardware was unable to send a packet, the number of soft retries defines how often the system repeats the attempt to transmit.

The total number of attempts is thus (soft retries + 1) \* hard retries.

The advantage of using soft retries at the expense of hard retries is that the rate-adaption algorithm immediately begins the next series of hard retries with a lower datarate.

## Addition(s) to LCOS 8.62

### New parameter for WLAN client signal strength

LCOS version 8.62 now optionally evaluates the signal strengths of wireless LAN clients when they logon.

### Additions to LANconfig

## Network settings

LANconfig:Wireless LAN > General > Logical WLAN settings > Network

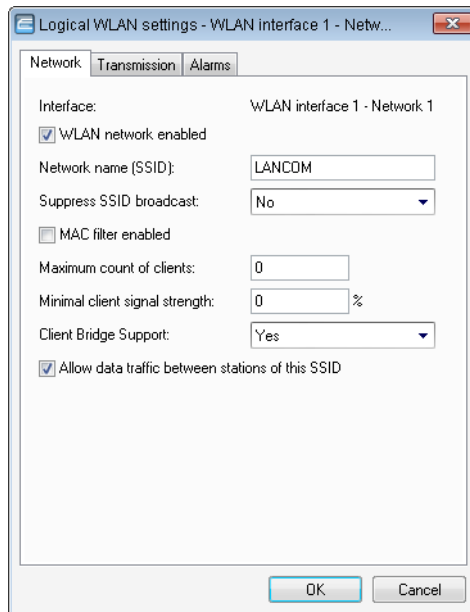

- **WLAN network enabled**

This switch enables or disables the corresponding logical WLAN.

- **Network name (SSID)**

Specify a unique SSID (the network name) for each of the required logical wireless LANs. Only network cards that have the same SSID can register with this wireless network.

- **Suppress SSID broadcast**

You can operate your wireless LAN either in public or private mode. A wireless LAN in public mode can be contacted by any mobile station in the area. Your wireless LAN is put into private mode by activating the closed network function. In this operation mode, mobile stations that do not know the network name (SSID) are excluded from taking part in the wireless LAN.

With the closed-network mode activated, WLAN clients that use an empty SSID or the SSID "ANY" are prevented from associating with your network.

The option **Suppress SSID broadcast** provides the following settings:

- **No:** The access point broadcasts the radio cell's SSID. When a client sends a probe request with an empty or incorrect SSID, the access point responds with the SSID of the radio cell (public WLAN).
- **Yes:** The access point does not broadcast the radio cell's SSID. When a client sends a probe request with an empty SSID, the access point similarly responds with an empty SSID.
- **Tightened:** The access point does not broadcast the radio cell's SSID. When a client sends a probe request with an empty or incorrect SSID, the access point does not respond.

 Simply suppressing the SSID broadcast does not provide adequate protection: When legitimate WLAN clients associate with the access point, this transmits the SSID in plain text so that it is briefly visible to all clients in the WLAN network.

- **MAC filter enabled**

The MAC addresses of the clients that are allowed to associate with an access point are stored in the MAC filter list (**Wireless LAN > Stations > Stations**). The **MAC filter enabled** switch allows you to switch off the use of the MAC filter list for individual logical networks.

 Use of the MAC filter list is required for logical networks in which the clients register via LEPS with an individual passphrase. The passphrase used by LEPS is also entered into the MAC filter list. The access point always consults the MAC filter list for registrations with an individual passphrase, even if this option is deactivated here.

- **Maximum number of clients**

Here you set the maximum number of clients that may associate with this access point. Additional clients wanting to associate will be rejected by the access point.

- **Minimum client signal strength**

This value sets the threshold value in percent for the minimum signal strength for clients when logging on. If the client's signal strength is below this value, the access point stops sending probe responses and discards the client's requests.

A client with poor signal strength will not detect the access point and cannot associate with it. This ensures that the client has an optimized list of available access points, as those offering only a weak connection at the client's current position are not listed.

- **Client-bridge support**

Enable this option for an access point if you have enabled the client-bridge support for a client station in WLAN client mode.

 The client-bridge mode operates between two LANCOM devices only.

- **Allow traffic between stations of this SSID**

Check this option if all stations logged on to this SSID are to be able to communicate with one another.

## Additions to the menu system

### 2.23.20.1.16 Min-Client-Strength

This value defines the minimum signal strength of WLAN clients which the access point will accept, even if a matching SSID or a wildcard SSID is provided. The access point will silently discard all probe requests below this threshold.

You can use this option to prevent large numbers of potential WLAN clients, e.g. mobile handsets, to decrease the WLAN performance with probe requests looking for available WLAN networks.

The strength threshold is specified in percent, which can be translated into an SNR: a threshold of 100 percent means a minimum SNR of 64 dBm, 50 percent means 32 dBm and so on.

**Path Telnet:** /Setup/Interfaces/WLAN/Network

**Possible values:**

- 0% to 100%

**Default:** 0

**Special values:** '0' deactivates the minimum signal strength, the access point will answer all requests.

**Closed-network function: Suppress SSID broadcast**

A WLAN client can only connect to a wireless network if it is informed of the corresponding SSID. The factory settings for many wireless networks allow the use of a blank SSID or the SSID "any", and continuing to use this means that potential intruders do not need to know the wireless LAN's SSID. The closed network function prevents unauthorized WLAN clients from logging into the WLAN. The access point rejects any attempt to log on with a blank SSID or the SSID "any". Any user wanting to logon to the WLAN must know the correct SSID.

 Simply suppressing the SSID broadcast does not provide adequate protection: When legitimate WLAN clients associate with the access point, this transmits the SSID in plain text so that it is briefly visible to all clients in the WLAN network.

**LANconfig:Wireless LAN > General > Interfaces > Logical WLAN settings > Network.**

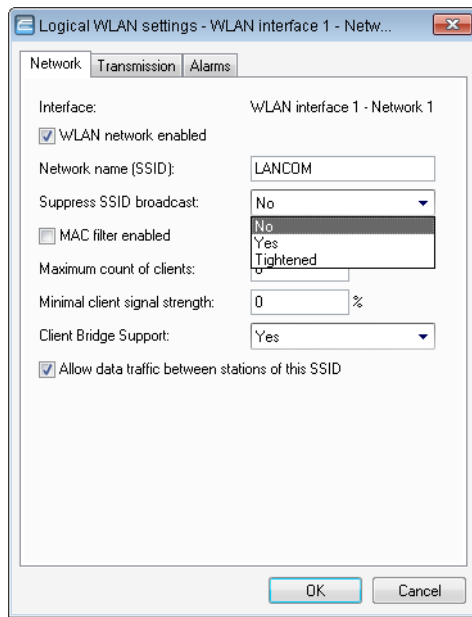

**LANconfig:WLAN Controller > Profiles > Logical WLAN networks (SSIDs)**

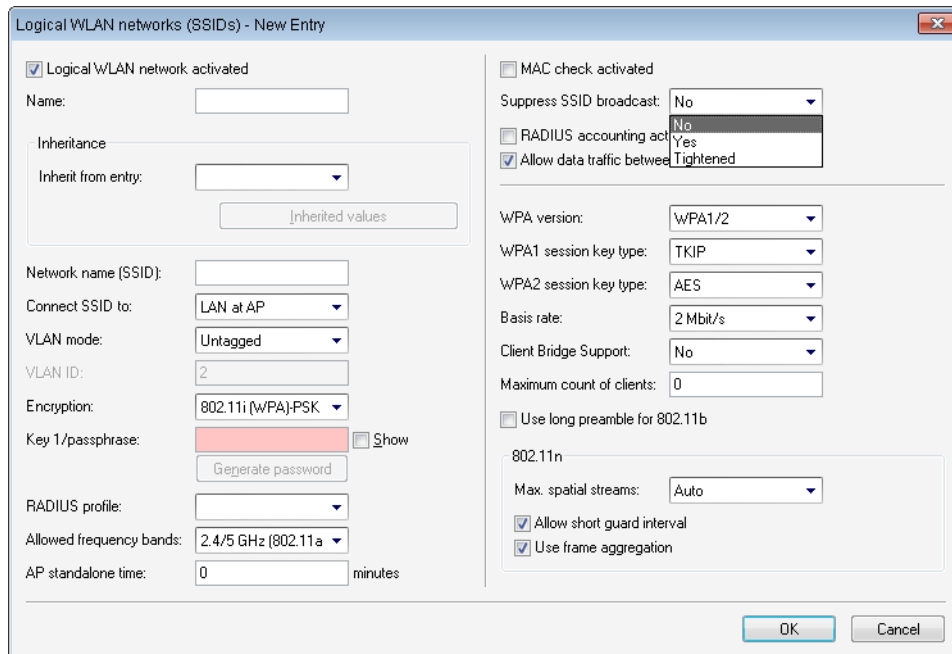



The option **Suppress SSID broadcast** provides the following settings:

- **No:** The access point broadcasts the radio cell's SSID. When a client sends a probe request with a blank or incorrect SSID, the device responds with the SSID of the radio cell (publicly visible WLAN).
- **Yes:** The access point does not broadcast the radio cell's SSID. When a client sends a probe request with an empty SSID, the device similarly responds with an empty SSID. The client cannot log on to the radio cell.
- **Tightened:** The access point does not broadcast the radio cell's SSID. When a client sends a probe request with a blank or incorrect SSID, the device does not respond. The client cannot log on to the radio cell. This setting also reduces the network load if there is a large number of WLAN clients in the radio cell.

### Additions to the menu system

#### Closed network (for standalone access points only)

You can operate your wireless LAN either in public or private mode. A wireless LAN in public mode can be contacted by any mobile station in the area. Your wireless LAN is put into private mode by activating the closed network function. In this operation mode, mobile stations that do not know the network name (SSID) are excluded from taking part in the wireless LAN.

With the closed-network mode activated, WLAN clients that use an empty SSID or the SSID "ANY" are prevented from associating with your network.

The option **Suppress SSID broadcast** provides the following settings:

- **No:** The access point broadcasts the radio cell's SSID. When a client sends a probe request with an empty or incorrect SSID, the access point responds with the SSID of the radio cell (public WLAN).
- **Yes:** The access point does not broadcast the radio cell's SSID. When a client sends a probe request with an empty SSID, the access point similarly responds with an empty SSID.
- **Tightened:** The access point does not broadcast the radio cell's SSID. When a client sends a probe request with an empty or incorrect SSID, the access point does not respond.

 Simply suppressing the SSID broadcast does not provide adequate protection: When legitimate WLAN clients associate with the access point, this transmits the SSID in plain text so that it is briefly visible to all clients in the WLAN network.

#### SNMP ID:

2.23.20.1.4

#### Telnet path:

Telnet path: Setup > Interfaces > WLAN > Network

#### Possible values:

No

Yes

Tightened

#### Default:

No

#### SSID broadcast (for WLAN controllers only)

You can operate your wireless LAN either in public or private mode. A wireless LAN in public mode can be contacted by any mobile station in the area. Your wireless LAN is put into private mode by activating the closed network function. In this operation mode, mobile stations that do not know the network name (SSID) are excluded from taking part in the wireless LAN.

With the closed-network mode activated on the access point, WLAN clients that use an empty SSID or the SSID "ANY" are prevented from associating with your network.

The option **SSID broadcast** provides the following settings:

- **Yes:** The access point broadcasts the radio cell's SSID. When a client sends a probe request with an empty or incorrect SSID, the access point responds with the SSID of the radio cell (publicly visible WLAN).
- **No:** The access point does not broadcast the radio cell's SSID. When a client sends a probe request with an empty SSID, the access point similarly responds with an empty SSID.
- **Tightened:** The access point does not broadcast the radio cell's SSID. When a client sends a probe request with an empty or incorrect SSID, the access point does not respond.

! Simply suppressing the SSID broadcast does not provide adequate protection: When legitimate WLAN clients associate with the access point, this transmits the SSID in plain text so that it is briefly visible to all clients in the WLAN network.

! The "closed network" function for the access point is to be found under **Setup > Interfaces > WLAN > Network**. Please note: If the WLAN controller has the option **SSID broadcast** set to "No" (device does not broadcast the SSID), the access point sets its **closed network** option to "Yes", and vice versa. Only with the setting "Tightened" do both devices retain identical settings.

**SNMP ID:**

2.37.1.1.19

**Telnet path:**

**Telnet path:** Setup > WLAN-Management > AP-Configuration > Networkprofiles

**Possible values:**

No

Yes

Tightened

**Default:**

Yes

## 13.5.8 IEEE 802.1x/EAP

The international industry standard IEEE 802.1x and the **Extensible Authentication Protocol (EAP)** enable access points to carry out reliable and secure access checks. The access information can be managed centrally on a RADIUS server and can be called up by the access point on demand.

This technology also enables the secure transmission and the regular automatic changing of WEP keys. In this way, IEEE 802.1x improves the security of WPA2.

The IEEE-802.1x technology has already been fully integrated since Windows XP. Client software exists for other operating systems.

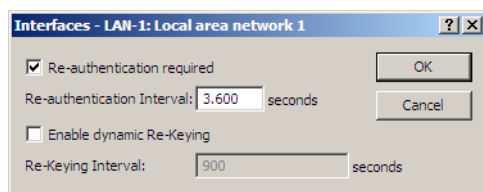

LANconfig: Wireless LAN / General / 802.1X

WEBconfig: LCOS menu tree / Setup / IEEE802.1x

- Regularly update authentication

Here you activate regular re-authentication. If a new authentication starts, the user remains registered during the negotiation. A typical value as a re-authentication interval is 3,600 seconds.

- Re-authentication interval  
The interval for regular re-authentication.
- Activate dynamic re-keying and key transmission  
Here you activate the regular generation and transmission of a dynamic WEP key.
- Re-keying interval  
Interval for the regular generation of the key.

## 13.5.9 Expert WLAN settings

### The beaconing table

Settings in the beaconing table influence the transmission of beacons by the access point in AP mode. In part this can influence the roaming behavior of clients, and in part this serves to optimize the MultiSSID mode for older WLAN clients.

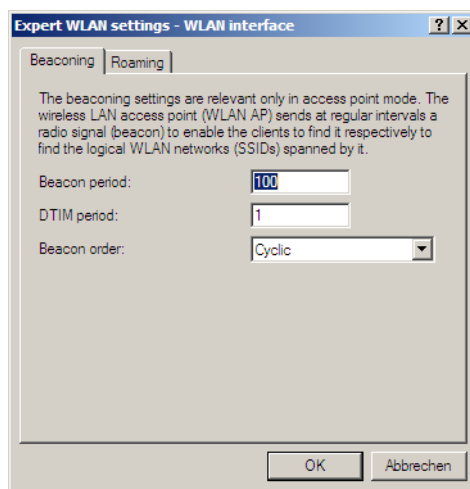

LANconfig: Wireless LAN / Expert WLAN settings / Beaconing

WEBconfig: LCOS menu tree / Setup / Interfaces / WLAN / Beaconing

- Beacon period  
This value defines the time interval in  $\mu\text{s}$  between beacon transmission (1  $\mu\text{s}$  corresponds to 1024 microseconds and is a measurement unit of the 802.11 standard. 1  $\mu\text{s}$  is also known as a Timer Unit (TU)). Smaller values result in a shorter beacon timeout period for the client and enable quicker roaming in case of failure of an access point, but they also increase the WLAN overhead.
- DTIM period  
This value defines the number of beacons which are collected before multicasts are broadcast. Higher values enable longer client sleep intervals, but worsen the latency times.
- Beacon order  
Beacon order refers to the order in which beacons are sent to the various WLAN networks. For example, if three logical WLAN networks are active and the beacon period is 100  $\mu\text{s}$ , then the beacons will be sent to the three WLANs every 100  $\mu\text{s}$ . Depending on the beacon order, the beacons are transmitted at times as follows:
  - Cyclic: In this mode the access point transmits the first beacon transmission at 0  $\mu\text{s}$  to WLAN-1, followed by WLAN-2 and WLAN-3. For the second beacon transmission (100  $\mu\text{s}$ ) WLAN-2 is the first recipient, followed by WLAN-3 and then WLAN-1. For the third beacon transmission (200  $\mu\text{s}$ ) the order is WLAN-3, WLAN-1, WLAN-2. Thereafter the order starts at the beginning again.

- Staggered: In this mode, the beacons are not sent together at a particular time, rather they are divided across the available beacon periods. Beginning at 0 Kµs, WLAN-1 only is sent; after 33.3 Kµs WLAN-2, after 66.6 Kµs WLAN-3. At the start of a new beacon period, transmission starts again with WLAN-1.
- Simple burst: In this mode the access point always transmits the beacons for the WLAN networks in the same order. The first beacon transmission (0 Kµs) is WLAN-1, WLAN-2 and WLAN-3; the second transmission is in the same order, and so on.
- Default: Cyclic

Some older WLANs are unable to process the quick succession of beacons which occur with simple burst. Consequently these clients often recognize the first beacons only and can only associate with this network.

Staggered transmission of beacons produces better results but increases load on the access point's processor. Cyclic transmission proves to be a good compromise as all networks are transmitted first in turn.

## The roaming table

The roaming table contains various threshold values which influence the precise control over the LANCOM Wireless Router's behavior when roaming in the 'Client' operating mode.

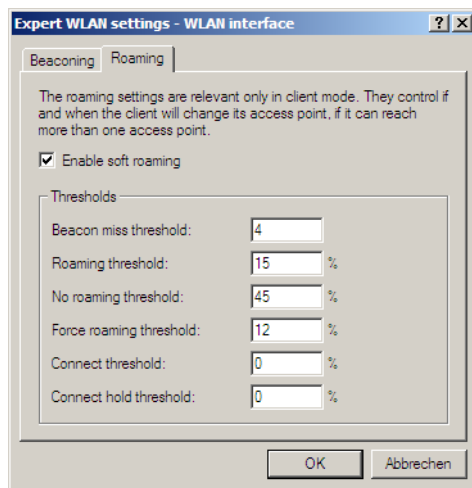

LANconfig: Wireless LAN / Expert WLAN settings / Roaming

WEBconfig: LCOS menu tree / Setup / Interfaces / WLAN / Roaming

- Soft roaming

This option enables a client to use scan information to roam to the strongest access point (soft roaming). Roaming due to connection loss (hard roaming) is unaffected by this. The roaming threshold values only take effect when soft roaming is activated.

- Beacon miss threshold

This defines how many access-point beacons can be missed before an associated client starts searching again.

Higher values will delay the recognition of an interrupted connection, so a longer time period will pass before the connection is re-established.

The smaller the value set here, the sooner a potential interruption to the connection will be recognized; the client can start searching for an alternative access point sooner.

---

! Values which are too small may cause the client to detect lost connections more often than necessary.

- Roaming threshold

This value is the percentage difference in signal strength between access points above which the client will switch to the stronger access point.

! Other contexts require the value of signal strengths in dB. The following conversion applies: 64dB - 100%  
32dB - 50% 0dB - 0%

- No roaming threshold

This threshold refers to the field strength in percent. Field strengths exceeding the value set here are considered to be so good that no switching to another access point will take place.

- Forced roaming threshold

This threshold refers to the field strength in percent. Field strengths below the value set here are considered to be so poor that a switch to another access point is required.

- Connect threshold

This value defines field strength in percent defining the minimum that an access point has to show for a client to attempt to associate with it.

- Connect hold threshold

This threshold defines field strength in percent. A connection to an access point with field strength below this value is considered as lost.

### 13.5.10 WLAN routing (isolated mode)

The standard setting allows data traffic to be "bridged" between LAN and WLAN, i.e. layer-2 transparent transmission. Data traffic between the cabled network and the wireless LAN is **not** directed via the IP router. Consequently, the firewall and Quality of Service functions integrated into the firewall are not available for traffic between LAN and WLAN. In order to be able to use these functions, the WLAN interfaces are set to "isolated mode" and the data traffic is intentionally routed via the IP router.

! To ensure that the IP router can correctly transmit the data between the LAN and WLAN, the two areas must have different IP address ranges. Further information is available in the Advanced Routing and Forwarding (ARF) area.

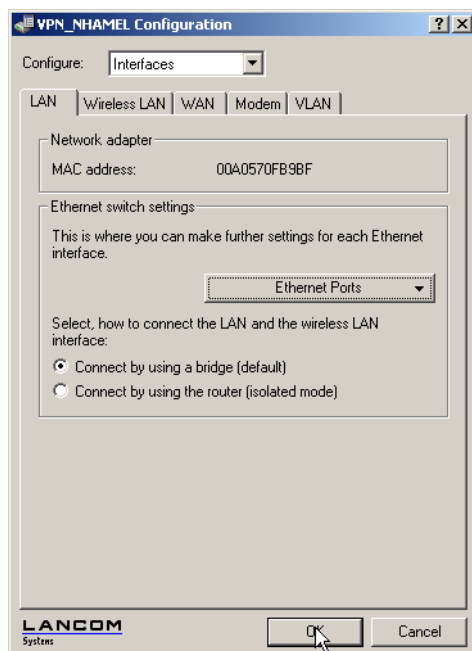

LANconfig: Interfaces / LAN

WEBconfig: LCOS menu tree / Setup / LAN bridge / Isolated mode

### 13.5.11 Addition(s) to LCOS 8.80

#### Closed-network function: Suppress SSID broadcast

A WLAN client can only connect to a wireless network if it is informed of the corresponding SSID. The factory settings for many wireless networks allow the use of a blank SSID or the SSID "any", and continuing to use this means that potential intruders do not need to know the wireless LAN's SSID. The closed network function prevents unauthorized WLAN clients from logging into the WLAN. The access point rejects any attempt to log on with a blank SSID or the SSID "any". Any user wanting to logon to the WLAN must know the correct SSID.

! Simply suppressing the SSID broadcast does not provide adequate protection: When legitimate WLAN clients associate with the access point, this transmits the SSID in plain text so that it is briefly visible to all clients in the WLAN network.

LANconfig:Wireless LAN > General > Interfaces > Logical WLAN settings > Network.

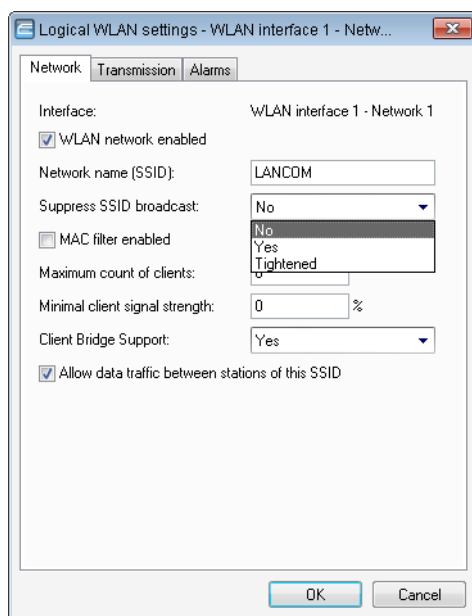

## LANconfig:WLAN Controller > Profiles > Logical WLAN networks (SSIDs)

The option **Suppress SSID broadcast** provides the following settings:

- **No:** The access point broadcasts the radio cell's SSID. When a client sends a probe request with a blank or incorrect SSID, the device responds with the SSID of the radio cell (publicly visible WLAN).
- **Yes:** The access point does not broadcast the radio cell's SSID. When a client sends a probe request with an empty SSID, the device similarly responds with an empty SSID. The client cannot log on to the radio cell.
- **Tightened:** The access point does not broadcast the radio cell's SSID. When a client sends a probe request with a blank or incorrect SSID, the device does not respond. The client cannot log on to the radio cell. This setting also reduces the network load if there is a large number of WLAN clients in the radio cell.

### Additions to the menu system

#### Closed network (for standalone access points only)

You can operate your wireless LAN either in public or private mode. A wireless LAN in public mode can be contacted by any mobile station in the area. Your wireless LAN is put into private mode by activating the closed network function. In this operation mode, mobile stations that do not know the network name (SSID) are excluded from taking part in the wireless LAN.

With the closed-network mode activated, WLAN clients that use an empty SSID or the SSID "ANY" are prevented from associating with your network.

The option **Suppress SSID broadcast** provides the following settings:

- **No:** The access point broadcasts the radio cell's SSID. When a client sends a probe request with an empty or incorrect SSID, the access point responds with the SSID of the radio cell (public WLAN).
- **Yes:** The access point does not broadcast the radio cell's SSID. When a client sends a probe request with an empty SSID, the device similarly responds with an empty SSID.
- **Tightened:** The access point does not broadcast the radio cell's SSID. When a client sends a probe request with a blank or incorrect SSID, the device does not respond.

! Simply suppressing the SSID broadcast does not provide adequate protection: When legitimate WLAN clients associate with the access point, this transmits the SSID in plain text so that it is briefly visible to all clients in the WLAN network.

**SNMP ID:**

2.23.20.1.4

**Telnet path:****Telnet path: Setup > Interfaces > WLAN > Network****Possible values:**

No

Yes

Tightened

**Default:**

No

**SSID broadcast (for WLAN controllers only)**

You can operate your wireless LAN either in public or private mode. A wireless LAN in public mode can be contacted by any mobile station in the area. Your wireless LAN is put into private mode by activating the closed network function. In this operation mode, mobile stations that do not know the network name (SSID) are excluded from taking part in the wireless LAN.

With the closed-network mode activated on the access point, WLAN clients that use an empty SSID or the SSID "ANY" are prevented from associating with your network.

The option **SSID broadcast** provides the following settings:

- **Yes:** The access point broadcasts the radio cell's SSID. When a client sends a probe request with an empty or incorrect SSID, the access point responds with the SSID of the radio cell (publicly visible WLAN).
- **No:** The access point does not broadcast the radio cell's SSID. When a client sends a probe request with an empty SSID, the device similarly responds with an empty SSID.
- **Tightened:** The access point does not broadcast the radio cell's SSID. When a client sends a probe request with a blank or incorrect SSID, the device does not respond.



Simply suppressing the SSID broadcast does not provide adequate protection: When legitimate WLAN clients associate with the access point, this transmits the SSID in plain text so that it is briefly visible to all clients in the WLAN network.



The "closed network" function for the access point is to be found under **Setup > Interfaces > WLAN > Network**. Please note: If the WLAN controller has the option **SSID broadcast** set to "No" (device does not broadcast the SSID), the access point sets its **closed network** option to "Yes", and vice versa. Only with the setting "Tightened" do both devices retain identical settings.

**SNMP ID:**

2.37.1.1.19

**Telnet path:****Telnet path: Setup > WLAN-Management > AP-Configuration > Networkprofiles****Possible values:**

No

Yes

Tightened

**Default:**

Yes



## Enhancements to LANconfig

### Network settings

#### LANconfig:Wireless LAN > General > Logical WLAN settings > Network

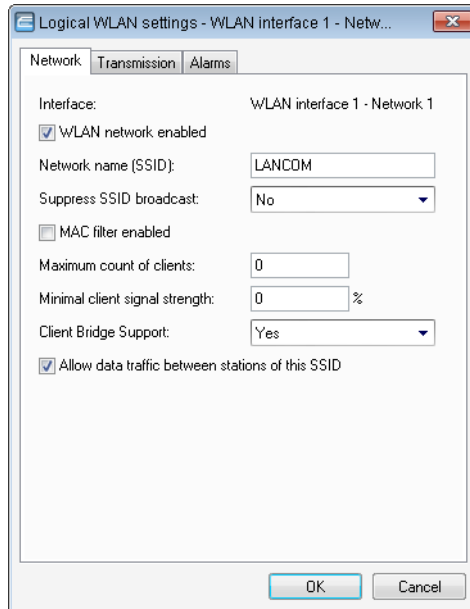

- **WLAN network enabled**

This switch enables or disables the corresponding logical WLAN.

- **Network name (SSID)**

Specify a unique SSID (the network name) for each of the required logical wireless LANs. Only network cards that have the same SSID can register with this wireless network.

- **Suppress SSID broadcast**

You can operate your wireless LAN either in public or private mode. A wireless LAN in public mode can be contacted by any mobile station in the area. Your wireless LAN is put into private mode by activating the closed network function. In this operation mode, mobile stations that do not know the network name (SSID) are excluded from taking part in the wireless LAN.

With the closed-network mode activated, WLAN clients that use an empty SSID or the SSID "ANY" are prevented from associating with your network.

The option **Suppress SSID broadcast** provides the following settings:

- **No:** The access point broadcasts the radio cell's SSID. When a client sends a probe request with an empty or incorrect SSID, the access point responds with the SSID of the radio cell (public WLAN).
- **Yes:** The access point does not broadcast the radio cell's SSID. When a client sends a probe request with an empty SSID, the device similarly responds with an empty SSID.
- **Tightened:** The access point does not broadcast the radio cell's SSID. When a client sends a probe request with a blank or incorrect SSID, the device does not respond.



Simply suppressing the SSID broadcast does not provide adequate protection: When legitimate WLAN clients associate with the access point, this transmits the SSID in plain text so that it is briefly visible to all clients in the WLAN network.

- **MAC filter enabled**

The MAC addresses of the clients that are allowed to associate with an access point are stored in the MAC filter list (**Wireless LAN > Stations > Stations**). The **MAC filter enabled** switch allows you to switch off the use of the MAC filter list for individual logical networks.

 Use of the MAC filter list is required for logical networks in which the clients register via LEPS with an individual passphrase. The passphrase used by LEPS is also entered into the MAC filter list. The access point always consults the MAC filter list for registrations with an individual passphrase, even if this option is deactivated here.

- **Maximum number of clients**

Here you set the maximum number of clients that may associate with this access point. Additional clients wanting to associate will be rejected by the access point.

- **Minimum client signal strength**

This value sets the threshold value in percent for the minimum signal strength for clients when logging on. If the client's signal strength is below this value, the access point stops sending probe responses and discards the client's requests.

A client with poor signal strength will not detect the access point and cannot associate with it. This ensures that the client has an optimized list of available access points, as those offering only a weak connection at the client's current position are not listed.

- **Client-bridge support**

Enable this option for an access point if you have enabled the client-bridge support for a client station in WLAN client mode ().

 The client-bridge mode operates between two LANCOM devices only.

- **Allow traffic between stations of this SSID**

Check this option if all stations logged on to this SSID are to be able to communicate with one another.

## New parameter for WLAN client signal strength

LCOS version 8.62 now optionally evaluates the signal strengths of wireless LAN clients when they logon.

### Additions to the menu system

#### Minimum client strength

This value sets the threshold value in percent for the minimum signal strength for clients when logging on. If the client's signal strength is below this value, the access point stops sending probe responses and discards the client's requests.

A client with poor signal strength will not detect the access point and cannot associate with it. This ensures that the client has an optimized list of available access points, as those offering only a weak connection at the client's current position are not listed.

**SNMP ID:**

2.23.20.1.16

**Telnet path:**

**Telnet path:**Setup > Interfaces > WLAN > Network

**Possible values:**

0-100

**Default:**

0

## 13.6 Configuring the client mode

To connect individual devices with an Ethernet interface into a wireless LAN, LANCOM devices with a WLAN module can be switched to "client mode", whereupon they act as conventional wireless LAN adapters and not as access points (AP). The use of client mode therefore allows devices fitted with only an Ethernet interface, such as PCs and printers, to be integrated into a wireless LAN.

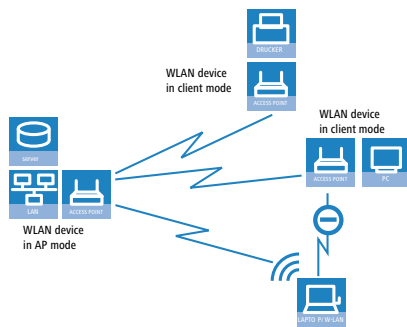

! Multiple WLAN clients can register with a WLAN device in AP mode, which is not the case for a WLAN device in client mode.

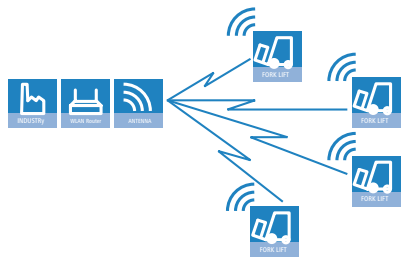

### 13.6.1 Client settings

For LANCOM Access Points and LANCOM Wireless Routers in client mode, further settings/client behavior can be configured from the 'Client mode' tab under the settings for the physical interfaces.

 The configuration of the client settings can also be carried out with the WLAN Wizards in LANconfig.

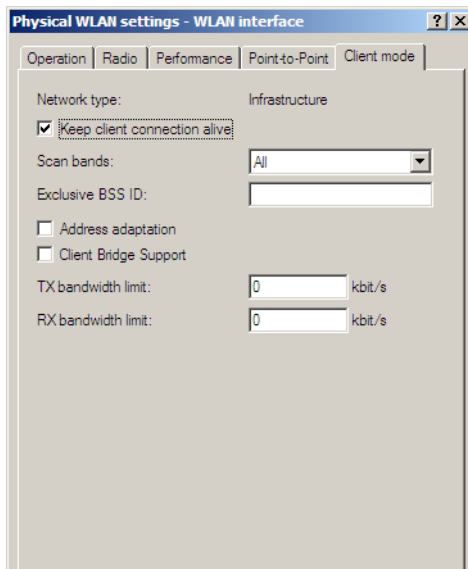

1. To edit the settings for client mode in LANconfig, go to the 'Client mode' tab under the physical WLAN settings for the desired WLAN interface.
2. In 'Scan bands', define whether the client station scans just the 2.4 GHz, just the 5 GHz, or all of the available bands to locate an access point.

### 13.6.2 Set the SSID of the available networks

In the WLAN clients, the SSIDs of the networks to which the client stations are to connect must be entered.

1. To enter the SSIDs, change to the 'General' tab under LANconfig in the 'Wireless LAN' configuration area. In the 'Interfaces' section, select the **first** WLAN interface from the list of logical WLAN settings.

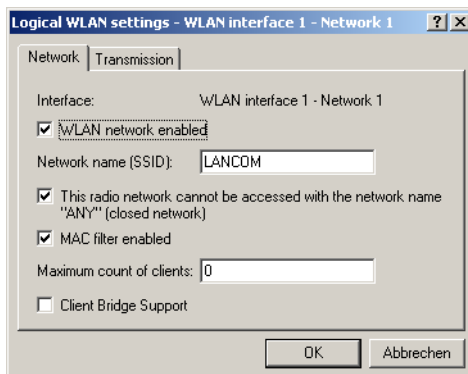

1. Enable the WLAN network and enter the SSID of the network the client station should log onto.

### 13.6.3 Encryption settings

For access to a WLAN, the appropriate encryption methods and key must be set in the client station.

1. To enter the key, change to the '802.11i/WEP' tab under LANconfig in the 'Wireless LAN' configuration area. From 'WPA / private WEP settings', select the **first** WLAN interface from the list of logical WLAN settings.

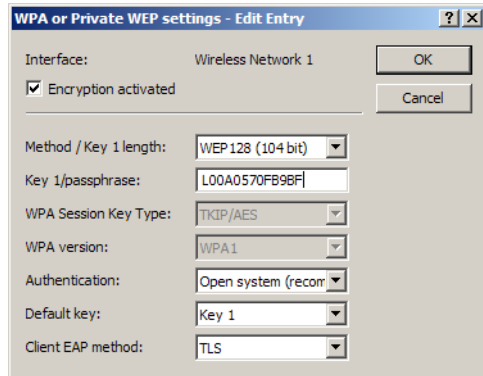

1. Enable encryption and match the encryption method to the settings for the access point.
2. In WLAN client operating mode, the LANCOM Access Points and LANCOM Wireless Routers can authenticate themselves to another access point using EAP/802.1X. For this, select the desired client EAP method here. Note that the selected client EAP method must match the settings of the access point that the device is attempting to log onto.



Depending on the EAP method, the appropriate certificates must be stored in the device:

3. For TTLS and PEAP – the EAP/TLS root certificate only; the key is entered as a combination username:password.
  - For TLS in addition; the EAP/TLS device certificate including the private key.



When working with WPA or 802.1X, settings may need to be made in the RADIUS server.

### 13.6.4 Roaming

Roaming is defined as the transfer of a WLAN client to another access point once the connection to the access point used so far can no longer be kept alive. To allow roaming, at least one additional access point must be within range of the client, it must provide a network with an identical SSID and matching radio and encryption settings.

Under normal circumstances the WLAN client would only log onto another access point if the connection to the access point used up to that point was lost completely (hard roaming). Soft roaming on the other hand enables the client to use scan information to roam to the strongest access point. With the background scanning function, the LANCOM Wireless Router in client mode can gather information on other available access points prior to the connection being lost. In this case the client is not switched to another access point once the existing connection has been lost completely, but rather when another access point within its range has a stronger signal.

1. To enable soft roaming in WEBconfig or telnet, change to Setup > Interfaces > WLAN > Roaming and select the physical WLAN interface.
2. Enable soft roaming and, if required, set the other parameters (such as threshold levels and signal level).

- To configure background scanning in LANconfig, go to the 'Radio' tab under the physical WLAN settings for the desired WLAN interface.

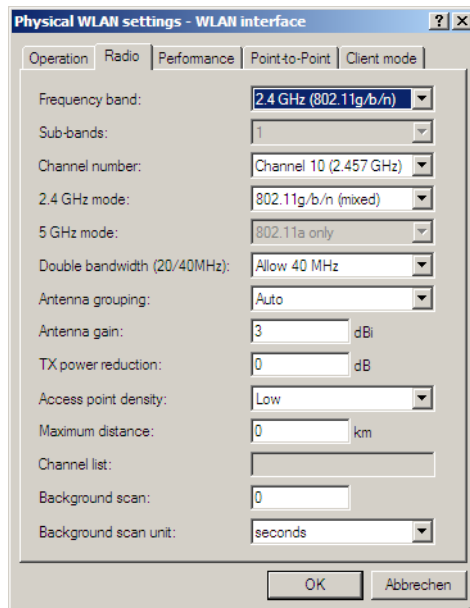

- Enter the background scan interval as the time in which the LANCOM Wireless Router cyclically searches the currently unused frequencies of the active band for available access points. To achieve fast roaming the scan time is set, for example, to 260 seconds (2.4 GHz) or 720 seconds (5 GHz).

## 13.6.5 Addition(s) to LCOS 7.80

### Multiple WLAN profiles in client mode

#### Introduction

If a device equipped with an Ethernet interface is to be connected to a wireless LAN, a LANCOM access point can be switched into client mode, causing it to act as conventional wireless LAN client and not as an access point.

WLAN clients such as notebooks are generally able to save and manage various profiles which allow different access points to be selected depending on the environment (e.g. for a company WLAN or for another WLAN at home). These profiles store various information such as the WLAN SSID and the associated key. The WLAN client automatically selects the profile fitting to the strongest available or preferred WLAN.

LANCOM access points can store up to eight different WLAN profiles for use in client mode. The profile in client mode activates the networking and transmission parameters, and also the encryption settings for the logical WLAN.

⚠ Please observe that a WLAN module in client mode only connects to one access point at a time, even if multiple WLAN profiles have been defined.

## Configuration

Not only can networking, transmission and encryption parameters be defined separately for each WLAN module, but also which criteria are to be used to select the client profile.

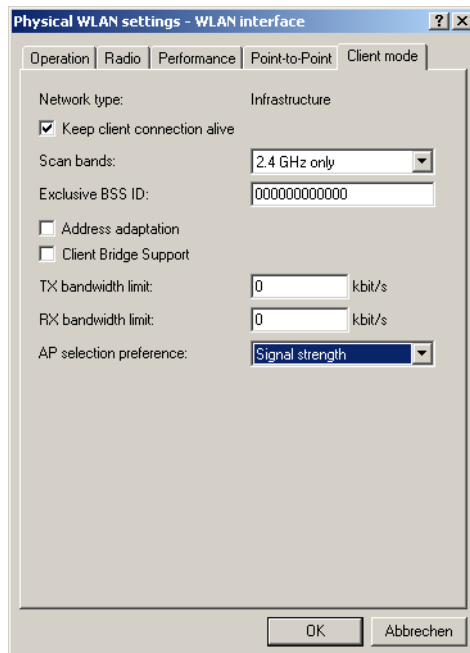

LANconfig: Wireless LAN / General / Physical WLAN settings / Client mode

WEBconfig: LCOS menu tree / Setup / Interfaces / WLAN / Client modes / WLAN-1

- AP selection preference

Here you select how this interface is to be used.

Possible values:

- Signal strength: Selects the profile for the WLAN offering the strongest signal. This setting causes the WLAN module in client mode to automatically switch to a different WLAN as soon as it offers a stronger signal.
- Profile: Selects the profile for available WLANs in the order that they have been defined (WLAN index, e.g. WLAN-1, WLAN-2, etc.), even if another WLAN offers a stronger signal. In this setting, the WLAN module in client mode automatically switches to a different WLAN as soon as a WLAN with a lower WLAN index is detected (irrespective of signal strengths).

Default:

- Signal strength.

## 13.7 Configuring point-to-point connections

LANCOM Access Points can serve not only as central stations in a wireless network, they can also operate in point-to-point mode to bridge longer distances. For example, they can provide a secure connection between two networks that are several kilometers apart — without direct cabling or expensive leased lines.

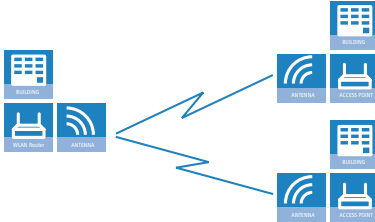

When using Access Points and appropriately polarized antennas in accordance with IEEE 802.11n two wireless links can be established simultaneously between the end points of a point-to-point connection. This allows higher data throughput to be achieved or greater distances to be covered than when using other standards.



Depending on the WLAN standard and WLAN antenna being used, the following data-throughput rates can be achieved:

Access Point	antenna	Data throughput	Range
802.11n indoor AP	Directional antenna with 9° beam spread, lightning protection, 10m cable	240Mbps gross	1km
802.11n indoor AP	Directional antenna with 9° beam spread, lightning protection, 10m cable	15Mbps gross	8,9km
802.11n outdoor AP	Directional antenna with 9° beam spread, lightning protection, 2m cable	240Mbps gross	2,1km
802.11n outdoor AP	Directional antenna with 9° beam spread, lightning protection, 2m cable	15Mbps gross	18km
802.11a indoor AP	Directional antenna with 9° beam spread, lightning protection, 10m cable	54Mbps gross	0,4km
802.11a indoor AP	Directional antenna with 9° beam spread, lightning protection, 10m cable	6Mbps gross	6km
802.11a outdoor AP	Directional antenna with 9° beam spread, lightning protection, 2m cable	54Mbps gross	1,3km
802.11a outdoor AP	Directional antenna with 9° beam spread, lightning protection, 2m cable	6Mbps gross	13km
802.11g indoor AP	Directional antenna with 30° beam spread, lightning protection, 10m cable	54Mbps gross	0,08km
802.11g indoor AP	Directional antenna with 30° beam spread, lightning protection, 10m cable	6Mbps gross	1km
802.11g outdoor AP	Directional antenna with 30° beam spread, lightning protection, 2m cable	54Mbps gross	0,28km
802.11g outdoor AP	Directional antenna with 30° beam spread, lightning protection, 2m cable	6Mbps gross	2,5km



Highly optimized wireless bridges based on IEEE 802.11n are capable of high data transfer rates even over long distances. This chapter introduces the basic principles involved in designing point-to-point links and provides tips on aligning the antennas.

### 13.7.1 Geometric dimensioning of outdoor wireless network links

The following basic questions must be answered when designing wireless links:

- Which antennas are necessary for the desired application?
- How do the antennas have to be positioned to ensure problem-free connections?
- What performance characteristics do the antennas need to ensure sufficient data throughput within the legal limits?

#### Selection of antennas using the LANCOM Antenna Calculator

You can use the LANCOM Antenna Calculator to calculate the output power of the access points as well as the achievable distances and data rates. The program can be downloaded from our Web site at [www.lancom.de](http://www.lancom.de).

After selecting your components (access points, antennas, lightning protection and cable) the calculator works out the data rates, ranges, and the antenna gain settings that have to be entered into the access point.

! Please note that when using 5 GHz antennas additional technologies such as dynamic frequency selection (DFS) may be stipulated depending on the country of use. The operator of the wireless LAN system is responsible for ensuring that local regulations are met.

LANCOM Antenna Distance Calculator

Version 1.22 EN

Point A Point B

Access Point/Client Adapter: LANCOM OAP-3109n Wireless

WLAN Chipset: AR9160/AR9106

WLAN Standard: 802.11a/n (5 GHz)

Antenna: AirLancer Extender O-D9a

Cable 1: OAP-Cable 1 1m

Surge Arrestor: Yes

Cable 2: No second Cable

10 dB "bad weather" Reserve: Yes

Gross Data Rate [Mbps] (for P2P radio link)	Max. Distance [km] (for P2P radio link)
15.0	8,913
30.0	8,310
45.0	5,012
60.0	3,548
90.0	2,512
120.0	1,413
135.0	1,259
150.0	0,794
30.0	5,310
60.0	4,467
90.0	3,548
120.0	2,512
180.0	1,778
240.0	1,000
270.0	0,794
300.0	0,562

Distance to Data Rate

Legend: 20 MHz (km/Mbps) 40 MHz (km/Mbps)

Maximum of 100Mbps netto available.

## Positioning the antennas

Antennas do not broadcast their signals linearly, but within an angle that depends on the model in question. The spherical expansion of the signal waves produces amplification or interference of the effective power output at certain distances along the connection between the transmitter and receiver. The areas where the waves amplify or cancel themselves out are known as Fresnel zones.

Protecting the components employed from the consequences of lightning strikes and other electrostatic influences is one of the most important aspects to be considered when designing and installing wireless LAN systems for outdoor use. Please refer to the appropriate notes on 'Lightning and surge protection' as otherwise LANCOM Systems cannot provide any guarantee for damage to LANCOM and AirLancer components.

Information on the installation of WLAN systems for outdoor deployment is available in the 'LANCOM Outdoor Wireless Guide'.

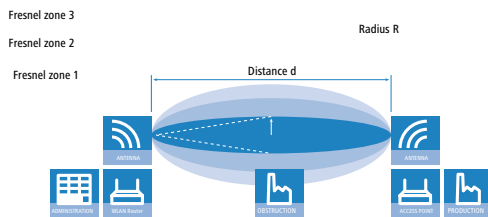

The Fresnel zone 1 must remain free from obstruction in order to ensure that the maximum level of output from the transmitting antenna reaches the receiving antenna. Any obstructing element protruding into this zone will significantly impair the effective signal power. The object not only screens off a portion of the Fresnel zone, but the resulting reflections also lead to a significant reduction in signal reception.

The radius (R) of Fresnel zone 1 is calculated with the following formula assuming that the signal wavelength ( $\lambda$ ) and the distance between transmitter and receiver (d) are known.

$$R = 0.5 * \sqrt{(\lambda * d)}$$

The wavelength in the 2.4 GHz band is approx. 0.125 m, in the 5 GHz band approx. 0.05 m.

**Example:** With a separating distance of 4 km between the two antennae, the radius of Fresnel zone 1 in the 2.4-GHz band is **11 m**, in the 5-GHz band **7 m**.

To ensure that the Fresnel zone 1 remains unobstructed, the height of the antennas must exceed that of the highest obstruction by this radius. The full height of the antenna mast (M) should be as depicted:

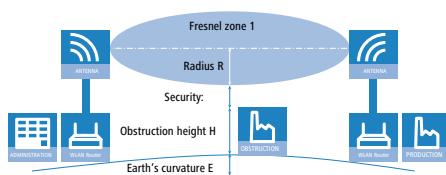

$$M = R + m + H + E \text{ (earth's curvature)}$$

The allowance for the curvature of the earth (E) can be calculated at a distance (d) as  $E = d^2 * 0.0147$  – i.e. at a distance of 8 km this is almost 1m

**Example:** With a distance of 8 km between the antennae, the result in the 2.4-GHz band is a mast height above the level of the highest obstruction of approx. **13 m**, in the 5-GHz band **9 m**.

## Antenna power

The power of the antennas must be high enough to ensure acceptable data transfer rates. On the other hand, the country-specific legal regulations regarding maximum transmission power should not be exceeded.

The calculation of effective power considers everything from the radio module in the transmitting access point to the radio module in the receiving access point. In between there are attenuating elements such as the cable, plug connections or simply the air transmitting the signals and amplifying elements such as the external antennas.

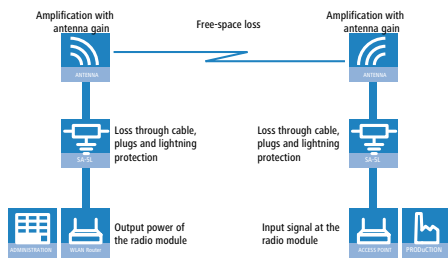

### 13.7.2 Antenna alignment for P2P operations

The precise alignment of the antennas is of considerable importance in establishing P2P connections. The more central the receiving antenna is located in the "ideal line" of the transmitting antenna, the better are the actual performance and the effective bandwidth. If the receiving antenna is outside of this ideal area, however, significant losses in performance will be the result.

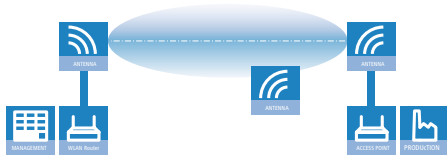

! You can find further information on the geometrical design of wireless paths and the alignment of antennas with the help of LANCOM software in the LCOSreference manual.

The current signal quality over a P2P connection can be displayed on the device's LEDs or in the LANmonitor in order to help find the best possible alignment for the antennas.

The display of signal quality on the LEDs must be activated for the wireless LAN interface (LANconfig: **Wireless LAN / General / Physical WLAN settings / Operation**). The faster the LED blinks the better the connection (a blinking

frequency of 1 Hz represents a signal quality of 10 dB, double the frequency indicates that the signal strength is twice as high).

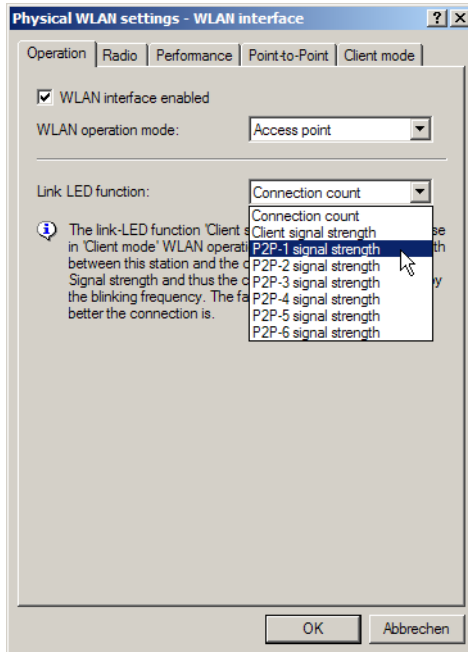

In LANmonitor the connection quality display is opened with the context menu. Right-clicking with the mouse on 'Point-to-point' activates the option 'Adjusting Point-to-Point WLAN Antennas...'

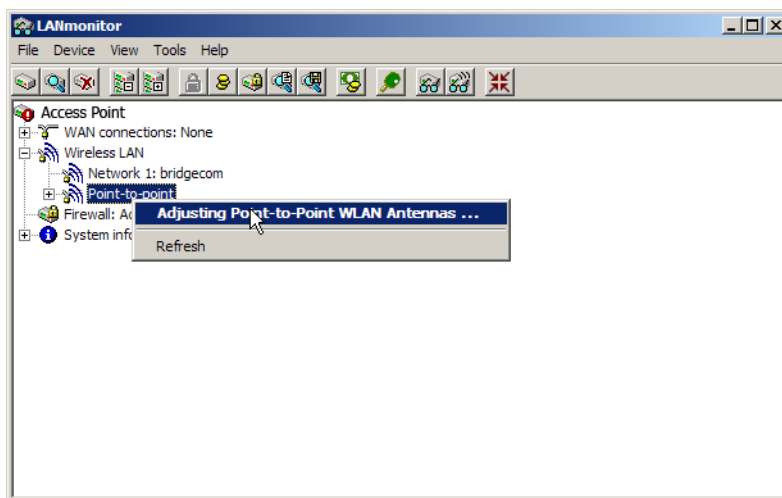

! The 'Point-to-point' entry is only visible in the LANmonitor if the monitored device has at least one base station defined as a remote site for a P2P connection (LANconfig: **Wireless LAN / General / Physical WLAN settings / Point-to-Point**).

In the dialog for setting up point-to-point connections, LANmonitor prompts for the information required to establish the P2P connection:

- Is the P2P connection configured at both ends (remote base station defined with MAC address or station name)?
- Is the point-to-point mode of operation activated?
- Which access point is to be monitored? All of the base stations defined as P2P remote sites in the device concerned can be selected here.
- Are both antennas approximately aligned? The basic P2P connection has to be working before fine-tuning can be performed with the aid of LANmonitor.

Once signal monitoring has commenced, the P2P dialog displays the absolute values for the current signal strength and the maximum value since starting the measurement. The development of the signal strength over time and the maximum value are displayed in a diagram, too.

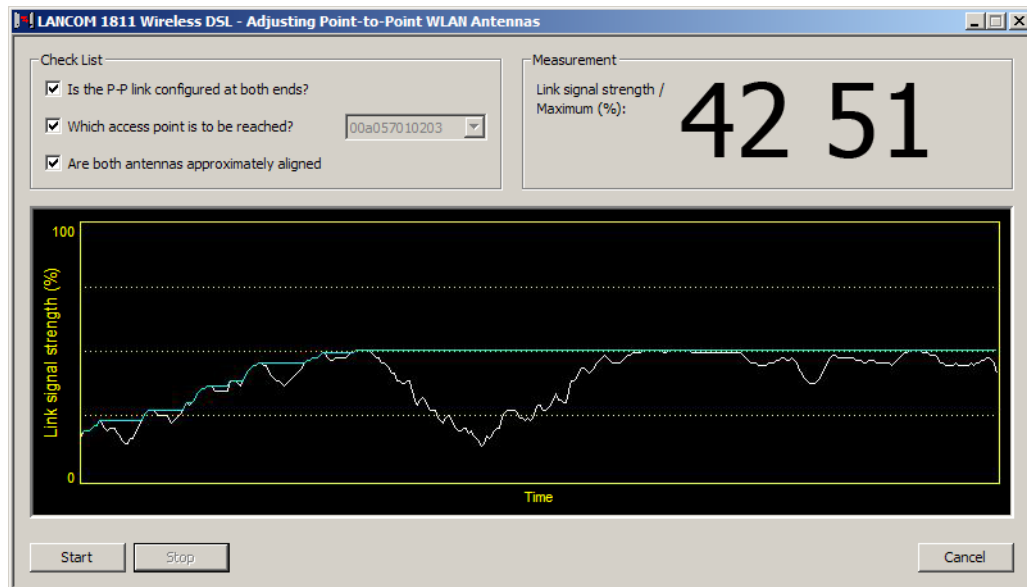

Initially only one of the two antennas should be adjusted until a maximum value is achieved. This first antenna is then fixed and the second antenna is then adjusted to attain the best signal quality.

### 13.7.3 Measuring wireless bridges

After planning and installation, the wireless bridge can be analyzed to determine the actual data throughput. Further information about the available tools and taking measurements can be found in the LANCOM Techpaper "The performance of outdoor P2P connections", available as a download from [www.lancom.de](http://www.lancom.de).

### 13.7.4 Activating point-to-point operation mode

The behavior of an access point when exchanging data with other access points is defined in the "Point-to-point operation mode".

- **Off:** The access point only communicates with mobile clients
- **On:** The access point can communicate with other access points and with mobile clients
- **Exclusive:** The access point only communicates with other base stations

In the 5 -GHz band, the automatic search for vacant WLAN channels can lead to several simultaneous test transmissions from multiple access points, with the result that they do not find each other. This stalemate situation can be avoided with the appropriate "Channel selection scheme":

- **Master:** This access point takes over the leadership when selecting a free WLAN channel.
- **Slave:** All other access points will search for a channel until they have found a transmitting Master.

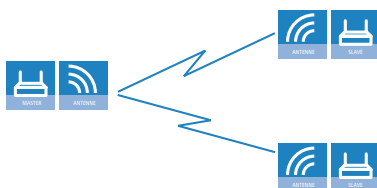

Thus it is recommended for the 5 GHz band that one central access point should be configured as 'Master' and all other point-to-point partners should be configured as 'Slave'. In the 2.4 GHz band, too, this setting simplifies the establishment of point-to-point connections if the automatic channel search is activated.

! It is imperative that the channel selection scheme is configured correctly if the point-to-point connections are to be encrypted with 802.11i/WPA (a master as authentication server and a slave as client).

### 13.7.5 Configuration of P2P connections

In the configuration of point-to-point connections, entries have to be made for the point-to-point operation mode and the channel selection scheme, along with the MAC addresses or station names of the remote sites.

! The configuration of the P2P connections can also be carried out with the WLAN Wizards in LANconfig.

1. Click on the button **Physical WLAN settings** to open the corresponding WLAN interface and select the tab for 'Point-to-Point'.
2. Activate the suitable point-to-point operation mode here and set the channel selection scheme to either 'Master' or 'Slave'. If the peers of the P2P connections are to be identified via their station names, then enter a unique name for this WLAN station.

! For models with multiple WLAN modules, the station name can be entered separately for each physical WLAN interface.

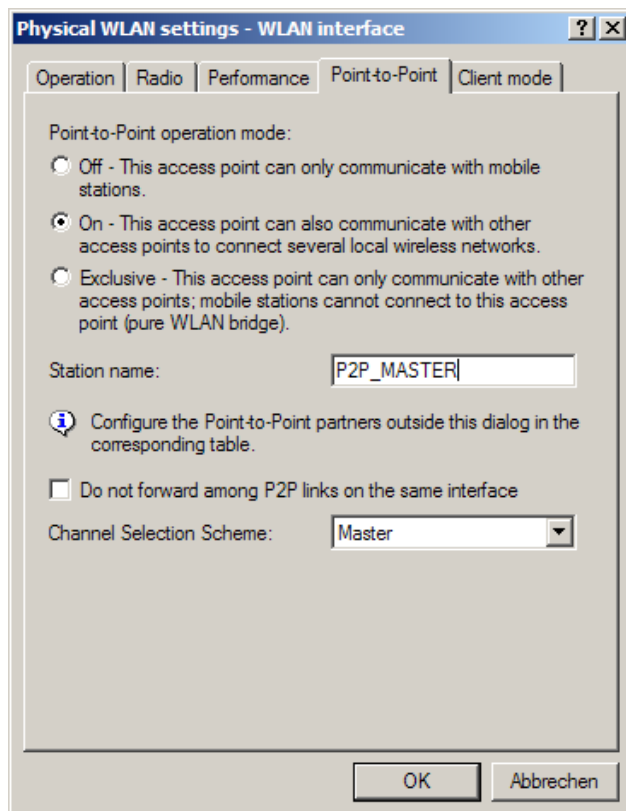

1. Close the physical WLAN settings and open the list of **Point-to-point partners**. For each of the maximum of six P2P connections, enter either the MAC address of the WLAN card at the remote station or enter the WLAN station's name (depending on the chosen method of identification).

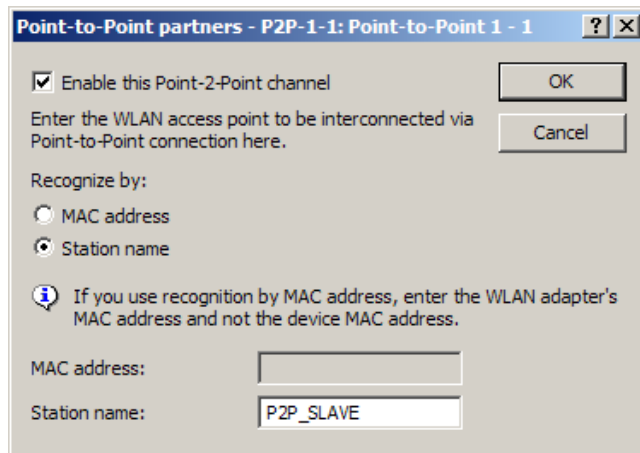

- ⚠ Please observe that only the MAC addresses of the WLAN cards at the other end of the connections are to be entered here! Not the access point's own MAC address, and not the MAC addresses from any other interfaces that may be present in the access points.

You will find the WLAN MAC address on a sticker located under each of the antenna connectors. Only use the string that is marked as the "WLAN MAC" or "MAC-ID". The other addresses that may be found are not the WLAN MAC address but the LAN MAC address.



### Connecting point-to-point remote stations by station name

When configuring point-to-point connections, an alternative to the MAC addresses is to use the station names of the remote stations.

First of all the station name is entered into the point-to-point settings in the Wireless Routers or Access Points.

- LANconfig: **Wireless LAN / General / Physical WLAN settings / Point to point**
- WEBconfig: **Setup / Interfaces / WLAN interpoint settings**

- ! For models with multiple WLAN modules, the station name can be entered separately for each physical WLAN interface.

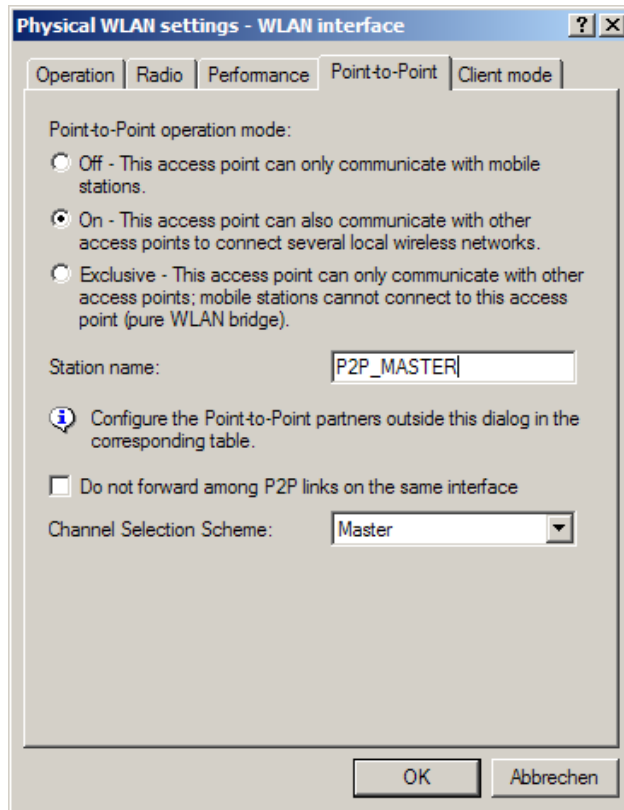

In the point-to-point configuration, select the identification by station name and enter the name of the corresponding station.

- LANconfig: **Wireless LAN / General / Point to point partners**
- WEBconfig: **Setup / Interfaces / WLAN interpoint peers**

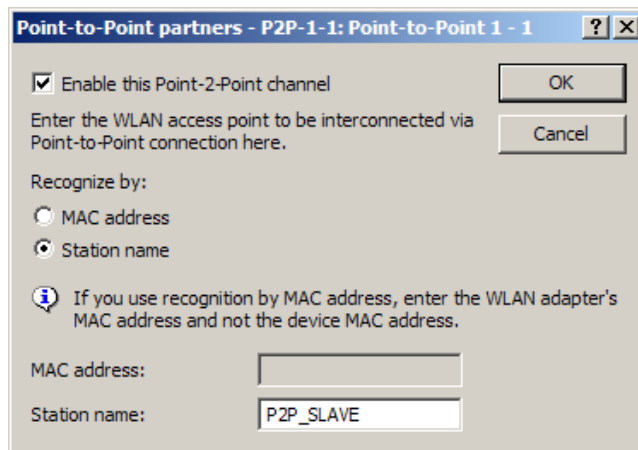



### 13.7.6 Access points in relay mode

Access points equipped with two wireless modules can be used to establish wireless bridges across multiple stations. Each wireless module is configured as a 'Master' and then 'Slave' in turn.

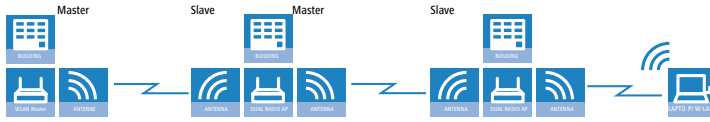

! Employing relay stations with two WLAN modules each also cuts down on the problems from "hidden stations".

### 13.7.7 Security for point-to-point connections

IEEE 802.11i can be used to attain a significant increase in the security of WLAN point-to-point connections. All of the advantages of 802.11i such as the simple configuration and the powerful encryption with AES are thus available for P2P mode, as are the improved security of the passphrase from the LANCOM Enhance Passphrase Security (LEPS).

#### Encryption with 802.11i/WPA

To activate the 802.11i encryption for a correctly configured P2P connection, adjust the settings for the first logical WLAN network in the appropriate WLAN interface (i.e. WLAN-1 if you are using the first WLAN module for the P2P connection, WLAN-2 if you are using the second module, e.g. as with an access point with two WLAN modules).

- Activate the 802.11i encryption.
- Select the method '802.11i (WPA)-PSK'.
- Enter the passphrase to be used.

! The passphrases should consist of a random string at least 32 characters long.

When set as P2P Master, the passphrase entered here will be used to check the Slave's authorization to access. When set as P2P Slave, the access point transfers this information to register with the remote site.

For configuration with LANconfig you will find the encryption settings under the configuration area 'Wireless LAN' on the '802.11i/WEP' tab.

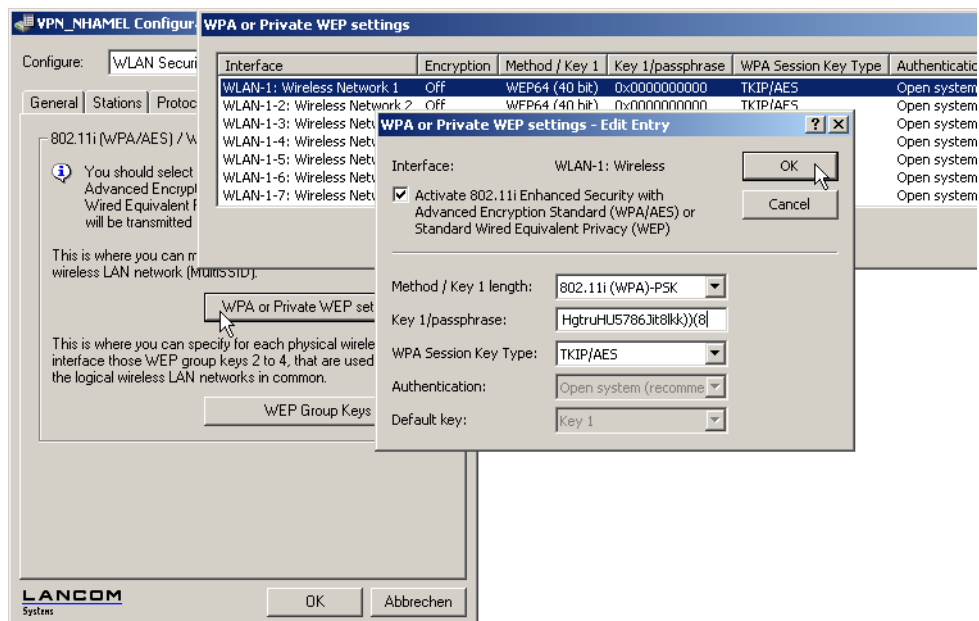

## LEPS for P2P connections

A further gain in security can be attained by additionally using LANCOM Enhanced Passphrase Security (LEPS) which involves the matching of MAC address and passphrase.

LEPS can be used to secure single point-to-point (P2P) connections with an individual passphrase. Even if an access point in a P2P installation is stolen and the passphrase and MAC address become known, all other WLAN connections secured by LEPS remain secure.

When using LANconfig for the configuration, you enter the passphrases of the stations approved for the WLAN in the configuration area 'Wireless LAN' on the 'Stations' tab under the button **Stations**.

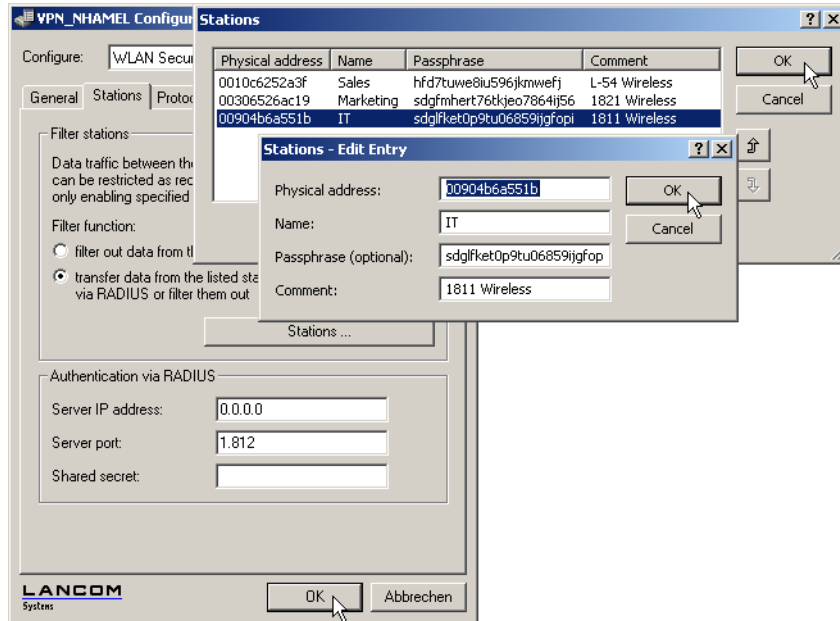

### 13.7.8 Addition(s) to LCOS 8.50

#### Auto-configuration of WLAN P2P links over serial connections

When configuring wireless P2P links, the remote sites usually recognize one another by a particular feature of the P2P partner; either the station name or the MAC address as entered into the access point's configuration.

However, when changing P2P partners, it is not possible to enter a fixed parameter into the configuration. For example, if you want to set up a P2P link between two train carriages to offer IP services on the whole train, the P2P partners could change according to the combination of carriages.

In these cases, the access points can exchange their MAC addresses via the serial interface. To do this, interconnect the devices via two wires of the serial interface. You can then set the P2P peer recognition to the value 'Serial autoconfig'. You then configure the P2P links as if for a fixed installation of the access points.

In the default state, the WLAN modules are disabled. When the devices are turned on, they first exchange their MAC addresses, the WLAN modules are activated and the P2P link is established automatically.

#### Additions to the menu system

##### Serial configuration

This menu contains the settings for the auto configuration of WLAN point-to-point links over a serial connection.

**Telnet path:** /Setup/COM-Ports

**English description:** WAN

**Telnet path, English:** LCOS Menu Tree/Setup/COM-Ports

### Bit rate

This item sets the bit rate for communications between the devices when a serial connection is used for the automatic configuration of WLAN point-to-point links.

**Telnet path:** /Setup/COM-Ports

**English description:** WAN

**Telnet path, English:** LCOS Menu Tree/Setup/COM-Ports

### Possible values:

- 1200
- 2400
- 4800
- 9600
- 19200
- 38400
- 57600
- 115200

**Default:** 9600



It is imperative that the same bit rate is set in all devices communicating over serial connections to be used for the automatic configuration of WLAN point-to-point links.

## 13.7.9 Addition(s) to LCOS 8.60

### Point-to-point partners

Up to 16 point-to-point connections can be activated for each WLAN module. In LANconfig you find these settings under **Wireless LAN > General > Interfaces > Point-to-point partners**

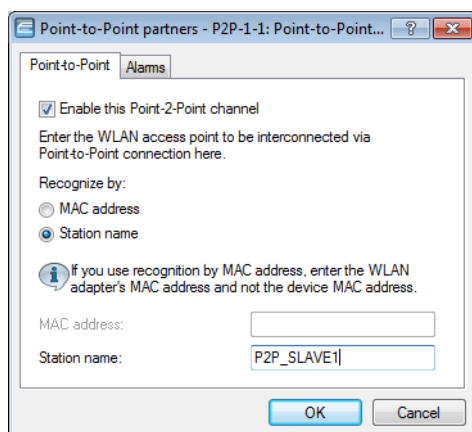

Proceed as follows to set up a point-to-point link:

1. Select the option **Enable this point-2-point channel**.
2. Select whether the P2P peer is to be identified by its **MAC address** or its **Station name**.
3. The corresponding text box is activated. Enter the MAC address or station name.

! If you work with detection by MAC address, enter the MAC address of the WLAN module here and not that of the device itself.

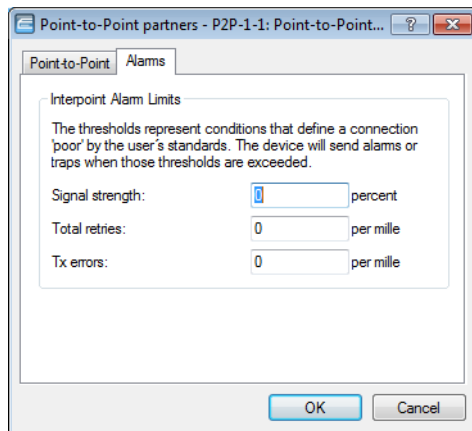

On the **Alarm** tab, you can set threshold values for **signal strength**, **total repetitions** and **Tx errors** for the point-to-point connection. If the value exceeds or falls below this value, the access point sets off alarms or traps.

Conclude your entries by clicking on **OK**.

### Additions to the menu system

#### Interpoint peers

Here you enter the wireless base stations that are to be networked via the point-to-point connection.

**SNMP ID:** 223.20.12

**Telnet path:** /Setup/Interfaces/WLAN

## 13.8 Centralized WLAN Management

LANCOM WLAN controllers and LANCOM routers with WLC option provide a centrally controlled WLAN management for larger-scale WLAN infrastructures. The WLAN controller centrally stores the configurations of individual access points as profiles and distributes these to the appropriate devices.

! This documentation will use "WLAN Controller" as a generic term for LANCOM WLAN controllers and LANCOM routers with WLC option.

### 13.8.1 Starting position

The widespread use of wireless access points and wireless routers provides great convenience and flexibility in network access for businesses, universities and other organizations.

Yet in spite of the numerous advantages WLAN infrastructures offer, there are still a number of unsettled issues:

- All wireless access points must be configured and require appropriate monitoring in order to recognize unwelcome WLAN clients, etc. The administration of the access points, especially for larger WLAN infrastructures with the appropriate security mechanisms, requires advanced qualifications and experience on the part of those responsible, and it ties up considerable resources in the IT departments.
- The manual customization of the configurations in the access points when changes are made to the WLAN infrastructure can be time-consuming, with the result that different configurations can be present in the WLAN at the same time.

- Combined utilization of the shared communications medium (air) requires effective coordination of the access points to avoid frequency interference and optimize network performance.
- In public places, access points are a potential security risk because the devices themselves, including the security-related data in them such as passwords, etc., are susceptible to theft. In addition, rogue access points may be able to connect to the LAN unnoticed, bypassing the security policies that are in place.

## 13.8.2 Technical concepts

Centralized WLAN management is the solution to these problems. The configuration of the access points is then no longer carried out in the devices themselves but by a central authority instead, the WLAN controller. The WLAN controller authenticates the access points and transmits the correct configuration to the approved devices. This allows for convenient configuration of the WLAN from a central point and the changes to the configuration affect all of the access points simultaneously. Optionally the configuration provided by the WLAN controller is **not** stored in the access point's flash memory but in RAM, so security-related data cannot fall into the hands of unauthorized persons in the event of theft of a device. Only in "standalone" operation is the configuration optionally saved for a defined period to flash memory (in an area that cannot be read out with LANconfig or other tools).

### The CAPWAP standard

The CAPWAP protocol (Control And Provisioning of Wireless Access Points) introduced by the IETF (Internet Engineering Task Force) is a draft standard for the centralized management of large WLAN infrastructures.

CAPWAP uses two channels for data transfer:

- Control channel, encrypted with Datagram Transport Layer Security (DTLS). This channel is used to exchange administration information between the WLAN controller and the access point.



DTLS is an encryption protocol based on TLS but, in contrast to TLS itself, it can be used for transfers over connectionless, unsecured transport protocols such as UDP. DTLS therefore combines the advantages of the high security provided by TLS with the fast transfer via UDP. This also makes DTLS suitable for the transfer of VoIP packets (unlike TLS) because, even after the loss of a packet, the subsequent packets can be authenticated again.

- Data channel, optionally also encrypted with DTLS. The payload data from the WLAN is transferred through this channel from the access point via the WLAN controller into the LAN—encapsulated in the CAPWAP protocol.

### Smart controller technology

In a decentralized WLAN structure with stand-alone access points (operating as so-called "rich access points") all functions for data transfer take place in the PHY layer, the control functions in the MAC layer, and the management functions are integrated in the access points. Centralized WLAN management divides these tasks among two different devices:

- The central WLAN controller assumes the administration tasks.
- The decentralized access points handle the data transfer at the PHY layer and the MAC functions.
- A RADIUS or EAP server can be added as a third component RADIUS or for authentication of WLAN clients (which can also be the case in stand-alone WLANs).

CAPWAP describes three different scenarios for the relocation of WLAN functions to the central WLAN controller.

- Remote MAC: In this case, all of the WLAN functions are transferred from the access point to the WLAN controller. Here, the access points only serve as "extended antennas" without independent intelligence.

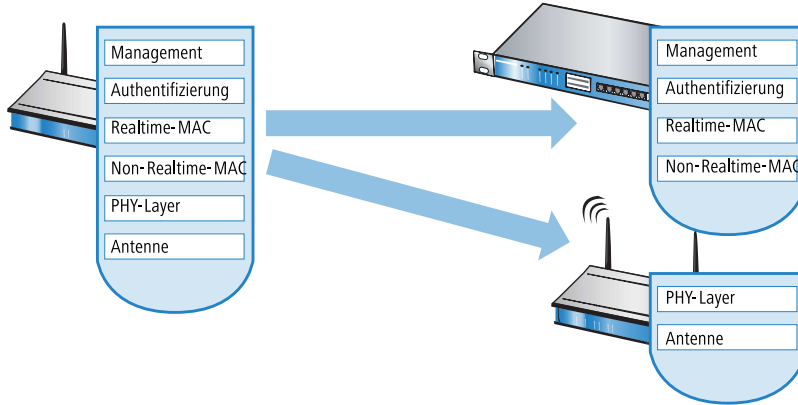

- Split MAC: With this variant, only a portion of the WLAN functions are transferred to the WLAN controller. Normally, real-time applications will continue to be processed in the access point; the non-real-time applications are processed via the central WLAN controller.

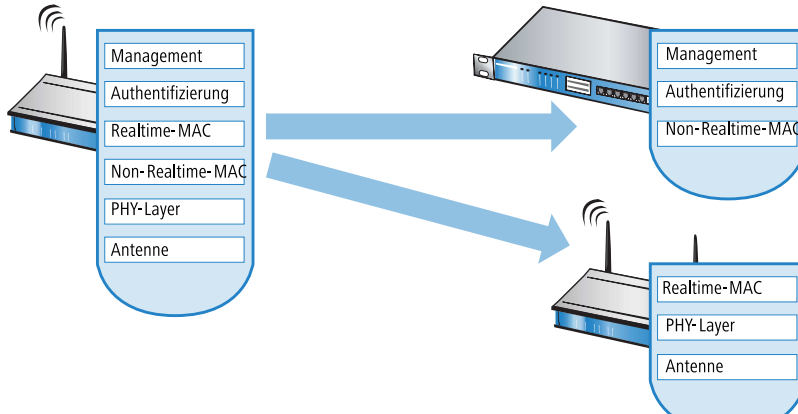

- Local MAC: The third possibility provides for complete management and monitoring of the WLAN data traffic directly in the access points. The only information exchanged between the access point and the WLAN controller is for network management and ensures that the access points have a uniform configuration.

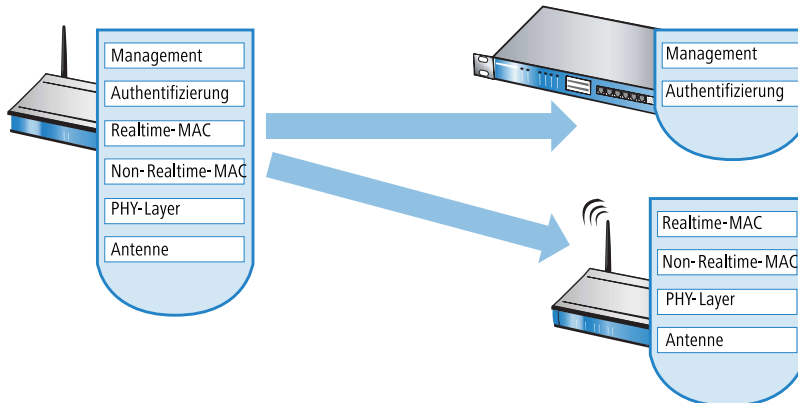

The technology from LANCOM Systems uses the local MAC procedure. Thanks to the reduction of centralized tasks, these WLAN infrastructures offer optimum scalability. At the same time, infrastructure of this type prevents the WLAN controller from becoming a central bottleneck that has to process large portions of the overall data traffic. In remote MAC and split MAC architectures, **all** payload data is forced to run centrally via the WLAN controller. In local MAC architectures

the data can alternatively be broken out from the access points directly to the LAN to provide high-performance data transfer. WLAN controllers from LANCOM are also suitable for WLANs that work with the draft IEEE 802.11n standard, so offering much higher bandwidths than previous WLAN technologies. With break-out into the LAN, data can also be directly routed into special VLANs. This makes it very easy to set up closed networks, such as for guest access accounts.

### **Layer-3 tunneling and layer-3 roaming**

LANCOM WLAN controllers also support the transfer of payload data through a CAPWAP tunnel.

- This allows selected applications such as VoIP to be routed via the central WLAN controller, for example. If WLAN clients change to a different radio cell, the underlying IP connection will not be interrupted because it continues to be managed by the central WLAN controller (layer-3 roaming). In this way, mobile SIP telephones can easily roam between Ethernet subnets, even during a call.
- Managing data streams centrally can also make configuring VLANs at the switch ports unnecessary in environments with numerous VLANs because all CAPWAP tunnels are centrally managed on the WLAN controller.

## **Communication between access point and WLAN controller**

 As of firmware version LCOS 7.20 there is a difference between LANCOM access points (e. g. the LANCOM L-54ag) and LANCOM wireless routers (e.g. the LANCOM 1811 Wireless) with regard to the ex-factory default settings in the WLAN modules. In the following specifications, the general term access point will be used for the most part.

Communication between an access point and the WLAN controller is always initiated by the access point. In the following cases, the devices search for a WLAN controller that can assign a configuration to them:

- When shipped, the WLAN modules in LANCOM access points are set to the 'Managed' operating mode. In this mode, LANCOM access points search for a central WLAN controller that can provide them with a configuration, and they remain in "search mode" until they discover a suitable WLAN controller or until the operating mode of the WLAN module is changed manually.
- While searching for a WLAN controller, LANCOM access points switch off their WLAN module(s).
- Ex-factory, the WLAN modules in LANCOM wireless routers are set to the 'access point' operating mode. In this mode, LANCOM wireless routers function as standalone access points with a configuration that is stored locally in the device. For integration into a WLAN infrastructure that is centrally managed by WLAN controllers, the operating mode of the WLAN modules in LANCOM wireless routers has to be switched into the 'managed' mode.

The access point sends a "discovery request message" at the beginning of communication to find the available WLAN controllers. This request is sent as a broadcast. However, because in some structures a potential WLAN controller cannot be reached by a broadcast, special addresses from additional WLAN controllers can also be entered into the configuration of the access points.

 The DNS names of WLAN controllers can also be resolved. All access points with LCOS 7.22 or higher have the default name 'WLC-Address' pre-configured so that a DNS server can resolve this name to a LANCOM WLAN controller. The same applies to the DHCP suffixes learned via DHCP. This also makes it possible to reach WLAN controllers that are not located in the same network, without having to configure the access points.

From the available WLAN controllers, the access point selects the best one and requests it to establish the DTLS connection. The "best" WLAN controller for the access point is the one with the least load, i.e. the lowest ratio of managed access points compared to the maximum possible number of access points. In case of two or more equally "good" WLAN controllers, the access point selects the nearest one in the network, i.e. that with the fastest response time.

The WLAN controller then uses an internal random number to determine a unique and secure session key, which it uses to secure the connection to the access point. The CA in the WLAN controller issues a certificate to the access point by means of SCEP. The certificate is protected by a one-time-only "challenge" (password). The access point uses this certificate for authentication at the WLAN controller to collect the certificate.

The access point is provided with the configuration for the integrated SCEP client via the secure DTLS connection – the access point uses the SCEP to retrieve its certificate from the SCEP CA. Once this is done, the assigned configuration is transferred to the access point.

! SCEP stands for Simple Certificate Encryption Protocol, CA for Certification Authority.

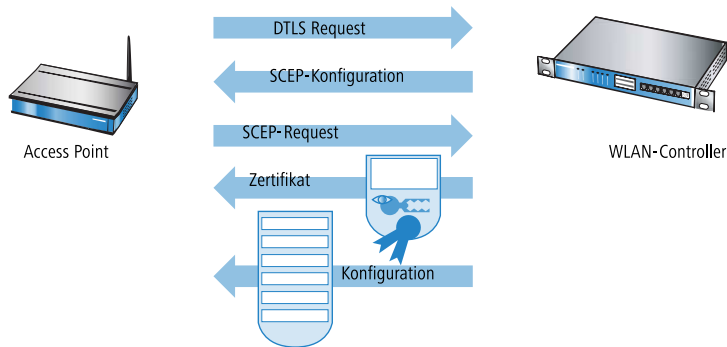

Authentication and configuration can both be carried out either automatically or only with a corresponding entry of the access point's MAC address in the AP table of the WLAN controller. If the access point's WLAN modules were deactivated at the beginning of the DTLS communication, these will be activated after successful transfer of the certificate and configuration (provided they are not explicitly deactivated in the configuration).

The management and configuration data will then be transferred via the CAPWAP tunnel. The payload data from the WLAN client is then released in the access point directly into the LAN and transferred, for example, to the server.

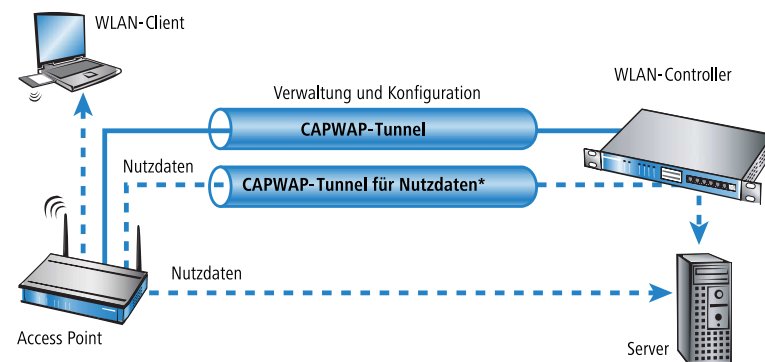

## Zero-touch management

With their ability to automatically assign a certificate and configurations to the requesting access points, LANCOM WLAN controllers implement true "zero-touch management". Simply connect new access points to the LAN—no further configuration is necessary. This simplification to only having to install devices reduces the workload for IT departments, especially in decentralized structures, because no special IT or WLAN expertise is required for the setup at the remote locations.

## Split management

LANCOM access points can search for their WLAN controller in remote networks—a simple IP connection, such as via a VPN path, is all you need. As the WLAN controllers only influence the WLAN part of the configuration in the access point, all of the other functions can be managed separately. This division of the configuration tasks makes LANCOM WLAN controllers perfect for establishing a company-wide WLAN infrastructure that is based at the headquarters and includes all of the branch and home offices connected to it.



## 13.8.3 Configuration

### Configuring the access points

As of firmware version LCOS 7.20 there is a difference between LANCOM access points (e. g. the LANCOM L-54ag) and LANCOM wireless routers (e.g. the LANCOM 1811 Wireless) with regard to the ex-factory default settings in the WLAN modules.

- When shipped, the WLAN modules in LANCOM access points are set to the 'Managed' operating mode. In this mode, LANCOM access points search for a central WLAN controller that can provide them with a configuration, and they remain in "search mode" until they discover a suitable WLAN controller or until the operating mode of the WLAN module is changed manually.
- Ex-factory, the WLAN modules in LANCOM wireless routers are set to the 'access point' operating mode. In this mode, LANCOM wireless routers function as standalone access points with a configuration that is stored locally in the device. For integration into a WLAN infrastructure that is centrally managed by WLAN controllers, the operating mode of the WLAN modules in LANCOM wireless routers has to be switched into the 'managed' mode.

! The operating mode can be set separately for every WLAN module. For models with two WLAN modules, one module can work with a local configuration and the second module can be centrally managed with a WLAN controller.

For individual devices, the operating mode of the WLAN modules can be found in LANconfig under **Wireless LAN > General > Physical WLAN settings > Operation mode**:

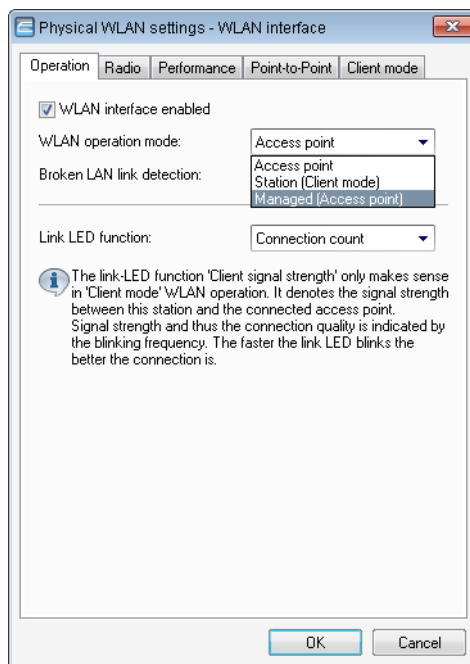

If you need to change the operating mode for multiple devices, you can use a simple script on the devices with the following lines:

```
Script
lang English
flash 0
cd Setup/Interfaces/WLAN/Operational
set WLAN-1 0 managed-AP 0
done
exit
```

## Configuring the WLAN Controller

Most of the parameters for configuring the LANCOM WLAN controller correspond with those of the access points. For this reason, this section does not explicitly describe all of the WLAN parameters, but only those aspects necessary for operating the WLAN controller.

### General settings

This area is for the basic settings of your WLAN controller.

- Automatically accept new APs (auto-accept)

Enables the WLAN controller to provide all new access points with a configuration, even those not in possession of a valid certificate.

Enables the WLAN controller to provide a certificate to all new access points **without** a valid certificate. One of two conditions must be fulfilled for this:

- A configuration is entered into the AP table for the access point under its MAC address.
- The option 'Automatically provide APs with the default configuration' is activated.

- Automatic provision of the default configuration

This enables the WLAN controller to assign a default configuration to every new access point (i.e. those **without** a valid certificate) even if no explicit configuration has been stored for it. In combination with auto-accept, the LANCOM WLAN controller can accept all managed-mode access points which are found in the WLAN infrastructure managed by it (up to the maximum number of access points that it can handle). Access points that are accepted by default are also entered into the MAC list.



This option can potentially lead to the acceptance of unintended access points into the WLAN infrastructure. For this reason this option should only be activated during the start-up phase when setting up a centrally managed WLAN infrastructure

Combining the settings for auto-accept and default configuration can cater for a variety of different situations for the setup and operation of access points:

Auto-accept	Default configuration	Suitable for
On	On	Rollout phase: Use this combination only if you can be sure that <b>no unintended access points</b> are connected with the LAN and thus accepted into the WLAN infrastructure.
On	Off	Controlled rollout phase: Use this combination if you have entered all of the approved access points into the AP table along with their MAC addresses and that these are to be automatically accepted into the WLAN infrastructure.
Off	Off	Normal operation: No new access points will be accepted into the WLAN infrastructure without the administrator's approval.

### Basic configuration of the WLAN controller function

To get started, a LANCOM WLAN controller requires the following two pieces of information to carry out the mainly automated configuration of the access points:

- Current time information (data and time) for checking the validity of the necessary certificates.
- A WLAN profile that the WLAN controller can assign to the access points.

Further optional examples for configuration include setting up redundant WLAN controllers, the manual disconnection and connection of access points, and backing up any necessary certificates.

### Setting the time information for the LANCOM WLAN controller

The management of access points in a WLAN infrastructure is based upon the automatic distribution of certificates via the Simple Certificate Enrollment Protocol (SCEP).

The LANCOM WLAN controller can only check the temporal validity of these certificates if it is set with the current time.

To set the time in the device start LANconfig, click on the entry for the WLAN controller with the right-hand mouse key and select **Set date/time** from the context menu. Alternatively in WEBconfig you can click on **Extras** and then **Set date and time**.



Alternatively, LANCOM WLAN controllers can automatically retrieve the current time from a time server by means of the Network Time Protocol (NTP). Information on NTP and its configuration can be found in the LCOS reference manual.

For LANCOM WLC-4006 models the time information must be obtained from a time server, as these devices do not have a battery-fed real-time clock.

As soon as the WLAN controller has valid time information it begins with the generation of the certificates (root and device certificate). Once the necessary certificates have been generated, the LANCOM WLAN controller indicates that it is operational and the WLAN LED blinks red.



Once operational, you should make a backup copy of the certificates ([Backing up the certificates](#))

### Creating a default configuration

With the time information and the certificates, the LANCOM WLAN controller is ready for operations. If the LAN contains access points in managed mode (standard mode for ex-factory access points or after being reset with LCOS 7.20 or higher; for the manual setting see [Configuring the access points](#)), the WLAN controller soon displays these as "New access points" in LANmonitor. In addition, the New APs LED of the WLAN Controller will blink orange. In case the device comes with a display, it will show the number of new Access Points (New APs).

To be able to provide these new access points with WLAN settings, the LANCOM WLAN controller must contain at least one default configuration that can be provided to the access points that are searching for one.

### Example of a default configuration

1. Open up the configuration of the WLAN controller by double-clicking on its entry in LANconfig.

2. Activate the options for the automatic acceptance of new access points and the provision of a default configuration under **WLAN controller > General**.

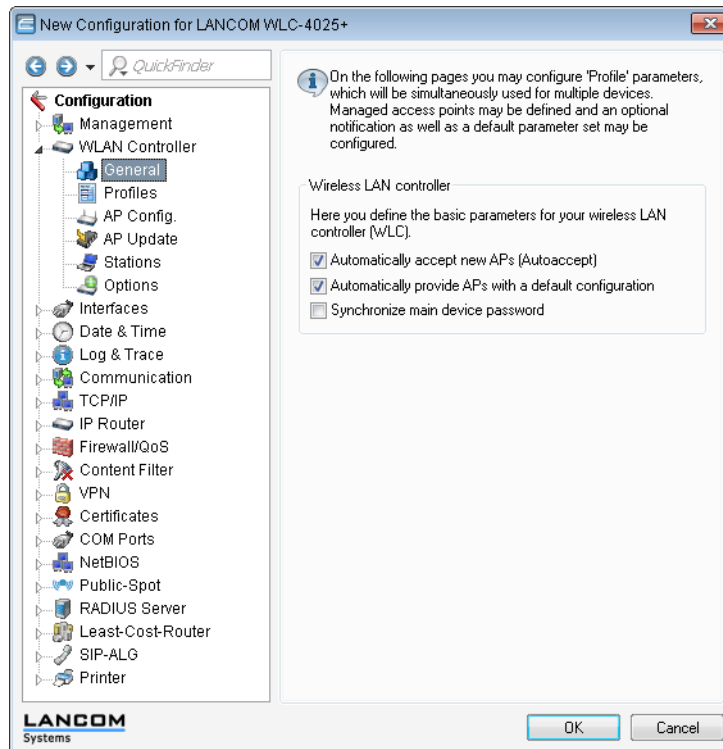

- **Automatically accept new APs (Auto-accept)** Enables the WLAN controller to provide a certificate to all new access points without a valid certificate. To this end, either a configuration for the access point has to be entered into the AP table, or 'Automatically provide APs with a default configuration' has to be activated.
- **Automatically provide APs with a default configuration:** This enables the WLAN controller to assign a default configuration to every new access point, even if no explicit configuration has been stored for it.

By combining these two options, the LANCOM WLAN controller can automatically integrate any managed-mode access point found in the LAN into its WLAN infrastructure. This may, for example, be a temporary measure during the rollout phase of a WLAN installation.

3. On the **Profiles** page, move to the logical WLAN networks. Add a new entry with the following values:

- **Name:** Give the WLAN a name. This name is used only for administrative purposes in the LANCOM WLAN controller.
  - **SSID:** This SSID is used for the WLAN clients to connect.
  - **Encryption:** Select the encryption method suitable for the WLAN clients being used, and enter a key or passphrase, as applicable.
  - Deactivate the MAC check. Instructions on the use of MAC filter lists in managed WLAN infrastructures can be found under [Checking WLAN clients with RADIUS \(MAC filter\)](#).
4. A new entry also has to be added to the physical WLAN parameters. In most cases involving the default configuration, just entering a name is sufficient. Adjust the other settings to meet your needs, if necessary.

- ! For normal access point applications you should use only the 5-GHz subbands 1 and 2. Subband 3 is for special applications only (e.g. BFWA, Broadband Fixed Wireless Access).

Physical WLAN parameters - New Entry

Name: PHY-1

Inheritance  
Inherit from entry: [dropdown]  
[Inherited values]

Country: Default

Auto. channel selection: 1,6,11

2.4 GHz mode: 802.11g/b/n [mixed]

5 GHz mode: 54Mbit/s mode

5 GHz Sub-bands: 1+2

DTIM period: 1

Background scan: 0 seconds

Antenna gain: 3 dBi

TX power reduction: 0 dB

VLAN module of the managed accesspoints activated

Mgmt. VLAN mode: Untagged

Management VLAN-ID: 2

Enable QoS according to 802.11e (WME)

Indoor only mode activated

Report clients activated

5. Create a new WLAN profile, give it an unique name, and assign the above logical WLAN network and physical WLAN parameters to it.

WLAN profiles - New Entry

Profile name: PROFILE-1

Specify in the following list up to 16 logical WLAN networks for this profile.

WLAN network list: LOG-1

Physic. WLAN parameters: PHY-1

List of alternative WLCs: [empty field]

6. Change to the **AP config** view, open the **Access point table** and add a new entry by clicking on the **Default** button. Assign the WLAN profile to it as defined above. Leave **AP name** and **Location** empty.

- ! The **MAC address** is set to 'ffffffffff' for the default configuration and it cannot be edited. This entry is thus a standard for any access point that is not explicitly listed with its MAC address in this table.

### Configuring the access points

As of firmware version LCOS 7.20 there is a difference between LANCOM access points (e. g. the LANCOM L-54ag) and LANCOM wireless routers (e.g. the LANCOM 1811 Wireless) with regard to the ex-factory default settings in the WLAN modules.

- When shipped, the WLAN modules in LANCOM access points are set to the 'Managed' operating mode. In this mode, LANCOM access points search for a central WLAN controller that can provide them with a configuration, and they remain in "search mode" until they discover a suitable WLAN controller or until the operating mode of the WLAN module is changed manually.
- Ex-factory, the WLAN modules in LANCOM wireless routers are set to the 'access point' operating mode. In this mode, LANCOM wireless routers function as standalone access points with a configuration that is stored locally in the device. For integration into a WLAN infrastructure that is centrally managed by WLAN controllers, the operating mode of the WLAN modules in LANCOM wireless routers has to be switched into the 'managed' mode.

- ! The operating mode can be set separately for every WLAN module. For models with two WLAN modules, one module can work with a local configuration and the second module can be centrally managed with a WLAN controller.

For individual devices, the operating mode of the WLAN modules can be found in LANconfig under **Wireless LAN > General > Physical WLAN settings > Operation mode**:

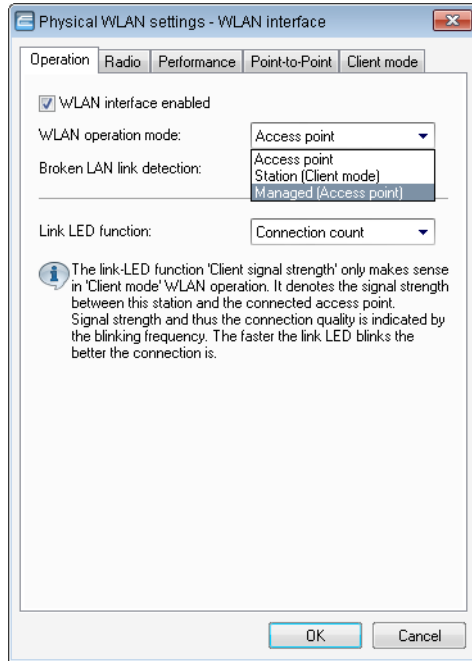

If you need to change the operating mode for multiple devices, you can use a simple script on the devices with the following lines:

```
Script
lang English
flash 0
cd Setup/Interfaces/WLAN/Operational
set WLAN-1 0 managed-AP 0
done
exit
```

## Profiles

The profiles area is used to define the logical WLAN networks, physical WLAN parameters, and the WLAN profiles which combine these two elements.

### WLAN profiles

The WLAN profiles are collections of the various settings that are to be assigned to the access points. The allocation of WLAN profiles to the access points is set in the AP table.

The following parameters can be defined for every WLAN profile:

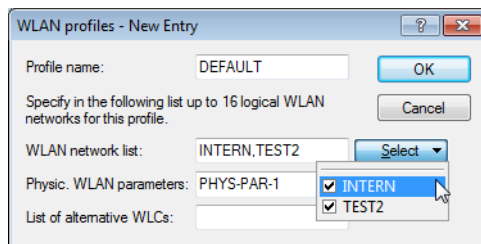

LANconfig: **WLAN Controller > Profiles > WLAN profiles**

WEBconfig: **LCOS Menu Tree > Setup > WLAN-Management > AP-Configuration > Commonprofiles**



- **Profile name**

Name of the profile under which the settings are saved.

- **WLAN network list**

List of the logical WLAN networks that are assigned via this profile.

! From this list, access points use only the first eight entries that are compatible with their own hardware. This means that eight WLAN networks for purely 2.4-GHz operations and eight for purely 5-GHz operations can be defined in a profile. Consequently, each LANCOM access point—be it a model offering 2.4-GHz or 5-GHz support—can choose from a maximum of eight logical WLAN networks.

- **Physical WLAN parameters**

A set of physical parameters to be used by the access point WLAN modules.

- **IP address of alternative WLAN controllers**

A list of WLAN controllers that the access points should attempt to connect with. The access point starts searching for a WLAN controller with a broadcast. Defining alternative WLAN controllers is worthwhile when a broadcast cannot reach all WLAN controllers (e.g. if the WLAN controller is located in another network).

### Logical WLAN networks

Here the logical WLAN networks are set for assignment to the access points. The following parameters can be defined for each logical WLAN network:

LANconfig: **WLAN controller > Profiles > Logical WLAN networks**

WEBconfig: **LCOS Menu Tree > Setup > WLAN-Management > AP-Configuration > Network profiles**

- **Network name**

Name of the logical WLAN network under which the settings are saved. This name is only used for internal administration of logical networks.

- **Inheritance**

Selection of a logical WLAN network defined earlier and from which the settings are to be inherited.

- **SSID**

Service Set Identifier – the name under which the logical WLAN network is offered to the WLAN clients.

■ **VLAN-ID**

VLAN ID for this logical WLAN network

---

 Please note that to use VLAN IDs in a logical WLAN network, you must set up a management VLAN ID.

■ **AP standalone time**

The time in minutes that a managed-mode access point continues to operate in its current configuration.

The configuration is provided to the access point by the WLAN controller and is optionally stored in flash memory (in an area that is not accessible to LANconfig or other tools). Should the connection to the WLAN controller be interrupted, the access point will continue to operate with the configuration stored in flash for the time period entered here. The access point can also continue to work with this flash configuration after a local power outage.

If there is still no connection to the WLAN controller after this time period has expired then the flash configuration is deleted and the access point goes out of operation. As soon as the WLAN controller is available again, the configuration is transmitted again from the WLAN controller to the access point.

This option enables an access point to continue operating even if the connection to the WLAN controller is temporarily interrupted. Furthermore this represents an effective measure against theft as all security-related configuration parameters are automatically deleted after this time has expired.

---

 If the access point establishes a backup connection to a secondary WLAN controller, then the countdown to the expiry of standalone operation is halted. The access point and its WLAN networks remain active as long as it has a connection to a WLAN controller.

---

 Please note that the configuration in flash memory is deleted only after expiry of the time for standalone operation, and not when the power is lost!

---

 All other WLAN network parameters correspond to those for the standard configuration of access points.

## Physical WLAN parameters

Here the physical WLAN parameters are set for assignment to the access points. The following parameters can be defined for each set of physical WLAN parameters:

LANconfig: **WLAN Controller > Profiles > Physical WLAN parameters**

WEBconfig: **LCOS Menu Tree > Setup > WLAN management > AP configuration > Radio profiles**

### ■ Name

Unique name for this combination of physical WLAN parameters.

### ■ Inheritance

Selection of a physical WLAN parameter set defined earlier and from which the settings are to be inherited.

### ■ Country

The country in which the access points are to be operated. This information is used to define country-specific settings such as the permitted channels, etc.

### ■ Automatic channel selection

By default, the access points can use all of the channels permitted in the country of operation. To restrict the selection to certain channels, these can be entered here as a comma-separated list. It is also possible to specify ranges (e.g. '1,6,11').

### ■ Management VLAN ID

The VLAN ID of the management network that is to manage the access points.

! The Management VLAN ID **must** be set to a value not equal to zero in order for VLANs to be used over the WLAN networks. This also applies when the management network itself is not to be tagged with VLAN IDs (Mgmt-VLANID=1).

! VLAN activation only applies to WLAN networks which are connected by means of these physical WLAN parameters.

! All other physical WLAN parameters correspond to those for the standard configuration of access points.

### Inheritance of parameters

A LANCOM WLAN controller is capable of managing a large number of different access points at different locations. However, WLAN profiles include settings that are not equally suitable for every type of access point that can be managed. For example, there are differences between the country settings and the device properties.

In order to avoid having to maintain multiple redundant WLAN profiles to cater for countries or device types, it is possible to "inherit" selected properties from the logical WLAN networks and the physical WLAN parameters.

1. You should initially generate the basic settings that are valid for the majority of the managed access points.
2. You can then start to generate entries for the more specific values, e.g. physical settings for a certain country, or a logical WLAN network for public access by mobile clients.

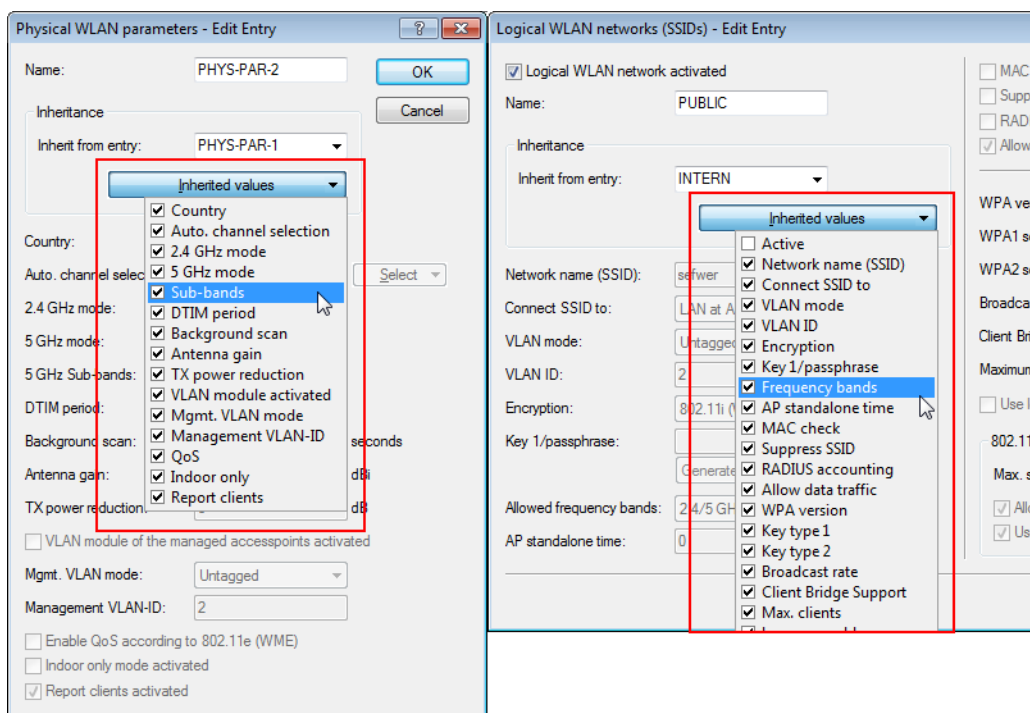

3. Select the entry from which the values are to be inherited and mark the values for inheritance. Parameters inherited in this way are displayed in the configuration dialog in gray and they cannot be edited.
4. Depending on the application, the WLAN settings collected in this way are then grouped into separate profiles, and these are then assigned to their respective access points.

! Inheritance fundamentally allows chains over multiple stages (cascading). This means, for example, that country and device-specific parameters can be grouped for convenience.

Recursion is also possible—profile A inherits from profile B, and at the same time B inherits from A. However, the parameters available for inheritance are limited to one "inheritance direction" per parameter.

## IP parameter profiles

The profiles defined in this dialog are assigned to access points which should not retrieve an IP address by means of DHCP. This allows you to define precisely the IP parameters to be used by an access point.

The screenshot shows a dialog box titled "IP parameter profiles - New Entry". It has a standard Windows-style title bar with a close button. The dialog contains the following fields and controls:

- Name:** A text input field containing "AP-INTRANET". To its right are "OK" and "Cancel" buttons.
- Inheritance:** A section with a dropdown menu labeled "Inherit from entry:" and a text box below it labeled "Inherited values".
- Domain name:** A text input field containing "company.intern".
- Netmask:** A text input field containing "255.255.255.0".
- Default gateway:** A text input field containing "192.168.2.1".
- Primary DNS:** A text input field containing "80.123.254.1".
- Secondary DNS:** A text input field containing "0.0.0.0".

LANconfig: **WLAN Controller > AP Config. > IP parameter profile**

WEBconfig: **LCOS Menu Tree > Setup > WLAN-Management > AP-Configuration > AP-Intranets**

- **Name:** Name of the IP parameter profile
  - Possible values**
  - Maximum 31 characters
  - Default**
  - Blank
- **Inheritance:** Selection of an IP parameter profile defined earlier and from which the settings are to be inherited (*Inheritance of parameters*).
- **Domain name:** Name of the domain (DNS suffix) which is to use this profile.
  - Possible values**
  - Max. 63 characters
  - Default**
- **Netmask:** Netmask of the profile
  - Possible values**
  - Valid netmask
  - Default**
  - Blank
- **Default gateway:** The gateway to be used by the profile as standard.
  - Possible values**
  - Valid IP address
  - Default**
  - Blank
- **Primary DNS:** The DNS (Domain Name System) to be used by the profile.
  - Possible values**
  - Valid IP address

**Default**

Blank

- **Secondary DNS:** Second, alternative DNS if the first is unavailable.

**Possible values**

Valid IP address

**Default**

Blank

**List of access points**

The AP table is a central element of the configuration for WLAN controllers. Here, access points are assigned with WLAN profiles (i.e. the combinations of logical and physical WLAN parameters) via their MAC addresses. Furthermore, the existence of an entry in the AP table for an access point affects its ability to connect to a WLAN controller. The following parameters can be defined for every access point:

LANconfig: **WLAN Controller > AP Config. > Access point table**

WEBconfig: **LCOS Menu Tree > Setup > WLAN management > AP configuration > Access points**

- **Update management active**

Activating update management for the access point enables the latest firmware and script versions to be uploaded automatically. All other settings are set under AP update.

- **MAC address**

MAC address of the access point

- **AP name**  
Name of the access point in managed mode.
  - **Location**  
Location of the access point in managed mode.
  - **WLAN profile**  
WLAN profile from the list of defined profiles.
  - **WLAN interface 1**  
Frequency of the first WLAN module. This parameter can also be used to deactivate the WLAN module.
  - **Auto. channel selection lfc 1**  
Access points automatically carry out channel selection for the frequency band available in the country of operation, assuming that no entry is made here.  
  
Enter the channels to be available for automatic selection by the first WLAN module. If just one channel is defined here, then only this channel will be used and no automatic selection takes place. For this reason you should ensure that the channels entered here are legal for use in the defined country of operation. Channels which are invalid for the frequency band are ignored.
  - **WLAN interface 2**  
Frequency of the second WLAN module. This parameter can also be used to deactivate the WLAN module.
  - **Auto. channel selection lfc 2**  
Automatic channel selection for the second WLAN module.
- 
-  Settings for the second WLAN module are ignored if the managed device has only one WLAN module.
- **Encryption**  
Encryption of communications over the control channel. Without encryption the control data is exchanged as plain text. In both cases authentication is by certificate.
  - **Double bandwidth**  
LANCOM access points compliant with IEEE 802.11n optionally offer the activation of double the bandwidth.
  - **Antenna grouping**  
Antenna grouping can be configured in order to optimize the gain from spacial multiplexing.
  - **IP address**  
Here you specify the fixed IP address of the access point.
  - **IP parameter profile**  
Here you specify the profile name used to reference the IP settings for the access point. If you retain the default setting DHCP, the setting for the fixed IP address is ignored and the access point is forced to obtain its IP address via DHCP.

## Stations

The Stations table is used to specify which WLAN clients can associate with the wireless networks provided by the LANCOM access points, which in turn are centrally managed by the WLAN controller. Furthermore, the method offers a convenient way to give each WLAN client an individual authentication passphrase and a VLAN ID.

To use the station table, it is imperative that the RADIUS server is activated in the WLAN controller. As an alternative, requests can be forwarded to another RADIUS server. More information on RADIUS is available under [RADIUS](#).

For every logical WLAN in which WLAN clients are authenticated by RADIUS, the MAC check has to be activated.

LANconfig: **WLAN Controller > Stations > Stations**

WEBconfig: **LCOS Menu Tree > Setup > WLAN management > Access list**

- **MAC address:** MAC address of the WLAN client for this entry.

**Possible values**

Valid MAC address

**Default**

Blank

- **Name:** You can enter any name you wish and a comment for any WLAN client. This enables you to assign MAC addresses more easily to specific stations or users.

**Possible values**

Max. 32 characters

**Default**

Blank

- **Passphrase:** Here you may enter a separate passphrase for each physical address (MAC address) that is used in a 802.11i/WPA/AES-PSK-secured network. If no separate passphrase is specified for this MAC address, then the passphrases used are those stored for each logical wireless LAN network in the **802.11i/WEP** section (for WLAN controllers, these are defined in the logical WLAN networks (SSIDs)).

**Possible values**

ASCII character string with a length of 8 to 63 characters

**Default**

Blank

- **TX bandwidth limit:** Bandwidth restriction for registering WLAN clients. A LANCOM WLAN device in client mode communicates its setting to the access point when logging on. The base station uses these values to set the minimum bandwidth.

**Possible values**

0 to 65535 kbps

**Default**

0

**Special values**

0: No limit

- **RX bandwidth limit:** Bandwidth restriction for registering WLAN clients. A client communicates its own settings to the base station when logging in. The base station uses these values to set the minimum bandwidth.



**Possible values**

0 to 65535 kbps

**Default**

0

**Special values**

0: No limit

! The RX bandwidth restriction is only active for LANCOM WLAN devices in client mode. For value is not used by normal WLAN clients.

- **VLAN-ID:** This VLAN ID is assigned to packets that are received from the client with the MAC address entered here.

**Possible values**

0 to 4096

**Default**

0

**Special values**

In case of VLAN-ID 0, the station is not assigned a specific VLAN ID. Instead, the VLAN ID for the radio cell (SSID) applies.

**Options for the WLAN controller**

The **Options** area in the WLAN controller configuration is used to define notifications in case of events and to set various default values.

**Event notification**

Notification can take place via SYSLOG or e-mail. You can define the following parameters:

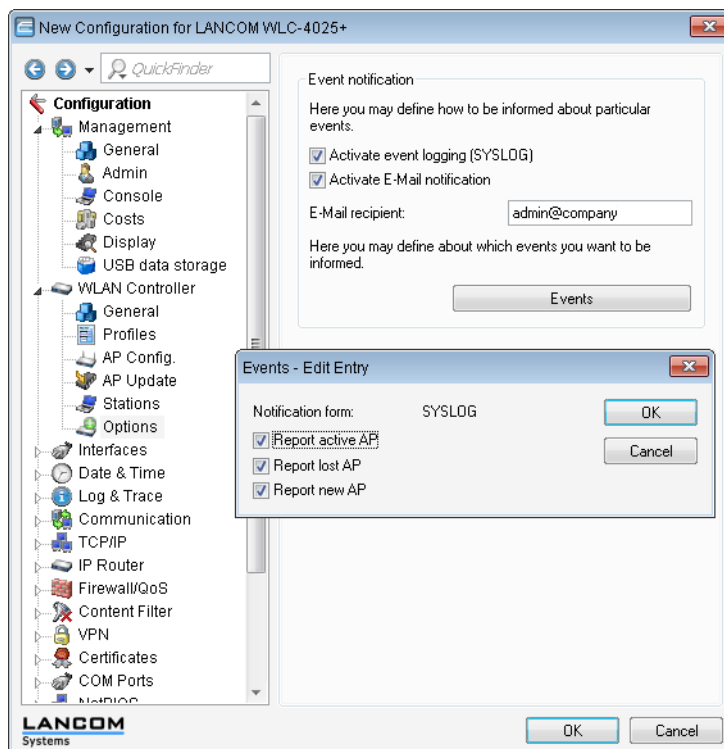

LANconfig: **WLAN Controller > Options > Event notification**

WEBconfig: **LCOS Menu Tree > Setup > WLAN management > Notification**

- **SYSLOG**

Activates notification by SYSLOG.

- Possible values: On/off.

- **E-mail**

Activates notification by e-mail.

- Possible values: On/off.

- **Events**

Selects the events that trigger notification.

- Possible values:
  - Active access point
  - Missing access point
  - New access point

### Default parameters

For some parameters, default values can be defined centrally and these serve as reference default values for other parts of the configuration.

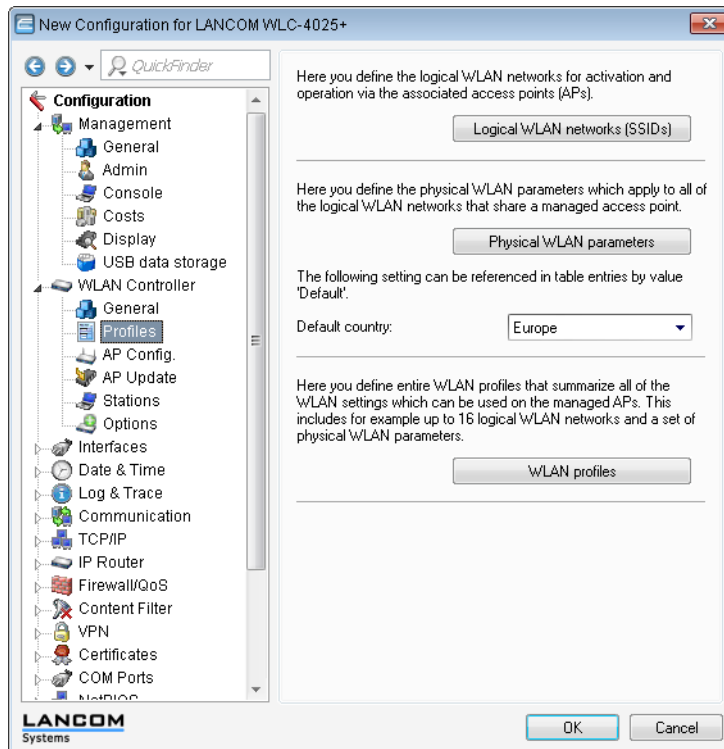

LANconfig: **WLAN Controller > Profiles > Default country**

Webconfig: **LCOS Menu Tree > Setup > WLAN Management > AP-Configuration > Country-default**

- **Default country**

The country in which the access points are to be operated. This information is used to define country-specific settings such as the permitted channels, etc.

- Possible values:
  - Selection from the list of available countries
- Default:
  - Germany

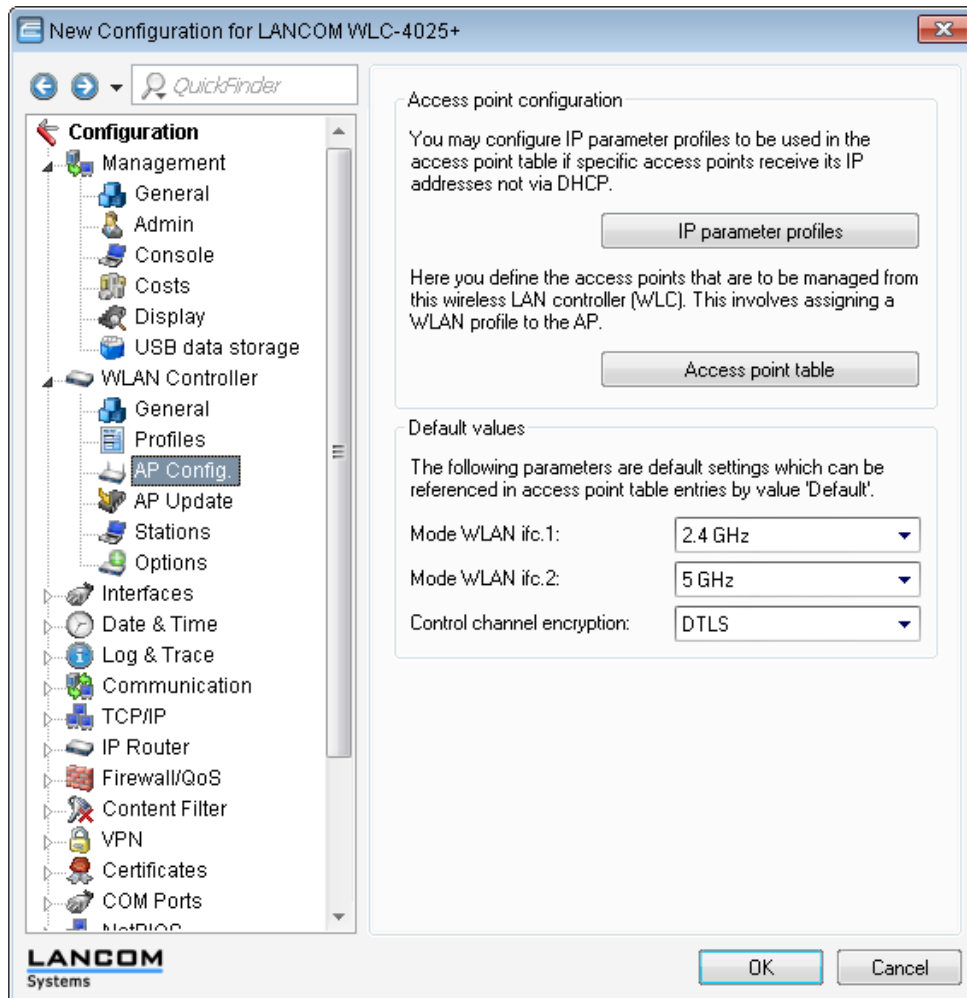

LANconfig: **WLAN Controller > AP config >**

WEBconfig: **LCOS Menu Tree > Setup > WLAN management > AP configuration**

- **WLAN interface 1**

Frequency of the first WLAN module. This parameter can also be used to deactivate the WLAN module.

- **WLAN interface 2**

Frequency of the second WLAN module. This parameter can also be used to deactivate the WLAN module.

- **Encryption**

Encryption of communications over the control channel. Without encryption the control data is exchanged as plain text. In both cases authentication is by certificate.

### 13.8.4 Tutorial: Virtualization and guest access accounts via the LANCOM WLAN controller

Many companies wish to offer Internet access to their visitors via WLAN. In larger installations the required settings apply to multiple access points, and these can be programmed centrally in the WLAN controller.

 The Public Spot Option is mandatory for this tutorial.

#### Objectives

- Wireless LAN infrastructure available to internal employees and guests
- Shared physical components (cables, switches, access points)
- Separation of networks with VLAN and ARF
- Break-out of data streams to certain target networks:
  - Guests: Internet only
  - Internal employees: Internet, all local devices and services
- Guests login to the WLAN with a Web form.
- Internal employees use WLAN encryption for authentication.

#### Establish

- Management of the access points is handled by the LANCOM WLC.
- The LANCOM WLC serves as the DHCP server for the WLAN clients in the guest network.
- The guest network is provided with Internet access via the LANCOM WLC (e.g. separate DSL access or Internet access via the company DMZ).
- The wired infrastructure is based on managed VLAN-capable switches:
  - The VLAN management of access points is handled by the LANCOM WLC.
  - The VLAN management of the switches is handled separately by the switch configuration.
- The access points operate within the internal VLANs.

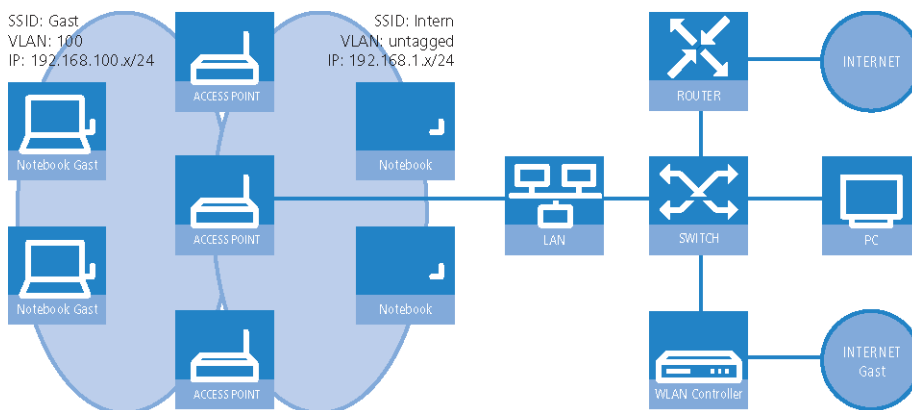

#### Wireless LAN configuration of the WLAN controllers

During the configuration of the WLAN, the necessary WLAN networks are defined and, along with the physical WLAN settings, are assigned to the access points managed by the controller.

1. Create a logical WLAN for guests and one for the internal employees:
  - The WLAN with the SSID 'GUESTS' uses the VLAN ID '100'. No encryption is employed here.

- The WLAN with the SSID 'INTERNAL' uses the VLAN ID '1' (i.e. transmitted to the Ethernet without a VLAN tag), and WPA encryption is employed.

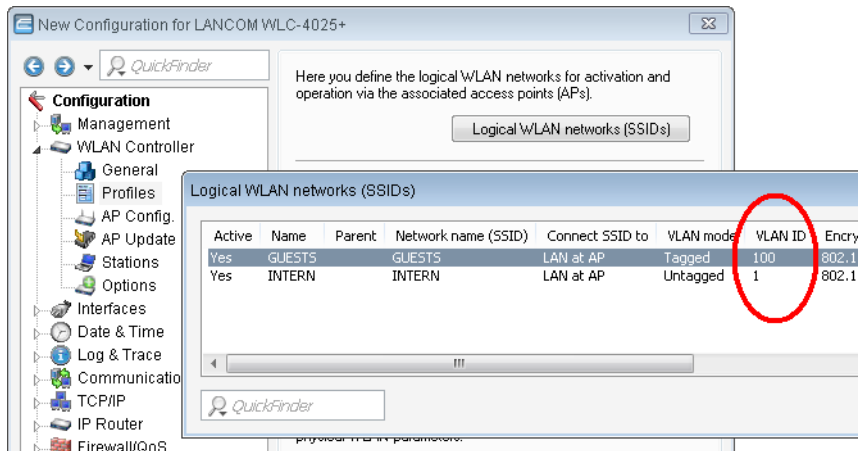

2. Create a set of physical parameters for the access points. The management VLAN ID is set to '1', which serves to activate the VLAN function (but without a separate management VLAN for the device; the management data traffic is transmitted untagged).

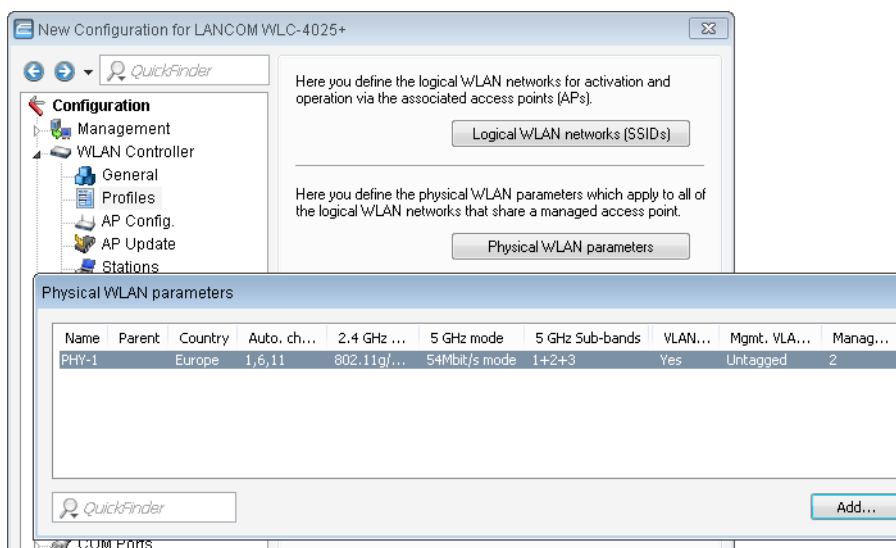

3. Create a WLAN profile to be assigned to the access points. The two logical WLAN networks and the set of physical parameters defined earlier are collected into this WLAN profile.

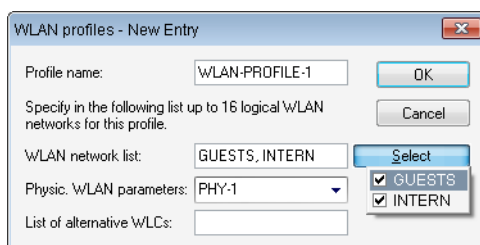

- Assign this WLAN profile to the access points managed by the controller. Do this either by entering the individual access points with their MAC addresses or, alternatively, you can use the default profile.

## Configuring the switch

A switch configuration is demonstrated with the example of a LANCOM ES-2126+.

- Set the VLAN mode to &Tag based&, as the access points handle the assignment of VLAN tags.

- To differentiate between the VLANs in the switch, two groups are used. The internal network for the employees is mapped to the default group, and a dedicated group is set up for the guests. This is handled with the VLAN IDs entered into the controller when configuring the WLANs.

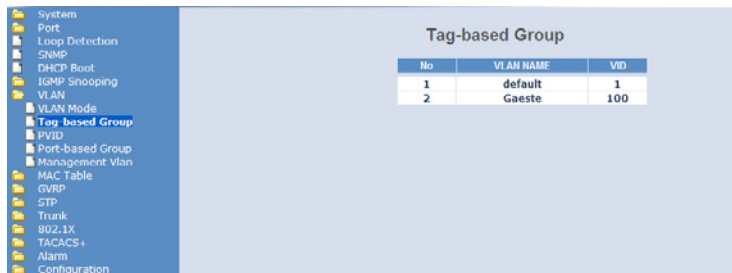

- The default VLAN is valid on all ports and remains untagged, i.e. the VLAN tags are removed from outgoing data packets from this group.

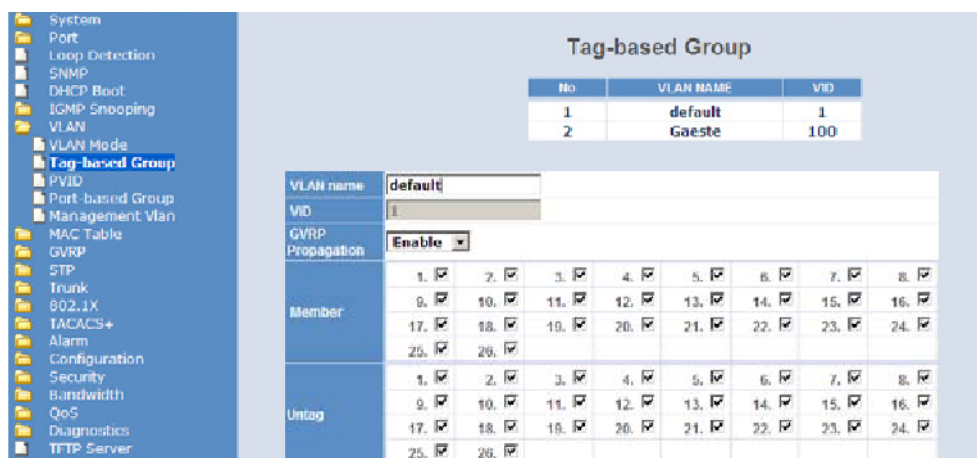

- The guests' VLAN group uses the VLAN ID '100' and is valid only for the ports connected to the WLAN controller and access points (ports 10 to 16 in our example). Tags are not removed from outgoing data packets.

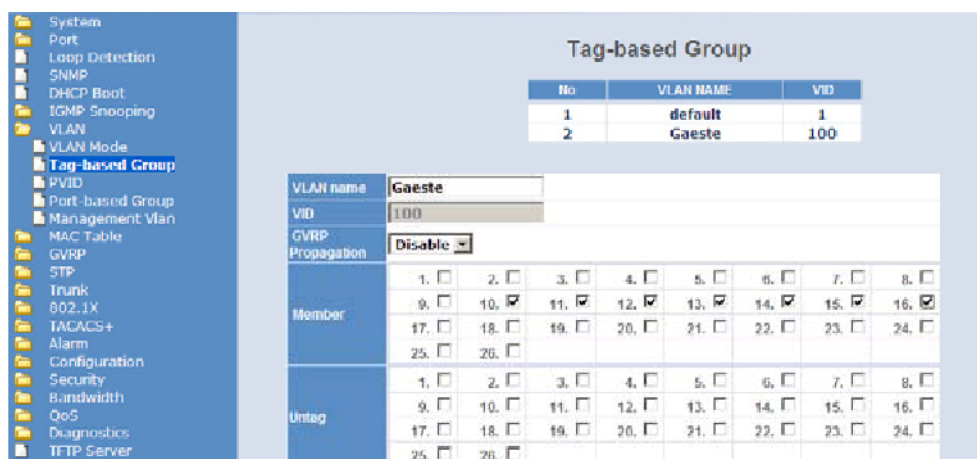

- The port VLAN ID (PVID) is set to '1' for all ports, to assign the ports to the internal network. Untagged packets arriving at these port will be forwarded with the VLAN ID '1'.

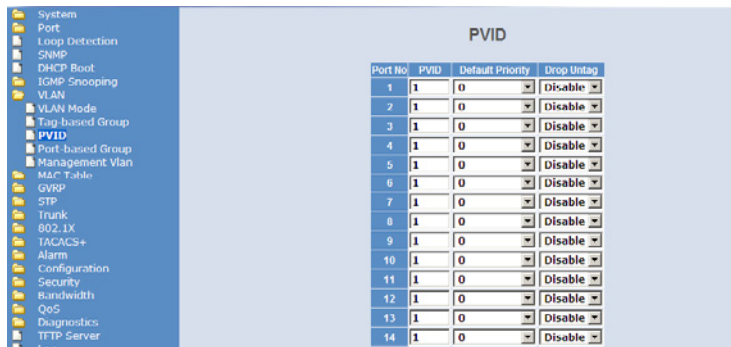

Port No	PVID	Default Priority	Drop Tag
1	1	0	Disable
2	1	0	Disable
3	1	0	Disable
4	1	0	Disable
5	1	0	Disable
6	1	0	Disable
7	1	0	Disable
8	1	0	Disable
9	1	0	Disable
10	1	0	Disable
11	1	0	Disable
12	1	0	Disable
13	1	0	Disable
14	1	0	Disable

### Configuring the IP networks in the WLAN controller

To separate the data streams on layer 3, two different IP networks are employed (ARF – Advanced Routing and Forwarding).

- Set the VLAN mode to &Tag based&, as the access points handle the assignment of VLAN tags.
  - For the internal network, set the 'Intranet' to the address '192.168.1.1'. This IP network uses the VLAN ID '0'. This assigns all untagged data packets to this network (the VLAN module in the controller itself must be activated for this). The interface tag '1' is used for the subsequent break-out of data in the virtual router.
  - For the guests, create a new IP network with the address '192.168.100.1'. This network uses the VLAN ID '100' so that data packets with this ID are assigned to the guest network. Here, too, the interface tag '10' is used later by the virtual router.

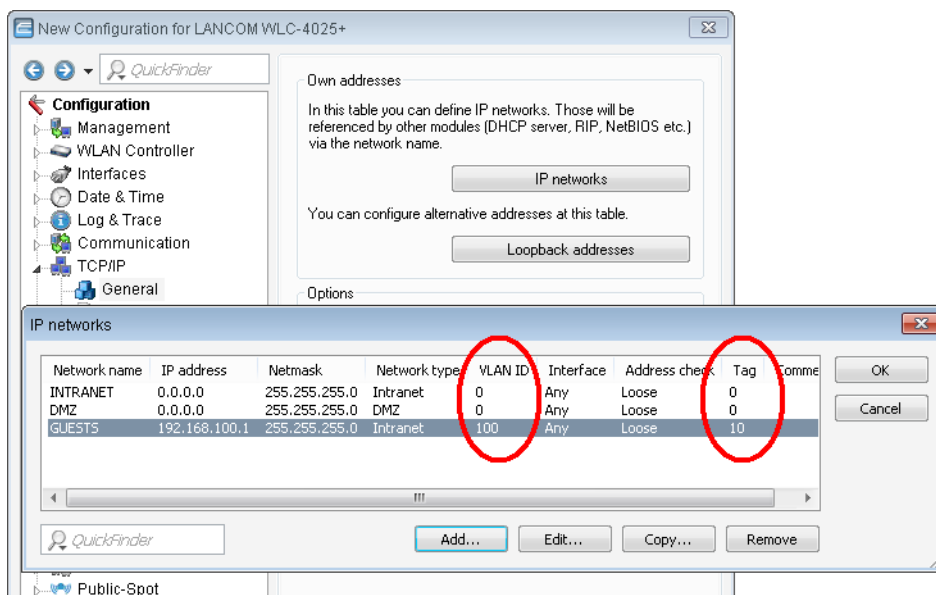



- For both IP networks, an entry is created in the DHCP networks to permanently activate the DHCP server.

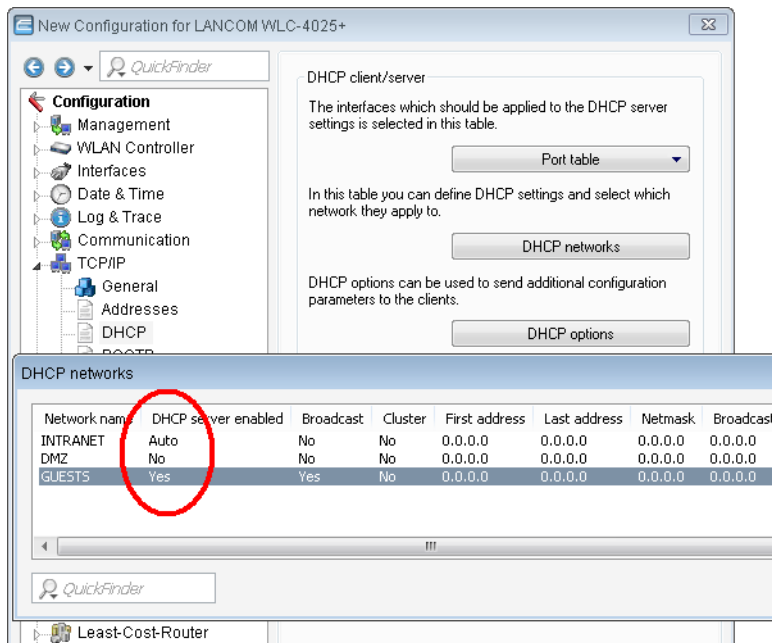

- With these settings, the WLAN clients of the internal employees and guests are assigned to the appropriate networks.

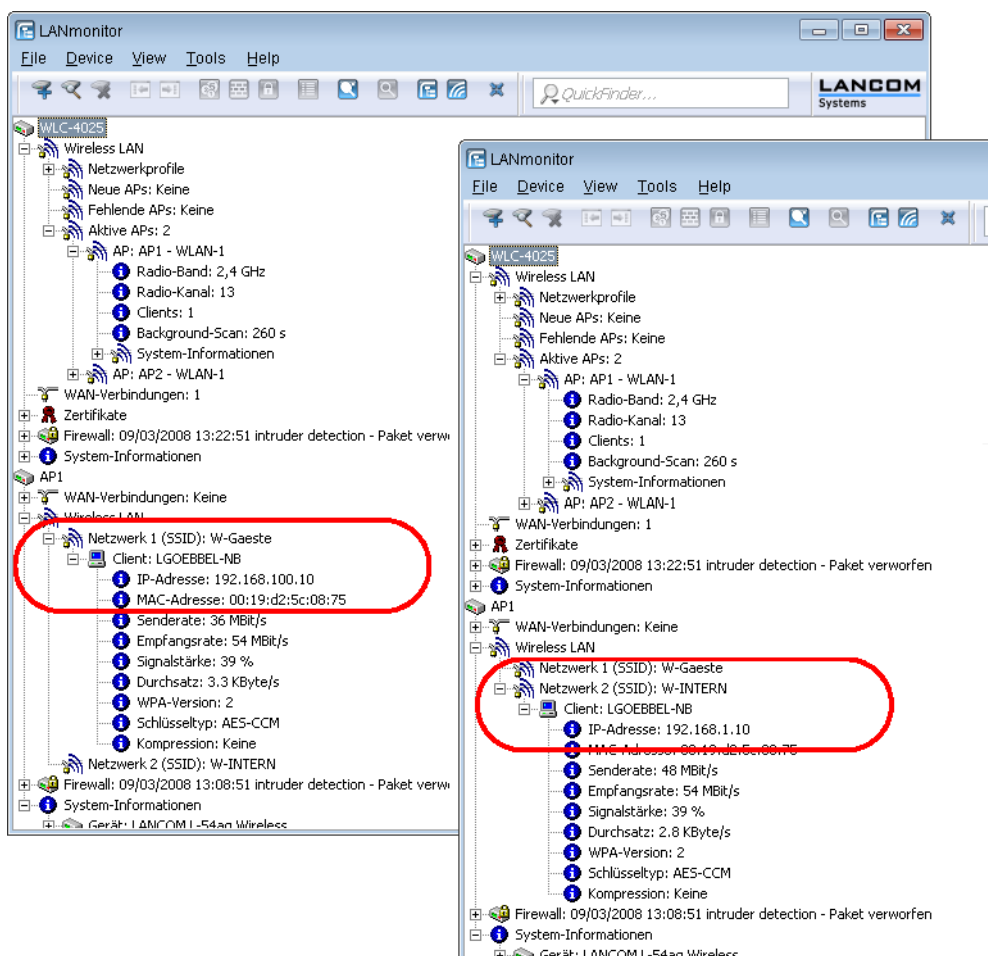

### Configuring Public Spot access

The Public Spot allows you to provide a strictly controlled point of access to your wireless LAN. User authentication is handled by a Web interface. Access can optionally be subject to time limits.

1. You should activate authentication for network access by name and password.

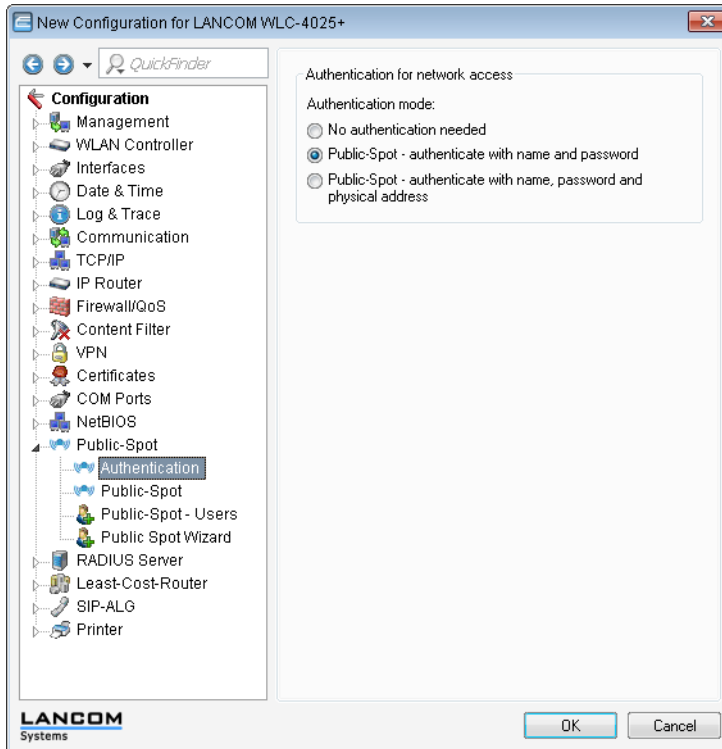

2. Activate user authentication for the controller's interface that is connected to the switch.

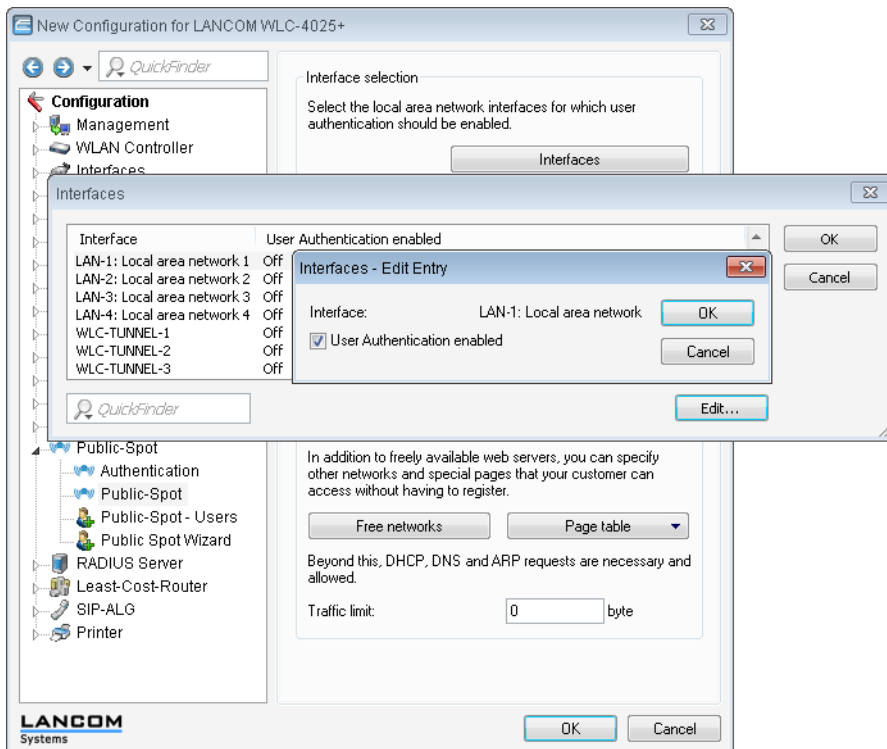

- By entering the VLAN ID of '100' for the guest network into the VLAN table, the data packets for Public Spot users are restricted to this virtual LAN. Other data packets from other VLANs will be forwarded to the Public Spot without a login. Ensure that access to WEBconfig via the Public Spot interface is restricted to the authentication pages only and that HTTP is activated in the configuration protocols.

⚠ If the interface is not restricted to the VLAN ID, the controller will no longer be reachable at the specified physical Ethernet port!

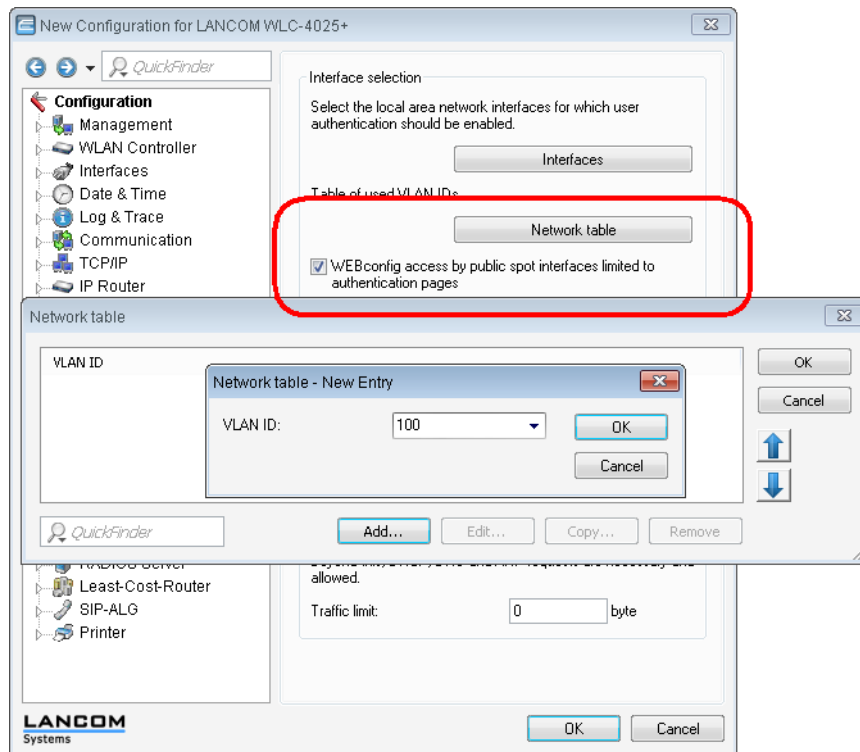

4. In the Public Spot module, activate the "Cleanup user table automatically" option to ensure that unwanted entries are automatically deleted.

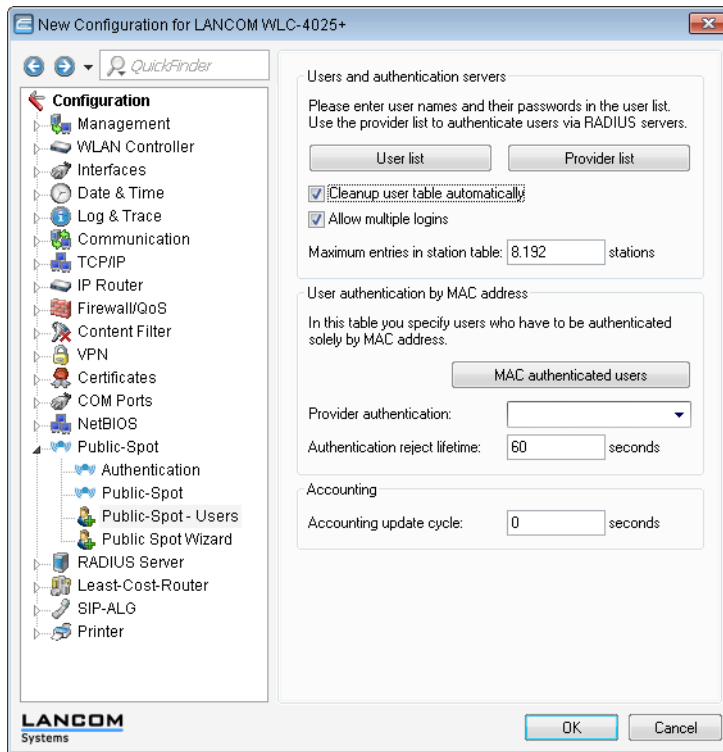

### Configuring the RADIUS server to operate a Public Spot

In LCOS versions prior to 7.70, Public Spot access accounts were defined by entering users into the Public Spot module's user list by using the Wizard. As of LCOS version 7.70, the Wizard no longer stores the Public Spot access accounts in this list, but in the user database of the internal RADIUS server instead. In order to use Public Spot access accounts, the RADIUS server must be configured and the Public Spot module must be set to use the RADIUS server.

1. In order to use the user database in the internal RADIUS server, the RADIUS server in the LANCOM must be activated first. Activate the RADIUS server by entering authentication and accounting ports. Use the authentication port '1812' and the accounting port '1813'.

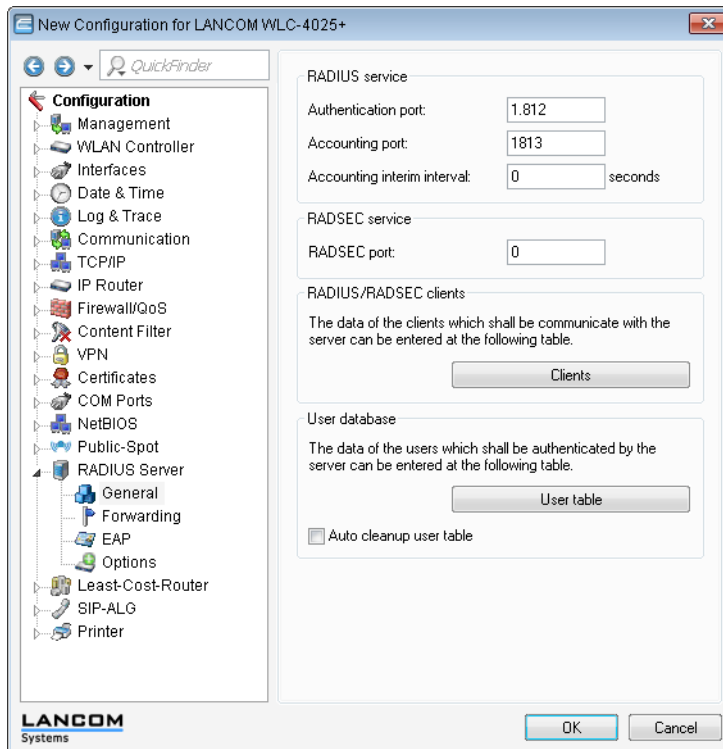

! If appropriate please activate the "Auto cleanup user table" option to ensure, that entries not used any longer can be deleted automatically from the user database.

2. In order for the Public Spot access accounts to be authenticated by the LANCOM's internal RADIUS server, the Public Spot must know the address of the RADIUS server. To ensure that this is the case, under **Public Spot > Public Spot - users > Provider list** create a new entry to define the internal RADIUS server as a "Provider". Enter the IP address for the LANCOM with the activated RADIUS server as the authentication and accounting server.

! If the Public Spot and the RADIUS server are provided by the same LANCOM, enter the device's internal loopback address (127.0.0.1) here.

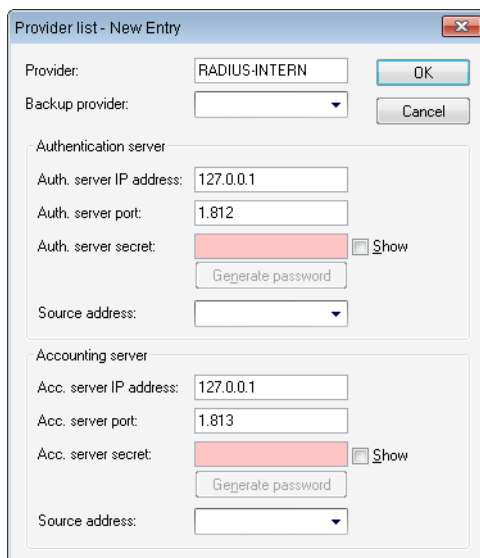

- ! After an LCOS update, user accounts that were created in the Public Spot module's user list with previous versions of LCOS are still valid.

## Configuring Internet access for the guest network

1. In order to provide users of the guest network with Internet access, the wizards can be used to create access to the provider network.
2. In order for this access to be available to users of the guest network only, the corresponding route is set for the routing tag '10'. This ensures that only data packets from the IP network 'GUEST' with the interface tag '10' are transmitted to the provider's network. The different routing tag values ensure that data cannot be routed between the guest network and the internal network.

- ! If the Public Spot and the RADIUS server are provided by the same LANCOM, enter the device's internal loopback address (127.0.0.1) here.

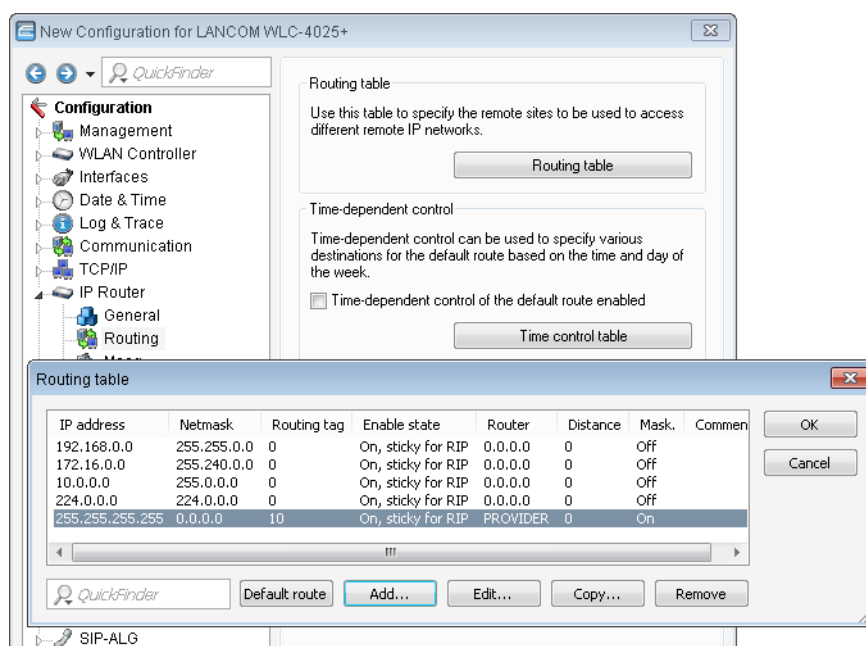

- ! After an LCOS update, user accounts that were created in the Public Spot module's user list with previous versions of LCOS are still valid.

## 13.8.5 Access point administration

### Accepting new access points into the WLAN infrastructure manually

If you prefer not to accept access points into the WLAN infrastructure automatically, you can accept access points manually.

#### Using LANmonitor to accept access points

It is very easy to accept new access points with LANmonitor. A configuration is selected that will be assigned to the access point after transmission of a new certificate.

In LANmonitor, click on the new access point with the right-hand mouse key. From the context menu that pops up, you select the configuration which is to be assigned to the device.

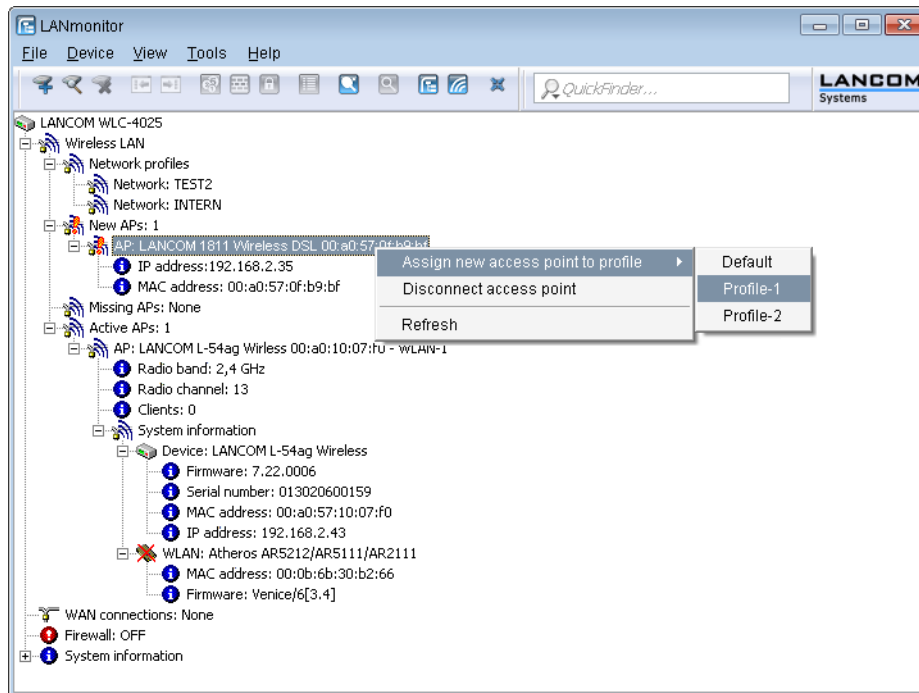

! Assignment of the configuration causes the access point to be entered into the AP table in the WLAN controller. It takes a few seconds for the WLAN controller to assign a certificate to the access point and for this to become an active element in the central WLAN infrastructure. Due to this, the newly accepted access point is briefly signaled as a "Lost AP" by the red Lost AP LED, in the device's display, and in LANmonitor until assignment of the certificate is completed.

### Accepting access points via WEBconfig with provision of a certificate

New access points that do not have a valid certificate but do have an entry in the AP table can be manually accepted with WEBconfig.

1. Open the configuration of the LANCOM WLAN controller in WEBconfig.
2. Under **LCOS Menu Tree > Setup > WLAN-Management** select the action **Accept AP**.
3. When requested for additional arguments, enter the MAC address of the access point to be accepted and confirm with **Execute**.

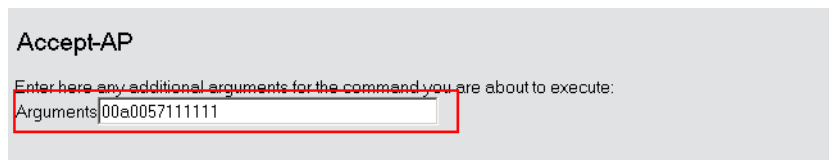

### Accepting access points via WEBconfig with provision of a certificate and configuration

New access points that do not have a valid certificate and do not have an entry in the AP table can be manually accepted by means of a wizard in WEBconfig. A configuration is selected that will be assigned to the access point after transmission of a new certificate.

1. Open the configuration of the LANCOM WLAN controller in WEBconfig. Click on **Setup Wizards** and select the wizard **Assign access points to profiles**.

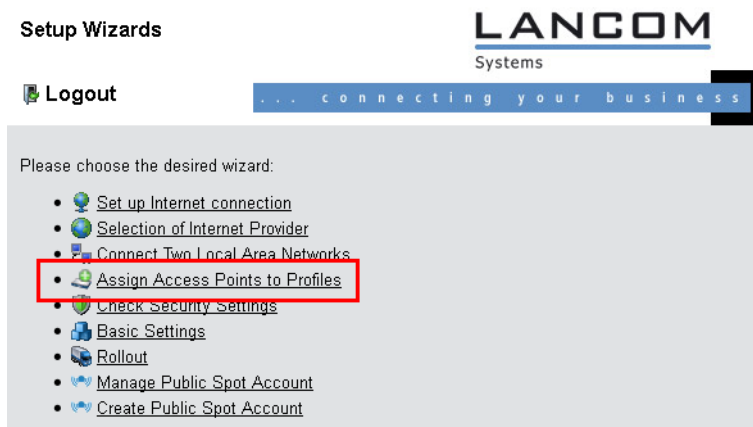

2. Click on the link to start the wizard. Select the desired access point by means of its MAC address and choose the WLAN configuration that is to be assigned to the access point.

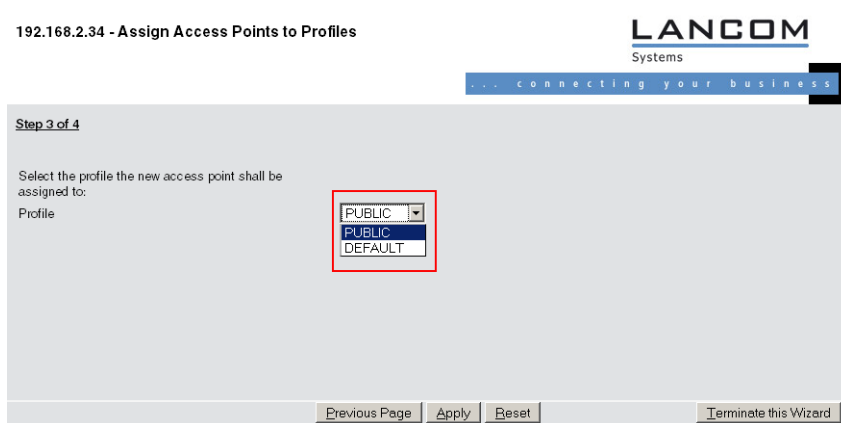

- ! Assignment of the configuration causes the access point to be entered into the AP table in the WLAN controller. It takes a few seconds for the WLAN controller to assign a certificate to the access point and for this to become an active element in the central WLAN infrastructure. Due to this, the newly accepted access point is briefly signaled as a "Lost AP" by the red Lost AP LED, in the device's display, and in LANmonitor until assignment of the certificate is completed.

### Manually removing access points from the WLAN infrastructure

The following actions are required to remove an access point under management of the WLAN controller from the WLAN infrastructure:

1. In the access point, switch the WLAN operating mode of the WLAN module from 'Managed' to 'Client' or 'Access Point'.
2. In the WLAN controller, delete the configuration for the access point and/or deactivate **Automatically provide APs with a default configuration** via **LCOS Menu Tree > Setup > WLAN-Management > Autoaccept-AP**.
3. Disconnect the access point in WEBconfig by selecting **LCOS Menu Tree > Setup > WLAN-Management** and the action **Disconnect AP**, or alternatively in LANmonitor.



- When requested for additional arguments, enter the MAC address of the access point to be disconnected and confirm with **Execute**.

#### Disconnect-AP

Enter here any additional arguments for the command you are about to execute:

Arguments | 00a057111111

### Deactivating access points or permanently removing them from the WLAN infrastructure

Occasionally it is necessary to temporarily deactivate or even permanently remove a WLAN controller-managed access point.

#### Deactivating an access point

To deactivate an access point, set its corresponding entry in the AP table to 'inactive' or delete the entry from the table. In the access point, the WLAN modules in managed mode are switched off and the corresponding SSIDs are deleted.

 The WLAN modules and the WLAN networks (SSIDs) are still switched off even if standalone operation is activated.

An access point deactivated in this way remains connected to the WLAN controller and the certificates are retained. The WLAN controller can reactivate the access point and its managed-mode WLAN modules at any time. All you have to do is to activate the entry in the AP table or make a new entry in the AP table for the corresponding MAC address.

If the connection to a deactivated access point is broken (either unintentionally due to a failure or intentionally by the administrator) then the access point begins a new search for a suitable WLAN controller. Although the former WLAN controller can check the validity of the certificate, due to the fact that there is no (active) entry in the AP table, the access point treats it as a secondary WLAN controller. If the access point finds a primary WLAN controller then it will register with it.

#### Permanently removing an access point from the WLAN infrastructure

In order to permanently remove an access point from a centrally managed WLAN infrastructure, the certificates in the SCEP client have to be either deleted or revoked.

- If you have access to the access point, the certificates are quickly deleted by resetting the device.
- If the device has been stolen and consequently needs to be removed from the WLAN infrastructure, then the certificates in the WLAN controller's CA have to be revoked. This is done in WEBconfig by navigating to **Status > Certificates > SCEP-CA > Certificates** and accessing the **Certificate status table**. Here you delete the certificate for the MAC address of the access point which is to be removed from the WLAN infrastructure. The certificates are not actually deleted, but they are marked as expired.

 In case of a backup solution featuring redundant WLAN controllers, the certificates have to be revoked in all of the WLAN controllers!

### 13.8.6 Central firmware and script management

LANCOM WLAN controllers allow the configurations of multiple LANCOM WLAN routers and LANCOM access points to be managed from a central location in a consistent and convenient manner. With central firmware and script management, uploads of firmware and scripts can be automated for all of the WLAN devices.

To achieve this, the firmware and script files are stored on a Web server (firmware as \*.upx files, scripts and \*.lcs files). The WLAN controller checks once daily, or when prompted by a user, to compare the available files with those on the devices. Alternatively, this procedure can be handled by a cron job—overnight, for example. If an update can be carried out, or if the access point is not running the desired firmware version, then the WLAN controller downloads the file from the Web server and uploads it to the appropriate WLAN routers and access points.

The configuration of firmware and script management provides precise control over the distribution of the files. It is possible, for example, to limit certain firmware versions to certain device types or MAC addresses.

An update can be carried out in two possible states:

- When a connection is established; the access point subsequently restarts automatically.
- If the access point is already connected, the device does not restart automatically. In this case the access point is manually restarted with the menu action **Setup > WLAN-Management > Central-Firmware-Management > Reboot-updated-APs** or by a timed cron job.
- The action **Setup > WLAN-Management > Central-Firmware-Management > Update-Firmware-and-Script-Information** updates the script and firmware directories.

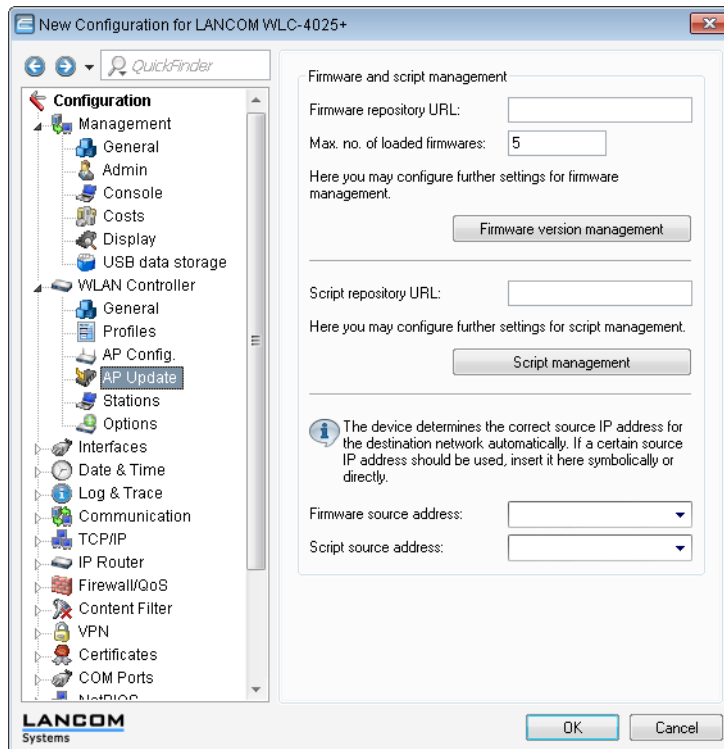

The parameters for configuration can be found under the following paths:

LANconfig: **WLAN Controller > AP Update**

WEBconfig: **Setup > WLAN-Management > Central-Firmware-Management**

### General settings for firmware management

#### ■ Firmware URL

The path to the directory with the firmware files.

- Possible values: URL in the form `Server/Directory` or `http://Server/Directory`
- Default: Blank

#### ■ Simultaneously loaded FW

The number of firmware versions loaded simultaneously into the main memory of the WLAN controller.



The firmware versions stored here are downloaded from the server just once and then used for all update processes.

- Possible values: 1 to 10
- Default: 5

#### ■ Firmware sender IP address

This is where you can configure an optional sender address for use instead of the one automatically selected for the destination address.

Possible values:

- Name of a defined IP network.
- 'INT' for the IP address in the first network with the setting 'Intranet'.
- 'DMZ' for the IP address in the first network with the setting 'DMZ'.
- Name of a loopback address.
- Any other IP address.

Default:

- Blank



If the list of IP networks or loopback addresses contains an entry named 'INT' or 'DMZ', the associated IP address of the IP network or the loopback address named 'INT' or 'DMZ' is used.

#### Firmware management table

Table with device type, MAC address and firmware version for the precise control of the firmware files in use.

##### ■ Device types

Select here the type of device that the firmware version specified here is to be used for.

- Possible values: All, or a selection from the list of available devices.
- Default: All

##### ■ MAC address

Select here the device (identified by its MAC address) that the firmware version specified here is to be used for.

- Possible values: Valid MAC address
- Default: Blank

##### ■ Version

Firmware version that is to be used for the devices or device types specified here.

- Possible values: Firmware version in the form X.XX
- Default: Blank

#### General settings for script management

##### ■ Script URL

The path to the directory with the script files.

- Possible values: URL in the form `Server/Directory` or `http://Server/Directory`
- Default: Blank

##### ■ Script sender IP address

This is where you can configure an optional sender address for use instead of the one automatically selected for the destination address.

Possible values:

- Name of a defined IP network.
- 'INT' for the IP address in the first network with the setting 'Intranet'.
- 'DMZ' for the IP address in the first network with the setting 'DMZ'.

- Name of a loopback address.
- Any other IP address.

Default:

- Blank



If the list of IP networks or loopback addresses contains an entry named 'INT' or 'DMZ', the associated IP address of the IP network or the loopback address named 'INT' or 'DMZ' is used.

### Script management table

Table with the name of the script file and a WLAN profile for allocating the script to a WLAN profile.

Configuring a WLAN router and access point in the "Managed" mode is handled via WLAN profiles. A script can be used for setting those detailed parameters in managed devices that are not handled by the pre-defined parameters in a WLAN profile. Distribution is also handled by WLAN profiles to ensure that the wireless routers and access points with the same WLC configuration also use the same script.

As only one script file can be defined per WLAN profile, versioning is not possible here. However, when distributing a script to a wireless router or access point, an MD5 checksum of the script file is saved. This checksum allows the WLAN Controller to determine whether the script file has to be transmitted again in case a new or altered script has the same file name.

#### ■ Script file name

Name of the script file to be used.

- Possible values: File name in the form \*.lcs
- Default: Blank

#### ■ WLAN profile

Select here the WLAN profile that the script file specified here should be used for.

- Possible values: Selection from the list of defined WLAN profiles.
- Default: Blank

### Internal script storage (script management without an HTTP server)

In contrast to firmware files, scripts involve only small volumes of data. The WLAN controller's internal script storage allows three scripts of up to 64KB each to be stored. If script requirements do not exceed this volume, an HTTP server does not need to be configured for this purpose.

Script files are simply loaded from the designated storage location using WEBconfig. After upload the list of available scripts must be updated with **Setup > WLAN-Management > Central-Firmware-Management > Update Firmware and Script Information**.

The internal scripts can be referenced from the script management table using the relevant names (WLC\_Script\_1.lcs, WLC\_Script\_2.lcs or WLC\_Script\_3.lcs).

! Please be careful with upper and lower case letters when entering script names.

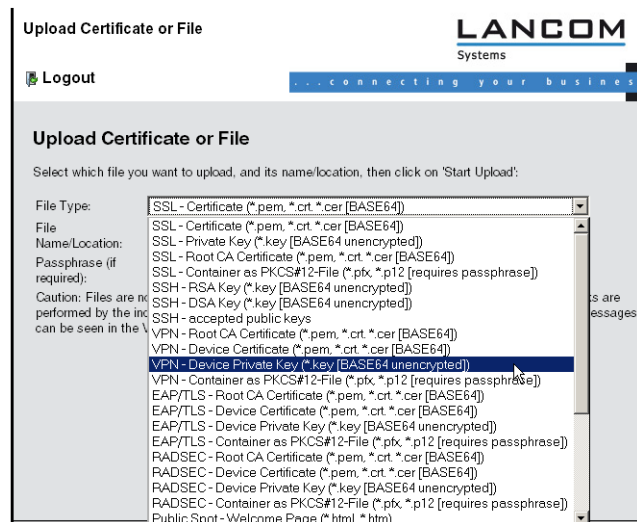
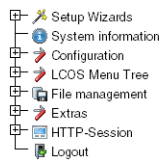

### 13.8.7 WLAN layer-3 tunneling

#### Introduction

The CAPWAP standard for centralized WLAN management offers two different channels for transmissions:

- The obligatory control channel transports administrative data between the managed access point and the WLAN controller.
- The optional data channel transmits the payload data from the various WLAN networks (SSID) between the managed access point and the WLAN controller.

The decision whether to use of the optional data channel between the managed access point and the WLAN controller depends on the route to be taken by the payload data:

- If you deactivate the data channel, the access point forwards the payload data directly to the LAN. In this case, you control the allocation of WLAN clients to specific LAN segments, for example by assigning VLAN IDs. The advantage of this application lies in the low load on the controller and on the network as a whole, because the access point transmits only the management data via the CAPWAP tunnel and it transmits the payload data over the shortest available route.
- If you activate the data channel, the access point additionally forwards the payload data to the central WLAN controller. This approach has the following advantages:
  - The access points can provide access to networks that are only available on the WLAN controller, such as a central Internet access for a Public Spot.
  - The WLANs provided by the access points (SSIDs) can be separated from one another without the use of VLAN. Avoiding the use of VLAN reduces the effort required for the configuration of other network components such as switches, etc.
  - WLAN clients associated with the access points and in different IP networks can roam to other access points without interruption to their IP connections, because the connection is continually managed by the central controller and not by the access points (layer-3 roaming).

The use of data channels forms additional logical networks on the basis of the existing physical infrastructure. These logical networks are known as overlay networks.

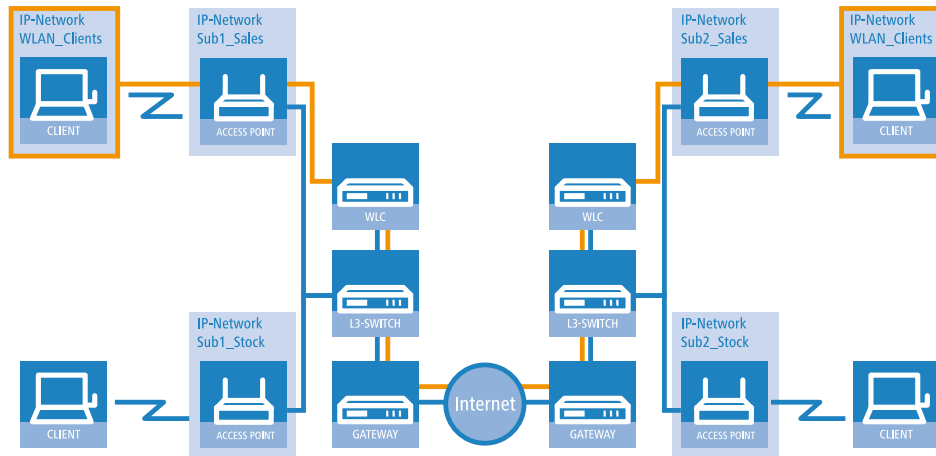

Overlay network across multiple IP networks

Using the data channel even allows you to span logical overlay networks across multiple WLAN controllers.

Several WLCs within a single broadcast domain can support the same overlay network. Disable the WLC data channel between these controllers (WEBconfig: LCOS Menu Tree > Setup > WLAN-Management > WLC-Cluster > WLC-Data-Tunnel-active). Otherwise the multiple reception of the broadcast messages would give rise to loops. Since routers discard broadcast messages, you can activate the CAPWAP data channel for controllers in separate networks.

The access points use virtual WLC interfaces (WLC tunnels) to manage each SSID's data channels between access point and WLAN controller. Depending on the model, each WLAN controller provides 16 to 32 WLC tunnels that you can use when configuring the logical WLANs.

! Virtual WLC interfaces are available for selection in all dialogs used to select logical interfaces (LAN or WLAN), such as in the port table of the LAN and VLAN settings or for the definition of IP networks.

## Tutorials

The following sections present specific scenarios with step-by-step instructions for a number of standard situations when operating WLAN controllers.

### Overlay network: Separating networks for access points without using VLAN

In many cases, networks in a shared physical infrastructure are separated by using VLANs. However, this method assumes that the switches operated in the network are VLAN-capable and that these are configured for VLAN operations. Consequently, the administrator has to rollout the VLAN configuration for the whole network.

WLAN controllers enable you to separate the networks while minimizing the use of VLANs. The access points use a CAPWAP data tunnel to direct the payload from the WLAN clients straight to the controller, which then assigns the data to the corresponding VLANs. In this situation, VLAN configuration is only required for the controller and a single, central switch. All of the other switches in this example work without a VLAN configuration.

! With this configuration, you reduce the VLAN to the core of the network structure (illustrated with a blue background). What's more, only 3 of the switch ports in use require a VLAN configuration.

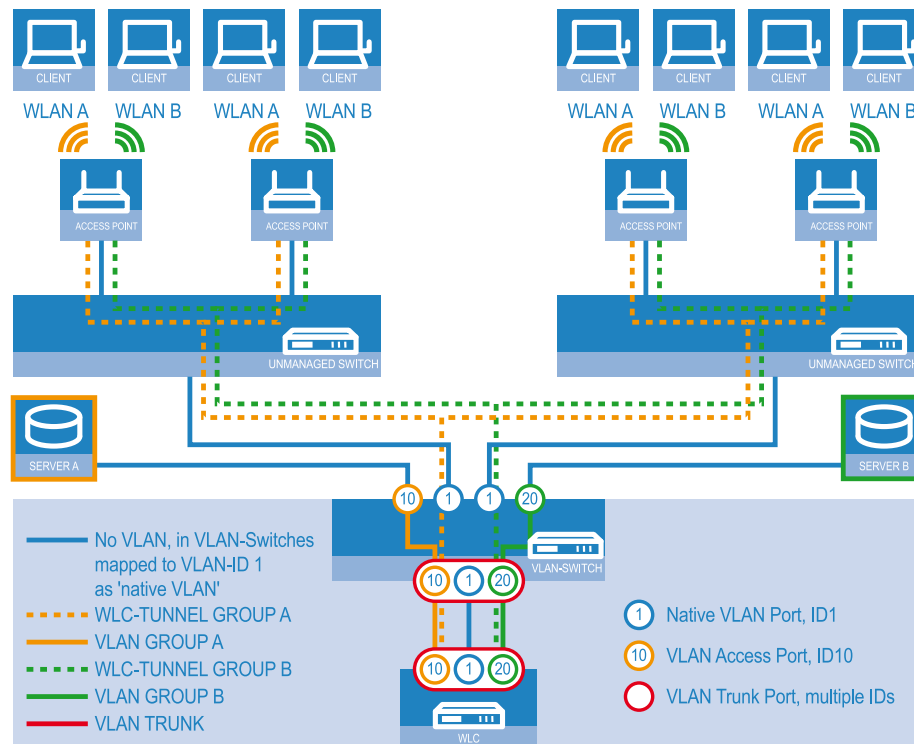

#### Example application: Overlay network

The diagram shows a sample application with the following components:

- The network consists of two segments, each with its own (not necessarily VLAN-capable) switch.
- Each segment contains several access points, each of which is connected to one of the switches.
- Each access point provides two SSIDs for the WLAN clients in two different user groups, shown in the diagram in green and orange.
- Each user group has access to its own dedicated server that is separated from other user group. The servers can only be accessed via the corresponding VLANs, i.e. through the access ports configured on the switch.
- A single WLAN controller manages all of the access points in the network.
- A central, VLAN-capable switch connects the switches in each segment, the servers for each group, and the WLAN controller.

The aim of the configuration: A WLAN client that associates with an SSID is to have access to its "own" server, regardless of which access point is being used and regardless of the segment in which the client is located.

! The following description assumes a working basic configuration of the WLAN controller. The configuration of the VLAN switch is not part of this description.

#### Configuring the WLAN settings

1. For each SSID, create an entry in the list of logical networks. This entry requires a suitable name and the corresponding SSID. Connect the SSID to a WLC tunnel, for example the first SSID to "WLC-TUNNEL-1" and the second to "WLC-TUNNEL-2". Set the VLAN mode to 'tagged', set the VLAN ID '10' for the first logical network and the VLAN

ID '20' for the second logical network. In LANconfig you find these settings under **Configuration > WLAN Controller > Profiles > Logical WLAN networks (SSIDs)**.

#### Logical WLAN networks for overlay networks

2. Create an entry in the list of physical WLAN parameters with the appropriate settings for your access points, such as the country 'Europe' with the channels 1, 6 and 11 in 802.11b/g/n and 802.11a/n in mixed mode. For this profile in the physical WLAN parameters, enable the option to turn on the VLAN module on the access points. Set the operating mode for the management VLAN in the access points to 'Untagged'. In LANconfig you find these settings under **Configuration > WLAN Controller > Profiles > Physical WLAN parameters**.



### Physical WLAN parameters for overlay networks

3. Create a WLAN profile and give it a suitable name. Then assign the logical WLAN networks and the physical WLAN parameters created previously to this WLAN profile. In LANconfig you find these settings under **Configuration > WLAN Controller > Profiles > WLAN profiles**.

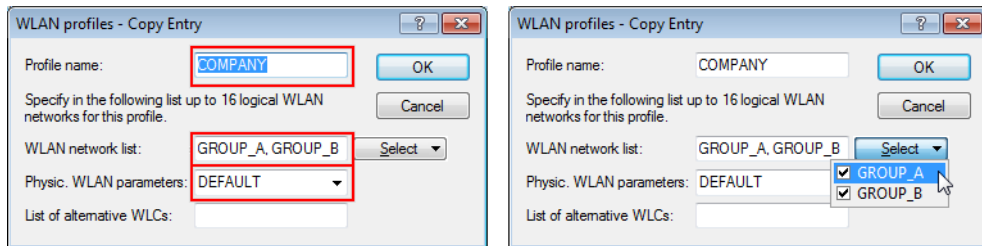

### WLAN profiles for overlay networks

4. For each managed access point, create an entry in the access point table with a suitable name and the associated MAC address. Assign the WLAN profile created previously to this access point. In LANconfig you find these settings under **Configuration > WLAN Controller > AP config. > Access point table**.

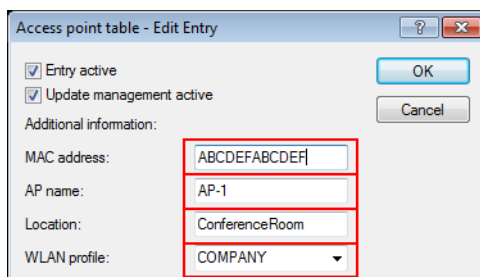

### Access point table for overlay networks

## Configuring the interfaces on the WLC

- Assign a separate logical LAN interface, e.g. 'LAN-1', to each physical Ethernet port. Make sure that the other Ethernet ports are not assigned to the same LAN interface. In LANconfig you find these settings under **Configuration > Interfaces > LAN > Ethernet ports**.

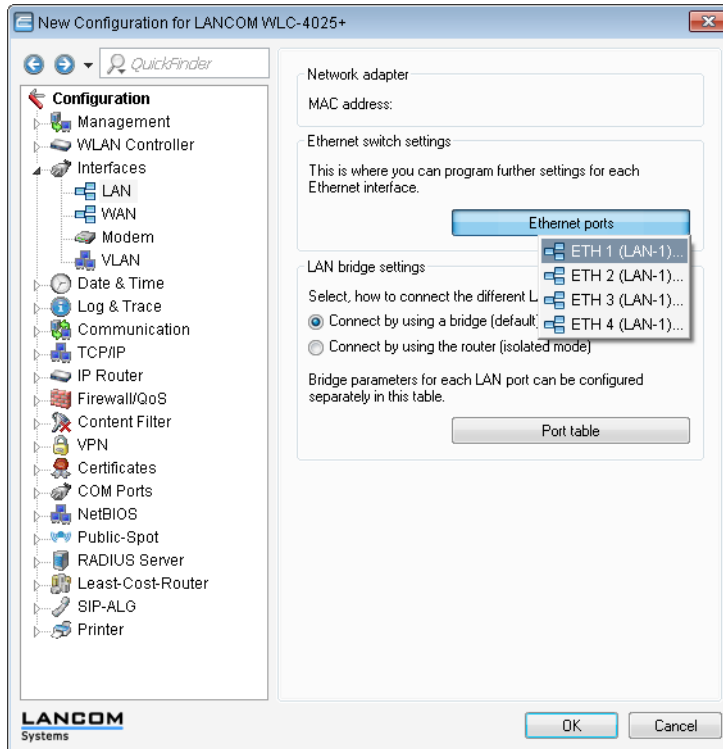

Ethernet setting for overlay networks

- Assign the logical LAN interface 'LAN-1' and the WLC tunnels 'WLC-tunnel-1' and 'WLC-tunnel-2' to the bridge-group 'BRG-1'. Make sure that the other LAN ports are not assigned to the same bridge group. In LANconfig you find these settings under **Configuration > Interfaces > LAN > Port table**.

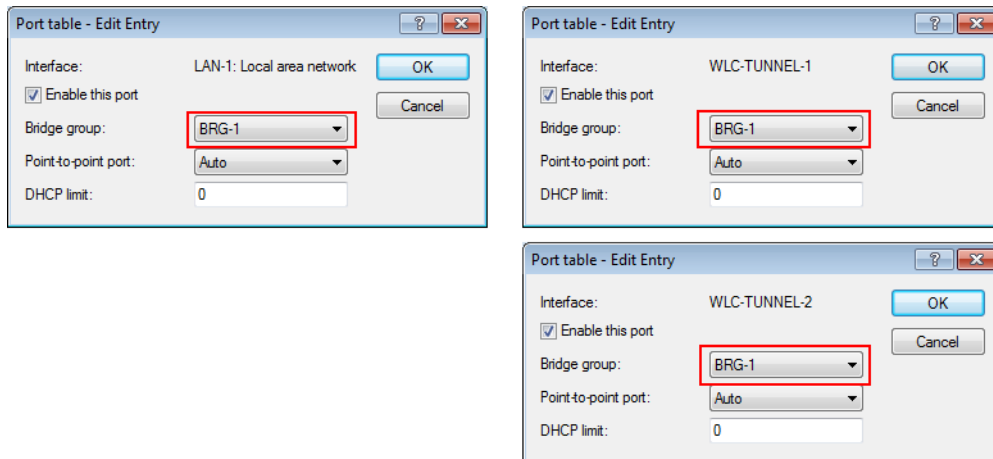

Port settings for overlay networks

**!** By default, the LAN interfaces and WLC tunnels do not belong to a bridge group. By assigning the LAN interface 'LAN-1' and the two WLC tunnels 'WLC-Tunnel-1' and 'WLC-Tunnel-2' to the bridge group 'BRG-1', the device transmits all data packets between LAN-1 and the WLC tunnels via the bridge.

7. The WLAN controller can optionally act as a DHCP server for the access points. To set this up, activate the DHCP server for the 'INTRANET'. In LANconfig you find these settings under **Configuration > TCP > DHCP > DHCP networks**.

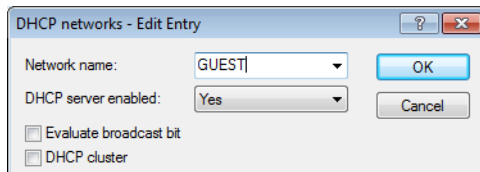

DHCP settings for overlay networks

### Layer-3 roaming

Allowing payload data from the wireless LAN to pass-through the WLC tunnel to the controller enables roaming even beyond the limits of broadcast domains. In this example application, a layer-3 switch between the floors prevents the transmission of broadcasts, and thus separates the broadcast domains.

In this example, two user groups A and B each have access to their own WLAN (SSID). On all floors of the building, the access points provide two SSIDs, 'GROUP\_A' and 'GROUP\_B'.

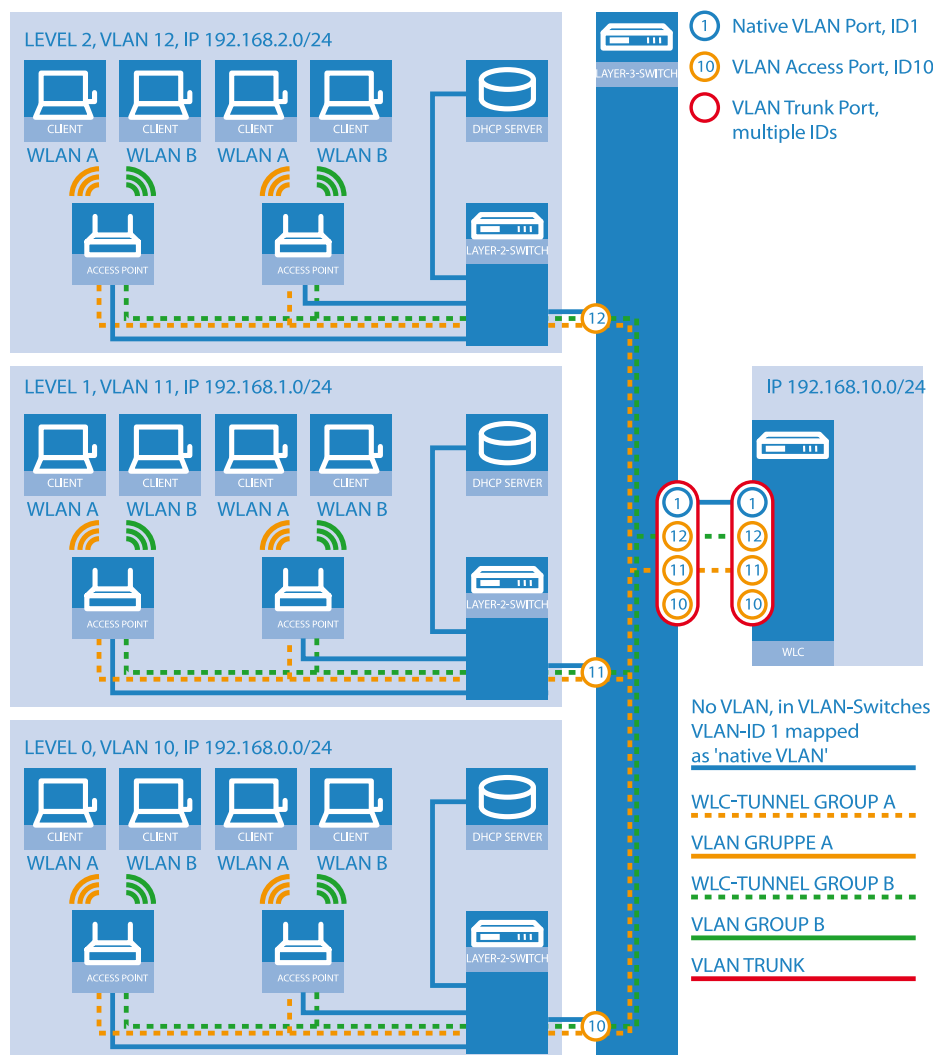

Example application: Layer-3 roaming

The diagram shows a sample application with the following components:

- The network consists of three segments on separate floors of a building.
- A central layer-3 switch connects the segments and divides the network into three broadcast domains.
- Each segment uses its own IP address space and its own VLAN.
- Each segment operates a local DHCP server, which transmits the following information to the access points:
  - IP address of the gateway
  - IP address of the DNS server
  - Domain suffix



This information enables the access points to contact the WLC controller in another broadcast domain.

The aim of the configuration: When moving to another floor, a WLAN client that associates with a particular SSID is to retain access to its "own" WLAN, regardless of which access point is being used and regardless of the segment in which the client is located. Since the segments in this example use different IP address ranges, this scenario can only be implemented by managing the access points directly with the central WLAN controller via layer 3 and across the boundaries of the VLANs.



The configuration corresponds to the example [Overlay network: Separating networks for access points without using VLAN](#) on page 822.

### WLAN controller with Public Spot

This scenario is based on the first scenario (overlay network) and enhances it to include specific settings for user authentication.

The configuration of a Public Spot can be greatly simplified if the payload data sent from the WLAN to the controller is routed through a WLC tunnel. A Public Spot can, for example, provide guests with Internet access in parallel with, but separated from, an internal wireless LAN.

In this example, the employees of a company have access to a private WLAN (SSID), while the guests use a Public Spot to access the Internet. In all areas of the building, the access points provide two SSIDs, 'COMPANY' and 'GUESTS'.

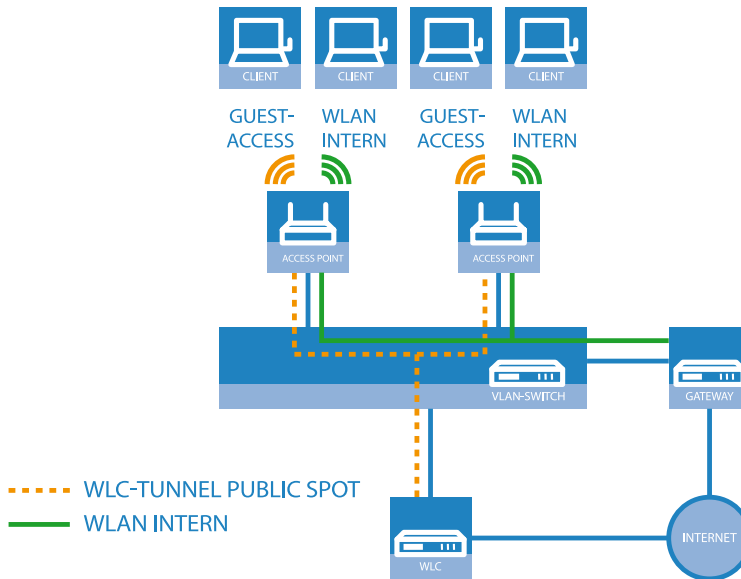

Example application: WLAN controller with Public Spot

The aim of the configuration: A WLAN client that associates with the internal SSID should have access to all internal resources and the Internet via the central gateway. The access points break-out the payload data from the internal clients locally and pass it on directly to the LAN. The guests' WLAN clients associate with the Public Spot. The access points send the payload data from the guest clients through a WLC tunnel directly to the WLAN controller, which uses a separate WAN interface for Internet access.

1. The internal WLAN and the guest WLAN each require an entry to be created in the list of logical networks, each with a suitable name and the corresponding SSID. Link the SSID for internal use with the 'LAN at AP', and the SSID for guests with (for example) 'WLC-TUNNEL-1'. Disable encryption for the guest network SSID so that the guests' WLAN clients can associate with the Public Spot. You should also prevent inter-station traffic for this SSID. In LANconfig you find this setting under **Configuration > WLAN Controller > Profiles > Logical WLAN networks (SSIDs)**.

The screenshot shows the configuration window for a logical WLAN network. The following settings are highlighted with red boxes:

- Name:** COMPANY
- Network name (SSID):** WLAN-INTERN
- Connect SSID to:** LAN at AP
- Encryption:** 802.11i (WPA)-PSK

Other visible settings include: Logical WLAN network activated (checked), Inheritance (empty), VLAN mode (Untagged), VLAN ID (2), Key 1/passphrase (redacted), Allowed frequency bands (2.4/5 GHz (802.11a)), AP standalone time (0 minutes), MAC check activated (unchecked), Suppress SSID broadcast (No), RADIUS accounting activated (unchecked), Allow data traffic between stations of this SSID (checked), WPA version (WPA1/2), WPA1 session key type (TKIP), WPA2 session key type (AES), Broadcast rate (2 Mbit/s), Client Bridge Support (No), Maximum count of clients (0), Use long preamble for 802.11b (unchecked), 802.11n Max. spatial streams (Auto), Allow short guard interval (checked), and Use frame aggregation (checked).

#### Logical WLAN networks for internal use

The screenshot shows the configuration window for a logical WLAN network. The following settings are highlighted with red boxes:

- Name:** GUESTS
- Network name (SSID):** WLAN-PUBLIC
- Connect SSID to:** WLC-TUNNEL-1
- Encryption:** None

Other visible settings include: Logical WLAN network activated (checked), Inheritance (empty), VLAN mode (Untagged), VLAN ID (2), Key 1/passphrase (redacted), Allowed frequency bands (2.4/5 GHz (802.11a)), AP standalone time (0 minutes), MAC check activated (unchecked), Suppress SSID broadcast (No), RADIUS accounting activated (unchecked), Allow data traffic between stations of this SSID (unchecked), WPA version (WPA1/2), WPA1 session key type (TKIP), WPA2 session key type (AES), Broadcast rate (2 Mbit/s), Client Bridge Support (No), Maximum count of clients (0), Use long preamble for 802.11b (unchecked), 802.11n Max. spatial streams (Auto), Allow short guard interval (checked), and Use frame aggregation (checked).

### Logical WLAN networks for guest access accounts

2. Create an entry in the list of physical WLAN parameters with the appropriate settings for your access points, such as the country 'Europe' with the channels 1, 6 and 11 in 802.11b/g/n and 802.11a/n in mixed mode. In LANconfig you find this setting under **Configuration > WLAN Controller > Profiles > Physical WLAN parameters**.

Physical WLAN parameters - Edit Entry

Name: DEFAULT

Inheritance

Inherit from entry: [dropdown]

Inherited values: [dropdown]

Country: Europe

Auto. channel selection: 1, 6, 11

2.4 GHz mode: 802.11g/b/n (mixed)

5 GHz mode: 802.11a/n (mixed)

5 GHz Sub-bands: 1+2

DTIM period: 1

Background scan: 0 seconds

Antenna gain: 3 dBi

TX power reduction: 0 dB

VLAN module of the managed accesspoints activated

Mgmt. VLAN mode: Untagged

Management VLAN-ID: 2

Enable QoS according to 802.11e (WME)

Indoor only mode activated

Report clients activated

### Physical WLAN parameters for Public Spot APs

3. Create a WLAN profile and give it a suitable name. Then assign the logical WLAN networks and the physical WLAN parameters created previously to this WLAN profile. In LANconfig you find this setting under **Configuration > WLAN Controller > Profiles > WLAN profiles**.

WLAN profiles - Edit Entry

Profile name: COMPANY

Specify in the following list up to 16 logical WLAN networks for this profile.

WLAN network list: COMPANY, GUEST

Physic. WLAN parameters: DEFAULT

List of alternative WLCs: [text area]

### WLAN profiles for Public Spot APs

- For each managed access point, create an entry in the access point table with a suitable name and the associated MAC address. Assign the WLAN profile created previously to this access point. In LANconfig you find this setting under **Configuration > WLAN Controller > AP config. > Access point table**.

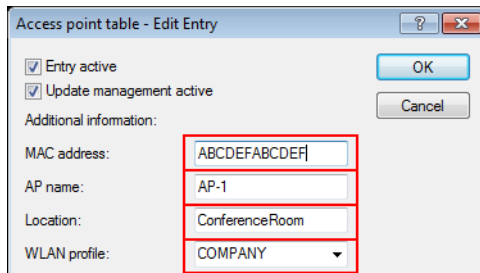

#### Access point table for Public Spot APs

- Assign a separate logical LAN interface, e.g. 'LAN-1', to each physical Ethernet port. Set the 4th Ethernet port to the logical interface 'DSL-1'. The WLAN controller will use this LAN interface for the guest network Internet access. In LANconfig you find this setting under **Configuration > Interfaces > LAN > Ethernet ports**.

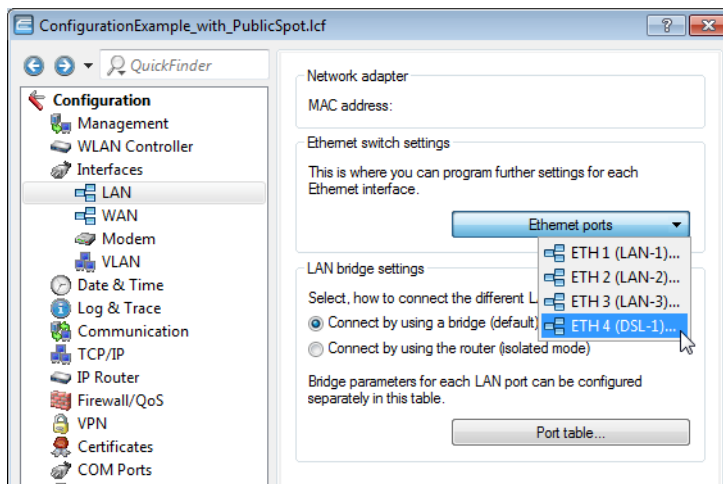

#### Ethernet settings for Public Spot APs

- Verify that the logical LAN interface 'WLC-tunnel-1' is not allocated to a bridge group. This ensures that the other LAN interfaces do not transmit any data to the Public Spot. In LANconfig you find this setting under **Configuration > Interfaces > LAN > Port table**.

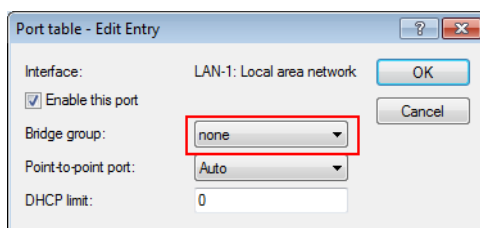

#### Port settings for Public Spot APs

- For the guest Internet access, create an entry in the list of DSL remote sites with the hold time '9999' and the pre-defined layer 'DHCPOE '. This example assumes that Internet access is provided by a router with DHCP server.

In LANconfig you find this setting under **Configuration > Communications > Remote sites > Remote sites (DSL)**.

Remote sites (DSL) - Edit Entry

Name: INTERNET

Short hold time: 9.999 seconds

Access concentrator:

Service:

Layer name: DHCPOE

MAC address type: Local

MAC address:

DSL ports: Select

VLAN ID: 0

Remote site for Internet access

8. For internal users, create the IP network 'INTRANET' with (for example) the IP address '192.168.1.100' and the interface tag '1'. For the guest access, create the IP network 'GUEST-ACCESS' with (for example) the IP address of '192.168.200.1' and the interface tag '2'. The virtual router in the WLAN controller uses the interface tags to separate the routes for the two networks. In LANconfig you find this setting under **Configuration > TCP- > IP > General > IP networks**.

IP networks - Edit Entry

Network name: INTRANET

IP address: 192.168.1.100

Netmask: 255.255.255.0

Network type: Intranet

VLAN ID: 0

Interface assignment: Any

Address check: Loose

Interface tag: 1

Comment:

IP network for internal use

IP networks - Edit Entry

Network name: GUEST

IP address: 192.168.200.1

Netmask: 255.255.255.0

Network type: Intranet

VLAN ID: 0

Interface assignment: Any

Address check: Loose

Interface tag: 2

Comment:

IP network for guest access

9. The WLAN controller can act as a DHCP server for access points and the associated WLAN clients. To set this up, activate the DHCP server for the 'INTRANET' and the 'GUEST-ACCESS'. In LANconfig you find this setting under **Configuration > TCP > DHCP > DHCP networks**.



- ! Activation of the DHCP server is obligatory for the guest network and optional for the internal network. There are other ways of realizing a DHCP server for the internal network.

DHCP networks - Edit Entry

Network name: GUEST

DHCP server enabled: Yes

Evaluate broadcast bit

DHCP cluster

DHCP network for guest access

10. Create a new default route in the routing table to direct the data from the guest network to the Internet connection used by the WLAN controller. Select the routing tag '2' and the router 'Internet'. Also activate the option 'Masking intranet and DMZ (default)'. In LANconfig you find this setting under **Configuration > IP router > Routing > Routing table**.

Routing table - Edit Entry

IP address: 255.255.255.255

Netmask: 0.0.0.0

Routing tag: 2

Enable state:

Route is enabled and will always be propagated via RIP (sticky)

Route is enabled and will be propagated via RIP if the target network is reachable (conditional)

This route is disabled

Router: INTERNET

Distance: 0

IP masquerading:

masking Intranet and DMZ (default)

IP Masquerading switched off

masking Intranet only

Comment: Internetzugang nur fuer

Routing entry for Internet access

11. Activate the Public Spot user authentication for the logical LAN interface 'WLC-Tunnel-1'. In LANconfig you find this setting under **Configuration > Public Spot > Public Spot**.

Interfaces - Edit Entry

Interface: WLC-TUNNEL-1

User Authentication enabled

Activation of user authentication for the WLC tunnel

12. The final step is to enable authentication via the Public Spot for the WLAN controller. In LANconfig you find this setting under **Configuration > Public Spot > Authentication**.

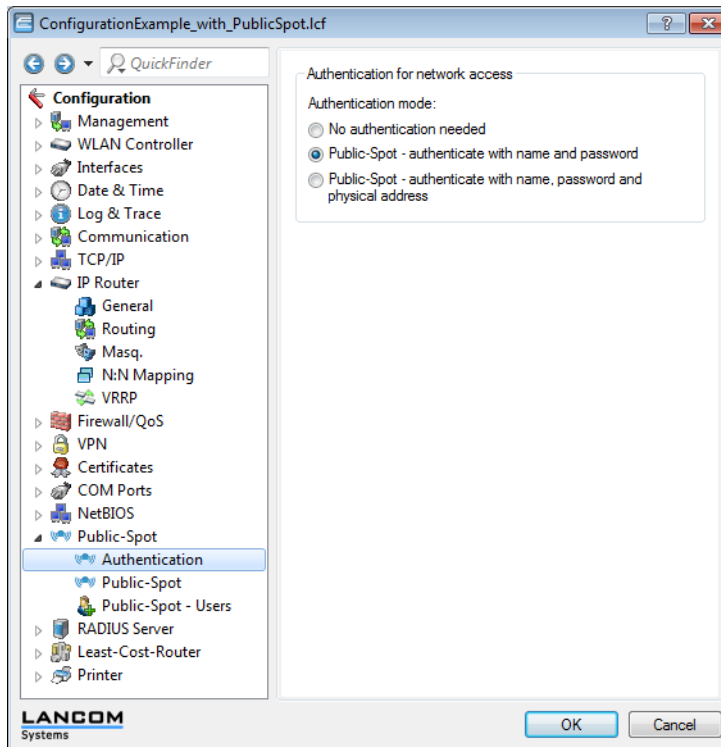

#### Activation of authentication via Public Spot

In addition to configuring the WLAN controller, you must also configure the Public Spot either to use the internal user list or to use a RADIUS server, according to your needs.

- ! An example for the configuration of the Public Spot can be found in the tutorial [Virtualization and guest access accounts via the LANCOM WLAN controller](#).

## 13.8.8 RADIUS

### Checking WLAN clients with RADIUS (MAC filter)

To use RADIUS to authenticate WLAN clients and grant them WLAN access based on their MAC address, an external RADIUS server can be used, as can the internal user table in the LANCOM WLAN controller.

In LANconfig enter the approved MAC addresses into the RADIUS database in the configuration section **RADIUS servers** on the **General** tab. Enter the MAC address as **Name** and as **Password** and select the authentication method **All**.

Alternatively, the approved MAC addresses can be entered in WEBconfig under **LCOS menu tree > Setup > RADIUS > Server > Users**.

! The MAC address is entered as **User name** and as **Password** in the written form 'AABBCC-DDEEFF'.

## External RADIUS server

By default the WLAN controller forwards any requests relating to the account and access management to a RADIUS server. In order for access points to contact the RADIUS server directly, the necessary server information has to be defined here. This ensures that the RADIUS application continues to function even if the WLAN controller is unavailable. However, this means that the RADIUS server requires settings for each and every access point, and the managed access points

must be able to access the RADIUS server from their management network. If the RADIUS server is on another IP network, then it is vital that the gateway is set in the IP parameter profile.

LANconfig: **WLAN Controller > Stations > RADIUS server**

WEBconfig: **LCOS Menu Tree > Setup > WLAN Management > RADIUS-Server**

- **Type:** Type of RADIUS application.

**Possible values:**

Account or access

**Default:**

The entries account, access, backup account and backup access are fixed settings that cannot be changed.

- **IP address:** IP address to be used by the AP in order for it to reach the RADIUS server. If no value is entered the controller's IP address is taken as default.

**Possible values:**

Valid IP address.

**Default:**

Blank

- **Port:** Port number of the RADIUS server that is communicated to the AP in order for it to reach the RADIUS server. The port must agree with the value configured in the RADIUS server. This value will be ignored if no IP address is configured as the controller itself will be used as the RADIUS server.

**Possible values:**

Valid port number, generally 1812 for access management and 1813 for account management.

**Default:**

0

- **Secret:** Password for the RADIUS service. The key (secret) must agree with the value configured in the RADIUS server. This value will be ignored if no IP address is configured as the controller itself will be used as the RADIUS server.

**Possible values:**

Maximum 31 ASCII characters.

**Default:**

Blank

### 13.8.9 Dynamic VLAN assignment

Larger WLAN infrastructures often require individual WLAN clients to be assigned to certain networks. Assuming that the WLAN clients are always within range of the same access points, then assignment can be realized via the SSID in connection with a particular IP network. If on the other hand the WLAN clients frequently change their position and logon to different access points then, depending on the configuration, they may find themselves in a different IP network.

For WLAN clients to remain within a certain network **independent** of their current WLAN network, dynamically assigned VLANs can be used. Unlike the situation where VLAN IDs are statically configured for a certain SSID, in this case a RADIUS server directly assigns the VLAN ID to the WLAN client.

**Example:**

- The WLAN clients of two employees log into an access point in the WPA-secured network with the SSID 'INTERNAL'. During registration, the RADIUS requests from the WLAN clients are directed to the access point. If the corresponding WLAN interface is in the operating mode 'managed' the RADIUS requests are automatically forwarded to the WLAN controller. This forwards the request in turn to the defined RADIUS server. The RADIUS server can check the access rights of the WLAN clients. It can also use the MAC address to assign a certain VLAN ID, for example for a certain department. The WLAN client in Marketing, for example, receives the VLAN ID '10' and WLAN client from Research & Development receives '20'. If no VLAN ID is specified for the user, the SSID's primary VLAN ID is used.
- The WLAN clients of the guests log into the same access point in the unsecured network with the SSID 'PUBLIC'. This SSID is statically bound to the VLAN ID '99' and leads the guests into a certain network. Static and dynamic VLAN assignment can be elegantly operated in parallel.

! Assignment of the VLAN ID by the RADIUS server can be controlled by other criteria, such as a combination of user name and password, for example. In this way the unknown MAC address of a visitor to a company can be assigned a VLAN ID that permits guest access for Internet access only, for example, but that prohibits access to other network resources.

! As an alternative to an external RADIUS server, WLAN clients can be assigned with a VLAN ID via the internal RADIUS server or the stations table in the LANCOM WLAN controller.

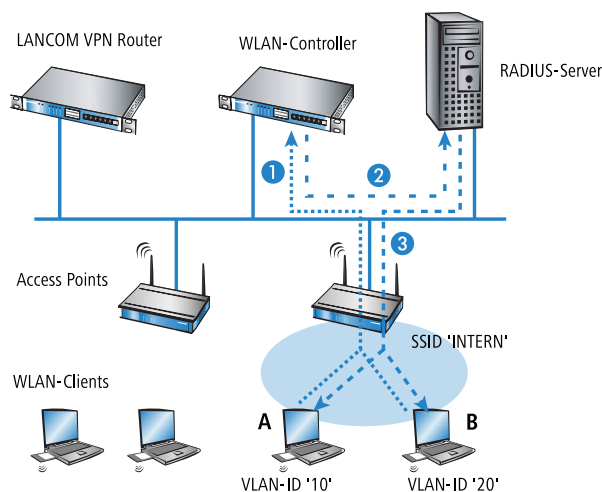

1. Activate VLAN tagging for the WLAN controller. This is done in the physical parameters of the profile by entering a value greater than '0' for the management VLAN ID.
2. For authentication via 802.1x, go to the encryption settings for the profile's logical WLAN network and choose a setting that triggers an authentication request.
3. To check the MAC addresses, activate the MAC check for the profile's logical WLAN network.

! For the management of WLAN modules with a WLAN controller, a RADIUS server is required to operate authentication via 802.1x and MAC-address checks. The WLAN controller automatically defines itself as the RADIUS server in the access points that it is managing—all RADIUS requests sent to the access points are then directly forwarded to the WLAN controller, which can either process the requests itself or forward them to an external RADIUS server.

4. To forward RADIUS requests to another RADIUS server, use LANconfig to enter its address into the list of forwarding servers in the configuration section 'RADIUS servers' on the **Forwarding** tab. Alternatively, external RADIUS servers can be entered in WEBconfig under **LCOS menu tree > Setup > RADIUS > Server > Forward server**. Also, set

the standard realm and the empty realm to be able to react to different types of user information (with an unknown realm, or even without a realm).

5. Configure the entries in the RADIUS server so that WLAN clients placing requests will be assigned the appropriate VLAN IDs as based on the identification of certain characteristics.

! Further information about RADIUS is available in the documentation for your RADIUS server.

### 13.8.10 Activating 802.1x accounting for logical WLANs in WLAN controllers

The configuration for logical WLAN networks is to be found in the following menu:

LANconfig: **WLAN Controller > Profiles > Logical WLAN networks (SSIDs)**

WEBconfig: **LCOS Menu Tree > Setup > WLAN-Management > AP-Configuration > Network profiles**

#### ■ RADIUS accounting activated

This is where you can activate RADIUS accounting for this logical WLAN network.

Possible values:

- Yes, No

Default:

- No

! The access points supporting the logical WLAN network as configured by the WLAN controller must have an LCOS version 8.00 or higher.

### 13.8.11 Displays and commands in LANmonitor

LANmonitor gives you a rapid overview of the LANCOM WLAN controllers in your network and the access points within the WLAN infrastructure. LANmonitor displays the following information, among others:

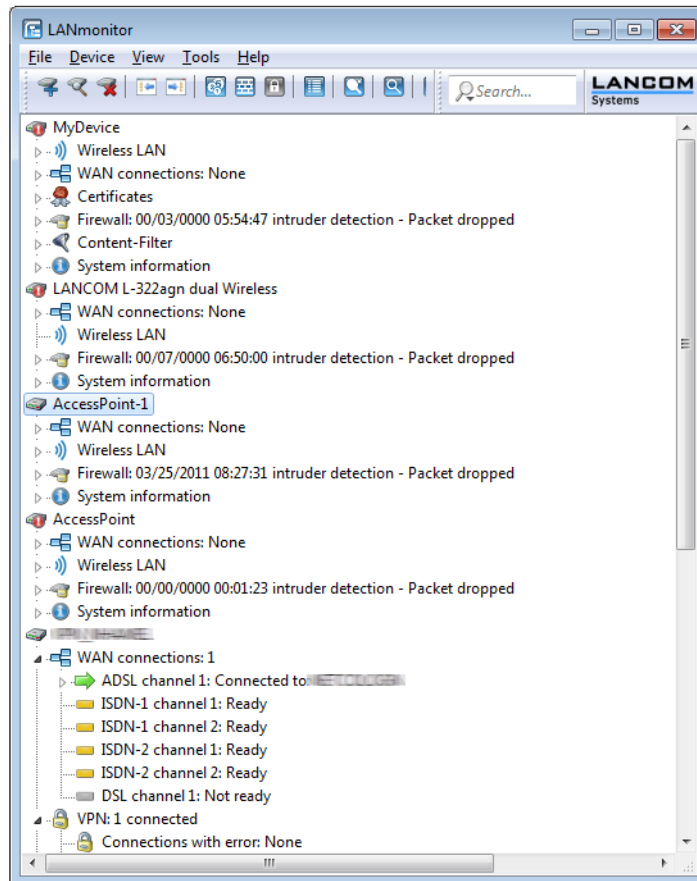

- Active WLAN networks with the logged-on WLAN clients and the descriptor of the access point that the WLAN clients are associated with.
- Display of new access points with IP and MAC address
- Display of missing access points with IP and MAC address
- Display of managed access points with IP and MAC address, the utilized frequency band and channel

Using the right-hand mouse key, a context menu can be opened for the access points and the following commands are available:

- **Assign new access point to profile**  
Enables a new access point to be allocated to a profile and accepted into the WLAN infrastructure.
- **Disconnect access point**  
Disconnects the access point from the WLAN controller. The access point then carries out a new search for a suitable WLAN controller. This command can be used after a backup event to disconnect access points from a backup controller and to redirect them to the correct WLAN controller.
- **Refresh**  
Updates LANmonitor's display.

### 13.8.12 Automatic RF optimization

Selecting the channel from the channel list defines a portion of the frequency band to be used by an access point for its logical wireless LANs. The WLAN clients connected to an access point have to share the same channel on the same frequency band. The 2.4-GHz band works with channels 1 to 13 (depending on the country) and the 5-GHz band works with channels 36 to 64. On each of these channels, only one access point at a time can actually transfer data. In order to operate another access point within radio range with maximum bandwidth, each access point must use a separate channel—otherwise all of the participating WLANs would have to share a single channel's bandwidth.

! With a completely empty channel list, the access points could automatically select channels which overlap in some areas, so reducing signal quality. Similarly, the access points might select channels which the WLAN clients cannot use due to the country settings. To steer access points towards certain channels, the non-overlapping channels 1, 6, 11 can be activated in the channels list.

In larger installations with several access points it can be difficult to set a channel for every access point. With automatic radio-field (RF) optimization, the LANCOM WLAN controllers provide an automatic method of setting the optimum channels for access points that work in the 2.4-GHz band and 5-GHz band.

! You should ensure that access points transmitting in the 5-GHz band are set to the "indoor only" mode.

WEBconfig: **Setup > WLAN-Management > Start-automatic-radio-field-optimization**

! You can invoke optimization for a particular access point by entering its MAC address as a parameter for the action.

LANmonitor: Right-click on the list of active access points or on a specific device, and in the context menu select **Start automatic RF optimization**.

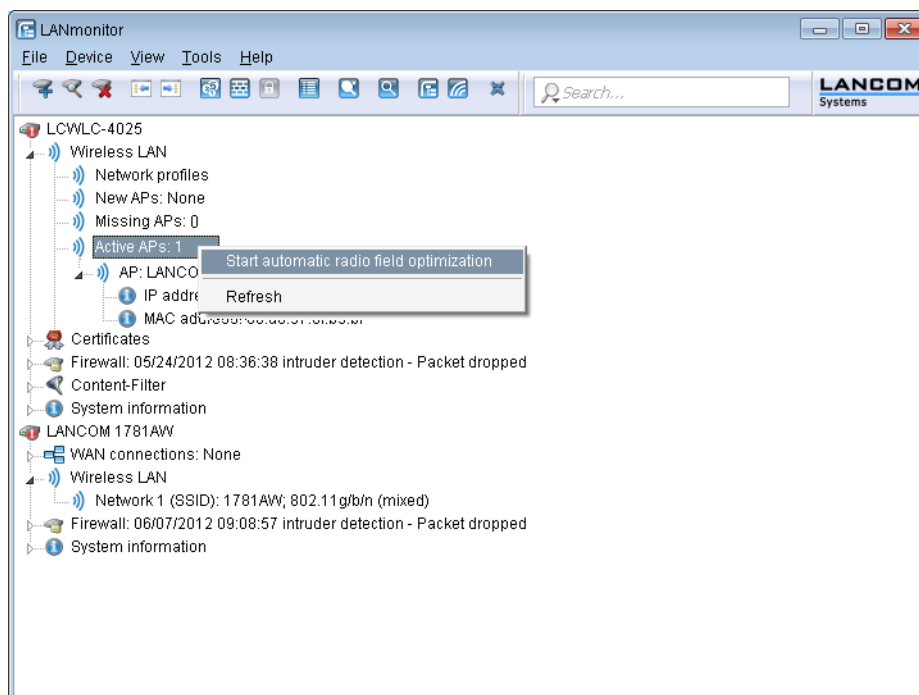

Optimization is then carried out in the following stages:

1. The WLAN controller assigns the same channel to all access points. The selected channel is the one being used by the majority of access points.
2. The access points carry out a background scan and report the results to the WLAN controller.



3. Based on the devices found by the background scan, the WLAN controller sets an interference value for each access point.
4. It then deletes the AP channel list for all access points. With the channel list now empty, each access point receives a configuration update with a new channel list for its respective profile.
5. The WLAN controller disables the radio modules of all access points.
6. The individual access points now go through the following sequence. This begins with the access point with the highest interference value being the first to select a channel.
7. In the order of the interference values the WLAN controller enables the radio modules in the access points, which then start their automatic calibration. Each access point automatically searches for the best channel from the channel list assigned to it. To determine which channel is the best, the access point scans for interference to determine the signal strengths and channels occupied by other access points. Because the former list in the WLAN controller's configuration was deleted, this is now the profile channel list. If the profile channel list is empty, then the access point has freedom of choice from the channels that are not occupied by other radio modules. The selected channel is then communicated back to the WLAN controller and entered into the AP channel list there. This means that the access point is given the same channel the next time it establishes a connection. The AP channel list has a higher weighting than the profile channel list.

! If an access point has multiple radio modules, each module goes through this process in succession.

### 13.8.13 Channel-load display in WLC mode

The loads on the various channels used by each access point which is managed by a WLAN Controller are displayed as three values, the minimum, maximum and average channel load. The values displayed are measured every three minutes. Consequently, the first values are displayed after three minutes at the earliest.

The screenshot displays the WLANmonitor application window. The interface is divided into several sections:

- Groups:** A tree view on the left showing the hierarchy: WLANmonitor > Access Points (24) > WLAN-Controller > Aachen (2) > London (2) > Munich (3) > Rogue AP Detectio.
- Controller:** A table showing controller status.
 

Name	New ...	Missing APs	Active APs	Clients	IP-A
LC_BKP_WLC-4...	0	0	3	5	
LC_WLC-4025+	0	0	13	29	
- Network Profiles:** A list of network profiles with their names.
- Access Points:** A table showing channel load data for various access points.
 

Name	Interfa...	Clie...	Band	C...	Min. Chan...	Max. Chan...	Ave. Channel load
Ic-e280-OAP54	WLAN-2	2	5 GHz	64	0 %	2 %	1 %
Ic-e203-L322	WLAN-1	0	2,4 GHz	12	0 %	29 %	28 %
Ic-e203-L322	WLAN-2	1	5 GHz	100	0 %	0 %	0 %
Ic-e360-L322	WLAN-1	1	2,4 GHz	1	0 %	29 %	19 %
Ic-e360-L322	WLAN-2	0	5 GHz	64	0 %	2 %	0 %
L54-MPlum-H...	WLAN-1	0	5 GHz	108	0 %	0 %	0 %
L320agn-MPI...	WLAN-1	0	5 GHz	100	0 %	0 %	0 %
OAP310agn-...	WLAN-1	0	2,4 GHz	6	0 %	1 %	0 %
- Clients:** A table showing client status and channel load.
 

MAC Address	Identification	Sig...	Controller	Access Point	Network Profile
[MAC]	[ID]	18 %	LC_WLC-4025+	Ic-e202-L54dual	[Profile]
[MAC]	[ID]	31 %	LC_WLC-4025+	Ic-e202-L54dual	[Profile]
[MAC]	[ID]	45 %	LC_WLC-4025+	Ic-e203-L315	[Profile]
[MAC]	[ID]	35 %	LC_BKP_WLC-4025_	Ic-e203-L322	[Profile]
[MAC]	[ID]	75 %	LC_WLC-4025+	Ic-e213-XAP	[Profile]
[MAC]	[ID]	56 %	LC_WLC-4025+	Ic-e213-XAP	[Profile]
[MAC]	[ID]	25 %	LC_WLC-4025+	Ic-e213-XAP	[Profile]

### 13.8.14 Backing up the certificates

At system startup, a LANCOM WLAN controller generates the basic certificates for the assignment of certificates to the access points, including the root certificates for the CA (Certification Authority) and the RA (Registration Authority). Based on these two certificates, the WLAN controller issues device certificates for the access points.

If multiple WLAN controllers are employed in parallel in the same WLAN infrastructure (for load balancing) or if a device is being replaced or reconfigured, the same root certificates should always be used to avoid problems with the operation of the managed access points.

#### Create backups of the certificates

To restore the CA or RA, the corresponding root certificates with private keys will be required as were generated automatically when the LANCOM WLAN controller was started. Furthermore the following files with information on issued device certificates should also be backed up. To ensure that this confidential information remains protected even when exported from the device, it is initially stored to a password-protected PKCS12 container.

1. Open the configuration of the LANCOM WLAN controller in WEBconfig and go to **LCOS Menu Tree > Setup > Certificates > SCEP-CA > CA-certificates**.
2. Select the command **Create PKCS12 backup files** and enter the passphrase for the PKCS12 container as the additional argument.

**Create-PKCS12-Backup-Files**

Enter here any additional arguments for the command you are about to execute:

Arguments | Passphrase

This command backs up the certificates and private keys to the PKCS12 files and these can then be downloaded from the device.

#### Uploading a certificate backup into the device

1. Click on **File management > Upload certificate or file**.
2. Select the two entries for SCEP-CA as data type one after the other:
  - PKCS12 container with CA backup
  - PKCS12 container with RA backup
3. For each upload, enter the file name, storage location, and the passphrase that was defined when the backup file was created. Confirm with **Start upload**:

**Upload Certificate or File**

Select which file you want to upload, and its name/location, then click on 'Start Upload'.  
In case of PKCS12 files, a passphrase may be necessary.

File Type: SCEP-CA - PKCS12 container with CA backup

File Name/Location:  Browse...

Passphrase (if required):

Caution: Files are not being checked for correct contents or passphrase during upload. These checks are performed by the individual modules using these files. When uploading certificates, possible error messages can be seen in the VPN status trace immediately after download.

4. After loading the CA backup, the file `controller_rootcert` in the directory **Status > File-System > Contents** must be deleted.

Enter the following commands in the console:

```
cd /Status/File-System/Contents
del controller_rootcert
```

- After restoring the backup, delete all files that start with `controller_` or `eaptls_`.

```
del controller_*
del eaptls_*
```

- After that, access the directory **Setup > Certificates > SCEP-Client** and execute the command `Reinit`:

```
cd /Setup/Certificates/SCEP-Client
do Reinit
```

## Backing up and restoring further files from the SCEP-CA

To be able to fully restore the SCEP-CA, it is important to have the information on the device certificates issued for the individual access points by the SCEP-CA.

 If the root certificates only were backed up, then any issued device certificates can no longer be revoked!

For this reason the following files have to be saved in addition to the certificates themselves:

- SCEP certificate list: List of all certificates ever issued by the SCEP-CA.
- SCEP serial numbers: Contains the serial number for the next certificate.

- Click on **File management > Download certificate or file**.
- Select the entries listed above as data type one after the other and then confirm with **Start download**:



- To upload these files to the device, go to the entry page of WEBconfig and select the command **Upload certificate or file**.
- Select the entries listed above as data type one after the other, enter each file name and storage location and confirm with **Start upload**:

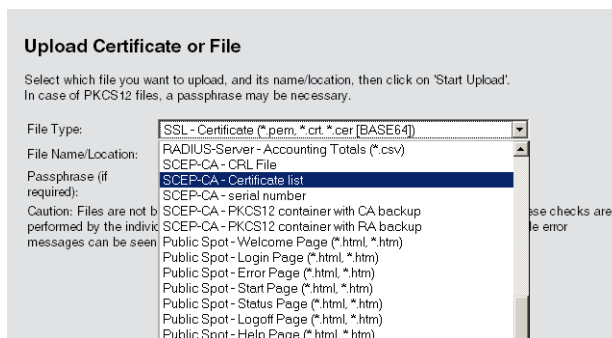

 After installing a new certificate list, expired certificates are removed and a new CRL is created. Furthermore, the CA reinitializes itself automatically if certificates and keys are successfully extracted after loading the certificate backup.

## 13.8.15 Backup solutions

LANCOM WLAN controllers manage a large number of access points, which in turn may have a large number of WLAN clients associated with them. WLAN controllers thus play a crucial role in the functioning of the entire WLAN infrastructure—for which reason the organization of a backup solution in case of temporary WLAN controller failure is in many cases indispensable.

In case of a backup event, a managed access point should connect to an alternative WLAN controller. Because this connection will only function if the certificate in the access point has been authorized by the backup controller, it is essential that all WLAN controllers sharing a backup solution have identical root certificates.

### Backup with redundant WLAN controllers

This is worthwhile for backing up a LANCOM WLAN controller with a second WLAN controller, the aim being to maintain full control over all managed access points at all times. The backup Controller is configured in such a way that it uses SCEP to obtain the necessary certificates from the backed-up primary WLAN controller.

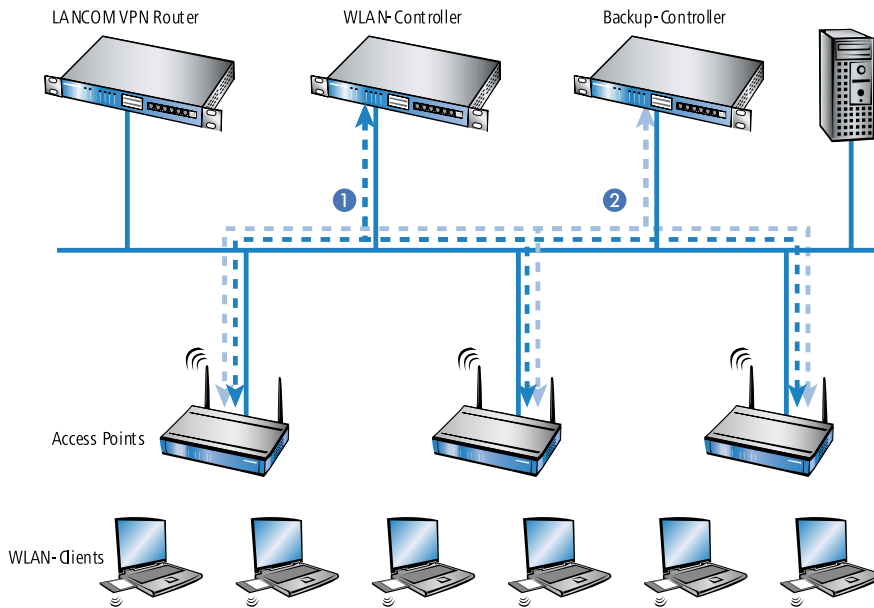

- 1.
2. Switch off the CA on the backup Controller.
3. In the configuration of the SCEP client in the backup controller, create a new backup in the CA table (in LANconfig under **Certificates > SCEP client > CA table**). The CA of the primary WLAN controller is entered here:

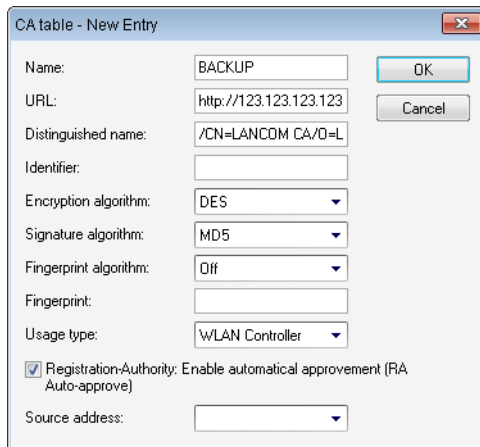

4. The URL is to be entered as the IP address or the DNS name of the primary WLAN controller followed by the path to the CA `/cgi-bin/pkiclient.exe`. For example `10.1.1.99/cgi-bin/pkiclient.exe`.
  - **Distinguished name:** Standard name of the CA (`/CN=LANCOM CA/O=LANCOM SYSTEMS/C=DE`) or the name given on the primary Controller
  - Switch on **RA auto approve**
  - **Usage type:** WLAN controller

5. Then create a new entry in the certificate table with the following information:

- **CA distinguished name:** The standard name under which the CA is entered, e.g. /CN=LANCOM CA/O=LANCOM SYSTEMS/C=DE
  - **Subject:** Specification of the primary WLAN controller's MAC address in the form: /CN=00:a0:57:01:23:45/O=LANCOM SYSTEMS/C=DE
  - **Challenge password:** The general challenge password of the CA on the primary WLAN controller or a password for the Controller specified manually.
  - **Extended key usage:** critical,serverAuth,1.3.6.1.5.5.7.3.18
  - **Key length:** 2048 bits
  - **Usage type:** WLAN controller
6. If a SCEP configuration was previously active on the backup controller, the following actions must be executed under WEBconfig (**LCOS Menu Tree > Setup > Certificates > SCEP client**):
- Clear SCEP file system
  - Update (2x: the first time, the SCEP client retrieves the new CA/RA certificates only; the second time the device certificate is updated)
7. Configure the first WLAN controller **1** according to your requirements with all profiles and the associated AT table. The access points then establish connections to the first WLAN controller. Each access point receives a valid certificate and a configuration for the WLAN module from the WLAN controller.
8. Transfer the configuration from the first WLAN controller **1**, for example using LANconfig, to the backup controller **2**. The profiles and the AP tables with the access point MAC addresses are transferred to the backup controller at the same time. All access points remain logged on to the first WLAN controller.

Should WLAN controller **1** fail, the access points will automatically search for another WLAN controller and they will find the backup controller **2**. Because this has the same root certificate, it is able to check the validity of the access points' certificates. Because the access points are also entered into the backup controller's AP table along with their MAC addresses, the backup controller can fully take over the management of the access points. Changes to the WLAN profiles in the backup controller will directly affect the managed access points.

ⓘ In this scenario, the access points remain under the management of the backup controller until this itself becomes unavailable or is manually disconnected.

ⓘ If the access points are set up for standalone operation, they will remain operational while searching for a backup controller and the WLAN clients will remain associated.

### Backup with primary and secondary WLAN controllers

This second type of backup you can provide a larger number of "primary" WLAN controllers with one common "secondary" backup controller. In case a WLAN controller should fail, the access points remain operational but they work with the current configuration of the WLAN modules. As a secondary controller, the backup controller cannot assign any configuration changes to the access points.

## Primary and secondary controllers

Connection establishment between an access point and the WLAN controller is always initiated by the access point. A LANCOM access point in managed mode will search the LAN for a WLAN controller that will provide the configuration. During this search the access point may find various suitable WLAN controllers:

- The WLAN controller can authenticate the **certificate** in the access point and it has a **configuration** stored for the access point's MAC address. A WLAN controller of this type is described as a "primary" WLAN controller.
- A WLAN controller can authenticate the **certificate** of an access point, but it has **neither a configuration** stored for the MAC address of the access point, **nor does it have a default configuration**. A WLAN controller of this type is described as a "secondary" WLAN controller.

This is an example of a backup solution with three WLAN controllers for 50 managed access points: Two of the WLAN controllers each manage 25 access points and the third is available as a backup:

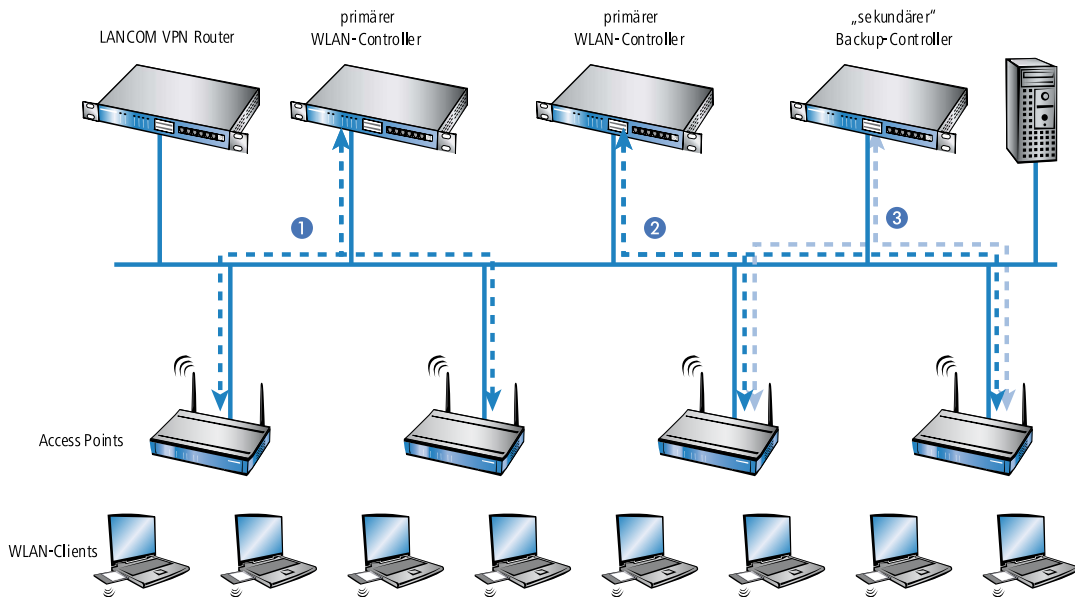

ⓘ A LANCOM WLAN controller is now able to accommodate in its AP table five times the maximum number of access points that it can manage by itself. For each five WLAN controllers (identical models), just one additional WLAN controller is sufficient to provide a full backup in case of failure.

1. Set the same time on all of the WLAN controllers **1**, **2** and **3**.
2. Transfer the CA and RA certificates from the first primary WLAN controller **1** to the second primary **2** and to the secondary "backup controller" **3**.
3. Configure the first WLAN controller **1** according to your requirements with the profiles and the associated AP table for one half of the access points. This WLAN controller becomes the primary controller for the access points entered into it.

ⓘ For a backup solution using a secondary WLAN controller, be sure to set the time for standalone operations such that the access point has time to find a backup controller. This is because the backup controller is not able to provide a new configuration for the access point.

Once the access point has established a backup connection to a secondary WLAN controller, the countdown until expiry of standalone operation is halted. The access point and its WLAN networks remain active as long as it has a connection to a WLAN controller.

1. Configure the second WLAN controller **2** for the other half of the access points, which subsequently treat this WLAN controller as their primary controller.
2. For the backup controller **3** the time and the root certificates are set up only. No further configuration is required.

3. After being started, the access points search for a WLAN controller by emitting a discovery message. In this case, all three LANCOM WLAN controllers respond to this message—the access points select "their" primary controller for the DTLS connection that follows. One half of the access points decides on WLAN controller **1** and the other half chooses WLAN controller **2**. Because WLAN controller **3** does not function as primary controller for any of the access points, none of the access points log on to it.
4. Should WLAN controller **2** fail, the access points will automatically search for another WLAN controller. They discover the WLAN controllers **1** and **3**, whereby **1** is already under full load with its 25 access points. Backup controller **3** is able to check the validity of the certificates, i.e. it can authenticate the access points and accept them as managed access points. However, because the access points are **not** entered with their MAC numbers into the backup controller's AP table, the backup controller cannot manage the access points any longer; they simply continue to operate with their current WLAN configurations.

---

 If WLAN controller **1** is not under full load, for example because some of "its" access points are switched off, then some of the searching access points could log on here. WLAN controller **1** remains a "secondary" controller for these access points because it does not have their configuration profiles. If in this situation one of the access points with an entry in the AP table of WLAN controller **1** is switched on again, then **1** accepts this reactivated access point and, in exchange, it disconnects one of the backup-event access points.

---

 If the access points are set up for standalone operation they will remain operational while searching for a backup controller, and the WLAN clients can continue to use all of their functions.

## 13.8.16 Addition(s) to LCOS 8.82

### Band steering via WLAN controller

As of LCOS version 8.82, WLAN controllers can manage settings for band steering for the access points in the radio profiles.

### Enhancements to LANconfig

#### Configuration

Most of the parameters for configuring the LANCOM WLAN controller correspond with those of the access points. For this reason, this section does not explicitly describe all of the WLAN parameters, but only those aspects necessary for operating the WLAN controller.

#### Profiles

The profiles area is used to define the logical WLAN networks, physical WLAN parameters, and the WLAN profiles which combine these two elements.

Logical WLAN networks

Here the logical WLAN networks are set for assignment to the access points. The following parameters can be defined for each logical WLAN network:

LANconfig: **WLAN controller > Profiles > Logical WLAN networks**

WEBconfig: **LCOS Menu Tree > Setup > WLAN-Management > AP-Configuration > Network profiles**

- **Network name (SSID)**

Name of the logical WLAN network under which the settings are saved. This name is only used for internal administration of logical networks.

- **Inheritance**

Selection of a logical WLAN network defined earlier and from which the settings are to be inherited.

- **SSID connect to**

Service Set Identifier – the name under which the logical WLAN network is offered to the WLAN clients.

- **VLAN-ID**

VLAN ID for this logical WLAN network

ⓘ Please note that to use VLAN IDs in a logical WLAN network, you must set up a management VLAN ID (see physical WLAN parameters).

- **AP standalone time**

The time in minutes that a managed-mode access point continues to operate in its current configuration.

The configuration is provided to the access point by the WLAN controller and is optionally stored in flash memory (in an area that is not accessible to LANconfig or other tools). Should the connection to the WLAN controller be interrupted, the access point will continue to operate with the configuration stored in flash for the time period entered here. The access point can also continue to work with this flash configuration after a local power outage.

If there is still no connection to the WLAN controller after this time period has expired then the flash configuration is deleted and the access point goes out of operation. As soon as the WLAN controller is available again, the configuration is transmitted again from the WLAN controller to the access point.

This option enables an access point to continue operating even if the connection to the WLAN controller is temporarily interrupted. Furthermore this represents an effective measure against theft as all security-related configuration parameters are automatically deleted after this time has expired.



! If the access point establishes a backup connection to a secondary WLAN controller, then the countdown to the expiry of standalone operation is halted. The access point and its WLAN networks remain active as long as it has a connection to a WLAN controller.

! Please note that the configuration in flash memory is deleted only after expiry of the time for standalone operation, and not when the power is lost!

#### ■ Minimum client signal strength

This entry determines the threshold, in percentage, for the minimum signal strength for clients when logging on. If the client's signal strength is below this value, the access point stops sending probe responses and discards the client's requests.

A client with poor signal strength will not detect the access point and cannot associate with it. This ensures that the client has an optimized list of available access points, since the list does not contain any access points that would offer a weak connection at the client's current position.

! All other WLAN network parameters correspond to those for the standard configuration of access points.

### Physical WLAN parameters

Here the physical WLAN parameters are set for assignment to the access points. The following parameters can be defined for each set of physical WLAN parameters:

LANconfig: **WLAN Controller > Profiles > Physical WLAN parameters**

WEBconfig: **LCOS Menu Tree > Setup > WLAN management > AP configuration > Radio profiles**

#### ■ Name

Unique name for this combination of physical WLAN parameters.

#### ■ Inheritance

Selection of a physical WLAN parameter set defined earlier and from which the settings are to be inherited.

#### ■ Country

The country in which the access points are to be operated. This information is used to define country-specific settings such as the permitted channels, etc.

#### ■ Automatic channel selection

By default, the access points can use all of the channels permitted in the country of operation. To restrict the selection to certain channels, these can be entered here as a comma-separated list. It is also possible to specify ranges or lists (e.g. '1,6,11').

#### ■ Management VLAN-ID

The VLAN ID of the management network that is to manage the access points.

---

 The Management VLAN ID **must** be set to a value not equal to zero in order for VLANs to be used over the WLAN networks. This also applies when the management network itself is not to be tagged with VLAN IDs (Mgmt-VLANID=1).

---

 VLAN activation only applies to WLAN networks which are connected by means of these physical WLAN parameters.

■ **Band steering activated**

This entry determines whether the access point should enable band steering. In this case, a dual-port access point can forward a WLAN client to a preferred frequency band.

---

 All other physical WLAN parameters correspond to those for the standard configuration of access points.

---

 To successfully acquire a profile, HTTP access to the WLAN controller from the local network must be allowed.

### Additions to the Setup menu

#### Report seen clients

This entry determines whether the access point should report clients detected in the WLAN network.

**SNMP ID:**

2.37.1.2.20

**Telnet path:**

**Setup > WLAN-Management > AP-Configuration > Radioprofiles**

**Possible values:**

Yes

No

**Default:**

Yes

#### Client steering

This entry determines whether the access point should enable band steering.

**SNMP ID:**

2.37.1.2.21

**Telnet path:**

**Setup > WLAN-Management > AP-Configuration > Radioprofiles**

**Possible values:**

Yes

No

**Default:**

No

#### Preferred band

This entry determines the frequency band that the access point preferably should direct the WLAN client.

**SNMP ID:**

2.37.1.2.22

**Telnet path:****Setup > WLAN-Management > AP-Configuration > Radioprofiles****Possible values:**

5GHz

2.4GHz

**Default:**

5GHz

**Probe request ageout in seconds**

This entry determines the length of time in seconds that the access point should store a WLAN client's connection. When this time expires, the access point deletes the entry from the table.



This value should be set to a low value if you are using clients in the WLAN that frequently switch from dual-band to single-band mode.

**SNMP ID:**

2.37.1.2.23

**Telnet path:****Setup > WLAN-Management > AP-Configuration > Radioprofiles****Possible values:**

max. 10 characters from 0 to 9

**Special values:**

0: The access point immediately considers seen probe requests as invalid.

**Default:**

120

**Minimum client strength**

This entry determines the threshold, in percentage, for the minimum signal strength for clients when logging on. If the client's signal strength is below this value, the access point stops sending probe responses and discards the client's requests.

A client with poor signal strength will not detect the access point and cannot associate with it. This ensures that the client has an optimized list of available access points, since the list does not contain any access points that would offer a weak connection at the client's current position.

**SNMP ID:**

2.37.1.1.36

**Telnet path:****Setup > WLAN-Management > AP-Configuration > Network-Profiles****Possible values:**

max. 3 characters from 0 to 9

**Default:**

0

## 13.9 Central firmware and script management

LANCOM WLAN Controllers allow the configurations of multiple LANCOM Wireless Routers and LANCOM Access Points to be managed from a central location in a consistent and convenient manner. With central firmware and script management, uploads of firmware and scripts can be automated for all of the WLAN devices.

To achieve this, the firmware and script files are stored on a Web server (firmware as \*.upx files, scripts and \*.lcs files). The WLAN-Controller checks once daily, or on user request, to compare the available files with those on the devices. Alternatively, this procedure can be handled by a cron job—overnight, for example. If an update can be carried out, or if the Access Point is not running the desired firmware version, then the WLAN-Controller downloads the file from the Web server and uploads it to the appropriate Wireless Routers and Access Points.

The configuration of firmware and script management provides precise control over the distribution of the files. It is possible, for example, to limit certain firmware versions to certain device types or MAC addresses.

An update can be carried out in two possible states:

- When a connection is established; the Access Point subsequently restarts automatically.
- If the Access Point is already connected, the device does **not** restart automatically. In this case the Access Point is manually restarted with the menu action "/Setup/WLAN-Management/Central-Firmware-Management/Reboot-updated-APs" or by a timed cron job.
- The action "/Setup/WLAN-Management/Central-Firmware-Management/Update-Firmware-and-Script-Information" updates the script and firmware directories.

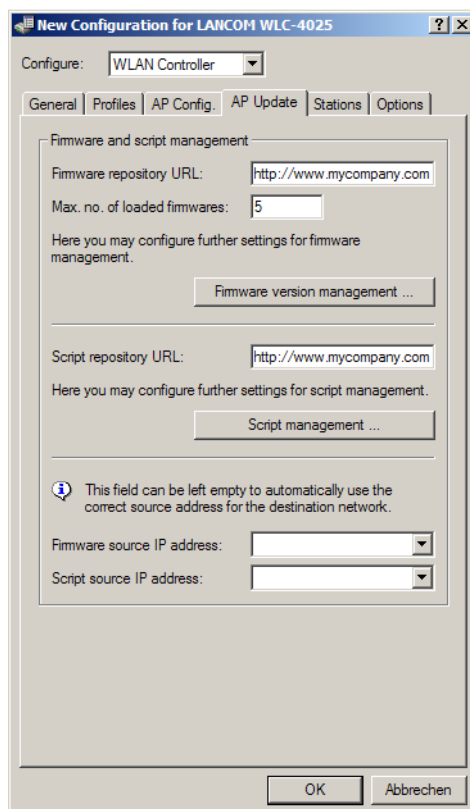

The parameters for configuration can be found under the following paths:

LANconfig: **WAN Controller / AP Update**

WEBconfig: **Setup / WLAN Management / Central Firmware Management**

### 13.9.1 General settings for firmware management

- Firmware URL

The path to the directory with the firmware files.

- Possible values: URL in the form `Server/Directory` or `http://Server/Directory`
- Default: Blank

- Simultaneously loaded FW

The number of firmware versions loaded simultaneously into the main memory of the WLAN-Controller.

---

 The firmware versions stored here are downloaded from the server just once and then used for all update processes.

- Possible values: 1 to 10
- Default: 5

- Firmware sender IP address

This is where you can configure an optional sender address for use instead of the one automatically selected for the destination address.

Possible values:

- Name of a defined IP network.
- 'INT' for the IP address in the first network with the setting 'Intranet'.
- 'DMZ' for the IP address in the first network with the setting 'DMZ'.
- Name of a loopback address.
- Any other IP address.

Default:

- Blank

---

 If the list of IP networks or loopback addresses contains an entry named 'INT' or 'DMZ', the associated IP address of the IP network or the loopback address named 'INT' or 'DMZ' is used.

### 13.9.2 Firmware management table

Table with device type, MAC address and firmware version for the precise control of the firmware files in use.

- Device types

Select here the type of device that the firmware version specified here is to be used for.

- Possible values: All, or a selection from the list of available devices.
- Default: All

- MAC address

Select here the device (identified by its MAC address) that the firmware version specified here is to be used for.

- Possible values: Valid MAC address
- Default: Blank

- Version

Firmware version that is to be used for the devices or device types specified here.

- Possible values: Firmware version in the form `x . xx`
- Default: Blank

### 13.9.3 General settings for script management

- Script URL

The path to the directory with the script files.

- Possible values: URL in the form `Server/Directory` or `http://Server/Directory`
- Default: Blank

- Script sender IP address

This is where you can configure an optional sender address for use instead of the one automatically selected for the destination address.

Possible values:

- Name of a defined IP network.
- 'INT' for the IP address in the first network with the setting 'Intranet'.
- 'DMZ' for the IP address in the first network with the setting 'DMZ'.
- Name of a loopback address.
- Any other IP address.

Default:

- Blank



If the list of IP networks or loopback addresses contains an entry named 'INT' or 'DMZ', the associated IP address of the IP network or the loopback address named 'INT' or 'DMZ' is used.

### 13.9.4 Script management table

Table with the name of the script file and a WLAN profile for allocating the script to a WLAN profile.

Configuring a Wireless Router and Access Point in the "Managed" mode is handled via WLAN profiles. A script can be used for setting those detailed parameters in managed devices that are not handled by the pre-defined parameters in a WLAN profile. Distribution is also handled by WLAN profiles to ensure that the Wireless Routers and Access Points with the same WLC configuration also use the same script.

As only one script file can be defined per WLAN profile, versioning is not possible here. However, when distributing a script to a Wireless Router or Access Point, an MD5 checksum of the script file is saved. This checksum allows the WLAN-Controller to determine whether the script file has to be transmitted again in case a new or altered script has the same file name.

- Script file name

Name of the script file to be used.

- Possible values: File name in the form `*.lcs`
- Default: Blank

- WLAN profile

Select here the WLAN profile that the script file specified here should be used for.

- Possible values: Selection from the list of defined WLAN profiles.
- Default: Blank

### 13.9.5 Internal script storage (script management without an HTTP server)

In contrast to firmware files, scripts involve only small volumes of data. The WLAN-Controller's internal script storage allows three scripts of up to 64KB each to be stored. If script requirements do not exceed this volume, an HTTP server does not need to be configured for this purpose.

Script files are simply loaded from the designated storage location using WEBconfig. After upload the list of available scripts must be updated with Configure/Wireless LAN/Central Firmware /Update Firmware and Script Information.

The internal scripts can be referenced from the script management table using the relevant names (WLC\_Script\_1.lcs, WLC\_Script\_2.lcs or WLC\_Script\_3.lcs).

 Please be careful with upper and lower case letters when entering script names.

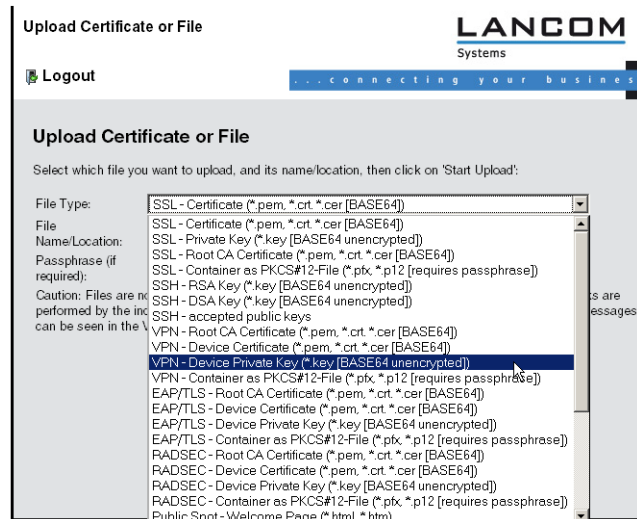
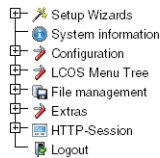

## 13.10 DFS 2: Non-use of channels for weather radar

With the DFS method (Dynamic Frequency Selection) as required for 5 GHz WLANs, an unused frequency is automatically selected, for example, to avoid interference from radar systems or to distribute WLAN devices as evenly as possible over the entire frequency band. Occasionally, however, signals from weather radar stations cannot be identified reliably.

For this reason the European Commission is extending the demands of standards ETSI EN 301 893 V1.3.1 and ETSI EN 310 893 V1.4.1 to additionally avoid the use of three channels (120, 124 and 128) in subband 2 of the 5 GHz band. These are not to be used for automatic channel selection. Methods for detecting weather radar signatures are currently under development.

## 13.11 Bandwidth limits in the WLAN

The bandwidths that are available can be limited so that they can be better distributed among several participants in the WLAN. This bandwidth limit is available for wireless ISPs, for example, who want to provide their customers with a defined bandwidth.

 Unlike bandwidth management using QoS (Quality of Service), this procedure does not allow a minimum bandwidth, but an exactly defined maximum bandwidth instead. Even if more bandwidth were actually available due to low traffic from other network stations, only the bandwidth specified here is provided to the user.

The settings differentiate between operating a device as an access point or in client mode.

### 13.11.1 Operating as an access point

In the access point operating mode, the maximum permitted bandwidths can be specified in Tx and Rx direction for the WLAN clients that register with the access point. The values of the maximum Tx and Rx bandwidths are entered in kbps in the MAC access list. A value of '0' indicates that there is no intention to restrict the bandwidth in this transmission direction. The bandwidth that is actually provided is determined from the value that is entered here and the value that is transmitted by the client.

**!** The significance of the Rx and Tx values depends on the device's operating mode. In this case, as an access point, Rx stands for "Send data" and Tx stands for "Receive data".

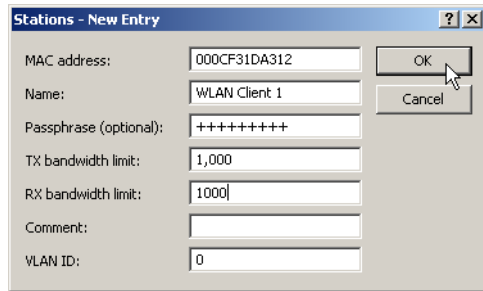

LANconfig: Wireless LAN / Stations

WEBconfig: LCOS menu tree / Setup / WLAN E Access list

### 13.11.2 Operating as a Client

If the device is operated as a WLAN client, the device can transmit its maximum bandwidth when it registers with the access point. The access point then provides the actual maximum bandwidths with proprietary limits for this client where necessary.

**!** The significance of the Rx and Tx values depends on the device's operating mode. In this case, as a client, Tx stands for "Send data" and Rx stands for "Receive data".

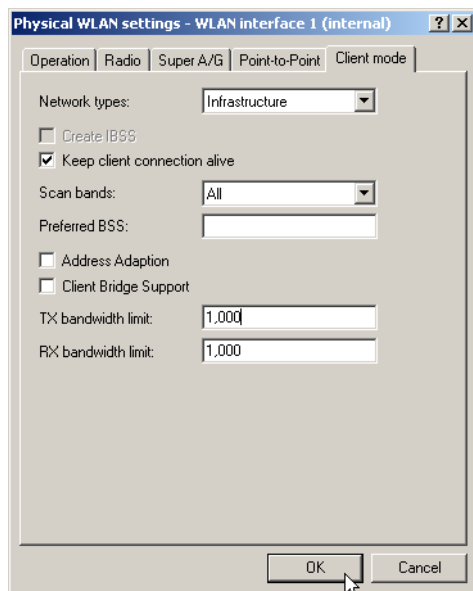

LANconfig: Interfaces / Wireless LAN / Physical WLAN Settings / Client Mode

WEBconfig: LCOS menu tree / Setup / Interfaces / WLAN/ Client modes

- Comment



Comment on this entry.

- VLAN ID

VLAN-ID for the WLAN client.

- Possible values: 0 to 4094
- Special values: 0: Switches the use of VLAN off.

## 13.12 Addition(s) to LCOS 7.70

### 13.12.1 APSD – Automatic Power Save Delivery

#### Introduction

Automatic Power Save Delivery (APSD) is an extension to the IEEE 802.11e standard. APSD is available in two versions:

- Unscheduled APSD (U-APSD)
- Scheduled APSD (S-APSD)

These two methods differ in the way that they use the transmission channels, among others. LANCOM access points and wireless routers support U-APSD, which forms the basis for the WiFi-certified WMM Power Save (WMMPS).

U-APSD allows WLAN devices to save considerable amounts of energy. This function has come into demand due to the increasing use of WLAN-capable telephones (Voice over WLAN – VoWLAN). Activating U-APSD for a wireless LAN enables WLAN devices making calls to switch into "doze mode" while they wait for the next data packet. Transmission of VoIP data takes place in a fixed time pattern—WLAN devices synchronize their phases of activity with this cycle, so that they are ready in good time to receive the next packet. This significantly reduces power consumption and the batteries provide a considerably longer call time.

The precise behavior of the power-saving mode is negotiated between the access point and WLAN client under consideration of the actual application at hand. This makes APSD much more flexible than former power saving methods, referred to in this context as "legacy power save".

#### Configuration

WEBconfig: LCOS menu tree / Setup / Interfaces / WLAN / Network

- APSD

Activates APSD power saving for this logical WLAN network.

Possible values:

- On, off

Default:

- Off



Please note that in order for the APSD function to work in a logical WLAN, QoS must be activated on the device. APSD uses mechanisms in QoS to optimize power consumption for the application.

#### Statistics

WEBconfig: LCOS menu tree / Status / WLAN E Networks

- APSD

Indicates whether APSD is activated or deactivated for the respective WLAN (SSID). APSD is only indicated as active if it is activated in the settings for the logical WLAN and also if the general QoS module is activated.

- WEBconfig: LCOS menu tree / Status / WLAN / Station table

Displays the access categories for which associated WLAN clients are using APSD:

- Voice (highest priority)
- Video
- Best effort (including data traffic from legacy power-save clients)
- Background (lowest priority).

### 13.12.2 BFWA – higher transmission power for longer ranges

BFWA stands for Broadband Fixed Wireless Access. A typical application would be to support a network node that provides Internet to subscribers connected to it. In Germany, the frequencies were provided as part of a general frequency allocation by the German Federal Network Agency. BFWA transmits at a frequency of 5.8 GHz. The maximum permitted transmission power for the operation of BFWA wireless bridges is 4000 mW EIRP (Equivalent Isotropic Radiated Power).

These high transmission powers are the advantage from BFWA. Without BFWA, the maximum permissible transmission power for outdoor WLAN directional radio systems in the 5-GHz band is limited to 1000 mW. This increases the legal transmission power to allow the same directional radio systems to function over significantly longer distances.

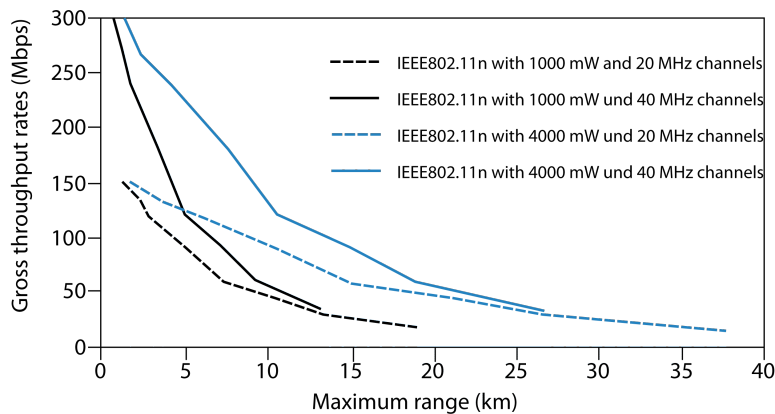

LANCOM access points based on 802.11n and all of the current LANCOM 54 Mbps access points support BFWA as of LCOS version 7.70. For older access points, support depends on the chipset (AR-5414 chipset). LANCOM Support can inform you whether these models are able to support BFWA.

For further information see the tech-paper "Broadband Fixed Wireless Access (BFWA)", available for download from [www.lancom.eu](http://www.lancom.eu).

## 13.13 Addition(s) to LCOS 7.80

### 13.13.1 ARF network for IAPP

Access points use the IAPP protocol to communicate and pass information about the handovers of associated WLAN clients which are roaming. Access points regularly send out multicast announcements to inform the devices about the BSSIDs and IP addresses of the other access points. A roaming WLAN client initiates a handover by informing a new access point about its former AP. The access point uses the information supplied by the IAPP protocol to inform the former access point to remove the WLAN client from its list of associated clients.

Where an access point supports multiple ARF networks, the IAPP announcements are transmitted on all ARF networks. To limit these multicasts to one particular ARF network, it is possible to define an IAPP IP network.

WEBconfig: LCOS menu tree / Setup / WLAN

- IAPP-IP network

Here you select the ARF network which is to be used as the IAPP-IP network.

Possible values:

- Selection from the list of ARF networks defined in the device; max. 16 alphanumerical characters

Default:

- Blank

Special values:

- Blank: If no IAPP-IP network is defined, IAPP announcements are transmitted on all of the defined ARF networks.

## 13.14 Addition(s) to LCOS 8.50

### 13.14.1 Alarm limits for WLAN devices

Typical situations that cause problems in the wireless LAN environment include a decrease in signal strength below a certain threshold, the percentage of lost packets exceeding a certain threshold, or packets frequently having to be resent—all of which can greatly reduce the available bandwidth.

In order to recognize and react to these situations, LANCOM Wireless devices now feature alarms to provide information on the over- or undershooting of threshold values.

 A connection is not absolutely rated as poor. The assessment always depends on the parameters that are specified. It should be noted that threshold limits that are too high or too low can lead to incorrect evaluation, and that a very large number of false alarms could be the result. A certain amount of packet loss and fluctuating signal strengths are to be expected even for stable wireless connections.

Threshold limits can be set for each individual SSID and point-to-point link supported by an access point. These limits are used to evaluate a client's connection to the SSID and the connection to a P2P remote.

#### Additions to the menu system

##### Network alarm limits

This table contains the settings for the network alarm limits for the device's logical WLAN networks (SSIDs).

**Telnet path:** /Setup/Interfaces/WLAN

##### Interface

Select the logical WLAN network (SSID) for which you want to edit the network alarm limits.

**Telnet path:** /Setup/Interfaces/WLAN/Network-Alarm-Limits

**Possible values:**

- Choose from the SSIDs available in the device, e.g. WLAN-1, WLAN-2, etc.

**Phy signal**

The negative threshold value for the signal level of the corresponding SSID. If the value falls below this threshold, an alarm is issued. Setting this value to 0 deactivates the check.

**Telnet path:** /Setup/Interfaces/WLAN/Network-Alarm-Limits

**Possible values:**

- 3 numerical characters

**Default:** 0

**Total retries**

The threshold value for the total number of transmission retries for the corresponding SSID. Once the value is reached, an alarm is issued. Setting this value to 0 deactivates the check.

**Telnet path:** /Setup/Interfaces/WLAN/Network-Alarm-Limits

**Possible values:**

- 4 numeric characters to specify the repetitions in per mille

**Default:** 0 per mille

**TX errors**

The total number of lost packets for the corresponding SSID. Once the value is reached, an alarm is issued. Setting this value to 0 deactivates the check.

**Telnet path:** /Setup/Interfaces/WLAN/Network-Alarm-Limits

**Possible values:**

- 4 numeric characters to specify the repetitions in per mille

**Default:** 0 per mille

## 13.14.2 Interpoint alarm limits

### Additions to the menu system

#### Interpoint alarm limits

This table contains the settings for the interpoint alarm limits for the device's P2P connections (SSIDs).

**Telnet path:** /Setup/Interfaces/WLAN

#### Interface

Select the P2P connection here for which you wish to set the interpoint alarm limits.

**Telnet path:** /Setup/Interfaces/WLAN/Interpoint-Alarm-Limits

**Possible values:**

- Choose from the P2P connections available in the device, e.g. P2P-1, P2P-2, etc.

#### Phy signal

The negative threshold value for the signal level of the corresponding P2P connection. If the value falls below this threshold, an alarm is issued. Setting this value to 0 deactivates the check.

**Telnet path:** /Setup/Interfaces/WLAN/Interpoint-Alarm-Limits

**Possible values:**

- 3 numerical characters

**Default:** 0**Total retries**

The threshold value for the total number of transmission retries for the corresponding P2P connection. Once the value is reached, an alarm is issued. Setting this value to 0 deactivates the check.

**Telnet path:** /Setup/Interfaces/WLAN/Interpoint-Alarm-Limits**Possible values:**

- 4 numeric characters to specify the repetitions in per mille

**Default:** 0 per mille**TX errors**

The total number of lost packets for the corresponding P2P connection. Once the value is reached, an alarm is issued. Setting this value to 0 deactivates the check.

**Telnet path:** /Setup/Interfaces/WLAN/Interpoint-Alarm-Limits**Possible values:**

- 4 numeric characters to specify the repetitions in per mille

**Default:** 0 per mille

### 13.14.3 IEEE 802.11e user priority converted into VLAN tags

IEEE 802.11e is an extension to the WLAN standards that incorporates quality-of-service (QoS) functions. An access point operating this standard can assign a user priority to each wireless client associated with it. By prioritizing wireless data packets, the access point can provide preferred handling for voice over IP clients, for example. On the LAN side, access points are commonly connected with a switch, and different LAN segments are often separated by VLANs. The wired LAN uses other mechanisms for the prioritization of data packets.

The following example application illustrates this:

- A wireless client (e.g. VoIP phone) is connected to an access point, QoS is enabled on the WLAN, the data between the phone and access point is not VLAN tagged.
- On the Ethernet side, the access point is connected to a VLAN-capable switch, and the data between AP and switch is VLAN tagged.

The access point is the interface between wired LAN and wireless LAN, and it converts the different prioritization information accordingly:

- When an access point receives data for transfer to a WLAN client, it determines the priority of each data packet either from the VLAN tag or the ToS/DSCP field in the IP header. The access point sends the packets to the client with this priority.
- However, data packets transferred from the WLAN client to the access point do not have a VLAN tag. What's more, in this direction the access point does not inspect the IP header. Instead, the access point takes the user priority of the WLAN packet and translates this into the appropriate VLAN tag to be attached to outgoing data packets on their way to the switch.

## 13.15 Addition(s) to LCOS 8.60

### 13.15.1 Adjustable rate adaption algorithm

Unlike an Ethernet connection, a wireless connection uses variable bit rates. Higher bit rates provide a better throughput, but they require a high signal quality at the receiver end. This is essential for error-free decoding. WLAN devices adapt their bit rate the first time a connection is made or if there is a change to the properties of the medium. This ensures that the device uses the best available bit rate.

Unlike the standard algorithm, the well-known Minstrel algorithm checks not only the neighboring bit rates, but all available bit rates. This is a quicker way of determining the optimal bit rate.

#### Additions to the menu system

##### Method

You have the option to set the desired rate adaptation algorithm.

##### SNMP ID:

2.12.51.1

##### Telnet path:

**Setup > WLAN > Rate-Adaptation**

##### Possible values:

standards

Minstrel

##### Default:

Minstrel

##### Initial rate

The initial rate determines the starting bit rate that the algorithm uses to determine the optimal bit rate.

##### SNMP ID:

2.12.51.2

##### Telnet path:

**Setup > WLAN > Rate-Adaptation**

##### Possible values:

Minimum

RSSI-derived

##### Default:

Minimum

##### Minstrel averaging factor

The averaging factor used for recalculating the net rates for each bit rate according to the Minstrel method.

##### SNMP ID:

2.12.51.3

**Telnet path:****Setup > WLAN > Rate-Adaptation****Possible values:**

0 to 99

**Default:**

75

**Standard averaging factor**

The averaging factor used for recalculating the net rates for each bit rate according to the standard method.

**SNMP ID:**

2.12.51.4

**Telnet path:****Setup > WLAN > Rate-Adaptation****Possible values:**

0 to 99

**Default:**

0

## 13.16 Addition(s) to LCOS 8.80

### 13.16.1 Spectral scan

In addition to connecting computers to the Internet, professional users are increasingly using wireless local area networks (WLAN) for business-critical applications. Examples include accessing of patient files, online monitoring of production facilities, and the transmission of video and audio data (ideally without any time lags). The reliability and performance of WLAN systems are thus increasingly important.

The rising significance and usage of WLAN for data transmission is resulting in more and more scenarios where the equipment and systems of various users are crowding the WLAN frequency ranges. These may include, for example, microwave ovens, cordless telephones, Bluetooth devices and video transmitters, with their signals occurring on a continual or intermittent basis. The simultaneous usage of a frequency band or frequency range gives rise to interference that can disrupt or negatively impact the reliability and performance of a WLAN. This type of interference can result in data packets or connections being lost. If the interference is too strong, the complete failure of the WLAN may result.

It is therefore becoming increasingly important to use targeted analysis to check the frequency ranges. These checks should identify the interference or other interference factors, and introduce countermeasures as required. It can also be used to ensure that the WLAN is working properly and operating interference free.

Targeted analysis can also clarify or identify the following:

- Proper, fault-free operation of the WLAN
- Existence of interference or noise
- Display or identify the bands with interference
- Strength of the interference signal
- Regularity or frequency of the interference signal
- Type, and possibly source, of the interference signal

The WLAN-related frequency ranges are subject to spectral analysis. Results are displayed graphically, i. e. in the form of real-time diagrams or real-time overviews of frequencies and interference. However, graphical analyses of a spectral range are open to some freedom of interpretation. Therefore, the following scenario should be fairly commonplace: You ascertain that the frequency currently being used is being subjected to interference that is continual and of constant signal strength. However, you are not able to ascertain unequivocally which room or building the signal is coming from, nor the type of equipment which is transmitting the interfering signal.

## Functions of the software module

The "Spectral Scan" software module enables you to run a spectral analysis directly on the access point. There is not need to purchase any additional software or hardware as the integrated functionality can be used to analyze the frequency ranges and bands in question. This gives you a graphical overview of the frequency response characteristics within your WLAN at all times so that you can detect interference and safeguard against it.

Clicking on the menu option **Extras > Spectral scan** in WEBconfig opens the window shown below:

**Spectral Scan**

Interfaces	Radio-Bands	Subbands	
WLAN-1:	2.4GHz/5GHz	Band-1+2+3	Start

This page is used to start and stop the spectral analyser.  
Depending on the current state of the analyser, different buttons and selections will be available:

**Selection "Radio-Bands"**  
This selection defines which radio bands will be analysed once the spectrum analyser is started. In case it is running already the selection will be shown greyed-out.

**Selection "Subbands"**  
If 5 GHz is selected as one of the radio bands the selection of subbands will be displayed to allow further specification of the frequency range to be analysed. The selection will be shown greyed-out if the spectrum analyser is running already.

**Button "Start"**  
The spectrum analyser is started on the respective WLAN module by pressing this button. For each selected frequency band one additional window will be opened to display the results of the spectrum analyser. As long as the spectrum analyser is active, the WLAN module is unavailable for data transfers.

**Button "Stop"**  
Stopping the spectrum analyser will revert the state of the WLAN module to the previous settings.

**Button "Show"**  
This button will open one window for each selected frequency band to display the results of the spectrum analyser.

⚠ When the WLAN module is disabled (**Setup > Interfaces > WLAN > Operational**), a message is displayed and the spectral scan cannot be started. Configure the access point for "Base station" operation or ensure that a WLAN controller configures the access point.

The following entries, buttons and selection menus are available here:

- **Interfaces:** Shows the selected WLAN module for analysis.
- **Radio bands:** Use this selection menu to set which frequency band(s) you wish to analyze. The relevant field is grayed out once the spectral scan has started on this module.
- **Sub-bands:** This selection menu is only enabled if '5GHz' or '2.4GHz/5Ghz' is selected in **Radio bands**. You are then able to specify which sub-bands of the 5GHz band are included in the analysis.
- **Start:** Clicking this button starts the spectral scan on the relevant WLAN module. A separate window opens for each of the selected frequency bands.
- **Stop:** This buttons ends the analysis. The WLAN module then returns to the previous mode and is available again with its usual functionality.

⚠ This button is only shown once the module has been started.



- **Show:** Once the spectral scan has started, click this button to open a window for each selected frequency band. Click the button repeatedly to open multiple windows.

The spectral scan can also be started from the LANmonitor. To do this, right-click the relevant device in the list and select **Show spectral scan** in the context dialog.

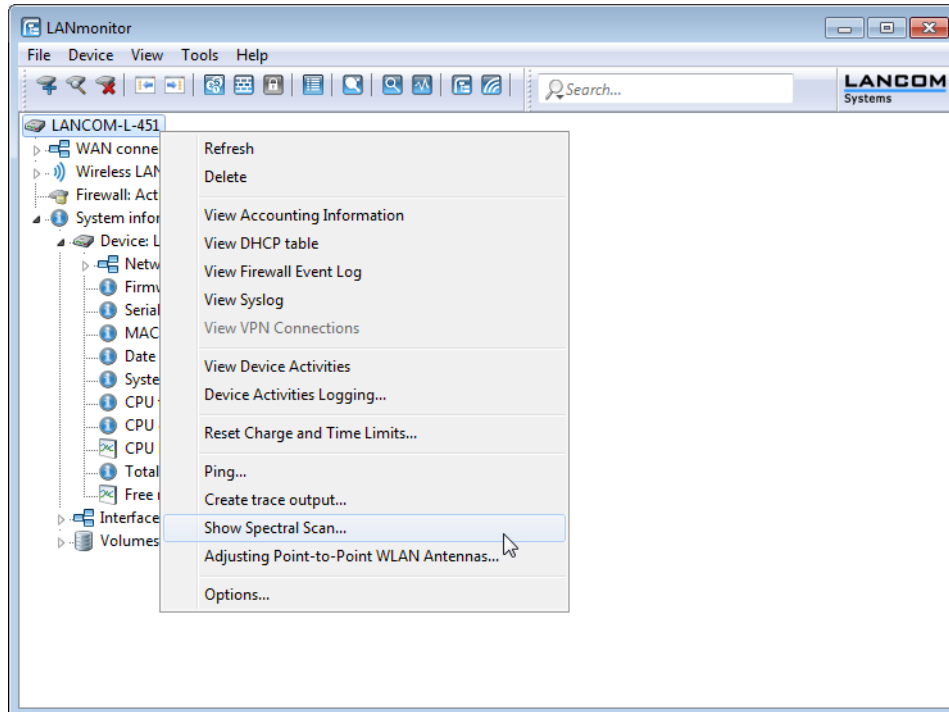

A browser window opens showing you the same entries, buttons and selection menus as those in WEBconfig.

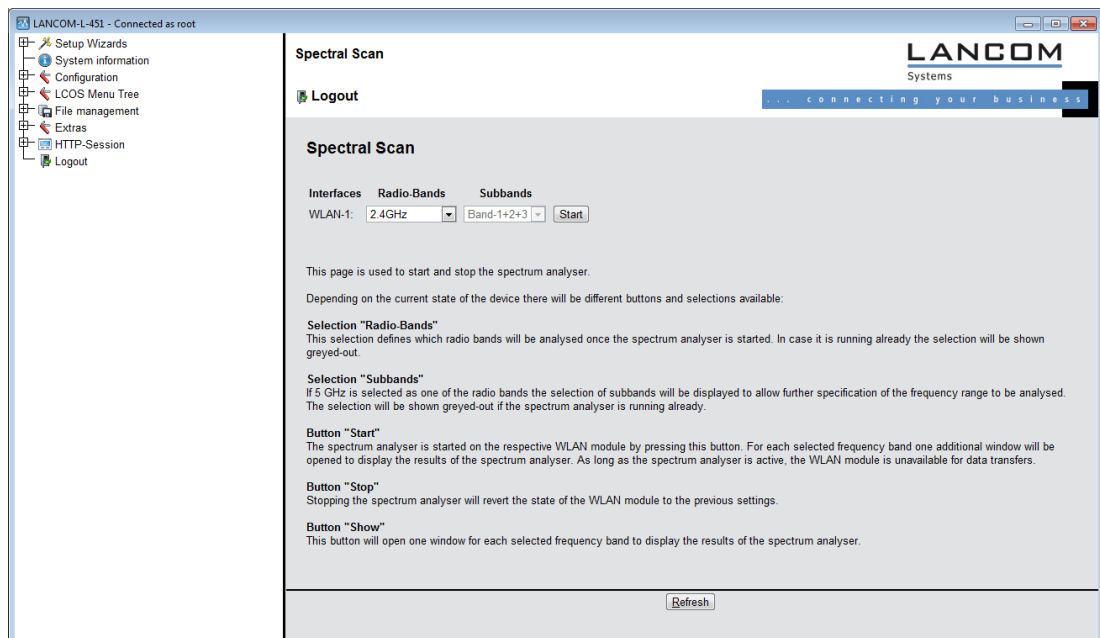

⚠ During the analysis, the WLAN module being analyzed does not send any data or transmit any SSID.

⚠ The "Spectral Scan" function is supported by LANCOM access points of the L-4xx series, L-32x series, and the models 1781AW, 1781EW and 1780EW-3G only.

## Spectral scan analysis window

 The spectral scan is displayed in a browser application. For this to work properly, your browser must support the latest version of WebSockets, and the HTML5 element `<canvas>`. The browser in LANmonitor meets all of these requirements.

In the separate analysis window of the spectral scan, there are different ways to show the frequencies and frequency ranges together with the potential interference. The following buttons are available at the top of the window:

- **Current:** Shows or hides the curve of the values being measured.
- **Maximum:** Shows or hides the maximum values of the ongoing spectrum scan in relation to the currently set history range.
- **Average:** Shows or hides the average values of the ongoing spectrum scan in relation to the currently set history range.
- **History:** Shows or hides the values last measured.
- **Number of history values:** Determines the number of results last measured that are displayed. You are able to show at least the last 5 and at most the last 50 measuring points for every frequency.
- **Last channel:** Shows or hides the channel last used.
- **Frequency:** Switches the display on the X-axis between WLAN channel and frequency.

The window contains two graphical views showing the readings in a different manner. The top diagram shows the signal strength in dBm on the Y-axis, and either the WLAN channel or the relevant frequency on the X-axis. The lower diagram contains the analysis progression over time in the form of a waterfall diagram, with the Y-axis showing the time and the X-axis again showing the WLAN channel or the relevant frequency. These view formats depict both continuous and occasional interference on the frequencies, so helping you to take appropriate action to improve the connection (e. g. by changing the channel or identifying and eliminating the interference source). For example, certain interference sources such as microwave devices, DECT telephones (working in the 2.4GHz frequency range) and audio-video transmitters exhibit very typical transmit patterns that occur prominently in both diagrams.

On the lower border of the window is a slider denoted **Time slider**. This enables you to extend or limit the time period analyzed in the waterfall diagram. Alternatively, you can use the input box to the right of the slider to select how many readings you would like to display in the waterfall diagram. The web application can display up to 300 readings in the waterfall diagram using the time slider. The readings from a maximum of 24 hours can be cached.

Below are some example analysis results showing graphically other settings in a different way:

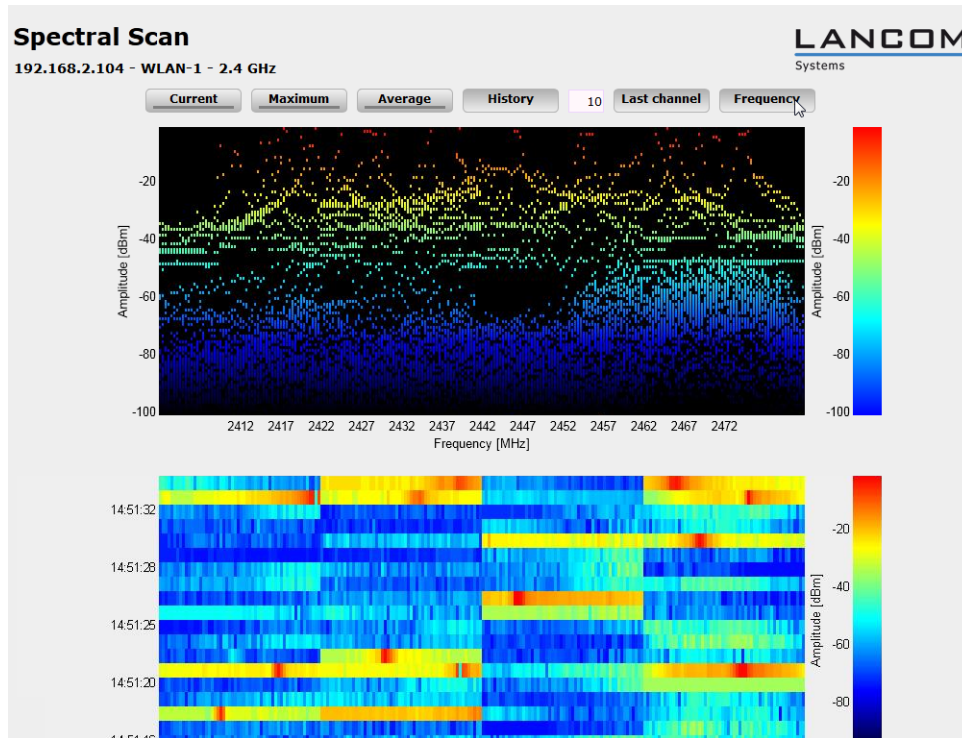

Figure 1: Spectral scan, frequency display of the last 10 history values

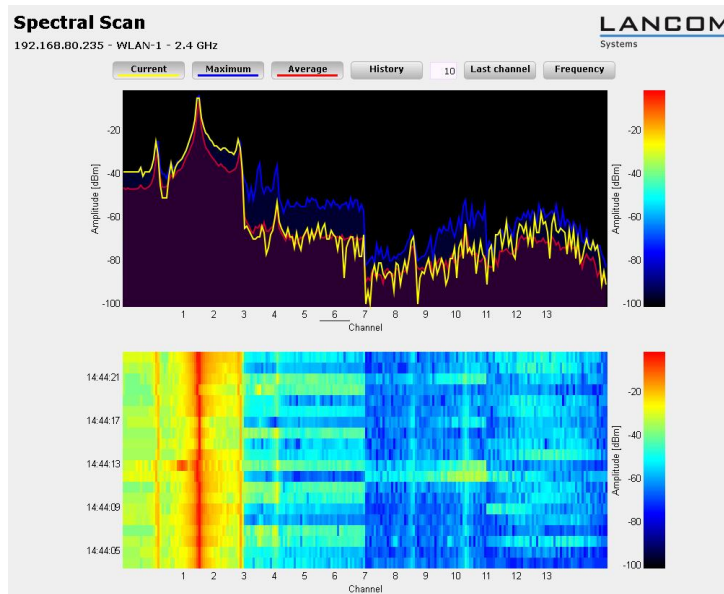

Figure 2: Spectral scan, channel display of Current, Maximum and Average, interference from radio camera

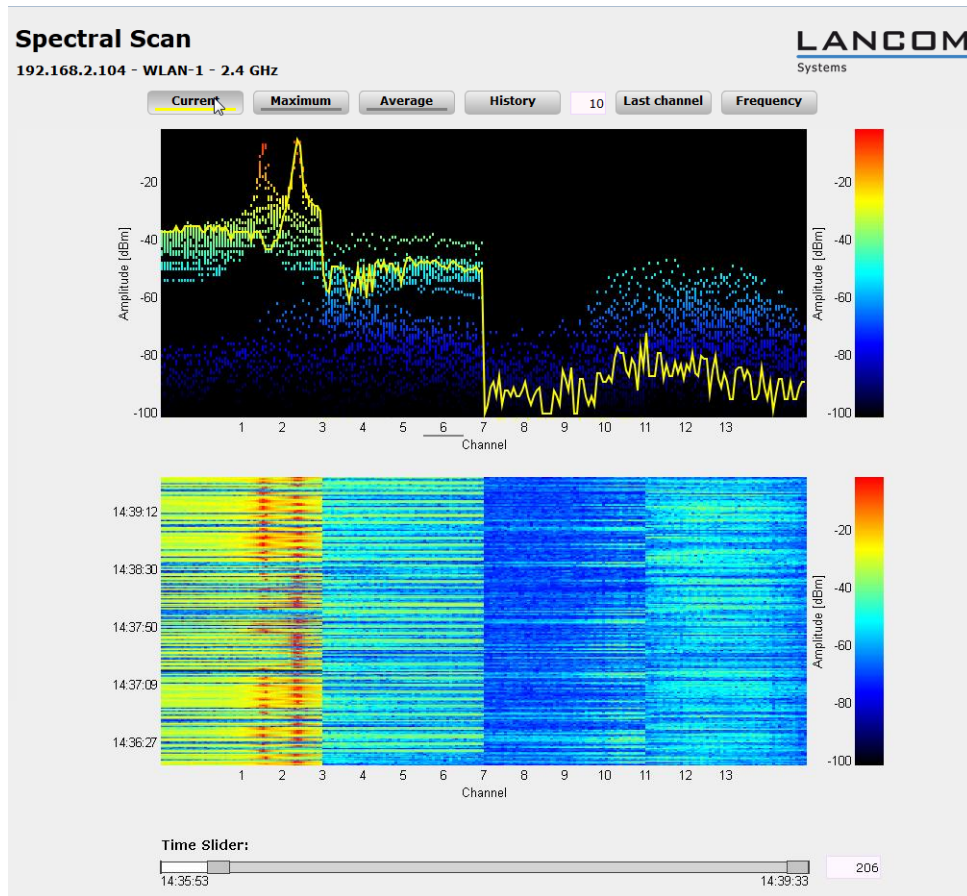

Figure 3: Spectral scan, channel display of Current, last 10 history values and "Time Slider", interference from baby phone

## Enhancements to LANmonitor

### LANmonitor application concepts

This section outlines different application concepts for LANmonitor, such as using SNMP to query CPU and memory utilization, or performing spectral scans.

## Spectral scan

Right-click the relevant device in the list and select **Show spectrum analyzer** in the context dialog.

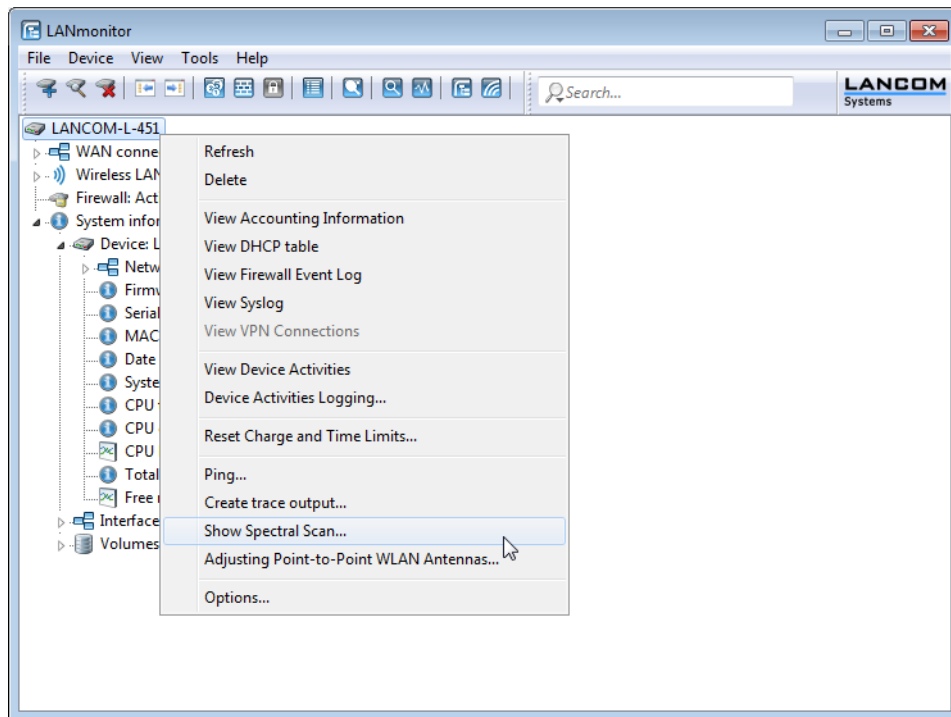

The following entries, buttons and selection menus are available here:

- **Interfaces:** Shows the selected WLAN module for analysis.
- **Radio bands:** Use this selection menu to set which frequency band(s) you wish to analyze. The relevant field is grayed out once the spectral scan has started on this module.
- **Sub-bands:** This selection menu is only enabled if '5GHz' or '2.4GHz/5Ghz' is selected in **Radio bands**. You are then able to specify which sub-bands of the 5GHz band are included in the analysis.
- **Start:** Clicking this button starts the spectral scan on the relevant WLAN module. A separate window opens for each of the selected frequency bands.
- **Stop:** This buttons ends the analysis. The WLAN module then returns to the previous mode and is available again with its usual functionality.

! This button is only shown once the module has been started.

- **Show:** Once the spectral scan has started, click this button to open a window for each selected frequency band. Click the button repeatedly to open multiple windows.

! Please refer to Section [Spectral scan analysis window](#) for further information on the diagrams displayed.

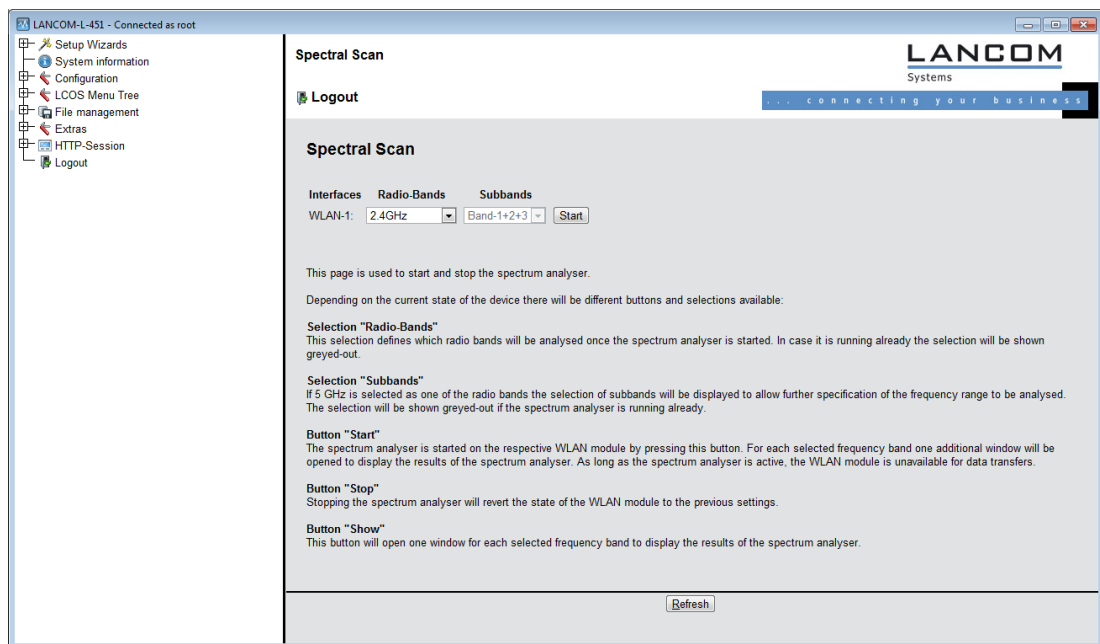

! During the analysis, the WLAN module being analyzed does not send any data or transmit any SSID.

! The "Spectral Scan" function is supported by LANCOM access points of the L-4xx series, L-32x series, and the models 1781AW, 1781EW and 1780EW-3G only.

## Additions to the Setup menu

### Operation mode

All LANCOM wireless devices can be operated in various modes.

#### SNMP ID:

2.23.20.7.3

#### Telnet path:

**Setup > Interfaces > WLAN > Operational**

#### Possible values:

**Access Point:** As a base station (access point), the device establishes the link to a wired LAN for the WLAN clients.

**Station:** As a station (client), the device itself locates the connection to another access point and attempts to register with a wireless network. In this case the device serves to connect a wired device to a base station over a point-to-point link.

**Managed AP:** As a managed access point, the device searches for a central WLAN controller from which it can obtain a configuration.

**Probe:** In 'Probe' mode, the spectral scan uses the radio module of the access point. The device cannot transmit or receive data in this mode. On startup of the spectral scan, the device automatically switches to 'Probe' mode so that this setting need not be configured manually.

**Default:****LANCOM Wireless Router:** Access Point**LANCOM Access Points:** Managed AP**Probe settings**

This table contains the settings for the spectral scan.

---

 The device cannot transmit or receive data in this mode.

**SNMP ID:**

2.23.20.15

**Telnet path:****Setup > Interfaces > WLAN****Ifc**

Opens the settings for the physical WLAN interface.

**SNMP ID:**

2.23.20.15.1

**Telnet path:****Setup > Interfaces > WLAN > Probe-Settings****Possible values:**

Selection from the available physical WLAN interfaces.

**Radio bands**

Here you can select which frequency bands should be analyzed by spectral scanning.

**SNMP ID:**

2.23.20.15.2

**Telnet path:****Setup > Interfaces > WLAN > Probe-Settings****Possible values:**

2.4GHz

5GHz

2.4GHz/5GHz

**Default:**

2.4GHz

**Subbands 2.4GHz**

This setting determines which subbands of the 2.4GHz frequency are to be analyzed.

---

 The spectral scan only takes this field into account when either '2.4GHz' or '2.4GHz/5GHz' is set in **Radio bands**.

**SNMP ID:**

2.23.20.15.3

**Telnet path:****Setup > Interfaces > WLAN > Probe-Settings****Possible values:**

Band-1

Band-2

Band-1+2

**Default:**

Band-1

**Channel list 2.4GHz**

Specify in this field the list of channels for the spectral scan in the 2.4GHz frequency band. Individual channels are separated with commas.

There is no need to change the default values of the spectral scan for its operation. The spectral scan examines 20MHz-wide frequency bands at a time. Due to the 5MHz gaps between the individual 20MHz-wide channels in the 2.4GHz radio band, the channels specified result in a continuous scan of the entire 2.4GHz radio band. In the 5GHz band, the channel bandwidth is also 20MHz, and the individual channels lie next to each other with no overlapping. When no channels are specified, all channels are scanned which results in a complete scan in the 5GHz band.

**SNMP ID:**

2.23.20.15.4

**Telnet path:****Setup > Interfaces > WLAN > Probe-Settings****Possible values:**

Max. 48 characters

from ABCDEFGHIJKLMNOPQRSTUVWXYZ@{}~!\$%&amp;'()+-./,:;&lt;=&gt;?[ \]^\_0123456789

**Default:**

1, 5, 9, 13

**Subbands 5GHz**

This setting specifies which subbands of the 5GHz frequency are to be analyzed.



The spectral scan only takes this field into account when either '5GHz' or '2.4GHz/5GHz' is set in **Radio bands**.

**SNMP ID:**

2.23.20.15.5

**Telnet path:****Setup > Interfaces > WLAN > Probe-Settings****Possible values:**

Band-1

Band-2

Band-1+2

**Default:**

Band-1



**Channel list 5GHz**

In this field, specify the list of channels for the spectral scan in the 5GHz frequency band. Individual channels are separated with commas.

**SNMP ID:**

2.23.20.15.6

**Telnet path:**

**Setup > Interfaces > WLAN > Probe-Settings**

**Possible values:**

Max. 48 characters

from ABCDEFGHIJKLMNOPQRSTUVWXYZ@{}~!\$%&'()\*+,-./:;<=>?[]^\_0123456789

**Default:**

Blank

**Channel dwell time**

Determine here the number of milliseconds the spectral scan dwells on a channel.

The web application can display up to 300 readings in the waterfall diagram using the time slider. The readings from a maximum of 24 hours can be cached. The default value is generally adequate. Only lower the value when you need a more accurate resolution, and when the performance of your browser and PC is high enough to process the faster display of the readings.

**SNMP ID:**

2.23.20.15.7

**Telnet path:**

**Setup > Interfaces > WLAN > Probe-Settings**

**Possible values:**

Max. 10 characters

from 0 to 9

**Default:**

250

## 13.16.2 WLAN band steering

The IEEE 802.11 standard contains virtually no criteria by which a WLAN client should select the access point for a connection. While there are general guidelines according to which preference is given to an access point with a higher RSSI value (i. e. the received signal strength), for example, WLAN clients do not, in practice, adhere strictly to these definitions or the general guidelines. If both 2.4GHz and 5GHz are used to broadcast an SSID, there is normally no way of influencing the client as regards the preferred frequency band.

The steering of WLAN clients is based on the principle that many clients determine the available access points by means of an active scan. Active scanning here means that a client sends probe requests containing the network ID to which the client is to connect. Access points with this ID then send a test response, enabling the client to create a list of available access points. The vast majority of WLAN clients only connect to access points from which they have received a probe response, and this can be used to steer their selection process.

There are multiple, sometimes very advanced, criteria for steering. One of these criteria relates to the wireless frequency ranges used for client communication. Modern dual-band WLAN clients are expected to prefer the 5GHz frequency band over the (now) overcrowded 2.4GHz band. Band steering is the term given to purposefully assigning a WLAN client a particular frequency band or range.

The list of detected or "seen" clients contains all clients from which the access point has received a test request packet. In combination with the radio frequency on which the WLAN client sends the test request, this list is one of the bases on which the access point decides whether to respond to the request or not.

Other criteria depend on the reported client IDs and the configuration of the devices. It may be the case, for example, that fewer SSIDs are reported on the preferred frequency band than are on the one with the lower preference. Similarly, too low a transmit strength when SSIDs are reported can result in the client not receiving any probe responses at all on the preferred frequency band. For the latter scenario, it is important to ensure that the access point does not suppress probe responses on the less favored frequency band. The minimum signal strength responsible here can be set in the following ways :

- **LANconfig: Wireless LAN > General > Logical WLAN settings > Network > Minimum client signal strength**
- **WEBconfig: Setup > Interfaces > WLAN > Network > Minimum station strength**

In LANconfig you can use **Wireless LAN > Band steering** to enable and manage the access point's band steering function.

## Enhancements to LANconfig

### Band steering

This dialog enables you to configure the settings for band steering in LANconfig.

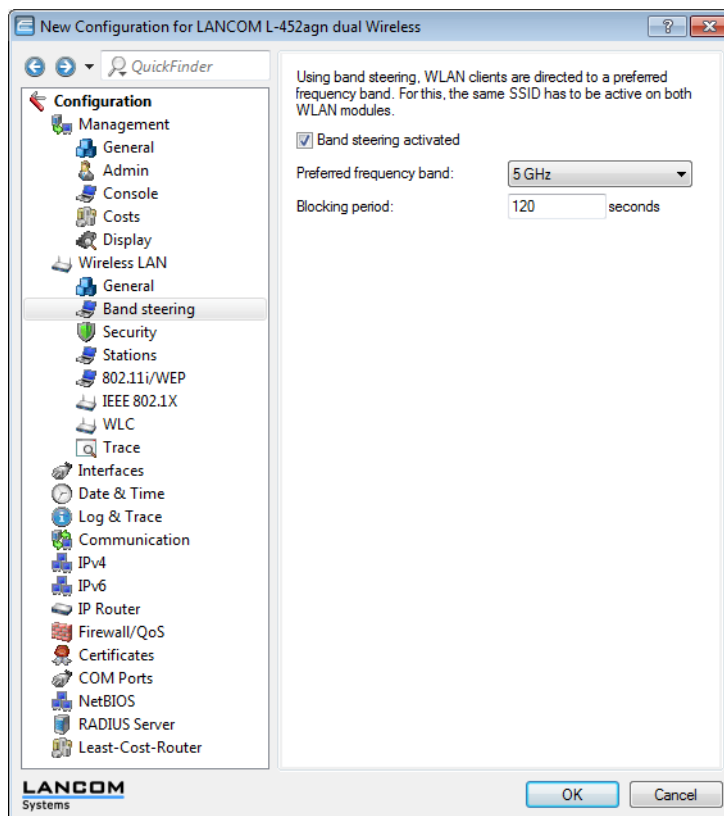

The following functions are available in **Wireless LAN > Band steering**:

- **Band steering enabled:** Enables or disables this function.
- **Preferred frequency band:** Specifies the frequency band to which the device steers WLAN clients. Possible values:
  - **2.4GHz:** The device routes clients to frequency band 2.4GHz.
  - **5GHz:** The device routes clients to frequency band 5GHz.

- **Block time:** The time for which the access point steers the WLAN client to the preferred frequency band. The default value is 120 seconds.

## Additions to the Setup menu

### Client steering

This is where you determine the 'WLAN band steering' settings of the WLAN clients registered at the access point.

**SNMP ID:**

2.12.87

**Telnet path:**

**Setup > WLAN**

### Operating

This option enables 'client steering' in the access point.

**SNMP ID:**

2.12.87.1

**Telnet path:**

**Setup > WLAN > Client-Steering**

**Possible values:**

Yes

No

**Default:**

No

### Criterion

Determine here the criteria by which the access point controls the WLAN client.

**SNMP ID:**

2.12.87.2

**Telnet path:**

**Setup > WLAN > Client-Steering**

**Possible values:**

Radio-Band

**Default:**

Radio-Band

### Preferred band

Set here the preferred frequency band to which the access point steers the WLAN client.

**SNMP ID:**

2.12.87.3

**Telnet path:**

**Setup > WLAN > Client-Steering**

**Possible values:**

5GHz  
2.4GHz

**Default:**

5GHz

**Probe request ageout seconds**

Set the time (in seconds) that the WLAN client connection should be stored in the access point. When this time expires, the access point deletes the entry from the table.



This value should be set low if you are using clients in the WLAN that, for example, often switch from dual-band to single-band mode.

**SNMP ID:**

2.12.87.3

**Telnet path:**

**Setup > WLAN > Client-Steering**

**Possible values:**

Max. 10 characters  
From 0 to 9

**Special values:**

0: The visible probe requests are deemed invalid immediately.

**Default:**

120

**Additions to the Status menu****Seen clients****SNMP ID:**

1.3.45

**Telnet path:**

**Status > WLAN > Client**

This table contains the following status values:

**Num-ProbeRsp-OK**

Number of probe responses sent to and received by this client.

**Num-ProbeRsp-Bad**

Number of probe responses sent to and not received by this client (Tx errors).

**Num-ProbeRsp-suppressed**

Number of probe responses, which were sent to this client either because its signal strength was below the threshold or because band steering suppressed the response.

**Band**

Displays the WLAN band on which the client last communicated.

## 13.16.3 STBC / LDPC

### Basics

Data transfers according to the IEEE-802.11n standard are performed using MIMO technology (multiple input, multiple output). The sender transmits data packets concurrently over multiple, spatially separated antennas, meaning that reflections and the resulting interference have little effect on the signal. However, the gain in throughput is less with each additional antenna, and the performance requirements for signal processing are increased.

### Low Density Parity Check (LDPC)

Before the sender transmits the data packets, it expands the data stream with checksum bits depending on the modulation rate. These checksum bits allow the receiver to correct transmission errors. By default the 802.11n standard uses 'Convolution Coding' (CC) for error correction, which is well-known from 802.11a and 802.11g; however, the 11n standard also provides for error correction according to the LDPC method (Low Density Parity Check).

In contrast to CC encoding, LDPC encoding uses larger packets to calculate checksums and can also recognize more bit errors. The improved ratio of payload to checksum data enables LDPC encoding to provide a higher data transfer rate.

### Space Time Block Coding (STBC)

The function 'STBC' (Space Time Block coding) additionally varies the transmission of data packets over time to minimize time-related effects on the data. Due to the time offset of the packets the recipient has an even better chance of receiving error-free data packets, regardless of the number of antennas.

## Additions to the Setup menu

### Use STBC

Here you activate the use of STBC for data transfer per logical network (SSID).

---

 If the WLAN chipset does not support STBC, you cannot set this value to **Yes**.

#### SNMP ID:

2.23.20.2.23

#### Telnet path:

**Setup > Interfaces > WLAN > Transmission**

#### Possible values:

Yes

No

#### Default:

Yes (If the WLAN chipset supports STBC)

No (If the WLAN chipset does not support STBC)

### Use LDPC

Here you activate the use of LDPC for data transfer per logical network (SSID).

---

 If the WLAN chipset does not support STBC, you cannot set this value to **Yes**.

#### SNMP ID:

2.23.20.2.24

**Telnet path:****Setup > Interfaces > WLAN > Transmission****Possible values:**

Yes

No

**Default:**

Yes (If the WLAN chipset supports STBC)

No (If the WLAN chipset does not support STBC)

**Additions to the Status menu****Rx-STBC**

This parameter indicates whether the detected remote station can receive data streams in STBC mode, and how many.

**SNMP ID:**

1.3.32.60

**Telnet path:****Status > WLAN > Station-table****Possible values:**

none

One

Two

Three

**LDPC**

This parameter indicates whether the selected WLAN interface supports LDPC encoding.

**SNMP ID:**

1.3.32.61

**Telnet path:****Status > WLAN > Station-table****Possible values:**

Yes

No

**Tx-STBC**

This parameter indicates whether the detected remote station is capable of transmitting with STBC.

**SNMP ID:**

1.3.34.38

**Telnet path:****Status > WLAN > Scan-Results****Possible values:**

Yes

No

**Rx-STBC**

This parameter indicates whether the detected remote station can receive data streams in STBC mode, and how many.

**SNMP ID:**

1.3.34.39

**Telnet path:**

**Status > WLAN > Scan-Results**

**Possible values:**

none

One

Two

Three

**LDPC**

This parameter indicates whether the detected remote station can interpret LDPC-encoded data packets.

**SNMP ID:**

1.3.34.41

**Telnet path:**

**Status > WLAN > Scan-Results**

**Possible values:**

Yes

No

**Rx-STBC**

This parameter indicates whether the detected remote station can receive data streams in STBC mode, and how many.

**SNMP ID:**

1.3.36.1.41

**Telnet path:**

**Status > WLAN > Interpoints > Access-point-list**

**Possible values:**

none

One

Two

Three

**LDPC**

This parameter indicates whether the selected WLAN interface supports LDPC encoding.

**SNMP ID:**

1.3.36.1.42

**Telnet path:****Status > WLAN > Interpoints > Access-point-list****Possible values:**

Yes

No

**Rx-STBC**

This parameter indicates whether the detected remote station can receive data streams in STBC mode, and how many.

**SNMP ID:**

1.3.43.51.38

**Telnet path:****Status > WLAN > Client > Interfaces****Possible values:**

none

One

Two

Three

**LDPC**

This parameter indicates whether the selected WLAN interface supports LDPC encoding.

**SNMP ID:**

1.3.43.51.39

**Telnet path:****Status > WLAN > Client > Interfaces****Possible values:**

Yes

No

**Tx-STBC**

This parameter indicates whether the detected remote station is capable of transmitting with STBC.

**SNMP ID:**

1.3.44.38

**Telnet path:****Status > WLAN > Competing-networks****Possible values:**

Yes

No

**Rx-STBC**

This parameter indicates whether the detected remote station can receive data streams in STBC mode, and how many.



**SNMP ID:**

1.3.44.39

**Telnet path:****Status > WLAN > Competing-networks****Possible values:**

none

One

Two

Three

**LDPC**

This parameter indicates whether the detected remote station can interpret LDPC-encoded data packets.

**SNMP ID:**

1.3.44.41

**Telnet path:****Status > WLAN > Competing-networks****Possible values:**

Yes

No

**Rx-STBC**

This parameter indicates how many data streams the selected WLAN interface can receive when the **STBC** option is enabled.

If **0** is displayed, the WLAN interface does not support STBC.

**SNMP ID:**

1.3.55.34

**Telnet path:****Status > WLAN > WLAN-Parameter****Possible values:**

none

One

Two

Three

**LDPC**

This parameter indicates whether the selected WLAN interface supports LDPC encoding.

**SNMP ID:**

1.3.55.35

**Telnet path:****Status > WLAN > WLAN-Parameter**

**Possible values:**

Yes

No

### 13.16.4 LANCOM-specific UUID information element for access points

As of LCOS version 8.80, LANCOM access points transmit a LANCOM-specific UUID device identifier.

#### UUID info element for LANCOM WLAN access points

All current LANCOM access points have multi-SSID capability. This means that they can simultaneously present different 'virtual' access points to their WLAN clients.

For devices with two radio modules (dual radio), the BSSIDs relate to the logical networks on the corresponding radio module. However, the MAC addresses of the two radio modules are completely independent of one another. Consequently, logical networks with different BSSIDs cannot be unequivocally related to a single device.

However, for the planning and monitoring of networks, it is often desirable to be able to relate logical networks to their respective devices (or radio modules).

LANCOM access points support an Aironet-compatible information element that contains the name of the device as assigned to it by the administrator. The transmission of this information is optional and many operators disable it for security reasons because they want to publish as little information as possible about the access point on the network.

Thus, this information either does not appear for network monitoring at all or, depending on the setting, the information may not identify the device as a LANCOM access point.

Besides this, LANCOM access points possess a UUID (universally unique identifier), which is calculated from the device type and serial number and can identify the device uniquely on the network. By using encryption when generating the UUID, the device type or serial number can only be inferred with considerable effort (brute-force attack for all types of devices and serial numbers).

Transmission of the UUID can be switched on or off independent of the radio module and logical network.

#### Additions to the Setup menu

##### Include UUID

Here you can determine whether the corresponding radio module should transfer its UUID.

**SNMP ID:**

2.23.20.1.17

**Telnet path:****Setup > Interfaces > WLAN > Network****Possible values:**

Yes

No

**Default:**

Yes

### 13.16.5 DFS

This section contains information about DFS (Dynamic Frequency Selection).

## DFS4

As of LCOS version 8.80 all devices transmitting on the 5GHz WLAN frequencies support the standard ETSI EN 301 893 V1. 6. 1 ("DFS4").

### Function and the history of development

For the DFS method (Dynamic Frequency Selection) required for 5 GHz WLANs, an unused frequency is automatically selected, for example, to avoid interference from radar systems. Occasionally, however, signals from weather radar stations cannot be identified reliably.

For this reason the European Commission is extending the requirements of the standards ETSI EN 301 893 V1.3.1 and ETSI EN 301 893 V1.4.1 to additionally avoid the use of three channels (120, 124 and 128) in subband 2 of the 5 GHz band, and not to allow use of these bands for automatic channel selection until a process to auto-detect weather radar station signals is made available. The versions EN 301 893 V1.3 and EN 301 893 V1.4 are referred to as "DFS2"

In the middle of 2010 the new version ETSI EN 301 893 V1.5.1 came into force, which was accompanied by changes in the usage of WLAN frequencies in the ranges 5.25 to 5.35 GHz and 5.47 to 5.725 GHz. The new Version 1.5.1 regulates the DFS (Dynamic Frequency Selection) method for the protection of radar stations from WLAN systems working in this frequency range. By using DFS to detect certain patterns in the radio signals received, it is now possible to detect active radar stations, and WLAN systems can automatically switch their operating channel. To differentiate from previous regulations, the new standard EN 301 893-V1.5 for the updated DFS is referred to as "DFS3".

A pulse pattern can generally be described in terms of its pulse rate, pulse width and the number of pulses. Former DFS technology was only able to detect fixed radar patterns as defined by the various combinations of pulse rates and pulse widths which were stored in the WLAN device. According to DFS3, the device is now able to recognize changing pulse rates and pulse widths as radar patterns. Furthermore, two or three different pulse rates may be used within a radar signal.

The version ETSI EN 301 893 V1.5.1 (DFS-3) expires on 01/01/2013. The new version ETSI EN 301 893 v1.6.1 (known as "DFS4"), which also detects shorter radar pulses, applies thereafter.

 The recognition of weather radar stations (channels 120, 124 and 128 in the 5.6 to 5.65 MHz frequency range) is subject to special conditions. The DFS implementation in LCOS does not support the more stringent recognition conditions. Therefore, these three channels will be omitted from newer versions of LCOS.

### Additions to the Setup menu

#### Preferred DFS scheme

All WLAN systems that have been put into operation since EN 301 893-V1.6 came into effect are required to use DFS4 in the 5GHz band.

Here you can select DFS2 (EN 301 893-V1.3), DFS3 (EN 301 893-V1.5) or DFS4 (EN 301 893-V1.6).

#### SNMP ID:

2.23.20.8.20

#### Telnet path:

**Setup > Interfaces > WLAN > Radio-settings > Preferred-DFS-Scheme**

#### Possible values:

EN 301 893-V1.3

EN 301 893-V1.5

EN 301 893-V1.6

#### Default:

EN 301 893-V1.6

---

 When upgrading from a firmware version older than LCOS version 8.80 to an LCOS version 8.80 or higher, the existing setting of DFS3 (EN 301 893-V1.5) remains in effect.

### 13.16.6 PMK caching in the WLAN client mode

When establishing a connection from a WLAN client to an access point operating with 802.1x-authentication, the two stations negotiate a shared key, known as the Pairwise Master Key (PMK), for the subsequent encryption. In applications with mobile WLAN clients (laptops in large offices, moving objects with WLAN connections in the industrial sector), the WLAN clients often change the access points via which they are logged in to the WLAN network. And although WLAN clients roam back and forth between different access points, in most cases these tend to be the same ones.

Access points typically save a negotiated PMK for a certain period of time. WLAN devices in WLAN client mode also store PMKs. As soon as a WLAN client starts a login procedure for which a connection already existed, the WLAN client can directly transfer the existing PMK to the access point. In this way, the two remote stations skip the PMK negotiation phase while establishing the connection, and the WLAN client and access point establish the connection much faster.

The WLAN client stores the negotiated PMK for the duration set under *Default lifetime*.

#### Additions to the Setup menu

##### PMK caching

Enables PMK caching in WLAN client mode

##### SNMP ID:

2.23.20.3.15

##### Telnet path:

**Setup > Interfaces > WLAN > Encryption**

##### Possible values:

Yes

No

##### Default:

No

##### PMK-Caching

Manage PMK-caching here.

##### SNMP ID:

2.12.85

##### Telnet path:

**Setup > WLAN > PMK-Caching**

##### Default lifetime

Specifies the duration in seconds that the WLAN client stores the negotiated PMK.

---

 Make sure that the time set here matches the session timeout in the accept message that the access point or RADIUS server sends to the WLAN client. Once this time has expired, the access point or RADIUS server requires a re-authentication.

##### SNMP ID:

2.12.85.1

**Telnet path:**

**Setup > WLAN > PMK-Caching**

**Possible values:**

0 to 4294967295

**Default:**

0

**Special values:**

0: The negotiated PMK expires immediately.

**Additions to the Status menu****PMK caching**

This directory contains the status of the PMK caches.

**SNMP ID:**

1.3.60

**Telnet path:**

**Status > WLAN > PMK-Caching**

**Contents**

This table contains all entries of the PMK caches.

**SNMP ID:**

1.3.60.1

**Telnet path:**

**Status > WLAN > PMK-Caching > Content**

**Authenticator**

This entry contains the MAC address of the authenticating access points.

**SNMP ID:**

1.3.60.1.1

**Telnet path:**

**Status > WLAN > PMK-Caching > Content**

**Supplicant**

This entry contains the MAC address of the authenticating WLAN client.

**SNMP ID:**

1.3.60.1.2

**Telnet path:**

**Status > WLAN > PMK-Caching > Content**

**User name**

This entry contains the user name, which the RADIUS server sends to the access point for access permission.

---

 If the RADIUS server does not transmit a user name, this field is left blank.

**SNMP ID:**

1.3.60.1.4

**Telnet path:****Status > WLAN > PMK-Caching > Content****VLAN-ID**

This entry contains the VLAN-ID, which the RADIUS server sends to the access point for access permission.

---

 If the RADIUS server does not transmit a VLAN-ID, this field is left blank.

**SNMP ID:**

1.3.60.1.4

**Telnet path:****Status > WLAN > PMK-Caching > Content****Lifetime**

This entry contains the lifetime of the PMKs in seconds. It is calculated from the validity of the session, which the RADIUS server transmitted with the access permission.

The value is 0 seconds if the RADIUS server did not transmit a duration or the PMK does not have a validity period.

**SNMP ID:**

1.3.60.1.5

**Telnet path:****Status > WLAN > PMK-Caching > Content****Lifetime**

This entry shows whether a PMK has expired. If this is the case, the access point no longer accepts PMK-caching or authentication attempts with this PMK. Instead, it will launch a new 802.1x authentication.

**SNMP ID:**

1.3.60.1.6

**Telnet path:****Status > WLAN > PMK-Caching > Content****Source**

This entry indicates how the WLAN client obtained the PMK:

- **Unknown:** The source is unknown. This entry should not occur in normal operation.
- **Authentication:** PMK is the result of a normal 802.1x-authentication between WLAN-client and access point.
- **Pre-Authentication:** PMK is the result of a normal 802.1x-pre-authentication between the WLAN client and another access point.

**SNMP ID:**

1.3.60.1.7

**Telnet path:****Status > WLAN > PMK-Caching > Content**

### 13.16.7 Pre-authentication in WLAN-client mode

Fast authentication by means of the Pairwise Master Key (PMK) only works if the WLAN client was logged on to the access point previously. The WLAN client uses pre-authentication to reduce the time to logon to the access point at the first logon attempt.

Usually, a WLAN client carries out a background scan of the environment to find existing access points that it could connect to. Access points that support WPA2/802.1x can communicate their pre-authentication capability to any WLAN clients that issue requests. A WPA2 pre-authentication differs from a normal 802.1x authentication as follows:

- The WLAN client logs on to the new access point via the infrastructure network, which interconnects the access points. This can be an Ethernet connection or a WDS link (wireless distribution system), or a combination of both connection types.
- A pre-authentication is distinguished from a normal 802.1x authentication by the differing Ethernet protocol (EtherType). This allows the current access point and all other network partners to treat the pre-authentication as a normal data transmission from the WLAN client.
- After successful pre-authentication, the negotiated PMK is stored to the new access point and the WLAN client.

 The use of PMKs is a prerequisite for pre-authentication. Otherwise, pre-authentication is not possible.

- When the client wants to connect to the new access point, the stored PMK significantly accelerates the logon procedure. The further procedure is equivalent to the [PMK caching](#).

 On the client side, the number of concurrent pre-authentications is limited to four. This minimizes the network load on the central RADIUS server in network environments with large numbers of access points.

### Additions to the Setup menu

#### Pre-authentication

Enables pre-authentication support for the corresponding WLAN.

 In order to be able to use pre-authentication, PMK caching must be enabled.

#### SNMP ID:

2.23.20.3.16

#### Telnet path:

**Setup > Interfaces > WLAN > Encryption**

#### Possible values:

Yes

No

#### Default:

No

### 13.16.8 Greenfield mode for access points with IEEE 802.11n

For access points that comply with the IEEE 802.11n standard, the physical WLAN settings provide the option to allow or restrict data transmission according to the IEEE 802.11n standard.

Along with the selection of the individual a/b/g/n standards and a selection of mixed operating modes, the access points provide the option of using the Greenfield mode. Once activated in the physical WLAN settings for a WLAN interface, the Greenfield mode only allows WLAN clients that support the IEEE 802.11n standard to associate with the corresponding logical WLANs (SSIDs). Other WLAN clients that only work with the standards IEEE 802.11a/b/g cannot associate with these WLANs.

The IEEE 802.11n standard only allows connections that are either encrypted with WPA2/AES or unencrypted. WEP- and TKIP-based encryptions are not allowed in IEEE 802.11n. Please be aware of the following restrictions depending on the actual physical and logical WLAN settings:

- If, in the Physical settings, you activate support of a mixed-mode which includes the IEEE 802.11n standard and individual WLAN clients on a logical network only support WEP encryption, then the access point will reduce the transmission rate to the 802.11a/b/g standard, because the higher transfer rates available with IEEE 802.11n are not supported in combination with WEP.
- If, in the Encryption settings for a logical WLAN network, you enable not only AES session keys but also TKIP session keys, then the access point will use only the AES session key for this WLAN, because TKIP is not supported by IEEE 802.11n.
- If, in the Encryption settings for a logical WLAN network, you enable only TKIP session keys, then the access point will reduce the transmission rate to the 802.11a/b/g standard, because the higher transfer rates available with IEEE 802.11n are not supported in combination with TKIP.

### 13.16.9 Separate RADIUS server for each SSID

If you operate RADIUS for the central administration of accounts and access credentials in your wireless network, then the access point forwards requests for the authorization and accounting to the RADIUS server by default. If you are using a WLAN controller for access point management, then the controller can forward RADIUS requests from all of these access points to the RADIUS server.

In some cases, the operator of access points or WLAN controllers may wish to use a different RADIUS server for each logical wireless network (SSID). This may be the case, for example, when multiple customers share the same technical WLAN infrastructure but use their own authentication systems (e.g. with Wireless as a Service – WaaS).

In these cases, you have the option to choose a separate RADIUS profile for each logical WLAN (i.e. each SSID). The RADIUS profile contains all of the necessary information to use the appropriate RADIUS server, including the optional backup solution.

#### Additions to the menu system

##### RADIUS server profiles

By default, the WLAN controller forwards requests for account and access administration to the RADIUS server. In order for the access points to contact the RADIUS server directly, you define the necessary RADIUS profiles in this table. When setting up logical wireless networks (SSIDs), you have the option of choosing a separate RADIUS profile for each SSID.

**SNMP ID:** 2.37.35

**Telnet path:** /Setup/WLAN-Management

##### Name

Name of the RADIUS profile. This name is used to reference the RADIUS profile in the logical WLAN settings.

**SNMP ID:** 2.30.3.1

**Telnet path:** /Setup/WLAN-Management/RADIUS-Server-Profiles

##### Possible values:

- Max. 16 characters

**Default:** Blank

##### Access IP

IP address of the RADIUS server that authenticates user data. In the default setting with the IP address of 0.0.0.0, the access point sends RADIUS requests to the WLAN controller.



**SNMP ID:** 2.37.35.7

**Telnet path:** /Setup/WLAN-Management/RADIUS-Server-Profiles

**Possible values:**

- Valid IP address.

**Default:** 0.0.0.0

#### Access port

Port of the RADIUS server that authenticates user data.

**SNMP ID:** 2.37.35.8

**Telnet path:** /Setup/WLAN-Management/RADIUS-Server-Profiles

**Possible values:**

- Max. 5 numbers

**Default:** 1812

#### Access secret

Password for the RADIUS server that authenticates user data.

**SNMP ID:** 2.37.35.9

**Telnet path:** /Setup/WLAN-Management/RADIUS-Server-Profiles

**Possible values:**

- Max. 32 characters

**Default:** Blank

#### Access loopback

Here, you can optionally configure a sender address for the RADIUS server that authenticates user data. This is used instead of the sender address otherwise selected automatically for the destination address. If you have configured loopback addresses, you can specify them here as sender address.

**SNMP ID:** 2.37.35.10

**Telnet path:** /Setup/WLAN-Management/RADIUS-Server-Profiles

**Possible values:**

- Various forms of entry are accepted:
- Name of the IP networks whose addresses are to be used.
- "INT" for the address of the first intranet.
- "DMZ" for the address of the first DMZ

---

 If there is an interface called "DMZ", its address will be taken in this case.

- LBO... LBF for the 16 loopback addresses.
- Furthermore, any IP address can be entered in the form x.x.x.x.

**Default:** Blank

#### Access protocol

Protocol for communication between the access point and the RADIUS server that authenticates the user data.

**SNMP ID:** 2.37.35.11

**Telnet path:** /Setup/WLAN-Management/RADIUS-Server-Profiles

**Possible values:**

- RADSEC
- RADIUS

**Default:** RADIUS

#### **Account IP**

IP address of the RADIUS server that carries out the accounting of user activities. In the default setting with the IP address of 0.0.0.0, the access point sends RADIUS requests to the WLAN controller.

**SNMP ID:** 2.37.35.2

**Telnet path:** /Setup/WLAN-Management/RADIUS-Server-Profiles

**Possible values:**

- Valid IP address.

**Default:** 0.0.0.0

#### **Account port**

Port of the RADIUS server that carries out the accounting of user activities.

**SNMP ID:** 2.37.35.3

**Telnet path:** /Setup/WLAN-Management/RADIUS-Server-Profiles

**Possible values:**

- Max. 5 numbers

**Default:** 1813

#### **Account secret**

Password for the RADIUS server that carries out the accounting of user activities.

**SNMP ID:** 2.37.35.4

**Telnet path:** /Setup/WLAN-Management/RADIUS-Server-Profiles

**Possible values:**

- Max. 32 characters

**Default:** Blank

#### **Account loopback**

Here, you can optionally configure a sender address for the RADIUS server that carries out the accounting of user activities. This is used instead of the sender address otherwise selected automatically for the destination address. If you have configured loopback addresses, you can specify them here as sender address.

**SNMP ID:** 2.37.35.5

**Telnet path:** /Setup/WLAN-Management/RADIUS-Server-Profiles

**Possible values:**

- Various forms of entry are accepted:
- Name of the IP networks whose addresses are to be used.

- "INT" for the address of the first intranet.
- "DMZ" for the address of the first DMZ



If there is an interface called "DMZ", its address will be taken in this case.

- LBO... LBF for the 16 loopback addresses.
- Furthermore, any IP address can be entered in the form x.x.x.x.

**Default:** Blank

### Account protocol

Protocol for communication between the access point and the RADIUS server that carries out the accounting of user activities.

**SNMP ID:** 2.37.35.6

**Telnet path:** /Setup/WLAN-Management/RADIUS-Server-Profiles

#### Possible values:

- RADSEC
- RADIUS

**Default:** RADIUS

### Backup

Name of the backup RADIUS profile. This name is used to reference the backup RADIUS profile in the logical WLAN settings. The WLAN controller uses the settings from the backup RADIUS profile when the primary RADIUS server for authentication or accounting does not respond to queries.

**SNMP ID:** 2.30.3.12

**Telnet path:** /Setup/WLAN-Management/RADIUS-Server-Profiles

#### Possible values:

- Max. 16 characters

**Default:** Blank

### Network profiles

Here you define the logical WLAN networks for activation and operation via the associated access points (APs).

**SNMP ID:** 2.37.1.1

**Telnet path:** /Setup/WLAN-management/AP-configuration

### RADIUS profile

Here you enter the name of the RADIUS profile containing the information about the RADIUS server used for the authentication of the user data and the accounting of user activity.

**SNMP ID:** 2.37.1.1.35

**Telnet path:** /Setup/WLAN-Management/AP-Configuration/Networkprofiles

#### Possible values:

- Max. 16 characters

**Default:** Blank

## Enhancements to LANconfig

### Setting up the RADIUS profiles

In LANconfig, the settings for the RADIUS profiles in the WLAN controller are to be found under **WLAN Controller > Profiles > RADIUS profiles**.

**RADIUS profiles - Edit Entry**

Name:

Backup profile:

**Authentication server**

IP address:

Port:

Secret:   Show

Source address:

Protocol:

**Accounting server**

IP address:

Port:

Secret:   Show

Source address:

Protocol:

### Selecting a RADIUS profile for a logical WLAN

In LANconfig, selecting the RADIUS profile for a logical WLAN in the WLAN Controller is done with the menu item **WLAN Controller > Profiles > Logical WLAN networks**.

**Logical WLAN networks (SSIDs) - New Entry**

Logical WLAN network: activated

Name:

**Inheritance**

Inherit from entry:

Network name (SSID):

Connect SSID to:

VLAN mode:

VLAN ID:

Encryption:

Key 1/passphrase:   Show

RADIUS profile:

Allowed frequency bands:

AP standalone time:  minutes

MAC check activated

Suppress SSID broadcast:

RADIUS accounting activated

Allow data traffic between stations of this SSID

WPA version:

WPA1 session key type:

WPA2 session key type:

Basis rate:

Client Bridge Support:

Maximum count of clients:

Use long preamble for 802.11b

**802.11n**

Max. spatial streams:

Allow short guard interval

Use frame aggregation

## 13.17 Addition(s) to LCOS 8.82

### 13.17.1 Advanced ARP handling

As of LCOS version 8.82, access points can store more than one IP address per WLAN client.

#### Additions to the Status menu

##### ARP handling

This menu displays both IPv4 and IPv6 information about the WLAN clients detected in the WLAN cell.

---

 The access point can store multiple IP addresses per WLAN client in these tables, especially in IPv6 networks. If there are several IP addresses for each WLAN client, the entry in the WLAN station table (**Setup > WLAN > Station-Table**) points to the most recently identified IP address.

##### SNMP ID:

1.3.62

##### Telnet path:

**Status > WLAN**

##### ARP Table

This table contains IPv4 information about the WLAN clients detected in the WLAN cell.

##### SNMP ID:

1.3.62.1

##### Telnet path:

**Status > WLAN > ARP-Handling**

##### Address

Contains the stored IPv4 address of the WLAN client.

##### MAC address

Contains the associated MAC address of the WLAN client.

##### Interface

Contains the SSID with which the WLAN client is connected.

##### VLAN ID

Contains the VLAN ID on which the WLAN client is connected.

##### Age

Contains the time, in seconds, since the access point last identified the WLAN client.

---

 The access point only deletes entries in this table if it no longer detects the corresponding WLAN client in the WLAN cell.

---

 In this table, it is possible that the access point stores multiple IP addresses for a WLAN client (or several WLAN clients with the same IP address), in order to identify, for example, address conflicts.

**ND table**

This table contains IPv6 information about the WLAN clients detected in the WLAN cell.

**SNMP ID:**

1.3.62.2

**Telnet path:**

**Status > WLAN > ARP-Handling**

**Address**

Contains the stored IPv6 address of the WLAN client.

**MAC address**

Contains the associated MAC address of the WLAN client.

**Interface**

Contains the SSID with which the WLAN client is connected.

**VLAN ID**

Contains the VLAN ID on which the WLAN client is connected.

**Age**

Contains the time, in seconds, since the access point last identified the WLAN client.



The access point only deletes entries in this table if it no longer detects the corresponding WLAN client in the WLAN cell.



In this table, it is possible that the access point stores multiple IP addresses for a WLAN client (or several WLAN clients with the same IP address), in order to identify, for example, address conflicts.

**ARP requests answered**

This entry shows the number of ARP requests that the access point successfully and directly answered without the request having been previously sent to the WLAN cell.

**SNMP ID:**

1.3.62.11

**Telnet path:**

**Status > WLAN > ARP-Handling**

**ARP requests not answered**

This entry indicates the number of ARP requests not directly answered by the access point. Instead, the access point had to forward this request to the WLAN cell first.

**SNMP ID:**

1.3.62.12

**Telnet path:**

**Status > WLAN > ARP-Handling**

**ARP requests rejected**

This entry shows the number of ARP requests rejected by the access point. Reasons for this may include:

- The access point has already answered this request over a different interface.

- The access point has classified this request as an unnecessary ARP check.
- The request does not match the VLAN override of the WLAN client.

**SNMP ID:**

1.3.62.13

**Telnet path:****Status > WLAN > ARP-Handling****ND searches answered**

This entry shows the number of ND requests that the access point successfully and directly answered without the request having been previously sent to the WLAN cell.

**SNMP ID:**

1.3.62.14

**Telnet path:****Status > WLAN > ARP-Handling****ND searches not answered**

This entry indicates the number of ND requests not directly answered by the access point. Instead, the access point had to forward this request to the WLAN cell first.

**SNMP ID:**

1.3.62.15

**Telnet path:****Status > WLAN > ARP-Handling****ND searches rejected**

This entry shows the number of ND requests rejected by the access point. Reasons for this may include:

- The access point has already answered this request over a different interface.
- The access point has classified this request as a DAD query (Duplicate Address Detection).
- The request does not match the VLAN override of the WLAN client.

**SNMP ID:**

1.3.62.16

**Telnet path:****Status > WLAN > ARP-Handling****Delete values**

This action deletes all stored values in the ARP or ND tables.

**SNMP ID:**

1.3.62.99

**Telnet path:****Status > WLAN > ARP-Handling**

## 13.17.2 Multicast and broadcasts in cells can be switched off

According to the HotSpot 2.0 specification, as of LCOS version 8.82 it is possible to switch off multicasts and broadcasts in cells.

### Additions to the Setup menu

#### Transmit only unicasts

Multicast and broadcast transmissions within a WLAN cell cause a load on the bandwidth of the cell, especially since the WLAN clients often do not know how to handle these transmissions. The access point already intercepts a large part of the multicast and broadcast transmissions in the cell with ARP spoofing. With the restriction to unicast transmissions it filters out unnecessary IPv4 broadcasts from the requests, such as Bonjour or NetBIOS.

The suppression of multicast and broadcast transmissions is also a requirement from the HotSpot 2.0 specification.

#### SNMP ID:

2.23.20.1.19

#### Telnet path:

Telnet path: Setup > Interfaces > WLAN > Network

#### Possible values:

Yes

No

#### Default:

No

### Enhancements to LANconfig

#### Configuration of WLAN parameters

The settings for the cellular networks are made at various points in the configuration:

- Some parameters concern the physical WLAN interfaces. Some LANCOM models have just one WLAN interface (single radio access point), and others have a second WLAN module integrated (dual radio access point). The settings for the physical WLAN interfaces apply to all of the logical cellular networks supported by this module. These parameters include, for example, the transmission power of the antenna and the operating mode of the WLAN module (access point or client).
- Other parameters are only related to the Logical cellular networks, which are supported by a physical interface. These include, for example, the SSID or the activation of encryption, such as 802.11i with AES.
- A third group of parameters affect the wireless network operation, but are not significant only to WLANs. These include, for example, the protocol filter in the LAN bridge.



## The logical WLAN interfaces

Every physical WLAN interface can support up to eight different logical cellular networks (Multi-SSID). Parameters can be defined specifically for each of these networks, without the need of additional access points.

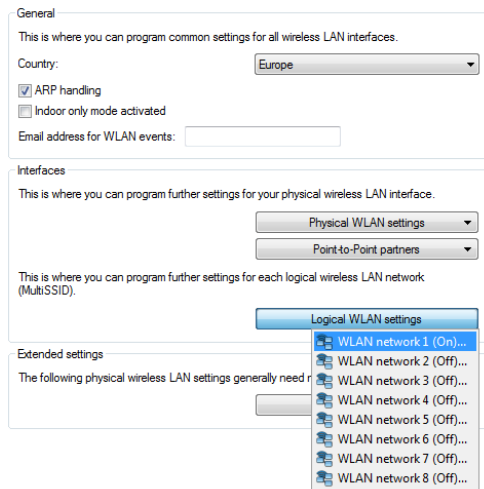

## Network settings

LANconfig:Wireless LAN > General > Logical WLAN settings > Network

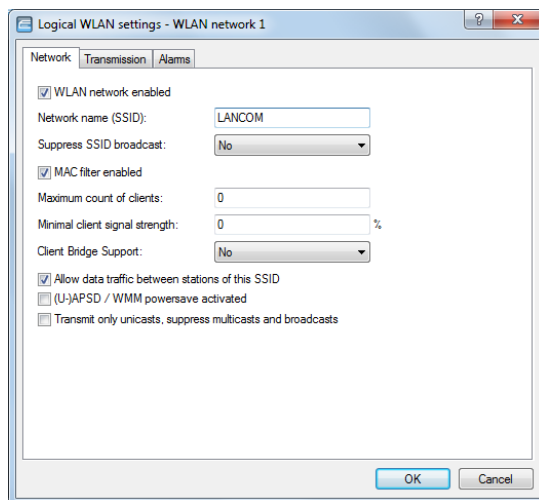

- ### WLAN network enabled

This switch enables or disables the corresponding logical WLAN.

- ### Network name (SSID)

Specify a unique SSID (the network name) for each of the required logical wireless LANs. Only network cards that have the same SSID can register with this wireless network.

- ### Suppress SSID broadcast

You can operate your wireless LAN either in public or private mode. A wireless LAN in public mode can be contacted by any mobile station in the area. Your wireless LAN is put into private mode by activating the closed network function. In this operation mode, mobile stations that do not know the network name (SSID) are excluded from taking part in the wireless LAN.

With the closed-network mode activated, WLAN clients that use an empty SSID or the SSID "ANY" are prevented from associating with your network.

The option **Suppress SSID broadcast** provides the following settings:

- **No:** The access point publishes the SSID of the cell. When a client sends a probe request with an empty or incorrect SSID, the access point responds with the SSID of the radio cell (public WLAN).
- **Yes:** The access point does not publish the SSID of the cell. When a client sends a probe request with an empty SSID, the device similarly responds with an empty SSID.
- **Tightened:** The access point does not publish the SSID of the cell. When a client sends a probe request with a blank or incorrect SSID, the device does not respond.

---

 Simply suppressing the SSID broadcast does not provide adequate protection: When legitimate WLAN clients associate with the access point, this transmits the SSID in plain text so that it is briefly visible to all clients in the WLAN network.

- **MAC filter enabled**

The MAC addresses of the clients that are allowed to associate with an access point are stored in the MAC filter list (**Wireless LAN > Stations > Stations**). The **MAC filter enabled** switch allows you to switch off the use of the MAC filter list for individual logical networks.

---

 Use of the MAC filter list is required for logical networks in which the clients register via LEPS with an individual passphrase. The passphrase used by LEPS is also entered into the MAC filter list. The access point always consults the MAC filter list for registrations with an individual passphrase, even if this option is deactivated here.

- **Maximum number of clients**

Here you set the maximum number of clients that may associate with this access point. Additional clients wanting to associate will be rejected by the access point.

- **Minimum client signal strength**

This value sets the threshold value in percent for the minimum signal strength for clients when logging on. If the client's signal strength is below this value, the access point stops sending probe responses and discards the client's requests.

A client with poor signal strength will not detect the access point and cannot associate with it. This ensures that the client has an optimized list of available access points, as those offering only a weak connection at the client's current position are not listed.

- **Client-bridge support**

Enable this option for an access point if you have enabled the client-bridge support for a client station in WLAN client mode ().

---

 The client-bridge mode operates between two LANCOM devices only.

- **Allow traffic between stations of this SSID**

Check this option if all stations logged on to this SSID are to be able to communicate with one another.

- **(U)APSD / WMM Power Save activated**

Enable this option to signal stations that the power saving function (U)APSD ([Un]scheduled Automatic Power Save Delivery) is supported.

(U)APSD is established in the 802.11e standard, and helps VoWLAN devices to increase their battery life. The related devices switch to power saving mode after login on a (U)APSD-capable access point. If the access point receives data packets for the related devices thereafter, it temporarily stores the data and waits until the VoWLAN device is available again. It then forwards the data. Afterwards, (U)APSD increases the latency time of the radio module, whereby it ultimately consumes less power. The individual rest periods may be so short that a VoWLAN device can still use the power saving function in the call state itself. However, the relevant devices must also support (U)APSD.

WMM (Wi-Fi Multimedia) Power Save is a power saving function of the Wi-Fi Alliance and is based on U-APSD. Certain LANCOM access points are WMM® Power Save CERTIFIED by the Wi-Fi Alliance.

- **Only transmit unicasts, suppress broadcast and multicasts**

Multicast and broadcast transmissions within a WLAN cell cause a load on the bandwidth of the cell, especially since the WLAN clients often do not know how to handle these transmissions. The access point already intercepts a large part of the multicast and broadcast transmissions in the cell with ARP spoofing. With the restriction to unicast transmissions it filters out unnecessary IPv4 broadcasts from the requests, such as Bonjour or NetBIOS.

The suppression of multicast and broadcast transmissions is also a requirement from the HotSpot 2.0 specification.

# 14 Public Spot

## 14.1 Introduction

This chapter provides answers to the following two questions:

- What is a Public Spot?
- Which functions and properties apply to the LANCOM Public Spot module?

### 14.1.1 What is a Public Spot?

Public Spots, also called hotspots, are places where users can connect their terminals – such as smartphones, tablet PCs or laptops – to a publicly accessible network. Normally, these networks provide connections to the Internet; however a Public Spot can also be limited to a local network in order to offer extra information to users visiting a museum or a trade show, for example. The term is usually synonymous to the devices with which the user can connect to the network, which is also why this manual does not differentiate between the location and the device.

Access via wireless LAN is widespread, however, it is also possible to access a Public Spot using a cabled LAN connection. The most popular demand for these services originally came from business travelers at airports, in hotels, or at other locations where their end devices require access to online content. The public rarely has access to modems, ISDN or broadband connections in areas like this. However, the recreational use of Public Spots by private persons has become very popular.

#### The solution: (W)LAN technology

Public Spot scenarios make use of the widespread (W)LAN technologies based on the internationally established IEEE 802.11/802.3 standards:

- Access via WLANs provides fast, uncomplicated network access by radio. The user only needs a WLAN adapter for their mobile device, which, for modern devices, is usually part of the standard equipment or can be inexpensively added, usually with a USB interface. The bandwidth is sufficient for most applications, even when multiple users are simultaneously logged in to a Public Spot.
- With automatic address allocation via DHCP, access via LAN is similarly uncomplicated: In this case, the user only needs a LAN adapter and a suitable cable for their end device, in order to connect their device to the Public Spot network at a wall socket.

However, when accessing via LAN the user loses mobility and uninterrupted flexibility. However, this access – assuming that a corresponding infrastructure is available – also provides stable network operation with the highest network load (for example, for multimedia content such as video-on-demand) and a higher number of users (for example, in a large hotel), where connections via WLAN may reach their limits sooner. It is also possible to add a Public Spot offering to an existing cable infrastructure (for example, in a college) with the use of a Public Spot via LAN.

#### Noteworthy issues of access using (W)LAN

It is difficult to employ a standard WLAN access point or LAN router as a Public Spot for two main reasons:

- User authentication is only possible by employing RADIUS/802.11x, so requiring the appropriate infrastructure and configuration.
- There is no facility for billing / accounting.

For this reason, the use of devices without the Public Spot function is not practical, since these devices are not able to separate and log the specific network usage of authorized and unauthorized users of publicly accessible networks.

## User authorization and authentication

As soon as an end device moves within range of an access point, the user can spontaneously establish a connection to this access point. The same is true for open LAN connections. However, the problem is that access should not be available to the public in general, but only to certain selected users. Setting up restrictions of this type is the task of a Public Spot.

For this purpose, a Public Spot must be in a position to control access to the WLAN on a user basis. For simple Public Spot installations, user data can be locally stored and managed in the router or access point – or alternatively on a WLAN controller. Instead, complex installations employ a direct database connection to a central authentication server in the interests of detailed accounting or direct management. Central servers of this type generally work with RADIUS technology.

## Accounting

If the Public Spot operator does not want to offer this service free of charge, connection data has to be collected and billed for each user. Typical methods include: Purchase of a limited amount of online time (pre-paid method), retrospective payment of consumed resources (credit payment), or unrestricted access until a certain time (e.g. checking out of a hotel).

For smaller Public Spot installations, accounting functions should be as simple as possible, and they should be implemented locally in the device. Larger installations offer the facilities for billing via an external RADIUS server. For each application scenario, the connection to an external system can also be implemented using a software interface which has access to the accounting data and can control the user authentication (e.g. hotel reservation systems).

## Logging

The operation of commercial telecommunications services is subject to national regulations. Certain information is to be recorded and presented to law enforcement agencies upon request.

The Public Spot module provides suitable functions for recording user data with RADIUS accounting and SYSLOG.

 Please note that operating a Public Spot (also referred to as a hotspot) can be subject to legal regulations in your country. Before installing a Public Spot, please inform yourself about any applicable regulations. You can also find information about this topic in the LANCOM techpaper "Public Spot" which is available at [www.lancom-systems.de/en/publications/products](http://www.lancom-systems.de/en/publications/products).

## 14.1.2 Possible application scenarios

### Guest access accounts in hotels

Wireless LAN makes it easier than ever for hotel operators to offer their guests convenient Internet access. Quick and easy to install, hotspot solutions from LANCOM enable guests to use their own laptop, tablet or smartphone to access the Internet via WLAN. Whether in the lobby, the conference room or in the hotel rooms—securely separated from the internal network, guest access can be provided anywhere it is desired.

The option LANCOM Public Spot PMS Accounting Plus is ideal for straightforward accounting: All Public Spot logins are automatically sent to the central PMS server where the hotel's accounting system is installed. In this way, guests can login to the hotspot using their room number and last name. For fee-based Internet access, the usage fees can be billed directly to the room. Needless to say, it is easy to set up free guest-access accounts in hotels, if desired.

- **Convenient setup and configuration** – a user-friendly setup and configuration wizard guarantees easy setup of the hotspot. For more details see the chapter [Basic installation of a Public Spot for simple scenarios](#) on page 911.
- **No access by unauthorized persons to internal data** – secure separation of the in-house and guest networks within a single infrastructure is ensured with VLAN or Layer 3 tunneling. Also, data can be securely encrypted on the wireless interface so that guests cannot penetrate the hotel network over the WLAN. For more details see the chapter [Virtualization and guest access via WLAN controller with VLAN](#) on page 992.
- **Simplified guest login on the WLAN** – The integrated Smart Ticket function ensures that the guest receives the login data for the Public Spot conveniently and automatically via text message (SMS) or e-mail. Alternatively, vouchers can also be printed out or guests can login with their room number and/or last name. For more details see the chapter [Alternative login methods](#) on page 946.

- **Simple billing of fee-based Internet access** – with the addition of the LANCOM Public Spot PMS Accounting Plus option, it is possible to connect to hotel accounting systems such as Micros Fidelio. For more details see the chapter *Interface for property management systems* on page 974.

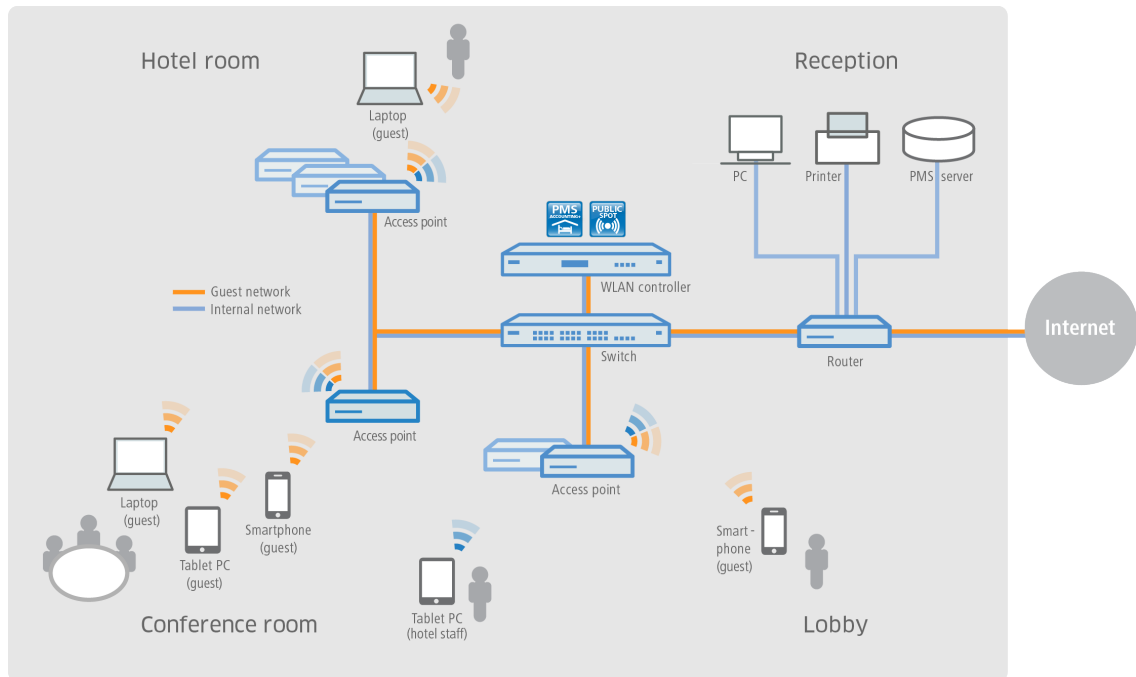

### Guest access in sport arenas

Stadiums that host large sporting events increasingly offer a range of modern services. For example, they should allow very large numbers of spectators to use Internet access with their own end devices, for example to view live content about the event, or to surf online. In order to offer spectators an Internet connection that is faster than the overloaded cellular networks, a promising solution is to offload the data to the stadium WLAN with the aid of LANCOM solutions. By connecting the clients to the stadium WLAN, the stadium operator has the possibility to create additional advertising space for sponsors—and thus additional sources of income. For example, the hotspot login page can be customized or sponsor websites can be invoked.

- **Multi-media fan experience** – with a WLAN Internet access, fans have the attractive option of watching current sports news live, and looking up information as well as watching replays.
- **New advertising spaces generate additional income** – additional, attractive advertising spaces can be made available to stadium operators by using the individual configuration options of the hotspot login page and also the configuration of pre-defined websites which do not require a login (walled garden function). For more details see the chapter *Open access networks (no login)* on page 933.

- **Convenient setup and configuration** – a user-friendly setup and configuration wizard guarantees easy setup of the hotspot. For more details see the chapter *Basic installation of a Public Spot for simple scenarios* on page 911.

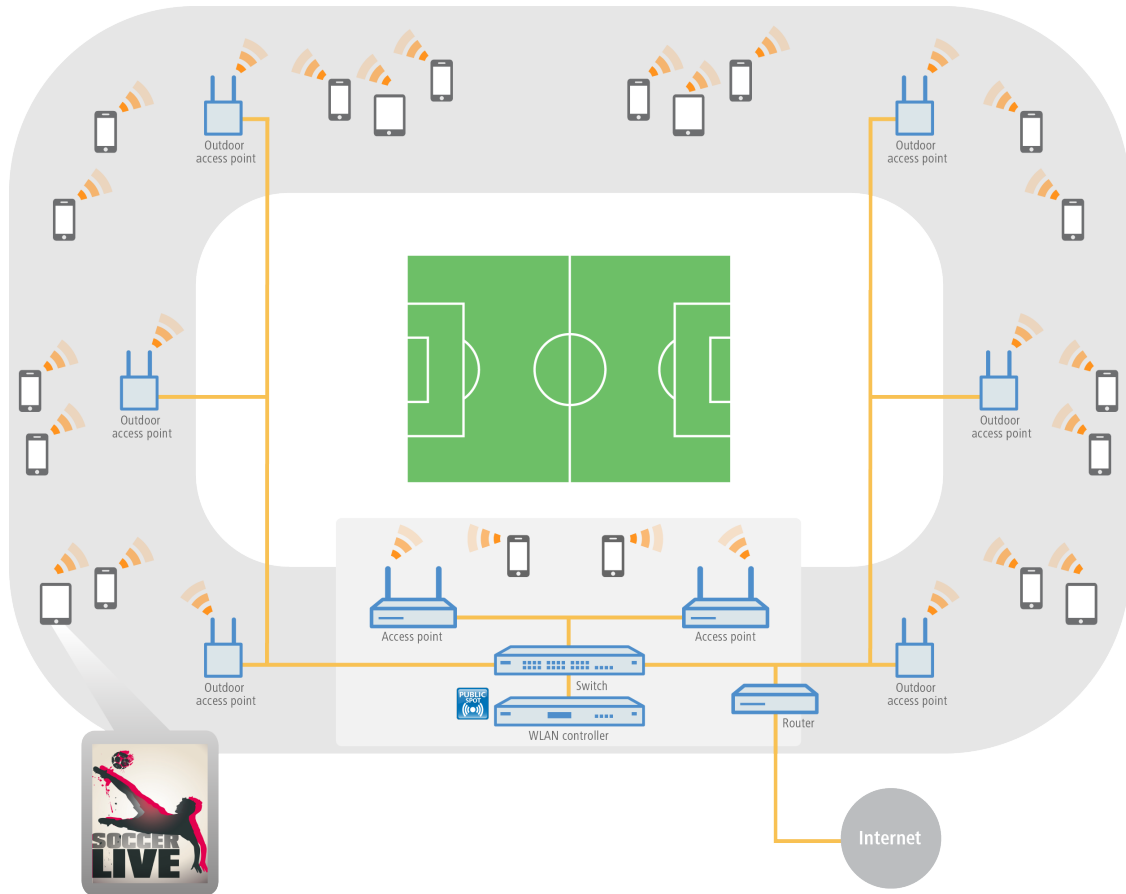

### Guest access at camping grounds

Camping grounds are exposed to the weather and are often quite large. Nevertheless, people vacationing at modern camping grounds expect to have the convenience of Internet access from their own laptop, tablet or smartphone. Whether in a tent, a camper or around the campfire, ubiquitously available Internet access is a real competitive advantage for camping ground operators.

With the robust, weather-proof outdoor devices from LANCOM and the LANCOM Public Spot option, even these demanding scenarios can be implemented with ease – and without the laborious and costly need to lay cables. For example, in administration buildings for camping grounds, a WLAN controller (incl. LANCOM Public Spot option) is connected to a LANCOM dual-radio outdoor access point. This sends the signal via point-to-point connections in the 5-GHz frequency band to further outdoor access points, which provide WLAN coverage in the 2.4-GHz frequency band to the desired areas—such as campsites or recreational areas for guests. The secure separation of the guest and administrative networks is assured throughout, thanks to VLAN assignment.

- **Online convenience without laying cables** – even in wide-open areas, guests can be connected to the Internet without a costly and complicated installation.
- **Convenient setup and configuration** – a user-friendly setup and configuration wizard guarantees easy setup of the hotspot. For more details see the chapter *Basic installation of a Public Spot for simple scenarios* on page 911.
- **Simplified guest access** – The integrated Smart Ticket function ensures that the client receives the login data for the Public Spot conveniently and automatically via text message (SMS) or e-mail. Or as an alternative, vouchers can be printed out. For more details see the chapter *Alternative login methods* on page 946.

- Reliable even in extreme conditions** – thanks to the robust IP66 outdoor housing and an extended temperature range, LANCOM outdoor devices are reliable and defy even extreme weather conditions from -33° to +70°C.

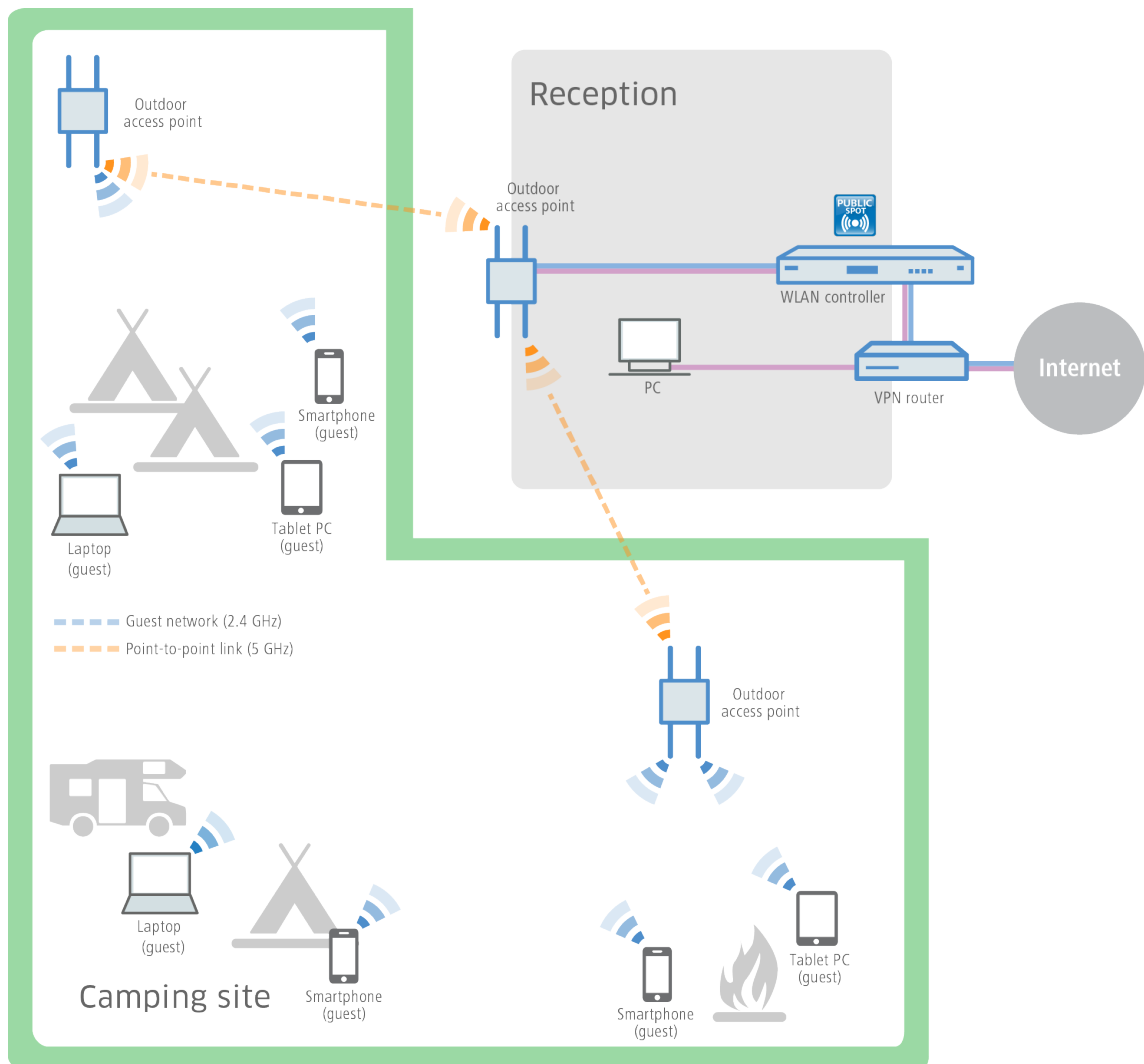

### Guest access in schools and universities

Researching at home, learning for tests, preparing classes, or interactive design: The potential of Internet usage for students and pupils as well as teachers and staff of modern schools and universities is indispensable today—including at isolated buildings, preferably wireless, and with the users' own end devices.

With the help of LANCOM WLAN solutions, this is easy to implement. By configuring separate networks, the Internet access of the pupils and students is securely separated from the administrative access. Thanks to dynamic VLAN access, the different user groups are assigned to the VLANs that are intended for them, using just one SSID. For example, only staff have access to the university servers. At the same time, school and university students have the convenience of an extensive WLAN guest access, which is so important these days. The authentication in the pupil and student networks (e.g., Eduroam) can be implemented with IEEE 802.1X. This makes it possible for guest students from partner universities to connect to the WLAN of the host university. And even conference guests can be provided with a temporary guest access by means of a voucher.

- Secure login for university affiliates** – professors, students and staff of universities can have access to the Internet and various online libraries over the securely encrypted WLAN.



- **No access by unauthorized persons to internal data** – secure separation of the administrative, students', and professors' and guests' networks within a single infrastructure is ensured with VLAN or Layer 3 tunneling. For more details see the chapter *Virtualization and guest access via WLAN controller with VLAN* on page 992.
- **No misuse of the network** – with the LANCOM Content Filter, professional, database-supported verification of websites is performed. Undesirable websites or web content can be made inaccessible to specified user groups.
- **Comfortable, cable-free Internet access** – even in large open areas, guests have Internet access with their WLAN-enabled end devices without a costly and complicated installation.

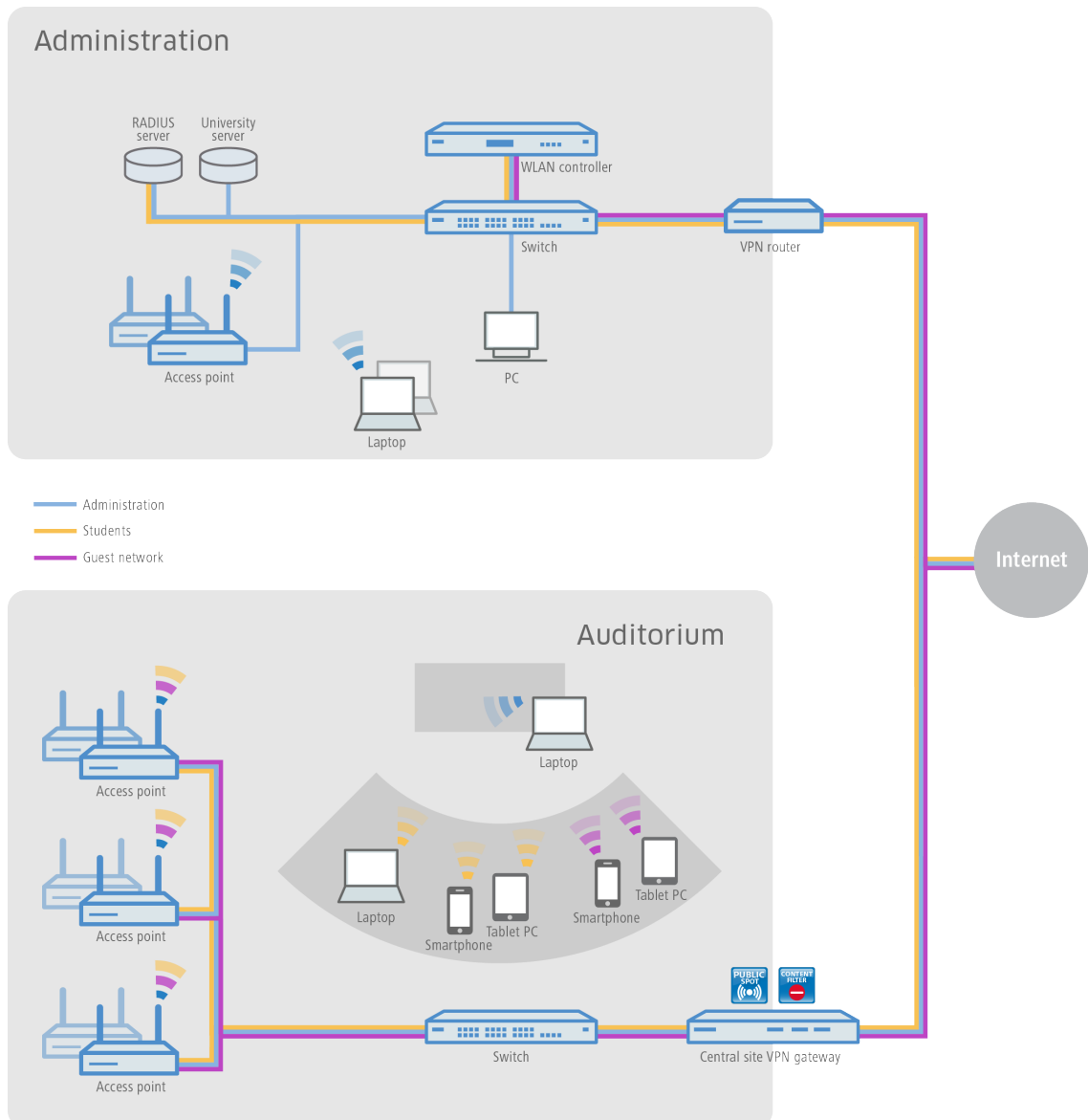

## Guest access in companies

At any company with a complex network structure, the flexibility and stability of Internet access is extremely important. Branch offices must have cross-site access to the company network, and home office employees also need access to e-mail accounts and databases. In addition, customers and visitors should be offered a separate guess access.

With devices from LANCOM and the LANCOM Public Spot option, these scenarios are easy to implement. The sites are connected using a VPN tunnel. Companies can provide access to the Internet for their external guests on their own mobile devices ("Bring Your Own Device") using a separate guest network in the company main office and even at networked branch offices. Access to the company's internal data is reserved for authorized employees only.

- **Secure separation of company and guest networks** – the secure separation of employee and guest networks within a single infrastructure is achieved by using VLAN or a Layer 3 tunnel. This keeps internal data safe from unauthorized access. For more details see the chapter [Virtualization and guest access via WLAN controller with VLAN](#) on page 992.
- **User-friendly setup and configuration** – a LANCOM WLAN controller allows different user profiles to be defined and configurations to be uploaded to the different WLAN devices – including those at remote sites.
- **Easy guest access** – using vouchers, it is a simple task for your reception desk to provide guests with login data for the Public Spot so that they can use their own mobile clients ("Bring Your Own Device"). In this way, only registered users have access to the Internet and e-mail.
- **No misuse of the network** – with the LANCOM Content Filter, professional, database-supported verification of websites is performed. Undesirable websites or web content can be made inaccessible to specified user groups.

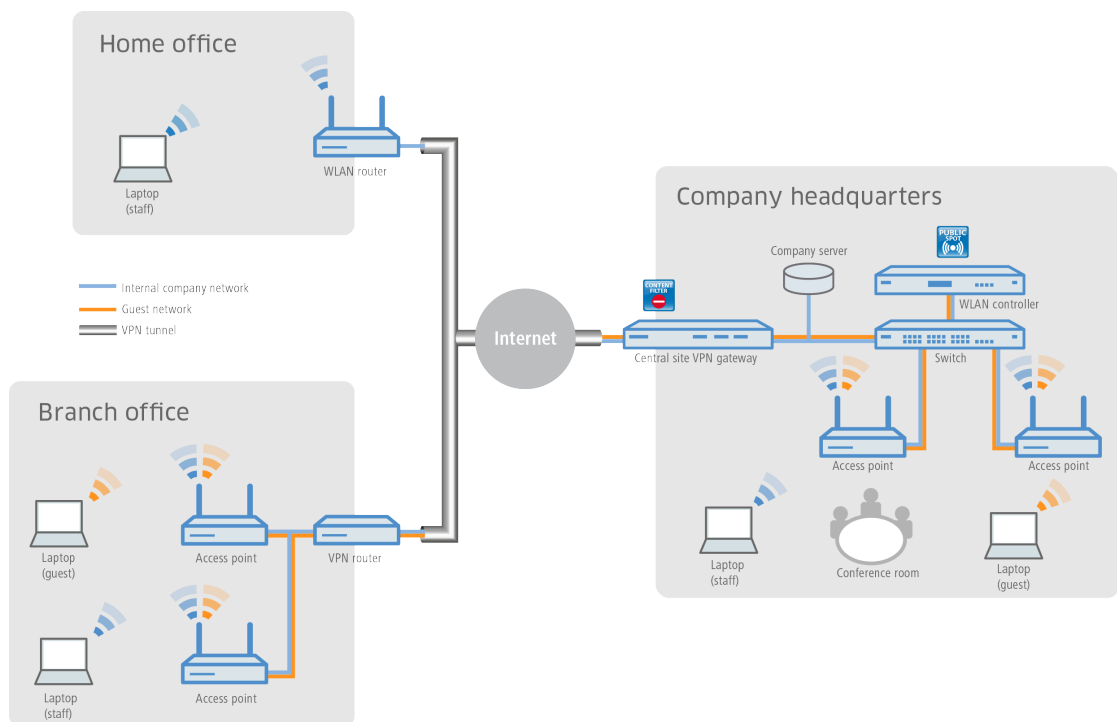

## Guest access for providers

With the solutions from LANCOM, it is very easy for Internet providers to offer their customers a network with guest access. The provider receives all necessary network products from one source, LANCOM, and manages the networks of its clients centrally and conveniently—without a technician on site.

For the implementation, LANCOM access points are installed behind a LANCOM VPN router at the site of the provider's client (for example, a hotel, hospital or business). An individually separated internal network is given direct Internet access. The guest access is provided over a secure VPN tunnel to the central-site VPN gateway at the provider, who can log incoming requests on their internal servers. With the LANCOM Content Filter, the provider can also limit or block access to undesirable or illegal websites for customer guest-access accounts.

- **Simple and central management and roll-out** – even without a technician on site, the provider can centrally monitor and configure the networks for the customer. For more details see the chapter [Basic installation of a Public Spot for simple scenarios](#) on page 911.
- **Different redirect options** – network separation means that the hotspot services can be designed and implemented in various ways. For example, services offered to end customers can be limited to hotspot administration only, or they can include full-service administration, whereby all data traffic from the end customer is forwarded to the provider via a tunnel.
- **Connection of proprietary AAA systems** – LANCOM provides different interfaces (RADIUS, XML, FIAS) which can be combined with proprietary AAA servers. Custom authentication and login to the hotspot, as well as accounting,

can be implemented specific to each provider. For more details see the chapter [Alternative login methods](#) on page 946.

- **Multi-provider support** – LANCOM devices are not locked into access via a specific provider. Hotspot service providers who cooperate with different providers can combine their software solutions over a variety of interfaces with the help of LANCOM devices. For more details see the chapter [Alternative login methods](#) on page 946.
- **No misuse of the network** – with the LANCOM Content Filter, professional, database-supported verification of websites is performed. Undesirable websites or web content can be made inaccessible to specified user groups.
- **Data offloading** – WLAN hotspots can provide effective relief for cellular networks by offloading data traffic to different infrastructures.

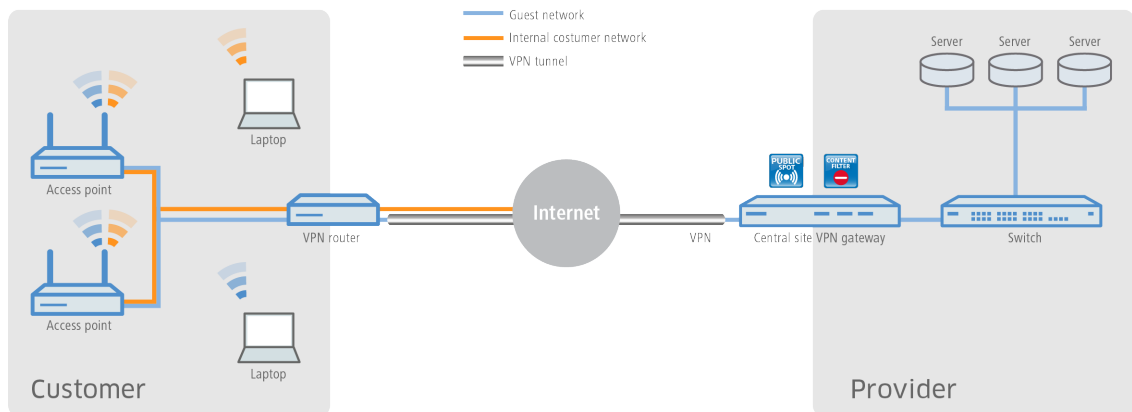

## Guest access in gastronomy

Providing guests in a modern restaurant or café with a hotspot can significantly increase the appeal of any location. With the WLAN solutions from LANCOM, guests benefit from a WLAN guest network in such a way that they can comfortably use the Internet with their mobile smartphones, tablet PCs or laptops—while being securely and completely separated from the internal administrative network. For a significant increase in efficiency in work processes, wait staff also have the option of taking orders with the help of a WLAN-enabled hand-held device, and transmitting the order directly to the checkout system, kitchen, or drink serving station. Needless to say, WLAN access for the guests and for taking orders can also be made available on the patio or outdoor areas of the restaurant, since a robust LANCOM outdoor access point is ideal for outdoor areas.

- **Customizable and flexible creative leeway** – whether with proprietary logos, texts or images—the welcome page of the Public Spot can be easily tailored to your own requirements. Even displaying pre-defined websites is possible (walled garden feature), so that, for example, the menu of the restaurant or its own website is shown to the guest without a prior login to the hotspot by the guest. For more details see the chapter [Default and customized authentication pages](#) on page 979.
- **No access by unauthorized persons to internal data** – secure separation of the networks within a single infrastructure is ensured with VLAN or Layer 3 tunneling. For more details see the chapter [Virtualization and guest access via WLAN controller with VLAN](#) on page 992.
- **Convenient setup and configuration** – a user-friendly setup and configuration wizard guarantees the easy setup of hotspots. For more details see the chapter [Basic installation of a Public Spot for simple scenarios](#) on page 911.

- Simplified guest access** – The integrated Smart Ticket function ensures that guests receive their login data for the Public Spot conveniently and automatically via text message (SMS) or e-mail. Or as an alternative, vouchers can be printed out. For more details see the chapter *Alternative login methods* on page 946.

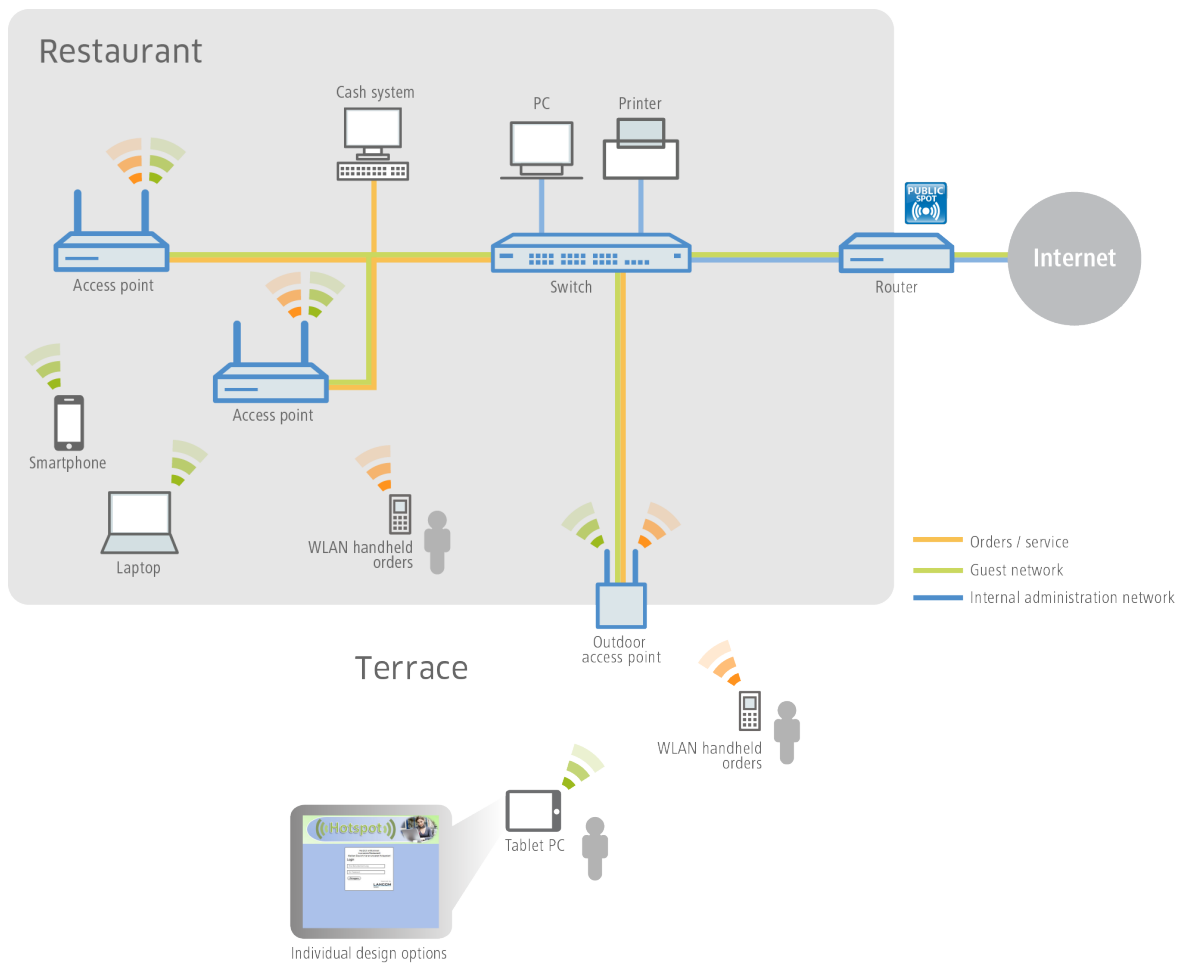

### 14.1.3 Overview of the Public Spot module

The demands placed on devices operating Public Spots are as varied as the environments they are employed in. A Public Spot offers various functions which are described in more detail in the following sections.

#### Open User Authentication (OUA)

Open User Authentication (OUA) is a method developed by LANCOM Systems. It provides Web-based authentication by means of an online form and is ideal for Public Spot installations.

#### Typical procedure for an online session with OUA

- The user of a W(LAN)-enabled end device is within reach of an access point or a network outlet in a Public Spot mode.
  - WLAN: After system startup, the WLAN adapter automatically logs on to the appropriate access point.
  - LAN: After system startup the user connects to the network with a suitable cable and is assigned an address by the DHCP server.

Internet access or the use of chargeable services is not yet possible at this stage.

- The user starts a web browser. The device offering the Public Spot service automatically directs the user to the login page of the Public Spot. This page provides detailed information on using the services.

Generally, the user purchases a voucher with login data that grants a limited amount of access time. Other login methods are also possible, such as login after confirming the provider's terms of use or independently requesting login data via e-mail or a text message (SMS).

3. In the case of a login using a voucher, the user enters his login data (username and password) on the login page. Depending on the configuration, the RADIUS server on the device (internal) or an external one checks the login data that was entered. If the login is successful, the user gains access to the Public Spot. Otherwise an error message will be displayed. If a prepaid model is employed, i.e. access is to be granted for a limited period of time only, then the RADIUS server additionally informs the Public Spot about the user's time credit.
4. The user can log off from the Public Spot at any time. The Public Spot can terminate a session itself if the time credit has expired, if a specified expiry date is reached, or if contact is lost for an extended period.

During and at the end of a session the Public Spot provides the user with an overview of the session data. If required, the Public Spot can simultaneously transmit all important accounting information to the RADIUS server. This can be the device's internal server or an external server.

### OUA can be employed universally

The big advantage of the OUA method is that it is completely based on standard protocols. This guarantees that OUA can be operated universally. It works with any (W)LAN adapter, can be seamlessly integrated in existing network infrastructures, and makes it possible to implement additional features, for example, when the WLAN is between cells during roaming.

## Security in the (W)LAN

Wireless LANs are potentially a significant security risk. Public Spots present similar risks to the operator and users.

### Security for the operator

Operators of Public Spots are primarily interested in the security of their own network infrastructure. A Public Spot module provides operators with a range of security technologies and methods:

- **Multi-SSID (only WLAN), VLAN and virtual routers**
  - The safe separation of public access can be achieved using one or more different radio cells for an access point (Multi-SSID).
  - VLAN technology can separate public access from the private network of the operator.
  - Virtual routing technology ARF (Advanced Routing and Forwarding) from LANCOM supplies one SSID with its own security and QoS settings and only specific destinations are routed on it.

This ensures that guest access over a Public Spot is securely and effectively separated from the productive network, even though they share the same infrastructure. The device's internal firewall can, for example, limit the available bandwidth in the WAN to max. 50 %, and access can be restricted to web pages (HTTP, port 80) and name resolutions (UDP 53).

---

 Further information on Multi-SSID, VLANs and ARF is available in the LCOS Reference Manual.

- **Traffic limit**

To avoid denial-of-service (DoS) and brute-force attacks on the Public Spot you can restrict the permissible data transfer for non-authenticated Public Spot participants to a harmless volume.

- **Locking access to the configuration**

You can lock access from your Public Spot network to device configurations (e.g., your access points, WLAN controllers or routers) so that access to configurations is only possible using other specified management interfaces.

### Security for the user

The primary security concern for users of Public Spots is the confidentiality of their data. Users are also interested in security of user data to avoid misuse. Users are protected by the following security technologies:

- **Intra-cell blocking** (WLAN Only)

Prevent communication between the WLAN clients in your Public Spot network. Along with the user's existing security mechanisms, this measure helps to prevent unauthorized access to the resources of your Public Spot users.

- **Encryption during the login phase**

If you have a digital certificate, you can load it on your device in order to secure usernames and passwords using an encrypted HTTPS method. The digital certificate should be signed by a recognized public authority so that browsers classify it as trustworthy and do not display security errors to the users. If there is no certificate, data is sent unencrypted.

 The certificate merely secures the login process, as the data within a Public Spot network are normally not encrypted. This is true for LAN as well as WLAN connections. If your users wish to secure their regular data traffic as well, they will have to use their own encryption methods.

An exception to this are the WLAN connections via HotSpot 2.0: Since the HotSpot 2.0 standard is based on WPA2 (802.1X/802.11i), EAP and 802.11u, data packets are always encrypted for transmission, both for authentication and during the session.

LANCOM Systems strongly recommends that sensitive user data should only ever be transferred via encrypted connections, such as the IPSec-based VPN tunnel with the LANCOM Advanced VPN Client or over normal encrypted data connections based on HTTPS. In addition to this, Public Spot users should ensure that a personal firewall is active on their end devices.

### Setup wizard for Public Spots

The **Setup Public Spot** wizard helps you to setup and perform the initial configuration of your Public Spot. You can set up a functional Public Spot network with just a few clicks. The wizard groups the necessary settings together (e.g. assign an interface, choose an IP range, specify the access format and login procedure, logging) and offers you the option to create an administrator with limited rights who can only create and manage Public Spot users.

### Wizard for creating and managing users

Using the setup wizard **Create Public Spot account** you can use WEBconfig to create temporary accesses to the Public Spot network with just a few clicks of the mouse. In the simplest case, you only need to enter the duration of access, the wizard assigns the username and password automatically and stores the credentials in the user database of the internal RADIUS server. The user receives a printed, personalized voucher, which the user can use to login to the Public Spot network for the specified period.

The setup wizard **Manage Public Spot account** displays all registered Public-Spot user accounts in a table on a web page. With just one click you have the most important data for your users on one screen, and you can easily view the login status, information about login data and corresponding validity periods, extend a voucher, or delete a user account.

## 14.2 Setup and operation

This chapter contains the main information required for setting up and operating a Public Spot.

- **1) step: Basic configuration**

First, we describe the basic configuration. After completing the basic configuration, the Public Spot is operational and pre-configured for a simple application scenario (login using voucher).

- **2) step: Security settings**

This chapter describes in detail the security settings that impede attacks on your Public Spot network and promote stable operation. If you have not already made these settings during previous setup steps, you should pay close attention to the following pages.

### ■ 3) step: Extended functions and settings

Finally, we review the wide variety of available extended functions and settings. Detailed descriptions inform you on how to individually adapt your device to its task and its environment. In addition, this chapter informs you on how to keep an overview of the status and activities of your Public Spot.

- ⓘ Please note that operating a Public Spot (also referred to as a hotspot) can be subject to legal regulations in your country. Before installing a Public Spot, please inform yourself about any applicable regulations. You can also find information about this topic in the LANCOM techpaper "Public Spot" which is available at [www.lancom-systems.de/en/publications/products](http://www.lancom-systems.de/en/publications/products).

## 14.2.1 Basic configuration

The instructions for the basic settings are divided into several separate sections:

- The first section describes the setup of an operational Public Spot using a Wireless Router as an example.

ⓘ To set up a Public Spot for a simple application scenario, you can start the corresponding wizard, which assists you in configuring the Public Spot.

- The second section describes the configuration of the default values for the user wizard with which new employees can easily create and manage new Public Spot users without the need for general administrator rights. This also includes creating a limited access account with which your employees can access this wizard only.
- The third section describes user administration on the local RADIUS server, either using the user wizard or manually with LANconfig.

To a certain extent these sections are dependent on one another, and ideally you should work through them in sequence.

### Basic installation of a Public Spot for simple scenarios

#### Installation using the setup wizards

The following tutorial describes how to use LANconfig's Public Spot setup wizard to perform a basic Public Spot installation.

ⓘ The wizard for the basic configuration of the Public Spot shows different dialogs depending on the device type and your previous choices. This tutorial is only an example.

1. To do this, start LANconfig and select the device for which you want to set up the Public Spot, for example, a LANCOM access point.
2. Start the Setup Wizard with **Device > Setup wizard**, select the action **Setup Public Spot** and then click **Next**.



## 14 Public Spot

3. If you want the Public Spot to be available over WLAN, enable the corresponding option and then click **Next**.

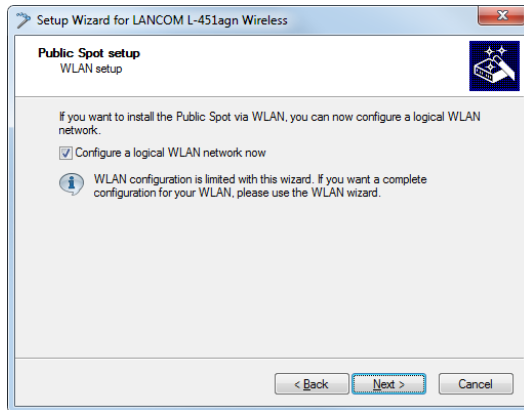

4. Select the logical interface from the drop-down menu which the Public Spot should offer (e.g., WLAN-1), and enter a descriptive name for the wireless network (SSID). Click on **Next**.

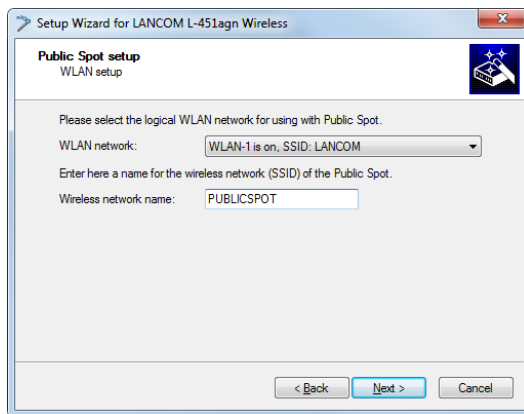

5. Assign the IP address and netmask to the device that your Public Spot network should specify and click **Next**. The Public Spot module has its own address on your network, which is independent from the address that you assigned to your device. For example, if you have a 192.168.0.0/24 network set up and your device has the IP address 192.168.2.1, you can assign the IP address 192.168.3.1 and the subnet mask 255.255.255.0, as long as this IP address has not already been used elsewhere.

If you want to separate the Public Spot network from internal networks for security reasons, make sure that the corresponding option is enabled.

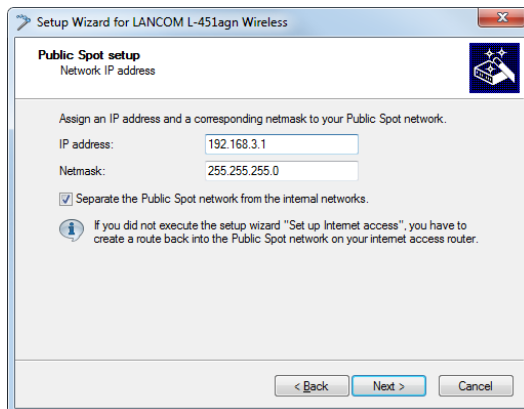



- ! If your device is not directly connected to the Internet and you have a different address range for your Public Spot, you must set up a return route to your Public Spot network on your Internet gateway. If there is no return route, Public Spot users will see an HTTP error after they have successfully authenticated.

Please find the directions on how to set up a return route, in the documentation for your Internet gateway. If it is a LANCOM device, you can configure it under **IP router > Routing > IPv4 routing table**. To do this, create a new entry and enter the network address of your Public Spot network under **IP Address** and under **Router** enter the address of the Public Spot in your local network.

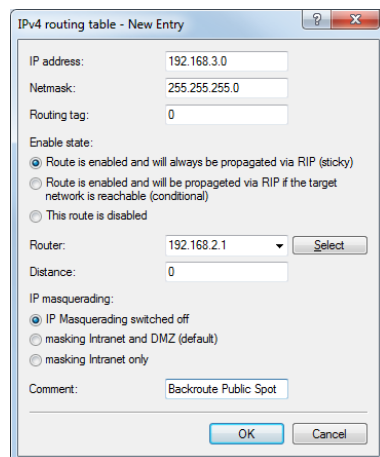

6. Specify which login data your users are to use to login to the Public Spot. Also, you can optionally add customized text to the login page. To continue, click on **Next**.

You can either give each user their own login data or set up a general account that all users use to access the Public Spot. If you issue vouchers later and would like to set up permanent user accounts, select the option **Individual tickets per guest**.

The login text is a customized text entered in HTML format, which appears on the login page inside the box on the registration form. You can manually add or edit this text at a later time (see section [Customized text on the login page](#) on page 981).

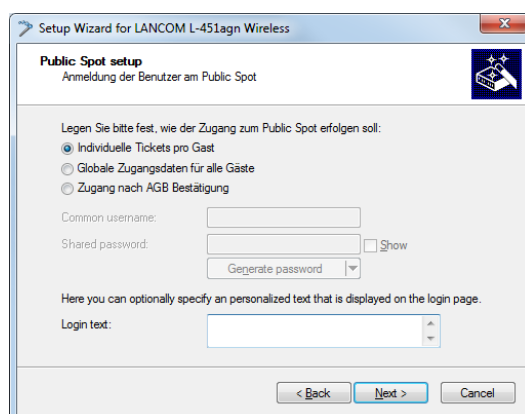

7. If necessary, create an administrator with limited rights who can use the setup wizards in WEBconfig to create and manage Public Spot users. To continue, click on **Next**.

This type of administrator is useful when you want your employees to be able to manage user accounts themselves without the help of a device administrator. The right to create new accounts in WEBconfig enables the Create Public Spot account wizard, and administrator rights enable the Manage Public Spot account wizard.

Using the user creation wizard **Create Public Spot account**, the administrator has the option of creating time-limited accounts for Public Spot users and print the corresponding login data on a voucher.

The **Manage Public Spot accounts** wizard enable the administrator to manage the users. The administrator can extend or reduce the validity period of access, or completely delete a specific user account. In addition, the administrator can call up information about the user account using the wizard, such as the password in plain text, the authentication status, the IP address, the sent/received data volume or any restrictions that apply to the account.

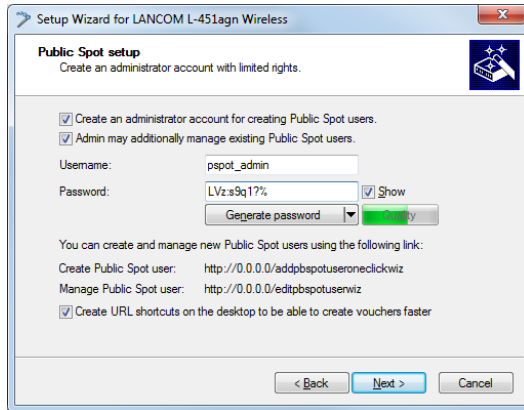

! Make sure that the password you create is secure. The Setup Wizard will check the quality of the password you enter. For passwords that are not secure the input field appears in red, when it is more secure it changes to yellow, and when it is very secure the background turns green.

8. Select the procedure for user login. To continue, click on **Next**.

You can select **HTTPS** or **HTTP** in the drop-down list. Using a connection with HTTPS provides a secure connection for Public Spot users.

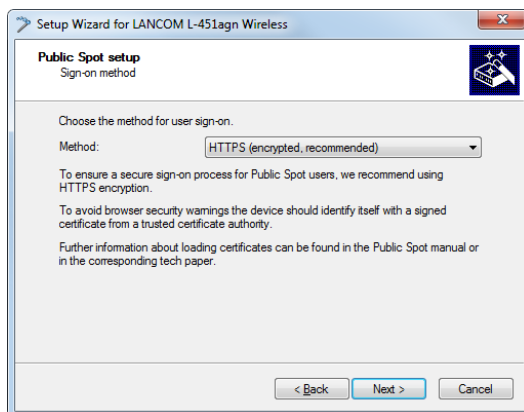

9. Determine whether automatic re-login is allowed for all Public-Spot users, and the maximum absence that is allowed before the user must login again on the Public Spot webpage. To continue, click on **Next**.

The **Automatic re-login** option is a convenience option that allows the Public Spot to automatically authenticate known users or devices. However, if known devices are to be recognized exclusively from the MAC address of the

network adapter, the fact that MAC addresses can be falsified represents a potential security risk. For this reason this option is disabled by default.

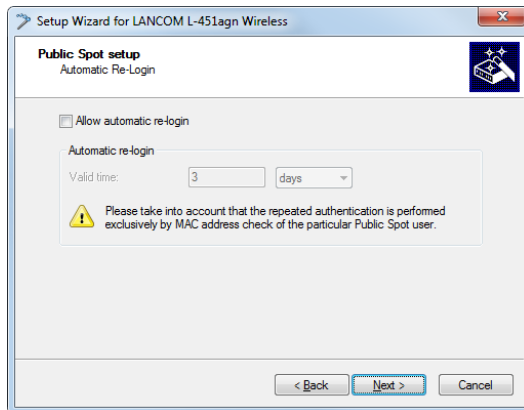

10. If needed, enable logging of logins and logouts for Public Spot users in the internal SYSLOG storage of your device. To continue, click on **Next**.

Since the logs comply with country-specific regulations, this option is disabled by default. Before enabling this function, you need to determine what the data protection regulations are for your country in order to avoid any legal issues.

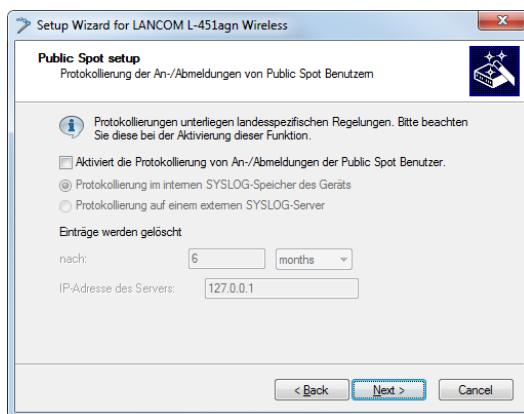

11. Save your changes if necessary.

Before you save the configuration to your device, you have the option of saving the configuration locally on your PC, sending it by e-mail, or printing a summary.

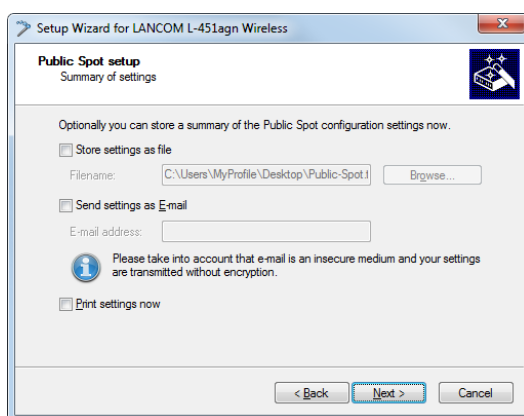

12. The click **Next** and finally **Finish** to complete the basic installation of the Public Spot. The Setup Wizard will now send the settings to the device.

That's it! You have completed configuration of your Public Spot module! Now, if you come within range of a Public Spot with a WLAN-capable device, the device can find the SSID that you set up as a public network and login to it.

### Manual installation

The following configuration steps show you how to manually setup a Public Spot for simple scenarios. For the application scenario described here, you enable the Public Spot on an interface over which there is no other data traffic other than the Public Spot traffic – where Public Spot and normal WLAN users do not share the same network (dedicated SSID).

**!** This tutorial is only an example. Depending on the device type (access point, router, WLAN controller, etc.) or complexity of the network configuration (e.g., use of VLAN or ARF), different or additional steps may be required for setting up a Public Spot. Since this type of network configuration can be highly customized, this tutorial concentrates specifically on a simple example, so that you can adapt the steps as needed.

1. To do this, start LANconfig and select the device for which you want to set up the Public Spot, for example, a LANCOM access point. Next, open the configuration menu for the device.
2. Check that the time is correct.

To check the certificates and correctly record and bill session data, it is important for the Public Spot's time setting to be accurate. First make settings such as time zone and time changes (summer and standard time):

- LANconfig: **Date/time > General**

**!** In order to ensure that the time of the Public Spot remains correct, the device should be set up as an NTP client. Enter the time server that is necessary for that under **Date/Time > Synchronization > Time server**. Open the "Add" window to show a list of possible server addresses.

3. Select the interfaces for the Public Spot operation.

Here you activate the interfaces which will be available to registered users. Along with the logical WLAN interfaces which Public Spot users directly login to, the logical LAN interfaces (LAN-1, etc.), and the point-to-point connections (P2P-1, etc.) can also be selected. When connected via the LAN or P2P interface, you can integrate additional access points into a LANCOM Wireless router Public Spot. For an access point select, for example, the logical WLAN interface **WLAN-1**.

- LANconfig: **Public Spot > Server > Interfaces**

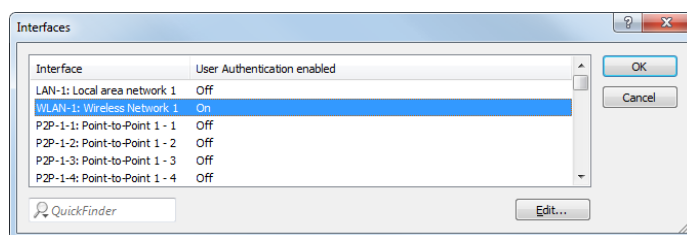

By activating the authentication for a WLAN interface, you automatically release the associated SSID for the Public Spot operation.

**!** On a LANCOM WLAN controller you can enable certain Ethernet interfaces for the Public Spot. In this manner you can also set up selective restrictions for certain VLANs.

4. Access to your device from the Public Spot network should be restricted to the authentication pages. If you do not restrict access, Public Spot users will be able to access the configuration interface of your device (WEBconfig). For security reasons you should not permit this.

- LANconfig: **Public Spot > Server > WEBconfig access by Public Spot interfaces limited to authentication pages**

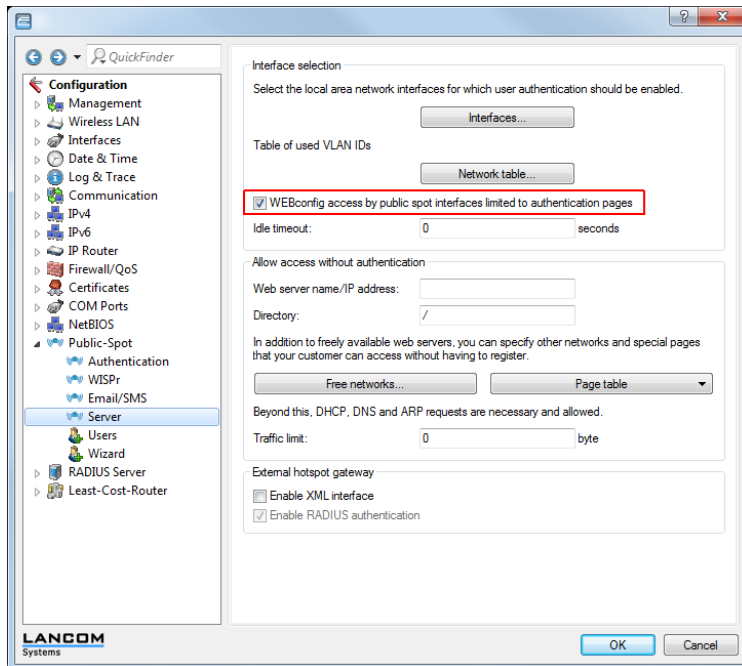

- Disconnect the interface which is to be used for Public Spot operations from the other network traffic. In order for end devices to be able to communicate with each other using different interfaces of a LANCOM (e.g., between LAN-1 and WLAN-1), these interfaces are logically connected to each other (bridged) within your device. However, in a Public Spot scenario this type of bridging may not be desirable for security reasons. In order to disconnect the communication between an interface (e.g., WLAN-1) assigned to a Public Spot and the rest of the network, you have to remove bridging. In the **Port table** set the **Bridge group** for the respective interface to **none**.

- LANconfig: **Interfaces > LAN > Port table**

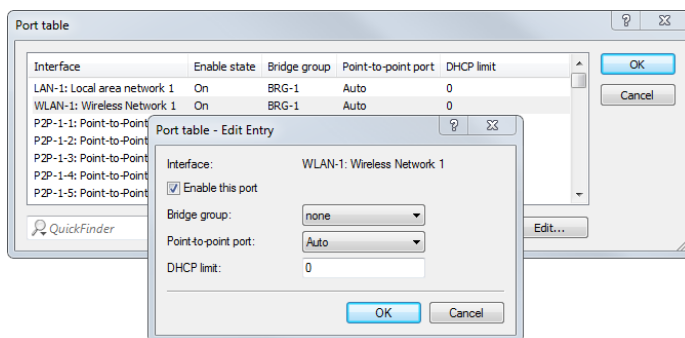

- Enable the WLAN for the Public Spot.

This setting does not affect: LANCOM routers, WLAN controllers, central-site gateways.

Activate the logical WLAN which you enabled for the Public Spot login and assign a descriptive name to this network (SSID).

- LANconfig: **Wireless LAN > General > Logical WLAN settings > WLAN network <number> > Network**

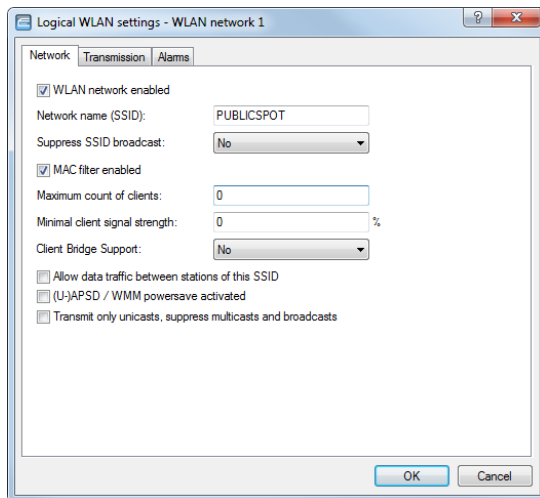

- Assign the IP address and netmask to the device that your Public Spot network should specify. The Public Spot module has its own address on your network, which is independent from the address that you assigned to your device. For example, if you have a 192.168.0.0/24 network set up and your device has the IP address 192.168.2.1, you can assign the IP address 192.168.3.1 and the subnet mask 255.255.255.0, as long as this IP address has not already been used elsewhere. Select the interface that you chose under **Interface assignment** e.g., WLAN-1.

- LANconfig: **IPv4 > General > IP networks**

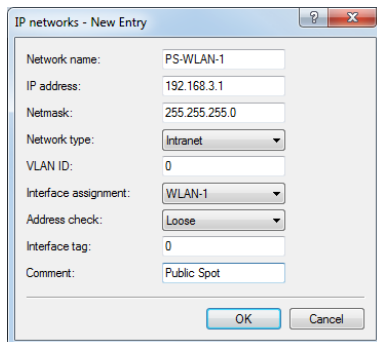

- ⓘ If your device is not directly connected to the Internet and you have a different address range for your Public Spot, you must set up a return route to your Public Spot network on your Internet gateway. If there is no return route, Public Spot users will see an HTTP error after they have successfully authenticated.

Please find the directions on how to set up a return route, in the documentation for your Internet gateway. If it is a LANCOM device, you can configure it under **IP router > Routing > IPv4 routing table**. To do this,

create a new entry and enter the network address of your Public Spot network under **IP Address** and under **Router** enter the address of the Public Spot in your local network.

IPv4 routing table - New Entry

IP address: 192.168.3.0  
 Netmask: 255.255.255.0  
 Routing tag: 0

Enable state:  
 Route is enabled and will always be propagated via RIP (sticky)  
 Route is enabled and will be propagated via RIP if the target network is reachable (conditional)  
 This route is disabled

Router: 192.168.2.1 [Select]  
 Distance: 0

IP masquerading:  
 IP Masquerading switched off  
 masking Intranet and DMZ (default)  
 masking Intranet only

Comment: Backroute Public Spot

OK Cancel

- Configure the DHCP server settings for the Public Spot network.  
 Since the device has an IP network that is independent from the network where it is located, you must configure a DHCP server for this network. For the previously set up IP network (e.g., PS-WLAN-1), set the value for **DHCP server enabled** to **automatic**.

- LANconfig: IPv4 > DHCPv4 > DHCP networks

DHCP networks - New Entry

Network name: PS-WLAN-1 [Select]  
 DHCP server enabled: Auto

Evaluate broadcast bit  
 DHCP cluster

Forwarding of DHCP queries

1. server address: 0.0.0.0  
 2. server address: 0.0.0.0  
 3. server address: 0.0.0.0  
 4. server address: 0.0.0.0

Place server replies in intermediate storage  
 Adapt server replies to the local network

Addresses for DHCP clients

First address: 0.0.0.0  
 Last address: 0.0.0.0  
 Netmask: 0.0.0.0  
 Broadcast: 0.0.0.0  
 Default gateway: 0.0.0.0

Name server addresses

Primary DNS: 0.0.0.0  
 Secondary DNS: 0.0.0.0  
 Primary NBNS: 0.0.0.0  
 Secondary NBNS: 0.0.0.0

OK Cancel

- Disable the encryption for the interface that you are using for the Public Spot.

This setting does not affect: LANCOM routers, WLAN controllers, central-site gateways.

Encryption for all logical WLANs is enabled by default. In Public Spot applications, the payload data between the WLAN clients and the access point are usually transmitted unencrypted. For this reason, disable encryption for the logical WLAN which you previously set up for the Public Spot login.

- LANconfig: **Wireless LAN > 802.11i/WEP > WPA or Private WEP settings**

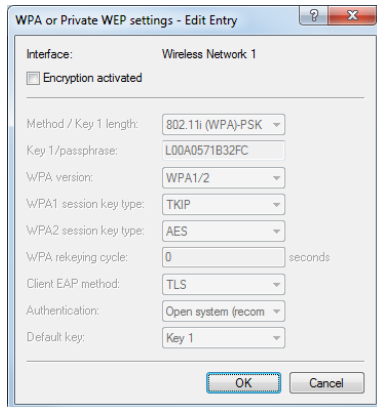

- Select the authentication mode and the protocol used for the user login.

The authentication method that you select determines the information which users of the Public Spot WLAN must enter when logging in. Select **Authenticate with name and password** to allow your users the option to login with an individual username and password that you have previously assigned them. This setting also allows you to quickly provide Hotspot access to your guests using vouchers (tickets).

Use **HTTPS** as the protocol in order to be able to send encrypted login data to your users during login.

- LANconfig: **Public Spot > Authentication > Authentication mode**

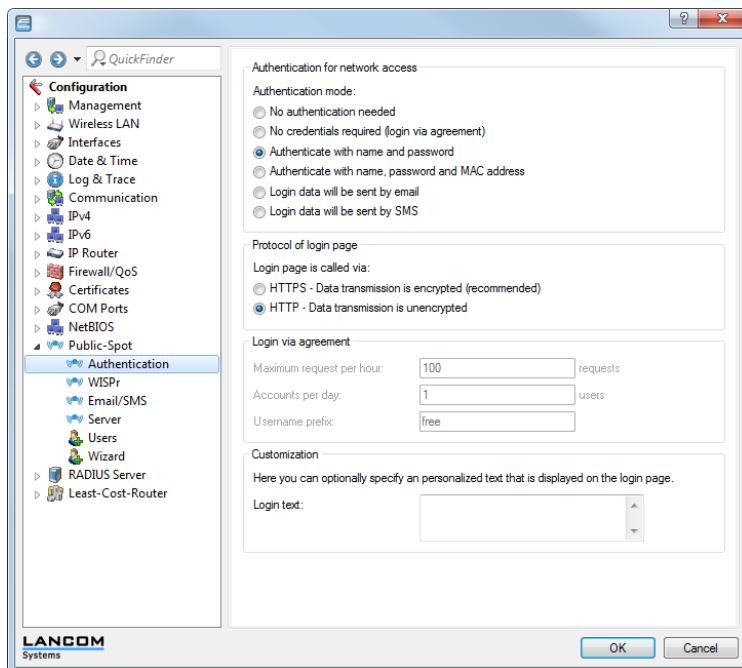

- Specify the internal RADIUS server as the server responsible for user administration and accounting. To do this, enter the **Authentication port1 . 812** and **Accounting port1 . 813**.

You store Public Spot access accounts in the user database on the device's own RADIUS server. In order to use Public Spot access accounts, you **must** configure the RADIUS server and the Public Spot module to use the RADIUS server.



- LANconfig: **RADIUS server > General**

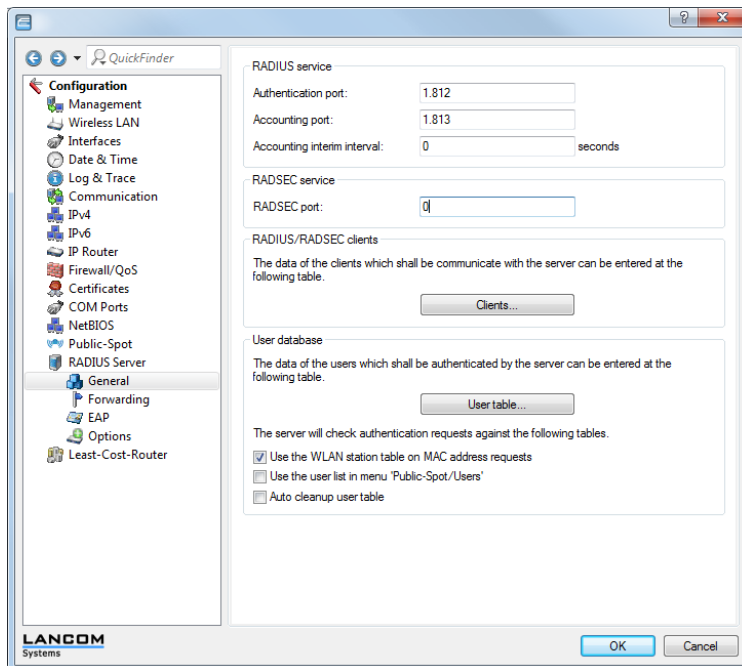

- Create an entry for the internal RADIUS server in the list of authentication servers of the Public Spot. Under **Auth. server IP address** and **Acc. server IP address** enter the loopback address 127.0.0.1. Use the **Auth. server port** and **Acc. server port** used for the authentication port and accounting port in the previous settings. The list entry is necessary in order for the Public Spot to recognize the address of the RADIUS server and so that it can authenticate Public Spot access on the internal RADIUS server.

- LANconfig: **Public Spot > Users > Authentication servers**

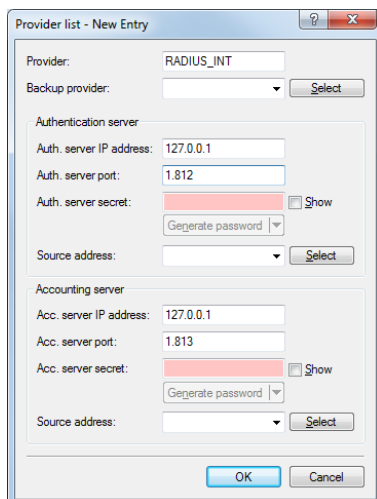

- Set up filter rules in the Public Spot's firewall to secure your local network. In each case, create an "accept" rule (for example, ALLOW\_PS-WLAN-1) and a "reject" rule (for example, DENY\_PS-WLAN-1). You use the accept rule when devices are to be able to send DNS requests from the Public Spot network to all local networks, e.g., your local intranet. On the other hand, with a reject rule you generally block all access or requests from the Public Spot network to your local network. The order – accept before reject – is essential, since the firewall applies rules from top to bottom of the list.

- LANconfig: **Firewall/QoS > IPv4 Rules > Rules...**

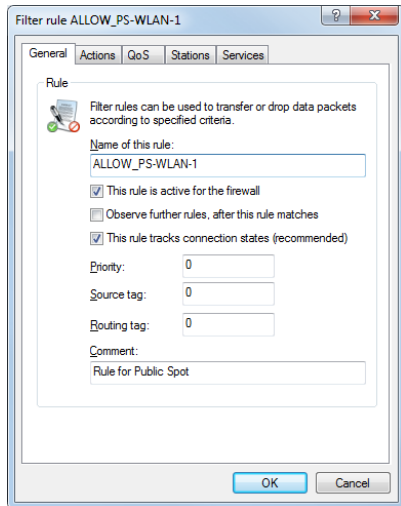
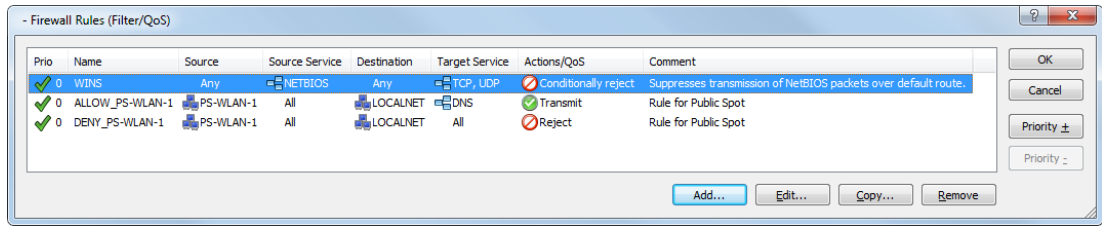

- "Accept" rule settings:

- Enter the name of the rule in **General**, for example, `ALLOW_PS-WLAN-1`.
- Remove all possible predefined action objects from the list and using **Actions > Add..** add an action object of type **ACCEPT**.
- In **Stations > Connection source**, enable the option **Connections from the following stations** and select **Add... > Add custom station**.
- In the Stations window that opens, select the option **All stations in local network** and for **Network name** select the name of your Public Spot IP network, e.g., `PS-WLAN-1`. **Close the dialog with OK**.
- In **Stations > Connection destination**, enable the option **Connections to the following stations** and after selection **Add...** choose **LOCALNET**.
- In **Services > Protocol/target services** enable the option **Following protocol/target services** and select **Add... > DNS**.
- End the filter rule dialog with a final click on **OK**.  
LANconfig then enters the allow rule into the rule table.

- "Reject" rule settings

- Enter the name of the rule in **General**, for example, `DENY_PS-WLAN-1`.
- Remove all possible predefined action objects from the list and using **Actions > Add..** add an action object of type **REJECT**.
- In **Stations > Connection source**, enable the option **Connections from the following stations** and select **Add... > Add custom station**.
- In the Stations window that opens, select the option **All stations in local network** and for **Network name** select the name of your Public Spot IP network, e.g., `PS-WLAN-1`. **Close the dialog with OK**.
- In **Stations > Connection destination**, enable the option **Connections to the following stations** and after selection **Add...** choose **LOCALNET**.
- End the filter rule dialog with a final click on **OK**.  
LANconfig then enters the rejection rule in the rule table.

#### 14. Store the configuration on your device.

That's it! You have completed configuration of your Public Spot module! Now, if you come within range of a Public Spot with a WLAN-capable device, the device can find the SSID that you set up as a public network and login to it.

### Setting default values for the Public Spot wizard

The following section describes how you define default values for the new-user wizard (**Create Public Spot account**).

1. Start LANconfig and open the configuration dialog for the device.
2. Change the view to **Public Spot > Wizard**.

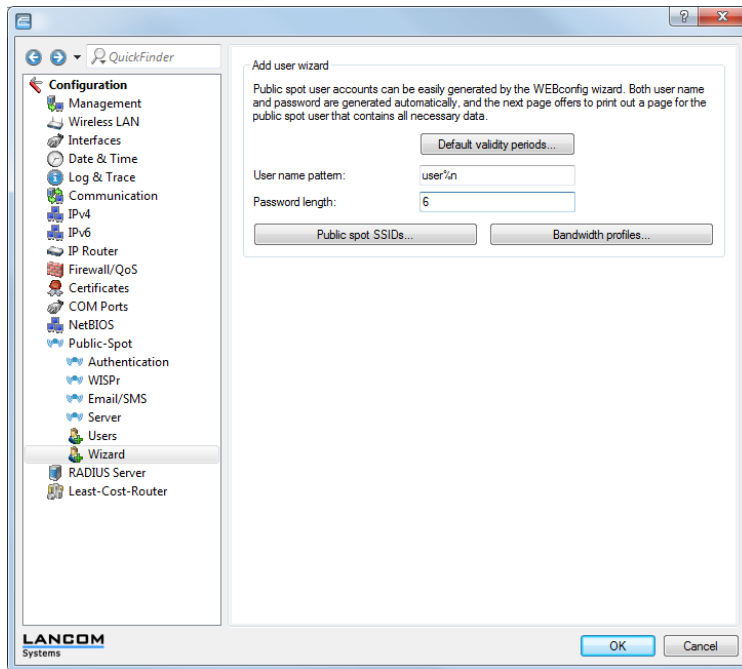

3. In **Default validity periods**, define which default validity periods for user accounts and vouchers are to be available by default.

The new-user wizard takes the shortest validity period as the default.

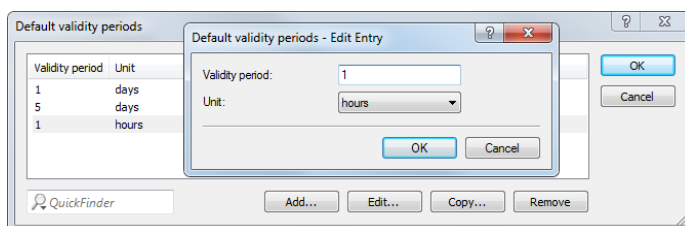

4. In **User name pattern** you indicate what pattern is used by the new user wizard to create usernames. You can enter up to 19 characters, whereby the wizard will automatically create a unique number for every user if you enter "%n". The default description `user%n` will be shown later on the voucher, for example, as `user12345`.
5. Using **Password length** you specify the length of the passwords that the new user wizard generates for Public Spot access. The default is 6 characters. If you would like to have longer passwords, keep in mind that guests can make mistakes when entering them, which can cause unnecessary problems and complaints.

- Public Spot via WLAN only: Using **Public Spot SSIDs** you specify the names of the Public Spot networks taken by default when you create new user accounts using the Create Public Spot account wizard.

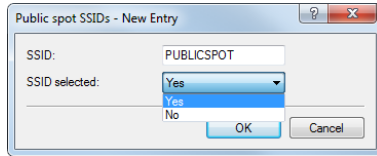

The Create Public Spot account wizard automatically marks the specified network names as **SSID selected** when creating a new Public Spot user. If you employ an access point, WLAN controller or WLAN router, for example, you can select several network names as default values in order to give users access to various different WLANs (e.g., for WLANs in the hotel lobby, the conference room, and floors where their rooms are located). When creating a new user and subsequently printing the voucher, these SSIDs are also printed out on the voucher.

Using the arrow buttons, you can change the display order of the SSIDs. In this way, SSIDs that are used most often can be kept at the top of the list.

### Setting up limited administrator rights for Public Spot managers

In order for employees to be able to manage a Public Spot on the device without further permissions, you can explicitly assign them the function rights to use the Public Spot wizard. This tutorial describes the steps to set up Public Spot function rights for employees without giving them additional administrator rights.

 You need to have the "Supervisor" permission to be able to assign Public Spot management to an employee.

- Start LANconfig.
- Open the configuration for the device for which you want to register a Public Spot administrator. The Public Spot option has to be enabled on this device.
- Change to the view **Management > Admin**, click in the section **Device configuration** on **Further administrators**, and then click on **Add**.

If you want to allow an existing user to perform Public Spot management, select the user's entry in the table and click on **Change**.

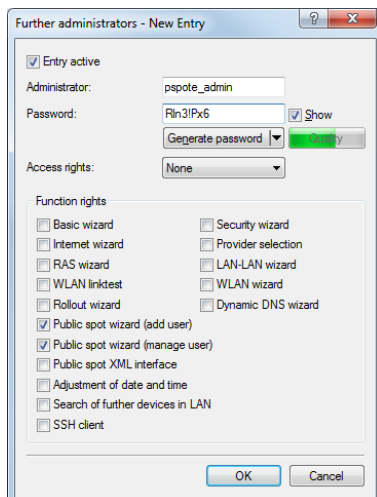

- You activate the profile by checking the **Entry enabled** box.
- Assign a descriptive name in the field **Administrator**.
- Enter a **password** and repeat it to be sure.
- Set the **Access rights** to **None**.  
When you modify an existing user, you should not modify existing function rights.

8. In the section **Function rights** enable the **Public Spot wizard (add user)**, and **Public Spot wizard (manage user)**.

When you modify an existing user, you should not modify existing function rights.

9. Save the new or modified profile by clicking on **OK**.

The Public Spot administrator is offered the Public-Spot wizards in the navigation when they log on using WEBconfig.

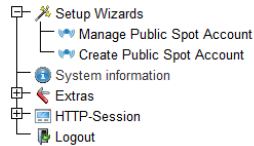

Using the user creation wizard **Create Public Spot account**, the administrator has the option of creating time-limited accounts for Public Spot users and print the corresponding login data on a voucher.

Using the user management wizard **Manage Public Spot account**, the administrator has the option of managing these users as well as the users that you created as the main administrator using the RADIUS user database. The administrator can extend or reduce the validity period of access, or completely delete a specific user account. In addition, the administrator can call up information about the user account using the wizard, such as the password in plain text, the authentication status, the IP address, the sent/received data volume or any restrictions that apply to the account.

 The function right **Public Spot XML interface** is not needed by a normal Public Spot admin. The right is only relevant if you use the [XML interface](#), and should not be combined with the function rights described above for security reasons.

## Setting up and managing Public Spot users for simple scenarios

You can set up and manage Public Spot users either manually or by using the setup wizard. Setting up and managing the configuration options manually offers you more extensive options and allows you, for example, to create self-defined users with an unlimited lifetime.

On the other hand, the setup wizard allows you to create generic Public Spot users with automatically generated login data with limited lifetimes. The respective setup wizard is only accessible using WEBconfig, which allows you to quickly create users without requiring administrator permissions for the entire device. The only requirement is an administrator with limited permissions.

You naturally also have the option to initially create generic users with the aid of the setup wizard and then manually adapt them to your needs (e.g., change the usernames).

### Setup and management using the Setup Wizard (WEBconfig)

The Setup Wizards provide you with an easy method of managing Public Spot users.

#### Adding Public Spot users with a single click and voucher printing

The following section describes the setup of a Public Spot user using WEBconfig and then printing a voucher. You can also prepare vouchers in advance.

 You need the permissions for the **Public Spot Wizard**, in order to create a new Public Spot user.

1. Log on to the WEBconfig home page as an Administrator.

2. Start the setup wizard by clicking on **Setup wizards > Create Public Spot account**

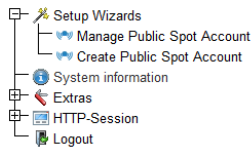

3. The new user wizard starts with an input screen. The fields have default values.

The wizard automatically creates a username and a password. In the subsequent printout dialog you can select the voucher printer and print-out the voucher.

4. If necessary, you can change the default values before you print it.

The following entries affect the appearance as well as the validity of the vouchers:

- **Starting time for account:** Sets the time when the voucher becomes valid. Possible values are:
  - `First login`: Access is valid as of the user's initial login
  - `Immediately`: Access is valid as of the creation of the user's account



To a supply of vouchers in advance, select `First login` as the validity of the vouchers. That way the vouchers will still be valid even after a longer period.

- **Validity period: Voucher expires after:** Enter the overall time period within which the voucher can remain valid.



If the access is to be valid immediately, it is not possible to enter a validity period.

- **Duration:** Set how long access is to be available after registration or the first login. The values listed here are managed in the **Default validity periods** table. The pre-defined values are:
  - `1 Hour (s)`
  - `1 Day (s)`
  - `5 Day (s)`
- **Max. concurrent logins:** Select the maximum number of concurrent devices that can have access to the user account for the corresponding user. The values listed here are managed in the **Max. concurrent logins table**. The pre-defined values are:
  - `Unlimited`

- Only 3 device(s)
- Only 10 device(s)
- **Multiple login:** Select this option in order to allow a user to login with several devices using the same login data. The number of devices that can be logged on simultaneously is specified using the drop-down list **Max-concurrent-logins**.
- **Bandwidth profile:** Select a bandwidth profile from the list in order to selectively restrict the amount of bandwidth available to the user (uplink and downlink). Create a bandwidth profile in the **Bandwidth profile** table.
- **SSID (network name):** Specify which wireless LAN network the access applies to. This SSIDs listed here are managed in the **SSID table**. By pressing the "Ctrl" button you have the option of selecting multiple entries. Default entries are already pre-selected.

---

! If you have not defined any entries in the table, the wizard conceals this option.

- **Number of vouchers:** Specify how many vouchers you want to create at a time. If you set the login time as the access start time, you can print-out a supply of vouchers in advance.
- **Time budget (minutes):** Specify the amount of time after which access to the Public Spot is closed.

---

! Depending on the chosen expiry method, access time is limited either to the time budget (incremental) or to the set voucher validity period (absolute).

- **Volume budget (MByte):** Specify the available data volume after which access is closed.
- **Comment (optional):** Enter a comment here. This comment can contain, for example, additional notes about the access duration or the telephone number of the receptionist in case of access problems.
- **Print comment on voucher:** Check this option if the comment is to appear on the voucher.
- **Print:** Check this option to print the vouchers as soon as they are registered.
- **User name case-sensitive:** Enable this option if Public Spot users have to pay attention to capitalization when entering their user name at login.

5. If you want to keep the default values or accept the new values without changing them, you click on **Save and print** at the end.

If the **Print** option is disabled, the wizard displays a summary of the new Public Spot users after they have been registered. You then have the opportunity to print the vouchers again.

### Wizard for Public Spot user management

The following section describes how to use WEBconfig to manage the registered Public Spot users.

---

! You need the **Public Spot wizard** permission, in order to manage a Public Spot account.

---

! Unsaved changes are lost once you finish this wizard.

1. Log on to the WEBconfig home page as an Administrator.
2. Start the setup wizard by clicking on **Setup-Wizards > Manage Public Spot accounts**

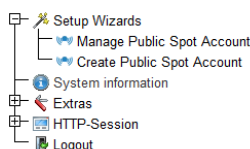

### 3. The Public Spot wizard starts with a list of registered Public Spot users.

Show 10 entries per page														Show/Hide Column	Save as CSV	
Page	User Name	Password	Comment	Expiry Type	Abs. Expiry	Rel. Expiry	Time Budget	Volume Budget	Case Sensitive	Tx Limit	Rx Limit	Online Time	Traffic (Rx/Tx Kbyte)	State	MAC Address	IP Address
<input type="checkbox"/>	user5498	7cjdj6	publicUser created by root on 23 05 2013 16:47:37 ()	Absolute and Relative	05/23/2014 16:07:37	0	0	0	No	0	0	0	0	Unauthenticated	00:00:00:00:00:00	0.0.0.0
<input type="checkbox"/>	user5573	4mbrdm	publicUser created by root on 24 05 2013 09:51:58 ()	Absolute and Relative	05/24/2014 09:51:58	0	0	0	No	0	0	0	0	Unauthenticated	00:00:00:00:00:00	0.0.0.0

Showing 1 to 2 of 2 entries

First page Previous page 1 Next page Last page

In the **Show... entries per page** drop-down list you set how many entries are displayed per page. The corresponding pages are accessed via the page navigation at the lower right:

- **First page:** Shows the page with the first entries.
- **Previous page:** Returns to the previous page.
- **Page numbers (1, 2, 3, ...):** Goes directly to the chosen page.
- **Next page:** Goes to the next page.
- **Last page:** Shows the page with the latest entries.

With **Search** you can filter the displayed entries. The filter immediately searches for entered strings.

You export highlighted entries with **Save as CSV**.

The column headers have the following meaning:

- **Page/All:** This column is used to select the user for the desired action (print, delete, save). To select all entries on the current page, select **Page**. To select all of the entries, select **All**.
- **Name:** Manually or automatically displays the username generated by the system.
- **Password:** Manually or automatically displays the password generated by the system.
- **Comment:** Includes the comment entered at registration (in brackets) and any changes to the user data (automatically documented by the system).
- **Expiry type:** Indicates whether the validity period of this user account is absolute (e.g. expires on a set date) or relative (expires after the time has elapsed since the first successful login).
- **Abs. expiry:** If "absolute" has been selected as the expiry type, the user account becomes invalid at the time defined in this field.
- **Rel. expiry:** If "relative" has been selected as the expiry type, the user account becomes invalid after this time period has expired since the user logged in for the first time.
- **Time budget:** Specifies the maximum access time for this user account. The user can use this duration of access time until a relative or absolute expiry time (if set) is reached.
- **Volume budget:** Specifies the maximum data volume for this user account. The user can use this data volume until a relative or absolute expiry time (if set) is reached.
- **Case sensitive:** Indicates whether the login page takes capitalization of the user name into account.
- **Tx-Limit:** If a bandwidth profile was entered for the user, this entry shows the maximum transmission bandwidth available to that user.
- **Rx-Limit:** If a bandwidth profile was entered for the user, this entry shows the maximum receiving bandwidth available to that user.
- **Traffic (Rx/Tx Kbyte):** Indicates the data volume in kilobytes that the user has received (Rx) or sent (Tx) so far.
- **State:** Shows the authentication status of the individual users. Possible values are:
  - **Unauthenticated:** The user is currently not logged on to the Public Spot.
  - **Authenticated:** The user is currently logged on to the Public Spot.
- **MAC-Address:** Indicates the physical address of the network adapter for the device with which the user is currently connected.
- **IP-Address:** This shows the IPv4 address that the system currently has allocated to the user.

The buttons at the bottom of the window have the following functions:



- **Print:** Print out the voucher for the selected user.
- **Delete:** Delete the selected user.
- **Save:** Save the changes.
- **Back to main page:** Return to the main page; all unsaved changes will be lost.

You can edit the following user information by changing the contents of the corresponding fields:

- **Expiry type**
  - **Abs. expiry**
  - **Case sensitive**
4. Select the account that you want to edit in the first column.
  5. Change the corresponding field values and click **Save** to apply the changes. Unsaved changes are lost once you finish this wizard.
  6. If you would like to delete a user, mark the corresponding entry in the first column and click **Delete**.

! The deletion takes place immediately without confirmation.

### Manual set up and management

The following configuration steps show you how to use LANconfig to manually setup a Public Spot user for simple scenarios. You create and manage Public Spot users using the **User database** of the device's internal RADIUS server under **RADIUS server > General**. Here you enter all of the users who should have access to the Public Spot – just as the setup wizard does as well.

! For user administration, the Public Spot module also has its own internal list (found under **Public Spot > Users > User list**). During technical development, this list was replaced as of LCOS 7.70 by the user administration via RADIUS. For compatibility reasons, the device still evaluates the internal user list of the Public Spot module if it is enabled. However, for a new installation you should no longer use this list, since it prevents you from using many features (setup and administration using the wizard, bandwidth restrictions, accounting via RADIUS, VLAN IDs for Public Spot users, etc.).

1. In **Name** you enter the usernames of future users or the **MAC addresses** of their end devices.

If you selected the authentication mode **Login with name and password**, enter the name of the username that the user employs to authenticate on the Public Spot. Entering a **password** is optional, however it is recommended for the authentication mode above.

- LANconfig: **RADIUS server > General > User database**

---

❗ If the authentication is performed using the MAC address (authentication modus **Authenticate with name, password and MAC address**), you define the MAC address using the field **Calling station** in the format `12:34:56:78:90:AB`.

2. Set the **Service-Type** to `Login`.
3. You remove all protocol restrictions by deselecting all check boxes.  
Two-phase authentication is not performed in a Public Spot scenario. This only makes sense for direct WLAN connections without Public Spot operations and the associated RADIUS users.

---

❗ If you do not completely remove the protocol restrictions, a user cannot log in using the login web page of your Public Spot!

4. Optional: On request, you can also, for example,
  - Enter a relative and/or absolute expiry date for the validity of the user account in the section **Validity/Expiry** (relative = validity in seconds after the first login);
  - Limit the uplink/downlink under **TX/RX bandwidth limit**;
  - Enable **Multiple login** and enter the **Max. concurrent logins** of end devices
5. Store the configuration on your device.

That's it! Your Public Spot users can now login with the credentials that you specified.

## 14.2.2 Security settings

The Public Spot has two additional safety mechanisms that effectively protect it against abuse.

### Traffic limit option

In order for clients to login to the Public Spot via a browser, it must be possible for unauthorized users to transfer data packets (e.g. for DNS requests) to the access point. By default, there is no limit on this data. The following risks are associated with this:

- **Unauthorized use of a Public Spot:** Certain tools enable a user to pack data into a DNS packet (i.e. to establish a DNS tunnel) and to work with the Public Spot without logging in.
- **Denial-of-Service:** The attacker could send large amounts of data to the device and thus try to block the device or Public Spot.
- **Brute force:** The attacker could repeatedly try to access the base station by guessing the login data until successfully breaking in.

The traffic limit option can effectively eliminate these risks.

You enable the traffic limit option by setting a value other than "0". This value determines the maximum data quantity in bytes that can be transmitted between the base station and an unauthorized terminal device.

- LANconfig: **Public Spot > Server > Allow access without authentication > Maximum data volume**

When a terminal device exceeds this traffic volume, the Public Spot locks this device and drops all data received from it without inspection. This lock expires only when the device entry disappears from the station table.

---

❗ For WLAN devices, this deletion can follow the general idle timeout, for example:

- WEBconfig: **LCOS menu tree > Setup > WLAN > Idle timeout**

Please keep in mind that if station monitoring is active, the lock may be removed earlier. If the mobile station cannot be reached for 60 seconds, the device removes its entry from the station table, and also the block.

---

❗ The idle timeout for the Public Spot module has the same purpose as the idle timeout for WLANs, but it applies only to connections via Public Spots. If the idle timeout is set and no further data packages are received from a user, the device automatically logs the device out at the end of the specified time period.

- LANconfig: **Public Spot > Server > Idle timeout**

On the one hand the optimal value for traffic limit depends on the data volume of the login page. On the other hand, this value has a significant effect on the potential number of failed login attempts per user. Generally, a traffic limit of 60,000 bytes provides effective protection for a Public Spot but allows a sufficient number of login attempts. You can adjust this value to your individual needs, if necessary. The default value of "0" bytes allows an unlimited volume of data.

! The traffic limit option only monitors the traffic before authentication. It does not take into account the traffic to and from a free Web server. This remains unlimited at all times.

## Restricting access to the configuration

Public Spot access to a Public Spot network's configuration (WEBconfig) should always be prohibited for security reasons. A special switch allows access via the Public Spot interface to be restricted to the Public Spot authentication pages only. All other configuration protocols are automatically blocked.

- LANconfig: **Public Spot > Server > WEBconfig access by Public Spot interfaces limited to authentication pages**

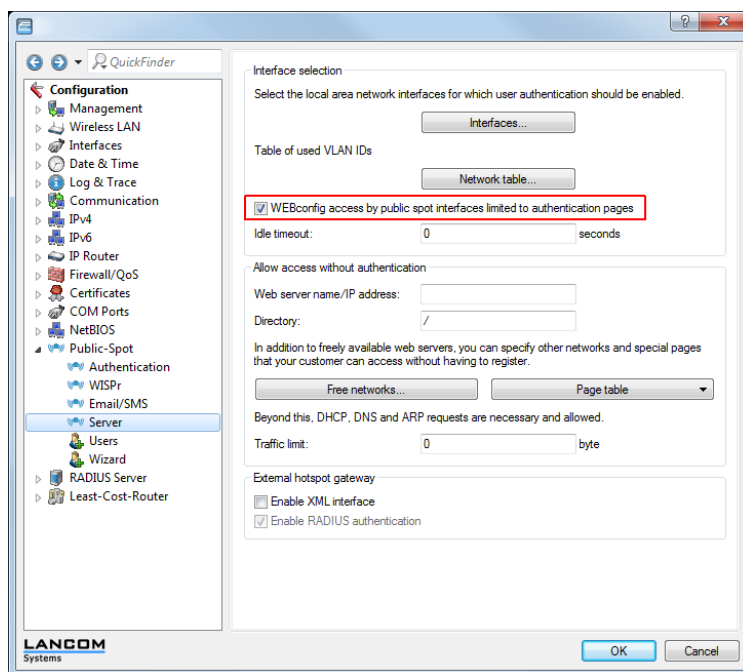

! Note that using permissions under **Management > Admin > Configurations access ways > Access rights** you cannot generally limit the access via HTTP(S) to the device.

## 14.2.3 Extended functions and settings

The Public Spot offers a wide range of extended functions, options and parameters, which can be used to adapt it to the specific requirements of the application at hand.

In the following sections you will find information about:

- Multiple logins
  - By default, the use of login data is restricted to login with one device. Find out how you increase this limit or completely remove this limit for a user account.
- Open access networks (no login)

Setup additional networks so that Public Spot users can also reach them without logging in to the Public Spot to provide the user with additional information (e.g., customer web sites inside the company, event calendars in a hotel).

- User administration using the Web API

Use URLs to create and administrate Public Spot users with file links or scripts.

- Individual bandwidth limitation

Individually set uplink and downlink restrictions for each Public Spot user.

- Automatic cleanup of user accounts and mobile stations

Use the device's own functions to automatically delete expired Public Spot user accounts and improperly logged off mobile stations (WLAN only) from the device's internal databases.

- WLAN handover of sessions between devices

Find out more about the roaming possibilities of mobile stations between access points, and what special configurations are necessary so that your users benefit from the seamless handover of WLAN sessions.

- Authentication via RADIUS

Find out how you can provide multiple RADIUS servers for authentication and accounting, and how you can chain them, in order to forward the user data to the appropriate backup system in case individual systems are unavailable.

- Accounting for Public Spot connections for commercial operation

Learn more about the accounting functions provided by the Public Spot for commercial operations. These billing functions can be roughly divided into two models:

- Retrospective payment for the resources actually used (credit accounting)
- Service use on a debit payment basis (PrePaid)

- Using multi-level certificates

Find out how to load certificate chains on your device.

- Individual assignment of VLAN IDs

Find out how to assign individual VLAN IDs to specific Public Spot users.

## Multiple logins

You have the ability to allow Public Spot users to simultaneously sign in using one user account for multiple devices. This can be necessary for a group of people (for example, a family) that has multiple devices, which they would like to use to simultaneously access the Internet.

### Setting default values

To use this feature, define the number of concurrent devices in the setup menu under **Public Spot module > Add user wizard > Max. concurrent logins table**. Enter the values here that you assigned in the second step with the **Add user wizard**. The value 0 stands for "unlimited".

### Enabling multiple logins in the new user wizard

When you invoke the Wizard **Create Public Spot account**, you will see the menu item **Max concurrent logins**. The values shown here correspond to the numbers that you previously entered in the table of the same name. The values are shown within the phrase "Only ... device(s)".

Select the maximum number of concurrent devices that can have access to the user account for the corresponding user. Please note that to enable the feature in the wizard, the option **Allow multiple logins** must also be enabled.

Starting time for account: first login

Validity period: voucher expires after: 365 days (max. 10 characters)

Duration: 1 Hour(s)

Max-Concurrent-Logins: Unlimited

Multiple-Login

Bandwidth profile: Visitor

SSID (Network Name): WLAN-Public  
WLAN-Private

Number of vouchers: 1 (possible values: 1 - 100) (required)

Time budget (minutes): 0 (possible values: 0 - 100000)

Volume budget (MByte): 0 (possible values: 0 - 4000)

Comment (optional): (max. 49 characters)

Print comment on voucher

Print

User name case-sensitive

## Open access networks (no login)

To provide users with access to important information without them having to login (e.g., important contact information) you can define any publicly available Web server.

- LANconfig: **Public Spot > Server > Web server name/IP Address**

If you do not want to completely release this service, you can optionally define an alternative path to the web server.

- LANconfig: **Public Spot > Server > Directory**

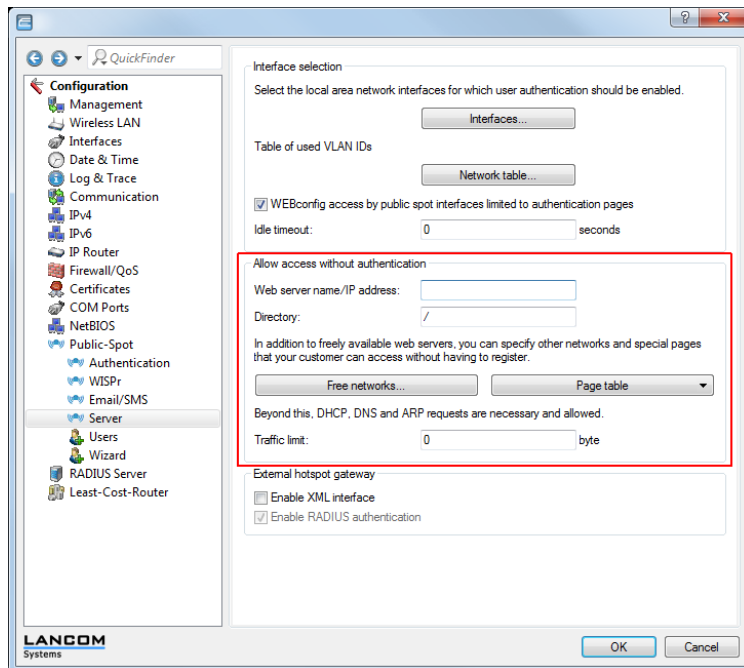

In addition to freely available web servers, you can define other networks and special sites which your customers can access without having to log on.

- LANconfig: **Public Spot > Server > Free networks or Page table**

### ■ Free networks

Enter the IP address of the server or of the network with its netmask, that your Public Spot users are to be given access to. Alternatively, you have the option of entering a domain name (with or without a wildcard "\*"). Wildcards can be used, for example, to allow free access to all of the subdomains of a particular domain. The entry \*.google.com allows the addresses mail.google.com, and maps.google.com, etc.

If you wish to authorize a domain or just a single workstation with the address named earlier, set 255.255.255.255 as the netmask here. If you wish to authorize a whole IP network, specify the corresponding netmask. If you do not set a netmask (value 0.0.0.0), the device ignores the table entry.

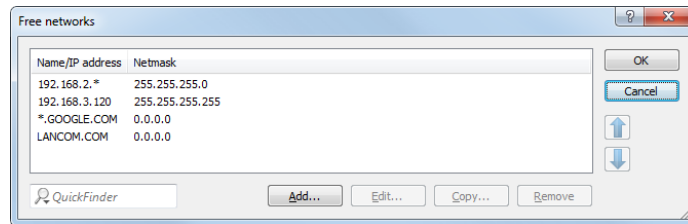

### ■ Page table

Enter the addresses (URLs) of the web pages to be displayed to users on the Public Spot in case of login, error, status display, etc. Read the chapter about [Default and customized authentication pages](#).

## DNS snooping

Web services with a high number of users distribute the requests for data to multiple servers for better utilization. This means that two DNS queries for the same hostname (e.g. "www.google.com") can lead to two different IP addresses. If a Public Spot receives more than one valid IP address for the specified host name from the DNS server, it chooses one of them and stores it for future requests by Public Spot users. If a different IP address for the same host name is allocated to the user by a different server for a subsequent request, the Public Spot blocks this connection because this IP address is not stored as the authenticated one.

In order for Public Spot users to be able to connect to the requested host despite changing IP addresses, the Public Spot analyzes the user's DNS queries and stores the returned IP address with the host name, the valid time to live (TTL), the age and the data source as a free destination address in the table **Status > Public Spot > Free-Hosts** for subsequent use.

The entries in this table will expire after the time period defined in the DNS response (TTL). When the limits are very low (e.g. 5 seconds), you can avoid locking out Public Spot users immediately after a request by setting a minimum validity under **Setup > Public Spot-Module > Free-Hosts-Minimum-TTL**.

## Managing Public Spot users via the web API

As an alternative to using the Setup Wizard, entering a special URL in the address bar gives you the option of displaying, creating or deleting Public-Spot users directly.

### URL structure

The URL is structured as follows:

`http://<Device-URL>/cm/pspotuser/...?action=actiontodo&parameter1=value1&parameter2=value2`

The following actions are available:

- **action=addpspotuser**: Creates one or more new Public Spot users and then prints out the required number of vouchers.
- **action=delpspotuser**: Deletes the Public Spot user with the specified user ID.
- **action=editpspotuser**: Displays the Public Spot user with the specified user ID. You can then print out the user's voucher again.

The required parameters and their values depend on the action specified.

- ⓘ The Wizard ignores incorrect parameter information and accepts only the correct parameters. If you omit a required parameter or specify it incorrectly, the wizard displays an input mask. Enter the correct parameter values here.

### Adding a Public Spot user

To register a new Public Spot user, simply enter the following URL:

```
http://<deviceURL>/cmdpbspotuser/
?action=addpbspotuser¶meter1=value1¶meter2=value2&...
```

The following parameters are available:

#### **comment**

Comment on the registered user

If it is possible to enter multiple comments for a Public Spot user, you can enter the comments and their corresponding comment-field names as follows:

```
&comment=<Content1>:<FieldName1>;<Content2>:<FieldName2>;...;<Content5>:<FieldName5>
```

If there is just one comment field per user, then the comment is entered as follows:

```
&comment=<Comment>
```

- ⓘ Special characters such as German umlauts are not supported.

- ⓘ The maximum number of characters for the comment parameter is 191 characters.

#### **print**

Automatic print-out of the voucher.

If this parameter is omitted, the wizard displays a button that you can use to print the voucher.

#### **printcomment**

Print the comment on the voucher.

If this parameter is omitted, no comment will appear on the voucher (default setting).

#### **nbGuests**

Number of Public Spot users to be created.

If this parameter is omitted, the wizard creates one user only (default setting).

#### **defaults**

Use default values

The wizard replaces missing or incorrect parameters with default values.

#### **expiretype**

Combined output of expiry type and validity period of the voucher.

Specify this parameter as follows:

```
&expiretype=<Value1>+validper=<Value2>
```

The parameter values have the following meaning:

- Value1: Expiry type (absolute, relative, absolute and relative, none)
- Value2: Voucher validity period

If these parameters are omitted or set with incorrect values the wizard will apply the default values.

**ssid**

Network name

If this parameter is omitted, the wizard uses the default network name (default setting).

**unit**

Access time

Specify this parameter as follows:

```
&unit=<Value1>+runtime=<Value2>
```

The parameter values have the following meaning:

- Value1: Lifetime units. Possible values are: Minute, hour, day
- Value2: Duration

**timebudget**

Time budget

If this parameter is omitted, the wizard uses the default value.

**volumebudget**

Volume budget

If this parameter is omitted, the wizard uses the default value.

**multilogin**

Multiple logins

If you specify this parameter, the user can login multiple times with his/her user account. If this parameter is missing, multiple logins are disabled by default.

**maxconclgin**

Maximum number of concurrent logins

With this parameter you specify with how many different end devices a user can login to a Public Spot. Valid entries are integers such as 0, 1, 2, . . . .

If this parameter is missing or if the parameter has the value 0, this means that the number of devices is unlimited.



This parameter requires that multiple logins be enabled. Setting this parameter in isolation has no other effects.

**casesensitive**

User name case-sensitive:

If you enter this parameter, the Public Spot user must pay attention to capitalization when entering the user name at login. Valid values are:

- 0: Case-sensitive username is disabled
- 1: Case-sensitive username is enabled

If this parameter is omitted, the wizard uses the default value.

**bandwidthprof**

Bandwidth profile



With this parameter you assign a pre-defined bandwidth profile to a Public Spot user. Enter the valid value for this parameter as the line number of an existing profile name under **Setup > Public Spot module > Add user wizard > Bandwidth profiles**, such as

```
&bandwidthprof=1
```

to index the first entry in the table.

If this parameter is missing or the line number is invalid (for example, the table is empty), the wizard does not limit the bandwidth.



If the Public Spot administration contains no default values to replace missing parameters, the wizard opens a dialog. Enter the missing values here.

### Modifying a Public Spot user

Modify one or more Public Spot users simply by entering the following URL:

```
http://<device-URL>/cmdpbspotuser/...?action=editpbspotuser¶meter1=value1¶meter2=value2&...
```

The following parameters are available:

#### **pbspotuser**

Name of the Public Spot user

Specify multiple users in the form `&pbspotuser=<User1>+<User2>+ . . .`

If the wizard cannot find the specified user, you have the option to search for a user.

After making your changes, accept these and print them out if necessary.

#### **expiretype**

Combined output of expiry type and validity period of the voucher.

Specify this parameter as follows:

```
&expiretype=<Value1>+validper=<Value2>
```

The parameter values have the following meaning:

- Value1: Expiry type (absolute, relative, absolute and relative, none)
- Value2: Voucher validity period

#### **unit**

Access time

Specify this parameter as follows:

```
&unit=<Value1>+runtime=<Value2>
```

The parameter values have the following meaning:

- Value1: Lifetime units. Possible values are
  - Minute
  - Hour
  - Day
- Value2: Duration

#### **timebudget**

Time budget

If this parameter is omitted, the wizard uses the default value.

**volumebudget**

Volume budget

If this parameter is omitted, the wizard uses the default value.

**print**

Automatic print-out of the voucher.

If this parameter is omitted, the wizard displays a button. Use this to print out the voucher.

**bandwidthprof**

Bandwidth profile

With this parameter you assign a pre-defined bandwidth profile to a Public Spot user. Enter the valid value for this parameter as the line number of an existing profile name under **Setup > Public Spot module > Add user wizard > Bandwidth profiles**, such as

```
&bandwidthprof=1
```

to index the first entry in the table.

If this parameter is missing or the line number is invalid (for example, the table is empty), the wizard does not limit the bandwidth.

 If the Public Spot administration contains no default values to replace missing parameters, the wizard opens a dialog. Enter the missing values here.

**Deleting a Public Spot user**

Delete one or more Public Spot users simply by entering the following URL:

```
http://<deviceURL>/cmdpbspotuser/...?action=delpbspotuser&pbSpotuser=<User1>+<User2>+...
```

If the wizard finds the specified user in the user list, the user is deleted and the wizard displays a confirming message.

If the wizard cannot find the specified user, it displays a table of registered Public Spot users. Mark the entries for deletion here.

**Bandwidth profile**

As of LCOS 8.82 you have the option of setting up bandwidth profiles for Public Spot users.

**Manage bandwidth profiles**

Using the window **Public-Spot > Wizard > Bandwidth profiles**, you have the ability to set up profiles that limit the available bandwidth (uplink and downlink) for Public Spot users. These profiles can be assigned to new users when access is created for the Public Spot by calling the Setup-Wizard **Create Public Spot account** in WEBconfig.

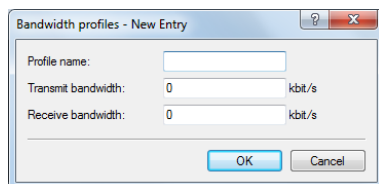

In order to edit the entries in the table **Bandwidth profiles**, click on the button **Add...** The entries in the edit window have the following meaning:

- **Profile name:** Enter the name for the bandwidth profile here.
- **TX bandwidth:** Enter the maximum uplink bandwidth (in kbps), which should be available to a Public Spot user. To limit the bandwidth, for example, to 1 Mbps, enter the value 1024.

- **RX bandwidth:** Enter the maximum downlink bandwidth (in kbps), which should be available to a Public Spot user. To limit the bandwidth, for example, to 1 Mbps, enter the value 1024.

### Assigning bandwidth profiles

The following steps describe how you assign the available bandwidth profiles to a Public Spot user.

1. Open WEBconfig.
2. Start the add user wizard under **Setup Wizards > Create Public Spot account**.
3. Assign the new user an appropriate profile from the selection list **Bandwidth profile**.

The screenshot shows a configuration form for creating a Public Spot account. The 'Bandwidth profile' field is highlighted with a red box, and its dropdown menu is open, showing four options: 'Visitor', 'Visitor', 'Standard', and 'Premium'. The 'Standard' option is currently selected.

When creating a new user, the RADIUS server automatically assigns the upper and lower boundaries of the bandwidth profile (not the bandwidth profile per se) to the associated account.

### Clear user list automatically

The device gives you the option to delete expired accounts for Public Spot users automatically.

Users of the Public Spot Wizard are generally administrators with restricted rights who are often unable to delete user table entries themselves. Because the user table has a limited number of entries, outdated entries could limit the capacity of the Public Spot. We strongly recommend that you activate this option.

If you use the internal RADIUS server for the administration of user accounts, enable automatic clean-up under **RADIUS server > General > Clear user lists automatically**

ⓘ These settings have no effect on the user table on an external RADIUS server.

The following list offers you a general overview of which capacity limits apply to specific models. If you cannot find your device, please check the exact details in the product description.

**Table 5: Size of the user table for specific LANCOM models**

LANCOM model	User table size
<ul style="list-style-type: none"> <li>■ access points</li> <li>■ Routers from the 178x series</li> </ul> with "Public Spot" option	64
<ul style="list-style-type: none"> <li>■ WLC-4006(+)</li> </ul>	256
<ul style="list-style-type: none"> <li>■ WLC-4025</li> <li>■ WLC-4025(+)</li> <li>■ WLC-4100</li> <li>■ 7100(+) VPN</li> <li>■ 9100(+) VPN</li> </ul> with "Public Spot XL" option	unlimited*

\*) No limitation on the table; however, an upper limit of max. 2,500 users is recommended

### Station monitoring

If station monitoring is activated, the Public Spot regularly checks to see if the associated end devices are still available. Lost end devices are automatically deleted from the local user table. If station monitoring is switched off, a user is not logged off until the validity period of the user's authentication expires.

 Station monitoring is extremely important for Public Spots operating commercially on a time basis. In installations of this type, users must be assured that they are only paying for the time actually spent using the Public Spot services.

### Configuration

Station monitoring for the Public Spot Module is disabled by default. You activate it by entering a value greater than 0 – this value disables the function – under **Public Spot > Server > Interface selection > Idle timeout**. From this point on, all end devices are automatically disconnected from the Public Spot after a specific time.

 If your device has WLAN, you also have the option of enabling station monitoring globally for all WLAN interfaces. You can find the corresponding settings under **Wireless LAN > Security > Monitor stations to detect inactive ones**. To do this, the device disconnects mobile stations after 60 seconds (default value). If WLAN station monitoring is disabled, this may take up to an hour.

If you offer Public Spot via WLAN, please note that the station monitoring of the WLAN takes priority over that for the Public Spot, and a disconnection can occur earlier if the idle timeout for WLAN (configurable in the Setup menu under **WLAN > Idle timeout**) is less than that for the Public Spot.

### Surveillance

You can monitor the Public Spot during operation using WEBconfig. The station table in the user authentication menu provides an overview of:

- Users currently logged in to the Public Spot and
- End devices in the WLAN which are not logged in.

You can navigate to the Station table in the Status menu under **Public Spot > Station Table**. Using the button **Monitor this table** you automatically refresh the table display at regular intervals.

### WLAN handover of sessions between devices

Whenever a site equipped with WLAN hotspots expands, it may be necessary to deploy more than one access point to cover the whole area. One option would be to use a central device as an authentication gateway, enable the Public Spot option on this device only, and require all other access points to redirect requests to the central device. In this way, all other access points act as simple, transparent bridges, which connect to the central gateway using the Ethernet backbone. This allows clients to freely roam among the access points since all session information is kept in the central gateway.

This variant has two drawbacks, however:

- The central gateway is a single point of failure, and is not scalable. You can reduce the risk of failures by using VRRP to create a redundancy solution.

 This solution requires an external RADIUS server, since VRRP cannot synchronize configurations, e.g. the user database. However, this means that certain functions (such as the Public Spot wizards in WEBconfig) are no longer available.

- Roaming is only necessary when the Public Spot module is installed on the access points themselves. Using a WLC, the authentication can be forwarded to the central gateway. In this case, the roaming between access points is transparent to the WLAN controller.

An alternative to this type of centralized setup is to enable the Public Spot module in all of the access points. Authentication and page processing handling is thereby distributed over all devices, and a single point of failure is eliminated.

### IAPP (inter access point protocol)

Since the Public Spot module is implemented as a "switchable" transparent bridge, there is no need for clients to acquire a new IP address after they roamed to another access point, so there is no need to terminate open connections. This results in the requirement that an already authenticated client does not have to re-authenticate after roaming to a new access point. Thus the authentication information should be carried over from the old to the new access point.

Access points use the IAPP (inter access point protocol) to share information about roaming clients: Whenever a wireless client decides to change to another access point, it has the option of informing the new AP about which AP it was previously connected to. This information, combined with regular Hello packets on the Ethernet backbone, enable the new access point to inform the old access point. The old access point can then remove the client from its station table and acknowledge the handover.

If a client does not use the corresponding Reassociate packet for connecting to the new access point, the new access point sends a handover request as a multicast on the backbone, instead of a directed packet to the old access point. This means that this handover also works for clients that do not support IAPP.

The main task of the IAPP in a WLAN is to tell the old access point not to send any more packets to the corresponding client in its wireless area, since it will no longer receive them. This type of behavior (based on the definition of the 802.11 frame exchange protocol) could otherwise cause problems with other clients that are connected with it.

In case of an enabled Public Spot module, the communication channel provided by IAPP is used to transport the session information of wireless clients. Whenever an access point receives a handover request for one of its wireless clients, and if a session record for this client is available in its station table, it will append state information about this client to the requesting access point. This information includes:

- The client's current state (authenticated or not authenticated)

In case the client is authenticated, it also includes:

- The username used to authenticate
  - The amount of data traffic generated by the client so far
  - The session duration so far
  - The IP address of the client
  - Possible limits on the session duration and data volumes
  - Possible information about idle timeouts
- If RADIUS accounting was used for the session:
    - The entry used for RADIUS accounting in the authentication server list, referenced by name
    - The accounting cycle used for interim updates

After a successful transfer, the old access point terminates the session, which, in the case of RADIUS accounting, means that it sends an accounting stop request to the RADIUS accounting server. This is necessary since a RADIUS server can use the NAS identification to associate requests with specific sessions, and these requests can no longer be associated with the correct sessions once the data packets for a session come from more than one device. If an access point receives this information in a handover reply, it immediately marks the client as authenticated and starts a new RADIUS accounting session, if possible.

---

 Note that the new access point requires a corresponding entry in its **Authentication server** list in order to receive the necessary information. The specific part of the handover reply for the Public Spot module is protected by a shared secret, which is set in the setup menu under **Public-Spot-Module > Roaming-Secret**. These security measures should prevent falsification of handover replies. Without a password configured, the access point does not append the information above on a handover reply, which forces the client to authenticate again.

## Authentication via RADIUS

RADIUS is an extensively accepted protocol for providing large groups of users access to a server. Although it was originally developed for dial-in server access over telephone lines, the concept is also useful for the hotspot authentication process. For that reason, it can be used in a more complex provider network, for example, to provide access for the same users via dial-in and hotspots. You configure RADIUS servers and their access parameters in the dialog **Public Spot > Server** under **Authentication servers**.

In certain scenarios, it can be feasible to use more than one RADIUS server. In general, a RADIUS server is specified by its IP address, the UDP port the RADIUS service is bound to (typical ports are 1645 or 1812), and a so-called "shared secret". This is a random character string which acts as a password for access to the server. Only clients which know the shared secret can interact with the RADIUS server, since the password for the user account is hashed instead of being sent in plain text.

In theory, the simplest possible RADIUS transaction consists of the device sending the entered account data (user name + password) to the RADIUS server and the RADIUS server responding with either "yes" or "no". However, the RADIUS protocol also allows more complex responses and requests where the communication partners use a list of variables – so-called "attributes" – for requests and responses. In the [Appendix](#) there is a list of which attributes a device can send to a RADIUS server and which attributes from a RADIUS response are understood by the device.

### Multiple authentication servers

As mentioned previously, the list of authentication servers can contain more than one entry. There may be situations where the hotspot provides access to the Internet for customers from different service providers. These providers may have separate user databases and their own RADIUS servers. The device must select which provider corresponds to the user based on the username.

Whenever the device does not find an entry for an authenticated user in its local table, it will first search through the authentication server list to find the provider that corresponds to the user. For example, user account names like `JohnDoe@lancom.de` contains the authentication server entry named `LANCOM`. If the first allocation does not work, the device attempts to allocate the entry `DEFAULT` to the user. If this entry also does not exist, the device selects the authentication server that is first in the list. If the device does not find an entry (i.e., the list is empty), the user authentication fails.

Depending on the allocation of a user to a authentication server, your device always transmits the complete username to the selected RADIUS server. The selected RADIUS server is stored as the provider for the subsequent session and used for optional RADIUS accounting.

### Chaining of backup servers

Internet access providers wish to provide a very high level of availability, and a common method to achieve this relies on redundancy. This redundancy is achieved using the backup servers which are needed when a request times out on the primary server, for example, because the server or another network component along the way was unavailable.

The requirements for backup servers varies widely among the different providers, which is why the list of authentication servers does not have a specific number of input fields. Instead, the device offers you a series of backup servers (backup chaining). Here, two or more entries in the authentication server table may be chained together to form a list of RADIUS servers. The device looks through the list of RADIUS servers one by one until the end of the list is reached (authentication failure due to server unavailability) or a response from a server (either positive or negative) is obtained.

You chain backup servers using the input field **Backup name** in the add/edit dialog under **Public Spot > Server > Authentication server**. Whenever a RADIUS request fails (i.e. times out), the device checks the backup field, and continues to try the RADIUS server specified in the entry that is referenced by the backup name. In general, an unlimited number of servers can be connected this way, which makes it possible for several providers to assign the same fallback server. The chain of backup servers is considered to be terminated if one of the following conditions occurs:

- Querying a RADIUS server failed and the corresponding authentication server table entry has an empty backup field.
- Querying a RADIUS server failed and the corresponding provider table entry has an invalid backup field, i.e. the entry referenced is not present in the authentication server list.

- Querying a RADIUS server failed and the corresponding authentication server list entry refers to an entry that has already been used in the query process. This avoids endless RADIUS requests due to circular references. It is possible to specify two RADIUS servers that reference each other as backups, with the primary server being selected by the user account name.

ⓘ While the device is sending a RADIUS request, the TCP/HTTP connection to the client still exists. If the runtime of the chaining exceeds the lifetime of the TCP/HTTP connection, the client interrupts the login attempt. Therefore, it may be recommended to reduce the number of request retries to the individual backup servers as well as the time intervals between requests. These settings can be made in **RADIUS server > Options**.

### Billing without a RADIUS accounting server

If user administration is performed using the internal user list of the Public Spot module, and you do not want to use a RADIUS accounting server, your only option is to use the expiry date of the user account for accounting purposes.

The use of the internal user list is no longer recommended. Instead, in order to take advantage of all of the options the Public Spot offers, you should use the internal RADIUS server for new installations.

ⓘ For the purposes of billing by credit payment, the Public Spot can use SYSLOG to output detailed connection information to any computer in the network. Using the appropriate software on the destination computer allows you to precisely bill the resources that were actually used (such as connection times or transfer volumes).

### Billing via RADIUS accounting server

For the purposes of billing via a RADIUS server, you can set up the Public Spot so that it regularly supplies the current connection information for every active user to the specified accounting server. Accounting is started when a client is authenticated using RADIUS and a valid **Accounting server** is configured for the relevant **Authentication server** in the list of **Authentication servers**. It is possible to use different RADIUS servers for authentication and accounting.

Each of the regular message packets to the accounting server contains information about the resources (time, transferred data volumes, etc.) consumed by the user since the last message. This means that, even in the worst case of a Public Spot failure (e.g., due to a power outage or similar), only a small amount of accounting information will be lost.

Periodic messaging of accounting information to the accounting server (interim updates) is deactivated by default. It is activated by setting a value for the accounting cycle which is greater than 0.

- LANconfig: **Public Spot > Users > Update cycle**

ⓘ This cycle is defined in seconds. This sets the time interval of when your device regularly sends connection information to the accounting server. Setting the cycle to 0 deactivates this function. If this is the case, your device only sends accounting information at the beginning and end of the session.

When accounting on a prepaid basis, the RADIUS server monitors the restrictions on the users (limits on connection times or transfer volumes, expiry date). As soon as a user has used up the prepaid amount, the RADIUS server locks the user account. Your device rejects future login attempts for the user.

ⓘ Time limits for prepaid models can be monitored by the Public Spot during active sessions. If a time limit is exceeded, the Public Spot automatically terminates the corresponding session. The monitoring of prepaid amounts is possible if the RADIUS server transmits the user's time credit to the Public Spot as the "Session timeout" attribute at the start of the session.

### Request types

Your device is able to send different types of RADIUS requests to an accounting server. These requests differ according to a user's session state:

- An accounting start request is sent after a successful authentication.
- An accounting stop request is sent after a Public Spot session is terminated.
- Optional: Interim updates are sent throughout the session.

There are two types of interim updates: An initial update is sent immediately after the start request since some RADIUS servers need this in order to create a session in the accounting database. All further updates depend on whether an accounting cycle was created for the respective session (see **Public Spot > Users > Accounting update cycle**).

Alternatively, this value may be included in a RADIUS authentication response: The RADIUS server offers the RADIUS client (for example, your Public Spot) an interim accounting interval, which the client will use if it has the appropriate support for this and as long as no interval was set locally on the device itself.

**!** If a local value was set, it will always be given a higher priority than the one received from a RADIUS server, which the RADIUS RFCs require by default!

In the [Appendix](#) there is a list of which attributes a device can send to a RADIUS server and which attributes from a RADIUS response are understood by the device.

### Accounting backup

The backup solution for RADIUS accounting is the same as the one for RADIUS authentication, in that your device goes through the entries in the authentication server list one by one (see chapter [Chaining of backup servers](#)). The backup entries for the accounting server should be chosen with the same care as for the authentication server: If you are using multiple backups, you will probably have to reduce the timeout/try values for the requests in order to achieve reasonable response times for the entire system.

**!** User sessions are not paused while the device sends accounting requests, which consumes additional resources in the device—in contrast to authentication. Please ensure that the time required for the selection of an accounting server\* should be less than the length of an accounting cycle for interim update requests. This stops the requests from queuing up, which would result in a stack overflow.

\* *Number of backups x (idle timeout + number of retries)*

### Multi-level certificates for PublicSpots

SSL certificate chains can be loaded into the device as a PKCS#12 container. These certificate chains can be used for Public Spot authentication pages by using the HTTPS server implemented in the device. Certificates from recognized trust centers are normally multi-level. Officially signed certificates in the Public Spot are necessary to avoid certificate-related error messages from the browser when authenticating at a Public Spot.

The certificate is loaded into the device for example by using WEBconfig in File Management to upload the individual files of the root CA certificate or a PKCS#12 container:

The screenshot displays the LANCOM Systems WEBconfig interface. On the left is a navigation tree with 'File management' expanded. The main window shows the 'Upload Certificate or File' dialog. The dialog includes a 'File Type' dropdown menu, a 'File Name/Location' text field, and a 'Passphrase (if required):' text field. Below these fields is a list of file types and their corresponding file names/locations. The selected file type is 'SSL - Container as PKCS#12-File (\*.pfx, \*.p12)'. A note at the bottom of the dialog states: 'Caution: Files are not being checked by the individual modules until the VPN status trace immediately after the upload.' A checkbox for 'Replace existing CA certificate' is also present.



Certificates are normally issued for DNS names, so the Public Spot must specify the certificate's DNS name as the destination and not an internal IP address (enter in **Setup > Public Spot Module > Device Host Name**). This name has to be resolved by the DNS server to provide the corresponding IP address of the Public Spot.

LCOS Menu Tree  
 Setup  
 Public-Spot-Module  
**Device-Hostname**  
 Device-Hostname: mypublicspotexample.com (max. 31 characters)

## Assigning users to individual VLANs

Regardless of the assignment of a VLAN ID for the entire Public Spot module, the device offers you the option of separately assigning individual VLAN IDs for individual Public Spot users. This ID is automatically assigned by the RADIUS server to your users after successful authentication. In this way it is possible, for example, to classify different Public Spot users in separate networks with different access rights and access options without having them login to separate SSIDs or requiring you to publicize the availability of various networks (e.g., networks for different customer types). The relevant rules can be realized via the firewall by specifying the VLAN ID of the respective user/the relevant user groups as the source tag.

 An enabled VLAN module is a prerequisite for the functions described above.

User table - New Entry

Name / MAC address:

Case sensitive username check

Password:

**VLAN ID: 0**

Comment:

Service type:

Protocol restriction for authentication  
 PAP  CHAP  
 MSCHAP  MSCHAPv2  
 EAP

If here are made no restrictions, all authentication protocols will be allowed automatically!

Passphrase (optional):

TX bandwidth limit:  kbit/s  
 RX bandwidth limit:  kbit/s

Station mask:  
 Calling station:   
 Called station:

Validity/Expiry  
 Expiry type:   
 Relative expiry:   
 Absolute expiry:  :  :  :  :

Multiple login

Max. concurrent logins:

Time budget:  seconds  
 Volume budget:  byte

- Open the **User table** in the dialog **RADIUS server General** and click **Add...** to create a new user.
- Assign an individual VLAN ID to the new user with the input field **VLAN-ID**. After authentication by the RADIUS server, the individual VLAN ID overwrites a global VLAN ID that a user would otherwise obtain from the interface. The value 0 disables the assignment of an individual VLAN ID.

 For technical reasons, the assignment of a VLAN ID requires a new address assignment by the DHCP server. As long as a client is not yet assigned a new address after successful authentication, the client is still in the previous (e.g., untagged) network. In order for the clients to be transferred to the new network as quickly as possible, it is necessary to set the lease time of the DHCP server as low as possible under **IPv4 > DHCPv4**. Possible values (in minutes) include, for example:

- **Maximum lease time:** 2
- **Default lease time:** 1

Take into account that a strong reduction in global lease time can flood your network with DHCP messages, and when there is a larger number of users, it leads to an increased network load! Alternatively, you have the option of using an external DHCP server or allowing your users to manually request a new address by using their client.

In the Windows command line this is done, for example, using the commands `ipconfig /release` and `ipconfig /renew`.

- ! By assigning a VLAN-ID, the user loses his connection after the initial DHCP lease expires. The connection only remains stable as of the second lease, i.e. after successfully assigning the VLAN-ID.

### 14.2.4 Alternative login methods

In addition to the login using the login data that was sent previously, your users can also request login data themselves via e-mail or text message (SMS), or by accepting the terms and conditions for the Public Spot (one-click login). Alternatively, in order to implement more complex or multi-level login scenarios, you can link your Public Spot to other software systems using the XML or PMS interface (module optionally available).

You can also offer your users additional convenience by allowing, for example, automatic login processes (automatic login as well as re-login using a MAC address, login using WISPr, Hotspot 2.0), and also the related roaming services.

- ! Hotspot 2.0 and roaming features are only available in conjunction with WLAN.

### Overview of authentication modes

In this window, specify the settings for authentication to the network.

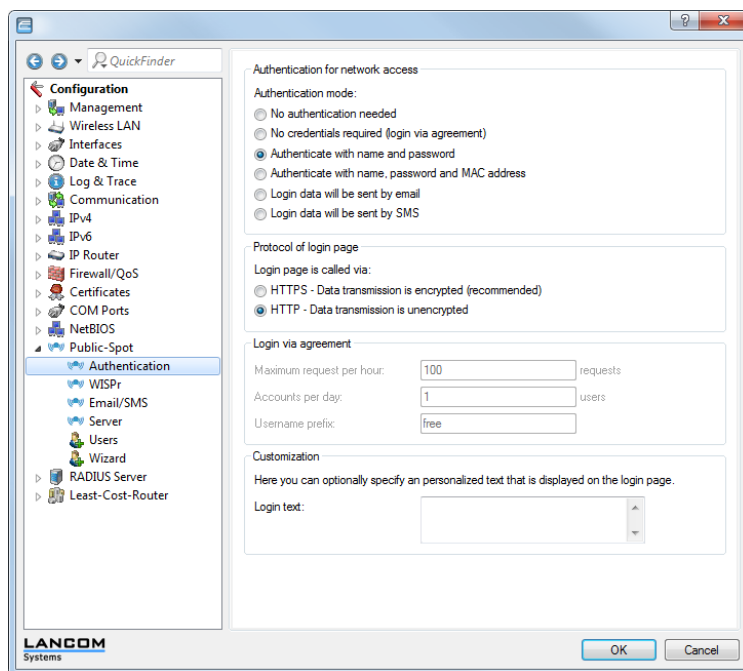

The following authentication modes are available:

- **No authentication required**

Users get free access to the Public Spot, authentication is not required.

- ! Do not use this setting if your device has unlimited access to the Internet.

- **No credentials required (login after agreement)**

Users get free access to the Public Spot after they accept the operator's terms of use (one-click login). With a RADIUS server, login is completely transparent for the user. The prerequisite is that you have set up an individual welcome page with its own terms of use: In this case, the Public Spot initially forwards a user to the welcome page, where he

must agree to the terms of use. After confirmation, the device automatically creates a user account according to the default values in the **Add user wizard** (under **Public-Spot > Wizard**) and provides access to the connected network.

Under **Login after agreement** you specify the framework conditions for the creation of free user accounts by the RADIUS server:

- **Maximum requests per hour:** Specify how many users per hour can automatically create an account on the device. Decrease this value to reduce performance degradation caused by an excessive number of users.
- **Accounts per day:** Specify how many accounts a user may create per day. If this value is reached and the user session has expired, a user can not automatically register and get authenticated on the Public Spot for the rest of the day.
- **Username prefix:** Enter a prefix which can be used to identify the user in the RADIUS user table that the device created automatically after confirmation of the terms of use.

---

! To load a custom welcome page (htm, html) on the device, use the upload function under **Device > Configuration management > Upload certificate or file** and reference this file under **Public-Spot > Server > Page-Table > Welcome** in the field **Page address (URL)** with `file:///pbspot_template_welcome`. Templates for a welcome page and detailed information for uploading your own templates is available on the Internet in the LANCOM Support Knowledge Base under [Implementing your own websites](#).

---

! The terms featured on the Welcome screen are not to be confused with the terms-of-use page itself. The **Terms of use page** is a special page that is displayed only after a separate activation in connection with notification by e-mail/SMS.

---

! If no welcome page is set up, the device displays an error message when accessing the Public Spot.

#### ■ **Authenticate with name and password**

Users log on to the Public Spot with their name and their password. Users get their login data from a network administrator as a voucher.

#### ■ **Authenticate with name, password and MAC address**

Users log on to the Public Spot with their name and their password. Users get their login data from a network administrator as a voucher. For this login mode, the MAC address of the client must also match the one stored in the user list by the administrator.

#### ■ **Login data will be sent by e-mail**

Users log on to the Public Spot with their name and their password. Users generate the credentials themselves, and the data is sent via e-mail. No action by an administrator is necessary.

#### ■ **Login data will be sent by SMS (text message)**

Users log on to the Public Spot with their name and their password. Users generate the credentials themselves, and the data is sent by SMS (text message). No action by an administrator is necessary.

### **Independent user authentication (Smart Ticket)**

Devices operating a Public Spot provide users with time-limited access to wireless networks. Until now an administrator account was necessary to create a login on a device with the Public Spot. For employees at a hotel reception desk, for example, you can set up an administrator account that only has the function rights to create Public Spot users. With a few mouse clicks the employee can print a voucher for the hotel guests for access to the wireless network.

However, the easy voucher solution still requires action from an administrator. Alternatively, you can give the users the option to generate their own login data for the wireless network from the homepage of the Public Spot, and send it to themselves by e-mail or SMS (text message). In order to send e-mail, an SMTP account must be fully set up in the device settings. To send SMS/text messages the device uses an external SMS provider, which can charge fees to the Public-Spot operator or user, if desired.

Alternatively, the device gives you the ability to handle the login for Public Spot users transparently using a RADIUS server. In this case, the user login is preceded by checking the terms of use, whereby the user must first consent to the terms of use stored on the device before automatically receiving access to the Public Spot (one-click login). The creation of credentials by the user via e-mail or SMS does not apply for this authentication method.

### Configuring e-mail/SMS authentication

You define the settings for sending the login credentials via e-mail or SMS in the dialog **Public Spot > E-mail/SMS**.

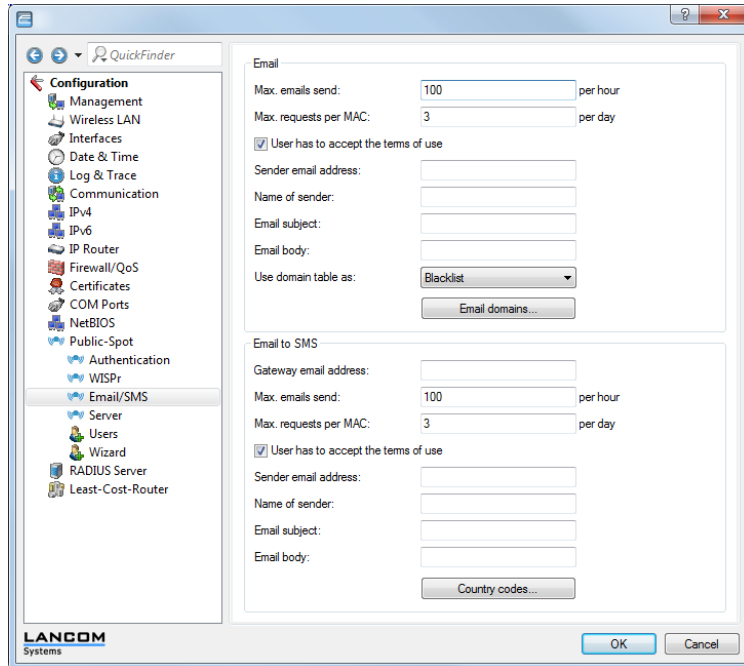

You have following configuration options:

- **Max. e-mails send:** Here, enter the maximum number of e-mails that the Public Spot module may send per hour to users authenticating via e-mail. Lower the value to reduce the number of new users per hour.
- **Max. requests per MAC:** Specify how many different sets of credentials the device can provide to a MAC address within one day.
- **User has to accept the terms of use:** If you select this option, the Public Spot login page displays an additional option, which prompts the user to accept the terms of use before registering via e-mail/SMS.



Remember to upload a page with terms and conditions onto the device before you enable this option. Otherwise, the device will only show the user a placeholder instead of the terms and conditions.

- **Sender e-mail address:** Enter the e-mail address that your e-mail contains as the return address, e.g. support@providerX.org.
- **Name of sender:** Specify the name shown to your users as the sender of the e-mail, e.g. Provider X. If you leave this field blank, the device automatically enters the default text as described in the following section.
- **E-mail subject:** Type the subject line for the e-mail. If you leave this field blank, the device automatically enters the default text as described in the following section.
- **E-mail body:** Type the message text for the e-mail. You can use the following variables:

#### **\$PSpotPasswd**

Placeholder for user-specific password for the Public Spot access.

#### **\$PSpotLogoutLink**

Placeholder for the logout URL of the Public Spot in the form `http://<IP address of the Public Spot>/authen/logout`. This URL enables Public Spot users to log off from the Public

Spot. This may be useful if the session window (which also contains this link) that is normally displayed after a successful login is blocked by the browser or closed by the user.

If you leave this field blank, the device automatically enters the default text as described in the following section.

- **Use domain table as:** Specify whether the device uses the table **E-mail domains** as a blacklist or whitelist. This definition sets which e-mail addresses or domains may be entered by your Public Spot users in order to register.
  - **Blacklist:** Registration is permitted on all e-mail domains except those in this table.
  - **Whitelist:** Registration is possible only via the e-mail domains that are present in this table.
- **Gateway e-mail address:** Here you enter the IP address or the hostname of the gateway server, which converts the e-mail into SMS. If the provider expects to find the mobile phone number in the local part of the e-mail, you can use the variable `$PSpotUserMobileNo`.
- **Country codes:** In this table, enter the country codes accepted by the device. Country codes can be entered directly or with a prefixed double-zero, for example for Germany 49 or 0049.



This table acts as a whitelist. You **must** define country codes in order for the login data to be delivered.

### Standard texts for sender, subject and body

If you leave the following input fields in the dialog **Public Spot > E-mail/SMS** blank, the device automatically reverts to the standard texts stored in LCOS when generating the e-mail. The language used depends on the language setting of the browser used by the user for registration.

**Table 6: Overview of the internal standard texts for authentication via e-mail/SMS**

	German	English
<b>Name of sender</b>	Public Spot	Public Spot
<b>E-mail subject</b>	Ihre Anmelde Daten für den Public Spot	Your Public Spot account
<b>E-mail body</b>	Ihr Passwort für den LANCOM Public Spot: \$PSpotPasswd \$PSpotLogoutLink	Your password for the LANCOM Public Spot: \$PSpotPasswd \$PSpotLogoutLink

### Automatic re-login

Mobile WLAN clients (e.g., smart phones and tablet PCs) automatically log in to known WLAN networks (SSID) when they reenter the cell. In this case, many apps automatically and directly access web content using the web browser in order to request current data (such as e-mails, social networks, weather reports, etc.) It is similar for mobile LAN clients (e.g., notebooks) which have to be disconnected from the network for a short time for a change of location (e.g., for changes from a lecture hall to a library in a college). In all of these cases, it is impractical to make the user manually log in to the Public Spot again in the browser.

With automatic re-login, the user only has to be identified on the Public Spot once. After a temporary absence, the user can seamlessly use the Public Spot again.

The Public Spot records the manual login and logout as well as a re-login in the SYSLOG. It stores the same login data for a re-login that a user had employed for initial authentication.



The authentication is only performed on the MAC address of the client when re-login is enabled. Since it can lead to security problems, re-login is disabled by default.

The settings for automatic re-login can be found in LANconfig in the device configuration under **Public Spot > Users** in the section **Users and authentication servers**.

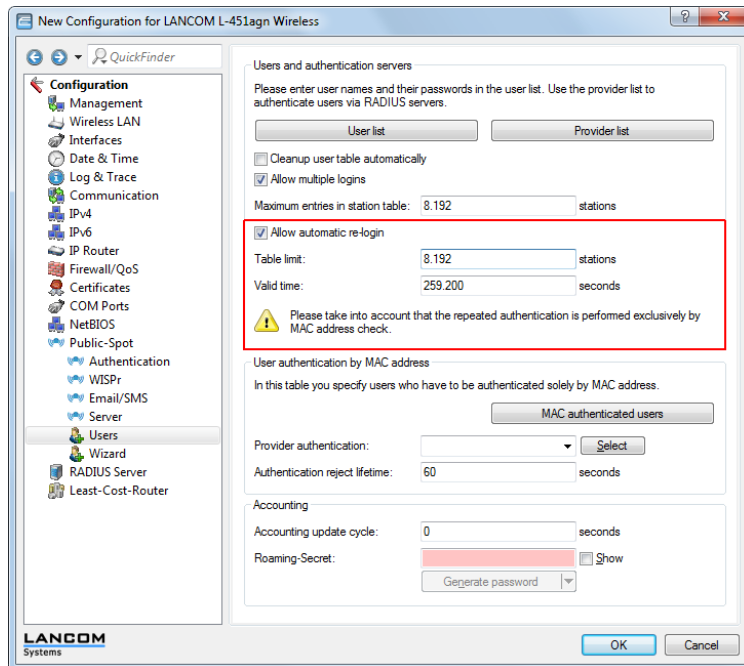

The selection box **Allow automatic re-login** enables this function.

You specify the number of clients (maximum 65536) in the field **Automatic re-login table limit** that the re-login function may use.

In the field **Automatic re-login valid time** you specify how long the Public Spot stores the credentials of a client in the table for a re-login. After this period expires, the Public Spot user must log in again using the login page of the Public Spot in the browser.

### Automatic authentication with the MAC address

After successful authentication, a Public Spot gives the user access to certain services. The Public Spot usually displays a login website to allow users to authenticate themselves. The user enters the authorization credentials into the login page and the Public Spot then redirects the user to the allowed sites.

In some applications, authentication via web site may not be desired or not possible, as the following examples illustrate:

- The end device does not have a browser and therefore cannot open the login page.
- Manually accessing the login page may be undesirable, such as when carrying out a performance test.

Automatic authentication on the Public Spot with a MAC address makes it possible to use the Public Spot without first opening the login page. The administrator enters the MAC addresses of the corresponding end device into the table of permissible MAC addresses under **Public Spot > Users > MAC authenticated users**.

### The MAC-address check procedure

When the device receives a request from a client, the Public Spot executes the following steps for the automatic authentication by MAC address:

- If the Public Spot has already authenticated the MAC address of the received data packets, the device forwards the data packets without further delay.
- If the MAC address is in the list of allowed clients, the Public Spot starts a new session for the user and forwards the corresponding data packets.

- If a provider has been defined for verification of the MAC addresses by RADIUS, and a positive, valid MAC address authentication is cached in the Public Spot, then the Public Spot starts a new session for that user and forwards the associated data packets.
- If a provider chooses to check the MAC address with the RADIUS server, but does not have a valid authentication for the MAC address saved in the cache of the Public Spot, the Public Spot starts authentication on the corresponding RADIUS server. After a positive response, the Public Spot starts a new session for that user and forwards the associated packages.
- All of the above checks are unsuccessful, the Public Spot directs the user to the login page.

### Authentication of the MAC address by RADIUS

If the MAC address of a WLAN client requesting to associate is not included in the list of permissible addresses, the Public Spot can alternatively authenticate the address via a RADIUS server.

To enable RADIUS authentication, the administrator selects one of the RADIUS servers that has defined in the device and saved to the list of providers.

In addition, the administrator defines a lifetime for the rejected MAC addresses. This lifetime is used by the Public Spot to prevent the RADIUS server from being flooded with repeated requests for MAC addresses which cannot be authenticated (without login) via the RADIUS server or MAC address table.

If a MAC address authentication is rejected by the RADIUS server, the Public Spot saves this rejection for the lifetime defined here. The Public Spot responds to further requests for the same MAC address directly and without forwarding them to the RADIUS server first.

### Configuration in LANconfig

For the configuration in LANconfig, you can find the parameters for the authentication of the clients using the MAC address in the dialog **Public Spot > Users > MAC authenticated users**.

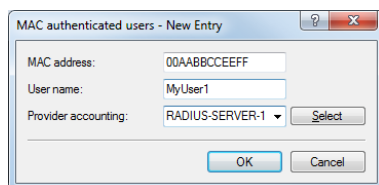

### Automatic authentication via WISPr

Your device provides an interface for authentication via WISPr. The **WISPr** standard is the technological predecessor of the 802.11u and Hotspot 2.0 specifications. The acronym stands for **Wireless Internet Service Provider roaming** and designates both a process and a protocol that allow users of WLAN enabled devices to roam seamlessly between the WLANs of different operators – and, therefore, between their Internet service providers. The idea behind it is similar to that of 802.11u and Hotspot 2.0; however, it requires more comprehensive support by the respective users.

Using the WISPr protocol, you can provide logins and network usage on your hotspot in a manner similar to Hotspot 2.0, even for end devices that no longer support Hotspot 2.0. The prerequisite is that your service provider provides the necessary infrastructure. Support for the user's device is provided either by the operating system or a suitable app (smart client). This client handles authentication to the hotspot for the user. If no credentials are available for the relevant network, the client queries the user for valid credentials at the system level. In any case, this eliminates the user having to log in via a login web page in the browser.

Because of its age, almost all current end devices with iOS, Android and Windows 8 support the WISPr protocol. In addition, larger WLAN Internet service providers often have their own apps to make the login for their clients easier: These apps include a preconfigured database of the provider's own hotspots and, optionally, those of their roaming partners. The authentication process corresponds to the following schema:

1. A customer installs his provider's hotspot app to act as a client, which provides a database of preconfigured hotspot SSIDs.

2. The client connects automatically with one of the hotspots and sends a HTTP-GET-Request to a random URL to test if direct Internet access is available or the Public Spot requires authentication.
3. In HTTP-Redirect the hotspot sends a WISPr-XML-Tag with the Login-URL.
4. The client sends its login data to the Login-URL in an HTTP-Post.

Example for an XML-Tag in redirect:

```
<HTML>
<?xml version="1.0" encoding="UTF-8"?>
 <WISPAccessGatewayParam
xmlns:xsi="http://www.w3.org/2001/XMLSchema-instance"
 xsi:noNamespaceSchemaLocation="http://www.acmewisp.com/WISPAccess
GatewayParam.xsd">
 <Redirect>
 <AccessProcedure>1.0</AccessProcedure>
 <AccessLocation>Hotel Contoso Guest Network</AccessLocation>
 <LocationName>Hotel Contoso</LocationName>
 <LoginURL>https://captiveportal.com/login</LoginURL>
 <MessageType>100</MessageType>
 <ResponseCode>0</ResponseCode>
 </Redirect>
</WISPAccessGatewayParam>
</HTML>
```

 In order to use WISPr, the device must have an SSL certificate and a private key installed. Further information about loading these objects on your device can be found in the LANCOM techpaper "Certificate Management in Public Spots". The certificate must either be signed by a trusted authority or – if it is a self-signed certificate – be imported as a trusted certificate on the client. Otherwise the client will reject the login via WISPr.

### Configuring WISPr

Configure the WISPr function of your device in the menu **Public Spot > WISPr**.

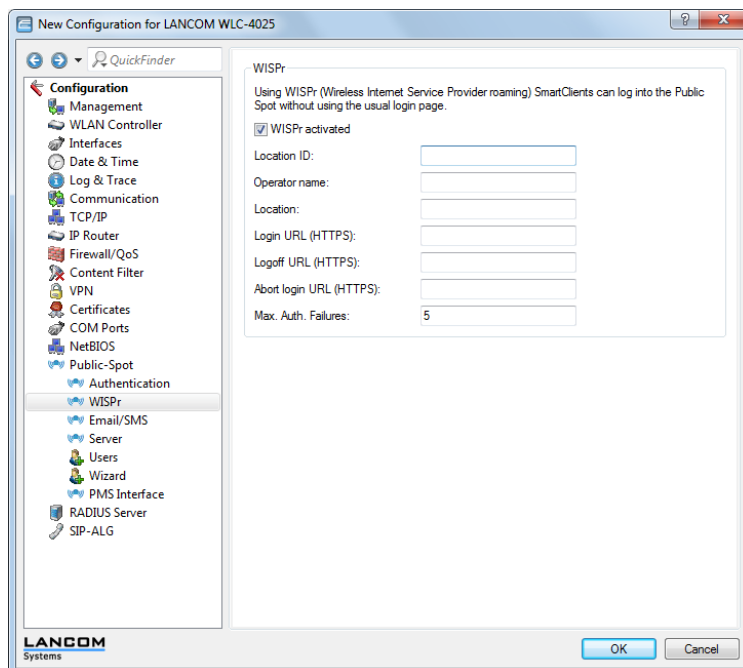

In this window you have the following options:

- **WISPr activated:** Enable or disable the WISPr function for the device.



- **Location ID:** Use this ID to assign a unique location number or ID for your device, for example, in the format `isocc=<ISO_Country_Code>,cc=<E.164_Country_Code>,ac=<E.164_Area_Code>,network=<SSID/ZONE>`
- **Operator name:** Enter the name of the hotspot operator, e.g., `providerX`. This information helps the user to manually select an Internet service provider.
- **Location:** Describe the location of your device, e.g., `CafeX_Market3`. This helps to better identify a user in your hotspot.
- **Login URL (HTTPS):** Enter the HTTPS address, that the WISPr client uses to transfer the credentials to your Internet service provider. Any external URL can be entered or the LANCOM Public Spot itself. If the LANCOM Public Spot should authenticate users using WISPr, enter the URL in the format `https://<FQDN-of-the-LANCOM>/wisprlogin`. For "wisprlogin" in the example, any freely defined path can be used.
- **Logoff URL (HTTPS):** Enter the HTTPS address that a WISPr client uses for logging off at your Internet service provider. The same rules apply as for the login URL.
- **Abort login URL (HTTPS):** Enter the HTTPS address to which the device forwards a WISPr client if authentication fails. The same rules apply as for the login URL.



The three URLs must be different, if the Public Spot is used in the LANCOM domain, for example:

- Login URL: `https://<FQDN-of-the-LANCOM>/wisprlogin`
- Logoff URL: `https://<FQDN-of-the-LANCOM>/wisprlogoff`
- Abort-Login-URL: `https://<FQDN-of-the-LANCOM>/wisprabort`

Finally, for test purposes, you can also configure an URL with IP addresses. In a production system, the client will check the FQDN of the certificate!

- **Max. auth. failures:** Enter the maximum number of failed attempts which the login page of your Internet service provider allows. If the Public Spot is used, the Public Spot rejects further login attempts by the specified client after this number of failed attempts.

## IEEE 802.11u and Hotspot 2.0

As of LCOS 8.82, your device supports WLAN connections according to the IEEE 802.11u standard and—based on that—the Hotspot 2.0 specification. Using 802.11u you have the option to implement automatic authorization and authentication of your users on a local WLAN network (for example, within your company) or a Public Spot network. The prerequisite for this is that the relevant stations (smartphones, tablet PCs, notebooks, etc.) also support connections for 802.11u and Hotspot 2.0. In detail, the following functions are offered:

### ■ Automatic network selection

In a 802.11u-enabled environment, the user does not have to manually detect and select an SSID. Instead, the client independently searches for and selects a suitable Wi-Fi network by automatically requesting and evaluating the operator and network data of all 802.11u-enabled access points that are in range. A previous login to the access point is not required.

Hotspot 2.0 stations also have the ability to retrieve information about the services available in a Wi-Fi network. If specific services that are relevant for a user (e.g., connections via HTTP, VPN or VoIP) are not available for a Wi-Fi network, any networks that do not meet the criteria are excluded from further searches. This ensures that users are always connected to the optimal network.

### ■ Automatic authentication and authorization

In 802.11u-enabled environments, the station automatically carries out the user's login if the necessary credentials are available. Authentication can be done, for example, using a SIM card, a username and password, or a digital certificate. Repetitive manual input of the credentials by the user in a login screen is no longer necessary. After successful authentication, the user can immediately use the desired services.

### ■ Seamless handover

Connections according to 802.11u and in conjunction with 802.21 facilitate the uninterrupted exchange of data connections between different network types. This enables users to switch their stations seamlessly from a cellular

network to a WLAN network as soon as they get within range of a Hotspot 2.0 zone—and vice versa. The same is true for the transfer between two different operators if, for example, the user goes from one homogeneous network to another during a bus trip

- **Automatic roaming**

Connections as per 802.11u facilitate roaming between different operator networks. If a user is in range of a Hotspot 2.0 zone of an operator for which he does not have any credentials, his station still has the option to switch to its home network. Authentication at a third-party Hotspot 2.0 zone is handled by the operator's roaming partner, which then allows the user to access the third-party Wi-Fi network. This is interesting not only in areas where there are only single network operators with access points, it is also especially attractive for people traveling abroad.

**Example:** For example, a user who is in transit in the city with his 802.11u-enabled smartphone (station) can enable the WLAN feature to browse the Internet. The station then starts trying to find all available Wi-Fi networks in the area. If any of the access points offer 802.11u, the station selects the one network that best fits the required service based on the operator and network information that was previously obtained, for example, from a hotspot offering Internet access from its own cellular network company. In this case, the subsequent authentication can be performed automatically via the SIM card so that the user does not need to intervene at any time during the process. The encryption method selected for the connection – e.g., WPA2 – is unaffected.

In summary, connections according to 802.11u and with Hotspot 2.0 enabled combine the security features and performance of classic Wi-Fi hotspots with the flexibility and simplicity of data cellular network connections. At the same time, they relieve the cellular networks by redistributing data traffic (and possibly also telephony) to the network connections and frequency bands offered by access points.

### Hotspot operators and service providers

The Hotspot 2.0 specification of the Wi-Fi Alliance differentiates between hotspot operators and hotspot service providers: A **hotspot operator** only operates one Wi-Fi network, while a **hotspot service provider** (SP) provides the connection for the user to the Internet or a cellular network. Of course, it is possible for an operator to also be an SP. However, in all other cases, a hotspot operator requires the corresponding roaming agreements with an SP or a group of multiple SPs (called a roaming consortium). Only when an operator has made these agreements are the various roaming partners' customers able to authenticate with the hotspot operator. Each service provider operates its own AAA infrastructure. A hotspot communicates this list of possible roaming partners and the name of the hotspot operator using ANQP (see functional description).

### Functional description

The **802.11u** standard is the base standard of IEEE. This standard essentially expands access points or hotspots with the ability to broadcast so-called **ANQP data packets** (Advanced Message Queuing Protocol) in its broadcast signals. ANQP is a query/response protocol that a device can use to request a range of information about the hotspot. This includes both meta-data, such as information about the owner and the venue, as well as information on the underlying network, such as information on operator domains, roaming partners, authentication methods, forwarding addresses, etc. All 802.11u-enabled devices in range have the ability to request these data packets without a prior login to the access point in order to select a network based on the network information.

The Wi-Fi Alliance has added further ANQP elements to the standard, and markets this specification as **Hotspot 2.0**. This Hotspot 2.0 function merely adds additional elements to the standard, which the device can use as criteria for selecting its network. These criteria include, for example, information about the services and WAN metrics available at the hotspot. The associated certification program is called Pass Points™. Certain LANCOM access points are Passpoint™ CERTIFIED by the Wi-Fi Alliance.

The ANQP data packets are the central information element of the 802.11u standard. However, to signal the support for 802.11u and to transmit data packets, further elements are required for the operation of 802.11u:

- The signaling of 802.11u support in the beacons and probes of a hotspot are done by the element known as the **Interworking element**. In this element, the initial basic network information—such as the network classification, Internet availability (Internet bit) and the OI of the roaming consortium and/or of the operator—are already included. At the same time, it is used by 802.11-enabled devices as an initial screening criterion when detecting a network.

- ANQP data packets are transferred within the so-called GAS containers. **GAS** stands for Generic Advertisement Service, and is the name of generic containers that allow a device to request additional internal and external information for the network selection from the hotspot, in addition to the information in the beacons. The GAS containers are transmitted on layer 2 by what are referred to as public action frames.

### Login by an 802.11u-enabled client at a Hotspot 2.0

The following functional description schematically illustrates the selection and login process of an 802.11u-enabled device at a Hotspot 2.0.

#### Login via username/password or digital certificate

1. The hotspots reply with an ANQP response, which contains, among other things, the name of the hotspot operator and a list of NAI realms, which list all available roaming partners (service provider, abbreviated SP).
2. The device loads the locally stored credentials from the WLAN profiles or installed certificates that were set up by the user, and compares the local realms with the NAI realm lists obtained in (2).
  - a. If the device successfully finds one, it knows that it can be authenticated successfully on the relevant Wi-Fi network.
  - b. If the device successfully finds more than one, the selection of a Wi-Fi network is made based on the user's preference list. This list defines the preferred order of operators in conjunction with the potential roaming partners. In this case, the device compares the operator names listed under (2) with the list, and selects the operator with the highest priority.
3. The device authenticates itself with its local credentials at the hotspot of the preferred operator for the appropriate SP. The access point then transmits this data over its SSPN interface (Subscription Service Provider Network) to an AAA system responsible for authentication. The authentication is performed using the authentication method determined by the SP. The authentication via username/password uses EAP-TTLS, and authentication via digital certificate uses EAP-TLS.

#### Login via (U)SIM

1. In contrast to the login via username/password or digital certificate, a device with a (U)SIM does not request the list of NAI realms in its ANQP requests, but rather the 3GPP Cellular Network Information. The ANQP responses contain the cellular network information list of all cellular network providers for which the access point offers authentication.
2. The device loads the parameters for the cellular network from its local (U)SIM card, and compares it with the data retrieved from the cellular network information lists. The list comparison and selection of a preferred provider network is performed analogous to the login via username/password or digital certificate.
3. The device authenticates itself with its local credentials at the hotspot of the preferred operator for the appropriate cellular network company. The hotspot then transmits this data over its SSPN interface (Subscription Service Provider Network) to an AAA system responsible for the authentication. The presence of a (U)SIM card changes the possible authentication method for the device to EAP-SIM or EAP-AKA.
4. The AAA system verifies the credentials for authentication via the interface MAP (Mobile Application Part) at the HLR server (Home Location Register) of the cellular network company.

If authentication is successful, the device gets access to the WLAN network either via hotspot (credentials for the operator's network are available) or automatic roaming (credentials for the operator's network are not available).

If there are multiple authentication options available for the device (e.g., SIM card and username/password), it has the option of using the preferred EAP authentication method and, therefore, the preferred credentials based on the NAI realm or cellular network information list.

### Recommended general settings

The Hotspot 2.0 specification recommends the following general settings for the 802.11u operator:

- WPA2-Enterprise Security (802.1x) enabled
- Authentication using EAP with the corresponding variant:
  - EAP-SIM/EAP-AKA for authentication with SIM / USIM card

- EAP-TLS for authentication with a digital certificate
- EAP-TTLS for authentication with a username and password
- Enabled and properly configured ARP proxy
- Disabled multicasts and broadcast in cellular networks (new in LCOS 8.82)
- Non-approved data traffic between the cellular network devices (Layer 2 traffic inspection and filtering). The corresponding settings can be found in LANconfig under **Wireless LAN > Security**.
- Enabled and implemented firewall on the access router, which provides Internet access

**Configuration menu for IEEE 802.11u / Hotspot 2.0**

You can find the configuration menu for IEEE 802.11u and Hotspot 2.0 under **Configuration > Wireless LAN > IEEE 802.11u**.

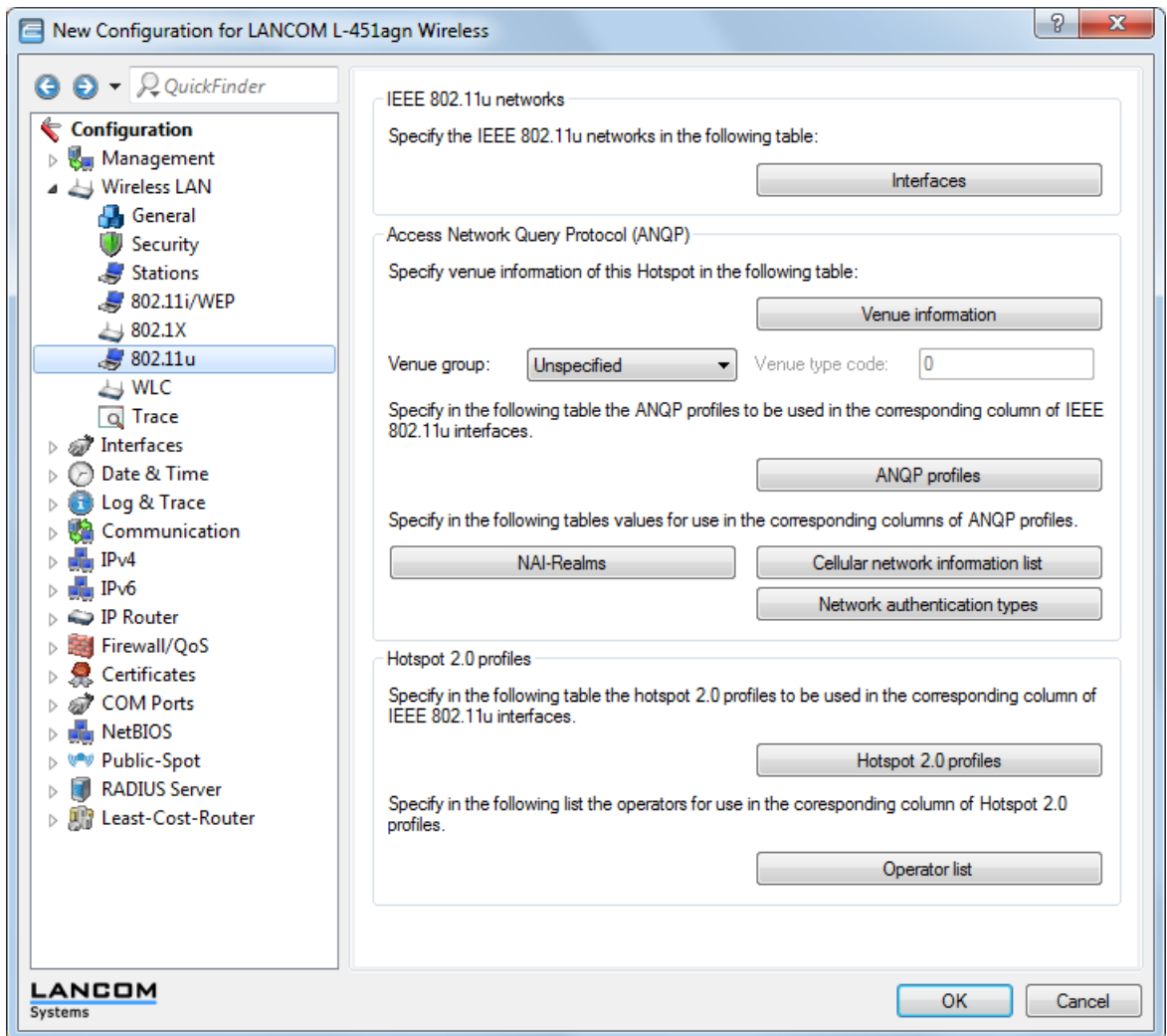

The device offers the ability to individually enable or disable and configure the support the IEEE 802.11u standard as well as the Hotspot 2.0 functionality for each logical WLAN interface using the button **Interfaces**.

Some of the parameters that need to be configured are located in so-called "profiles". Using profiles, you can group different rows in lists, which you only have to reference from the other windows. Essentially, these are profiles for ANQP data packets and Hotspot 2.0. The relationships between the profile lists is as follows:

```
|-- Interfaces
 |-- ANQP-Profiles
 |-- NAI-Realms
```

```

|-- Cellular-Network-Information-List
|-- Network-Authentication-Types
|-- Hotspot 2.0 Profiles
|-- Operator-List

```

### Activating interfaces

The table **Interfaces** is the highest administrative level for 802.11u and Hotspot 2.0. Here you have the option of enabling or disabling functions for each interface, assigning them different profiles, or modifying general settings.

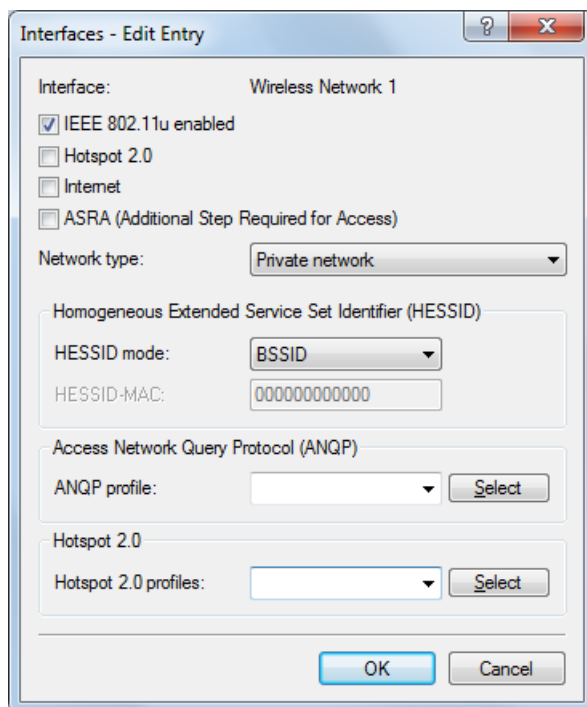

In order to edit the entries in the table **Interfaces**, click on the button **Edit....** The entries in the edit window have the following meaning:

- **Interface:** Name of the logical WLAN interface that you are currently editing.
- **IEEE 802.11u enabled:** Enable or disable support for connections according to IEEE 802.11u at the appropriate interface. If you enable support, the device sends the interworking element in beacons/probes for the interface or for the associated SSID, respectively. This element is used as an identifying feature for IEEE 802.11u-enabled connections: It includes, for example, the Internet bit, the ASRA bit, the HESSID, and the location group code and the location type code. These individual elements use 802.11-enabled devices as the first filtering criteria for network detection.
- **Hotspot 2.0:** Enable or disable the support for Hotspot 2.0 according to the Wi-Fi Alliance® at the appropriate interface. Hotspot 2.0 extends the IEEE standard 802.11u with additional network information, which stations can request using an ANQP request. These include, for example, the operator-friendly name, the connection capabilities, operating class and WAN metrics. Using this additional information, stations are in a position to make an even more selective choice of Wi-Fi network.
- **Internet:** Select whether the Internet bit is set. Over the Internet-bit, all stations are explicitly informed that the Wi-Fi network allows Internet access. Enable this setting if services other than internal services are accessible via your device.



Using this function you only communicate the availability of an Internet connection. You configure the corresponding regulations on the firewall, irrespective of this option.

- **ASRA - Additional steps for access required:** Select whether the ASRA bit (Additional Step Required for Access) is set. Using the ASRA bit explicitly informs all stations that further authentication steps are needed to access the

Wi-Fi network. Enable this setting if you have, for example, set up online registration, additional authentication, or a consent form for your terms of use on your web site.



Please remember to specify a forwarding address in the **Network authentication types** table for the additional authentication and/or **WISPr** for the Public Spot module if you set the ASRA bit.

- **Network type:** Select a network type from the available list which most closely describes the Wi-Fi network behind the selected interface. Based on the setting made here, the user has the option to limit network detection of their devices to specific network types. Possible values include:
  - `Private network`: Describes networks which are blocked to unauthorized users. Select this type, for example, for home networks or corporate networks where access is limited to employees.
  - `Private with guest access`: Similar to `Private network`, but with guest access for unauthorized users. Select this type, for example, for corporate networks where visitors may use the Wi-Fi network in addition to employees.
  - `Chargeable public network`: Describes public networks that are accessible to everyone and can be used for a fee. Information about fees may be available through other channels (e.g.: IEEE 802.21, HTTP/HTTPS or DNS forwarding). Select this type, for example, for hotspots in shops or hotels that offer fee-based Internet access.
  - `Free public network`: Describes public networks that are accessible to everyone and for which no fee is payable. Select this type, for example, for hotspots in public, local and long-distance transport, or for community networks where Wi-Fi access is an included service.
  - `Personal device network`: In general, it describes networks that connect wireless devices. Select this type, for example, for digital cameras that are connected to a printer via WLAN.
  - `Emergency services only network`: Describes networks that are intended for, and limited to, emergency services. Select this type, for example, for connected ESS or EBR systems.
  - `Test or experimental`: Describes networks that are set up for testing purposes or are still in the setup stage.
  - `Wildcard`: Placeholder for previously undefined network types.
- **HESSID mode:** Specify where the device gets its HESSID for the homogeneous ESS. A homogeneous ESS is defined as a group of a specific number of access points, which all belong to the same network. The MAC address of a connected access point serves as a globally unique identifier (HESSID). The SSID can not be used as an identifier in this case, because different network service providers can have the same SSID assigned in a hotspot zone, e.g., by common names such as "HOTSPOT". Possible values for the HESSID mode include:
  - `BSSID`: Select this item to set the BSSID of the device as the HESSID for your homogeneous ESS.
  - `User`: Select this item to manually assign a HESSID.
  - `None`: Select this item in order to not assign any homogeneous ESS and to isolate it from the device network.
- **HESSID-MAC:** If you selected the setting `user` for the **HESSID mode**, enter the HESSID of your homogeneous ESS as a 6-octet MAC address. Select the BSSID for the HESSID for any access point in your homogeneous ESS in capital letters and without separators, e.g., `008041AEFD7E` for the MAC address `00:80:41:ae:fd:7e`.



If your device is not present in multiple homogeneous ESS's, the HESSID is identical for all interfaces

- **ANQP profile:** Select an ANQP profile from the list. You create ANQP profiles in the configuration menu using the button of the same name.
- **Hotspot 2.0 profiles:** Select the Hotspot 2.0 profile from the list. You create the Hotspot 2.0 profiles in the configuration menu using the button of the same name.

### Configuring ANQP data packets

### Venue information and group

Using the table **Venue information** and the following dialogs **Venue group** and **Venue type code**, you manage the information about the access point's location.

In the event of a manual search, additional details on the **Venue information** help a user to select the correct hotspot. If more than one operator (e.g., multiple cafés) in a single hotspot zone uses the same SSID, the user can clearly identify the appropriate location using the venue information.

You can place your device in a predefined category using the **Venue group** and **Venue type code** – as opposed to the user-defined location information.

In order to edit the entries in the table **Venue information**, click on the button **Add...** The entries in the edit window have the following meaning:

- **Language:** You have the ability to specify custom information for the location of the access point for each language. The location name that matches your user's language will then be displayed. If a language is not available for a user, its station chooses one based, for example, on the default language.
- **Venue name:** Enter a short description of the location of your device for the selected language, for example:

```
Ice Café Valencia
123 Street
City, State 12345
```

The **Venue group** describes the environment where you operate the access point. You define them globally for all languages. The possible values, which are set by the venue group code, are specified in the 802.11u standard.

Using the **Venue type code**, you have the option to specify the details for the venue group. These values are also specified by the standard. The possible type codes can be found in the following table.

**Table 7: Overview of possible values for venue groups and types**

Venue group	Code = Venue type code
Unspecified	
Assembly	<ul style="list-style-type: none"> <li>■ 0 = unspecified assembly</li> <li>■ 1 = stage</li> <li>■ 2 = stadium</li> <li>■ 3 = passenger terminal (e.g., airport, bus station, ferry terminal, train station)</li> <li>■ 4 = amphitheater</li> <li>■ 5 = amusement park</li> <li>■ 6 = place of worship</li> <li>■ 7 = convention center</li> <li>■ 8 = library</li> </ul>

## 14 Public Spot

Venue group	Code = Venue type code
	<ul style="list-style-type: none"> <li>■ 9 = museum</li> <li>■ 10 = restaurant</li> <li>■ 11 = theater</li> <li>■ 12 = bar</li> <li>■ 13 = café</li> <li>■ 14 = zoo, aquarium</li> <li>■ 15 = emergency control center</li> </ul>
Business	<ul style="list-style-type: none"> <li>■ 0 = unspecified business</li> <li>■ 1 = doctor's office</li> <li>■ 2 = bank</li> <li>■ 3 = fire station</li> <li>■ 4 = police station</li> <li>■ 6 = post office</li> <li>■ 7 = office</li> <li>■ 8 = research facility</li> <li>■ 9 = law firm</li> </ul>
Educational:	<ul style="list-style-type: none"> <li>■ 0 = unspecified education</li> <li>■ 1 = primary school</li> <li>■ 2 = secondary school</li> <li>■ 3 = college</li> </ul>
Factory and industry	<ul style="list-style-type: none"> <li>■ 0 = unspecified factory and industry</li> <li>■ 1 = factory</li> </ul>
Institutional	<ul style="list-style-type: none"> <li>■ 0 = unspecified institution</li> <li>■ 1 = hospital</li> <li>■ 2 = long-term care facility (e.g., nursing home, hospice)</li> <li>■ 3 = rehabilitation clinic</li> <li>■ 4 = organizational association</li> <li>■ 5 = prison</li> </ul>
Commerce	<ul style="list-style-type: none"> <li>■ 0 = unspecified commerce</li> <li>■ 1 = retail store</li> <li>■ 2 = food store</li> <li>■ 3 = auto repair shop</li> <li>■ 4 = shopping center</li> <li>■ 5 = gas station</li> </ul>
Halls of residence	<ul style="list-style-type: none"> <li>■ 0 = unspecified residence hall</li> <li>■ 1 = private residence</li> <li>■ 2 = hotel or motel</li> <li>■ 3 = student housing</li> <li>■ 4 = guesthouse</li> </ul>
Warehouse	<ul style="list-style-type: none"> <li>■ 0 = unspecified warehouse</li> </ul>
Utility and miscellaneous	<ul style="list-style-type: none"> <li>■ 0 = unspecified service and miscellaneous</li> </ul>
Vehicular	<ul style="list-style-type: none"> <li>■ 0 = unspecified vehicle</li> <li>■ 1 = passenger or transport vehicles</li> <li>■ 2 = aircraft</li> <li>■ 3 = bus</li> <li>■ 4 = ferry</li> <li>■ 5 = ship or boat</li> <li>■ 6 = train</li> </ul>



Venue group	Code = Venue type code
Outdoor	<ul style="list-style-type: none"> <li>■ 7 = motorcycle</li> </ul>
	<ul style="list-style-type: none"> <li>■ 0 = unspecified outdoor</li> </ul>
	<ul style="list-style-type: none"> <li>■ 1 = municipal Wi-Fi network (wireless mesh network)</li> </ul>
	<ul style="list-style-type: none"> <li>■ 2 = city park</li> </ul>
	<ul style="list-style-type: none"> <li>■ 3 = rest area</li> </ul>
	<ul style="list-style-type: none"> <li>■ 4 = traffic control</li> </ul>
	<ul style="list-style-type: none"> <li>■ 5 = bus stop</li> </ul>
	<ul style="list-style-type: none"> <li>■ 6 = kiosk</li> </ul>

## ANQP profiles

Using this table you manage the profile lists for ANQP. **ANQP profiles** offers you the ability to group certain ANQP elements and to independently assign logical WLAN interfaces in the table **Interfaces**. These elements include, for example, information about your OIs, domains, roaming partners and their authentication methods. Some of the elements are located in other profile lists.

In order to edit the entries in the table **ANQP profiles**, click on the button **Add...** The entries in the edit window have the following meaning:

- **Name:** Assign a name for the ANQP 2.0 profile here. This name will appear later in the interfaces table in the selection for ANQP profiles.
- **Beacon OUI:** Organizationally Unique Identifier, abbreviated as OUI, simplified as OI. As the hotspot operator, you enter the OI of the roaming partner with whom you have agreed a contract. If you are the hotspot operator as well as the service provider, enter the OI of your roaming consortium or your own OI. A roaming consortium consists of

a group of service providers which have entered into mutual agreements regarding roaming. In order to get an OI, this type of consortium – as well as an individual service provider – must register with IEEE.

It is possible to specify up to 3 parallel OIs, in case you, as the operator, have roaming agreements with several partners. Multiple OIs can be provided in a comma-separated list, such as 00105E, 00017D, 00501A.

**!** This device transmits the specified OI(s) in its beacons. If a device should transmit more than 3 OIs, these can be configured under **Additional OUI**. However, additional OIs are not transferred to a station until after the GAS request. They are not immediately visible to the stations!

- **Additional OUI:** Enter the OI(s) that the device also sends to a station after a GAS request. Multiple OIs can be provided in a comma-separated list, such as 00105E, 00017D, 00501A.
- **Domain name list:** Enter one or more domains that are available to you as a hotspot operator. Multiple domain names are separated by a comma separated list, such as providerX.org, provx-mobile.com, wifi.mnc410.provX.com. For subdomains it is sufficient to specify only the highest qualified domain name. If a user configured a home provider on his device, e.g., providerX.org, this domain is also assigned to access points with the domain name wi-fi.providerX.org. When searching for suitable hotspots, a station always prefers a hotspot from his home provider in order to avoid possible roaming costs.
- **NAI realm list:** Select an NAI realm profile from the list. You specify profiles for NAI realms in the configuration menu by clicking the button **NAI realms**.
- **Cellular list:** Select the cellular network identity from the list. You set the identities for cellular networks – similar to profiles – in the configuration menu using the button **Cellular network information list**.
- **Network authentication type list:** Select an authentication profile from the list. You specify profiles for network authentication in the configuration menu by clicking the button **Network authentication types**.

Additionally, using the telnet console or setup menu, you have the option to also display the type of available IP addresses, which they can obtain from the network after a successful authentication. You can access the relevant parameters **IPv4-Addr-Type** and **IPv6-Addr-Type** via the telnet path **Setup > IEEE802.11u > ANQP-General**.

### NAI realms

Using this table you manage the profile lists for the NAI realms. With these lists you have the ability to group certain ANQP elements. These include the realms of the hotspot operator and its roaming partners, as well as the associated authentication methods and parameters. Stations use the information stored in this list to determine whether they have the hotspot operator or one of its roaming partners have valid credentials.

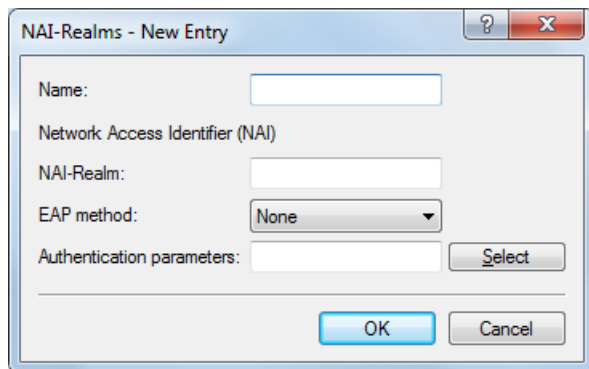

In order to edit the entries in the table **NAI realms**, click on the button **Add...** The entries in the edit window have the following meaning:

- **Name:** Assign a name for the NAI realm profile, such as the name of the service provider or service to which the NAI realm belongs. This name will appear later in the ANQP profile in the selection for **NAI realm list**.
- **NAI realm:** Enter the realm for the Wi-Fi network. The identification of the NAI realm consists of the username and a domain, which can be extended using regular expressions. The syntax for an NAI realm is defined in IETF RFC 2486 and, in the simplest case, is <username>@<realm>, for user746@providerX.org, and therefore the corresponding realm is providerX.org.

- **EAP method:** Select a language for the NAI realm from the list. EAP stands for the authentication profile (Extensible Authentication Protocol), followed by the corresponding authentication method Possible values include:
  - **EAP-TLS:** Authentication using Transport Layer Security (TLS). Select this setting when authentication via the relevant NAI realm is performed by a digital certificate that the user has to install.
  - **EAP-SIM:** Authentication via the Subscriber Identity Module (SIM). Select this setting when authentication via the relevant NAI realm is performed by the GSM Subscriber Identity Module (SIM card) of the station.
  - **EAP-TTLS:** Authentication via Tunneled Transport Layer Security (TTLS). Select this setting when authentication via the relevant NAI real is performed using a username and password. For security reasons, the connection is tunneled for this method.
  - **EAP-AKA:** Authentication using Authentication and Key Agreement (AKA). Select this setting when authentication via the relevant NAI realm is performed by the UMTS Subscriber Identity Module (USIM card) of the station.
  - **None:** Select this setting when the relevant NAI realm does not require authentication.
- **Authentication parameters:**

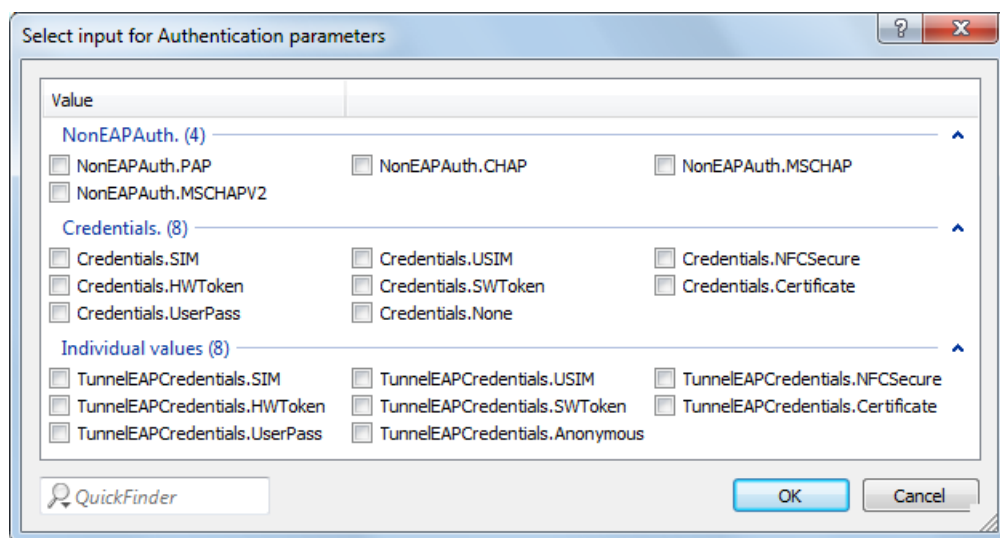

In the window that opens when you click the **Select** button, select the appropriate authentication parameters for the EAP method, such as EAP-TTLS `NonEAPAuth.MSCHAPV2`, `Credential.UserPass` or for EAP-TLS `Credentials.Certificate`. Possible values include:

**Table 8: Overview of possible authentication parameters**

Parameters	Sub-parameters	Comment
NonEAPAuth.		Identifies the protocol that the realm requires for phase 2 authentication:
	PAP	Password Authentication Protocol
	CHAP	Challenge Handshake Authentication Protocol, original CHAP implementation, specified in RFC 1994
	MSCHAP	Implementation of Microsoft CHAP V1, specified in RFC 2433
	MSCHAPV2	Implementation of Microsoft CHAP V2, specified in RFC 2759
Credentials.		Describes the type of authentication that the realm accepts:
	SIM	SIM card
	USIM	USIM card
	NFCSecure	NFC chip
	HWTOKEN*	Hardware token

Parameters	Sub-parameters	Comment
TunnelEAPCredentials.*	SoftToken*	Software token
	Certificate	Digital certificate
	UserPass	Username and password
	None	No credentials required
	SIM*	SIM card
	USIM*	USIM card
	NFCSecure*	NFC chip
	HWToken*	Hardware token
	SoftToken*	Software token
	Certificate*	Digital certificate
UserPass*	Username and password	
Anonymous*	Anonymous login	

\*) The specific parameter or sub-parameter is reserved for future uses within the framework of Passpoint™ certification, but currently is not in use.

### Cellular network information list

Using this table you manage the identity lists for cellular networks. With these lists you have the ability to group certain ANQP elements. These include the network and country codes of the hotspot operator and its roaming partners. Based on the information stored here, stations with SIM or USIM cards use this list to determine if the hotspot operator belongs to their cellular network company or has a roaming agreement with their cellular network company.

In order to edit the entries in the table **Cellular network information list**, click on the button **Add...**. The entries in the edit window have the following meaning:

- **Name:** Assign a name for the cellular network identity, such as an abbreviation of the network operator in combination with the cellular network standard used. This name will appear later in the ANQP profile in the selection for **Cellular list**.
- **Country code (MCC):** Enter the Mobile Country Code (MCC) of the hotspot operator or its roaming partners, consisting of 2 or 3 characters, e.g., 262 for Germany.
- **Network code (MNC):** Enter the Mobile Network Code (MNC) of the hotspot operator or its roaming partners, consisting of 2 or 3 characters.

### Network authentication types

Using this table, you manage addresses to which the device forwards stations for an additional authentication step after the station has been successfully authenticated by the hotspot operator or any of its roaming partners. Only one forwarding entry is allowed for each authentication type.

! Please remember to set the ASRA bit in the **Interfaces** table if you set up an additional authentication step.

In order to edit the entries in the table **Network authentication types**, click on the button **Add...** The entries in the edit window have the following meaning:

- **Name:** Assign a name for the table entry, for example, *Accept Terms & Conditions*. This name will appear later in the ANQP profile in the selection for **Network auth. type list**.
- **Authentication type:** Choose the context from the list, which applies before forwarding. Possible values include:
  - *Accept terms & conditions*: An additional authentication step is set up that requires the user to accept the terms of use.
  - *Online enrollment*: An additional authentication step is set up that requires the user to register online first.
  - *HTTP redirection*: An additional authentication step is set up to which the user is forwarded via HTTP.
  - *DNS redirection*: An additional authentication step is set up to which the user is forwarded via DNS.
- **Redirect URL:** Enter the address to which the device forwards stations for additional authentication.

## Configuring Hotspot 2.0

### Hotspot 2.0 profiles

Using this table you manage the profile lists for the Hotspot 2.0. **Hotspot 2.0 profiles** offers you the ability to group certain ANQP elements (from the Hotspot 2.0 specification) and to independently assign logical WLAN interfaces in the table **Interfaces**. These include, for example, the operator-friendly name, the connection capabilities, operating class and WAN metrics. Some of the elements are located in other profile lists.

In order to edit the entries in the table **Hotspot 2.0 profiles**, click on the button **Add...** The entries in the edit window have the following meaning:

- **Name:** Assign a name for the Hotspot 2.0 profile here. This name will appear later in the interfaces table in the selection for the Hotspot 2.0 profile.
- **Operator name list:** Select the profile of a hotspot operator from the list. You specify profiles for hotspot operators in the configuration menu by clicking the **Operator list**.

- **Connection capabilities:**

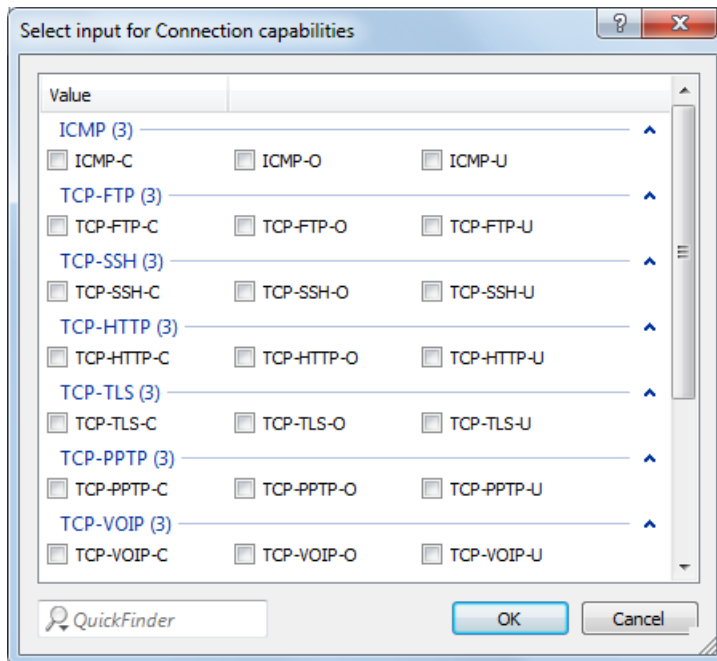

Click the **Select** button and enter the connection capabilities for each service in the window that opens. Before joining a network, stations use the information stored in this list to determine whether your hotspot even allows the required services (e.g., Internet access, SSH, VPN). For this reason, the fewest possible entries should be entered with the status "unknown". Possible status values for each of these services are "closed" (-C), "Open" (-O) or "unknown" (-U):

- ICMP: Specify whether to allow the exchange of information and error messages via ICMP.
- TCP-FTP: Specify whether to allow file transfers via FTP.
- TCP-SSH: Specify whether to allow encrypted connections via SSH.
- TCP-HTTP: Specify whether to allow Internet connections via HTTP/HTTPS.
- TCP-TLS: Specify whether to allow encrypted connections via TLS.
- TCP-PPTP: Specify whether to allow the tunneling of VPN connections via PPTP.
- TCP-VOIP: Specify whether to allow Internet telephony via VoIP (TCP).
- UDP-IPSEC-500: Specify whether to allow IPsec via UDP and port 500.
- UDP-VOIP: Specify whether to allow Internet telephony via VoIP (UDP).
- UDP-IPSEC-4500: Specify whether to allow IPsec via UDP and port 4500.
- ESP: Specify whether to allow ESP (Encapsulating Security Payload) for IPsec.

If you do not know if a service is available and its ports are open or closed on your network, or you consciously do not want to make any entry for the status, select a -U setting.

⚠ Using this dialog, you do not define permissions! The stations only use the entries to determine whether to join a network via your device. You configure specific access permissions for your network with other device functions, such as the firewall/QoS.

- **Operating class:** Enter the code for the global operating class of the access point. Using the operating class, you inform a station on which frequency bands and channels your access point is available. Example:

- 81: Operation at 2.4 GHz with channels 1-13
- 116: Operation at 40 MHz with channels 36 and 44

Please refer to the IEEE standard 802.11-2012, Appendix E, Table E-4, for the operating class that corresponds to your device: Global operating classes, available at [standards.ieee.org](http://standards.ieee.org).

## Operator list

Using this table you manage the plain text name of the hotspot operator. An entry in this table offers you the ability to send a user-friendly operator name to the stations, which they can then display instead of the realms. However, whether they actually do that depends on their implementation.

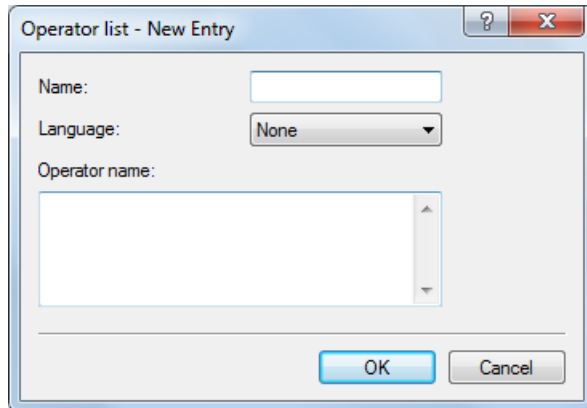

In order to edit the entries in the table **Operator list**, click on the button **Add...**. The entries in the edit window have the following meaning:

- **Name:** Assign a name for the entry, such as an index number or combination of operator-name and language.
- **Language:** Select a language for the hotspot operator from the list.
- **Operator name:** Enter the plain text name of the hotspot operator.

## XML interface

In order to be able to cover a wide range of Public Spot scenarios, the default authentication method of name and password is not sufficient by itself. Access and accounting models using key cards, dongles or prepaid credit cards often require additional access data, which the Public Spot in this form would be unable to manage.

The implemented XML interface connects the Public Spot and an external gateway. It directs the user data only to the gateway that handles the authentication and accounting, and it only sends information about the duration and limits of the user access to the Public Spot.

In this case, the Public Spot only performs the following tasks:

- Forward the user requests
- Restrict unauthorized access attempts
- Accept gateway commands to start and stop a session
- Accounting for sessions, if applicable

Since it is not realistic to implement all existing, and at times very specific scenarios with the associated gateway commands on the Public Spot, the XML interface was designed to be flexible and multi-purpose.

### Function

The communication between the XML interface and external gateway is processed as follows:

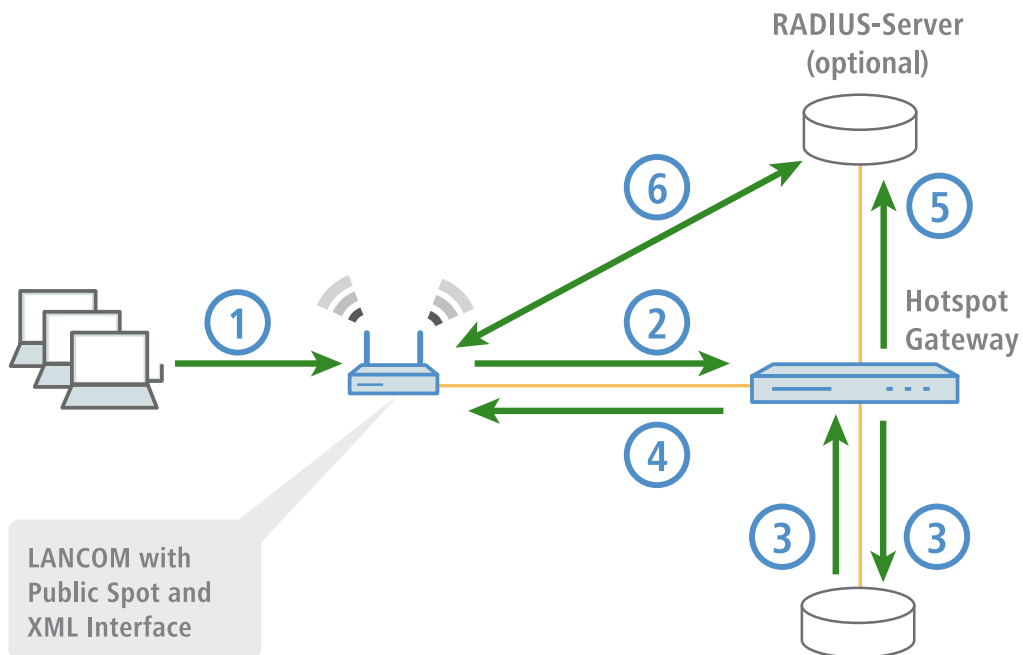

1. The user connects to the Public Spot's WLAN and sends an HTTP request to the Public Spot.
2. The Public Spot forwards the login procedure's HTTP request to the external hotspot gateway. The external hotspot gateway is located either in a freely accessible network provided by the Public Spot, or its address is included in the list of free hosts.

The Public Spot forwards the MAC address of the requesting Public Spot client to the external gateway. To implement this, navigate to **Public-Spot-Module > Page-Table**, set the **Type** to "Redirect" and suffix the **URL** with the parameter `?myvar=%m`.

**Example:** `http://192.168.1.1/?myvar=%m`

In this case, `myvar` is a freely selectable variable. The variable `%m` is vital here, as the Public Spot replaces this with the client's MAC address when forwarding the request.

3. The hotspot gateway checks the user's credentials and, if applicable, it can contact further systems to charging to credit card, for example.
4. The hotspot gateway sends an XML file with the user data to the Public Spot's XML interface. The external hotspot gateway contacts the device with the Public Spot XML interface using the URL `http://<Device-URL>/xmlauth`.

The Public Spot's XML interface analyses this file and initiates the corresponding actions. In the case of a login request, the XML interface inserts the user and the corresponding MAC address into the list of logged-on Public Spot users. In the case of a logout request, the XML interface removes the user from this list again. At the same time, the XML interface confirms the request by sending a corresponding XML file to the hotspot gateway.

In order for the Public Spot to be able to process the instructions in the XML file, a special administrator must be set up on the device who has the function right "Public-Spot -XML-interface". This hotspot gateway logs in to the Public Spot with this admin account.

While the user is logged in to the Public Spot, the XML interface and hotspot gateway can exchange status information about the current session in the form of XML files.

If the user has exhausted his online quota, the hotspot gateway will send a stop command to the XML interface, and then the Public Spot locks further access for that user. The XML interface also confirms that the login is blocked by sending the corresponding XML file to the hotspot gateway.



5. If the additional use of a RADIUS server is enabled, the hotspot gateway optionally creates a user in a RADIUS server.
6. The Public Spot sends relevant data to the RADIUS server throughout the session, for example to facilitate the accounting of the Public Spot usage. By default, the Public Spot uses its internal RADIUS server for this. If necessary, you can configure the device running the Public Spot to conduct forwarding to an external RADIUS server.

**!** Communications between the Public Spot and a hotspot gateway with the use of XML is not standardized. Configure the hotspot gateway according to the instructions in the [Commands](#) section in order for the Public Spot and hotspot gateway exchange the XML messages in the required form. XML messages are exchanged invisibly without a graphical user interface. You can use tools such as [cURL](#) to test the exchange of messages.

### Setting up the XML interface

The following section describes how to set up the XML interface.

**!** You need to have the "Supervisor" permission in order to create another administrator account.

1. Using **Management > Admin > Further administrators** you create a new administrator with the function right **Public Spot XML interface**.

This is the administrator account that the gateway uses to send XML files to the Public Spot XML interface.

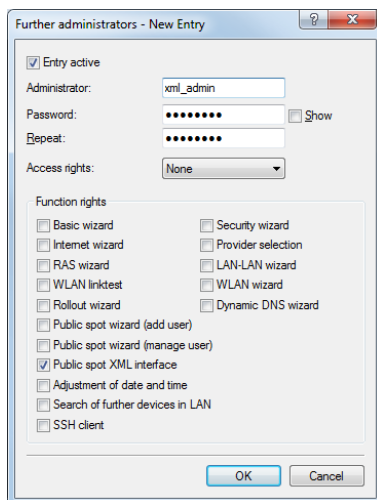

**!** The new administrator should not have any further Public Spot function rights, since they represent a potential security risk in combination with the XML interface (e.g., if the communication between XML sender and device is unencrypted).

2. You enable the XML interface in **Public Spot > Server** in the section **External hotspot gateway** and, if necessary, global RADIUS authentication for your Public Spot.
3. In the section **Allow access without authentication** click on the button **Free Networks** and add a new network. Enter the **Name/IP address** of the login page. In **Netmask** enter 255 . 255 . 255 . 255.

When defined as a free network, the user has direct access to the login page of the gateway without having to login to the Public Spot first.

4. Configure the gateway so that it sends the user's session data to the Public Spot XML interface as an XML file. For questions about configuring the gateway, please refer to the applicable service provider.

### Analyzing the XML interface using cURL

The following section describes the analysis of the XML interface with the open-source software cURL.

Client for URL, or cURL, is a command line application use for transferring files on a network without the use of a Web browser or FTP client. "cURL" is a component of many Linux distributions and is also available for other operating systems.

 To analyze the XML interface using cURL, you need an administrator account with the function right "Public Spot XML interface" for the Public Spot.

1. First download cURL and install or unpack it.
2. Start cURL with the console command `curl -X POST -H "Content-Type:text/xml" -d @filename http://user:pass@myhost/xmlauth/`

The parameters have the following meaning:

**@filename**

Path and name of the local XML file, e.g. the login request from the [examples](#).

**user**

Username with the function right titled "Public Spot XML interface". The XML feature does not work without this authentication.

**pass**

User password.

**myhost**

IP address or DNS name of LANCOM with the Public Spot XML interface

3. With Telnet you can use the command `trace # XML-Interface-PbSpot` to activate a trace that verifies whether XML requests were successful or error messages were received.

### Commands

The XML interface can process three types of requests and responses:

- Login
- Logout
- Status

An XML file can contain several requests or answers.

### Login

If the external gateway sends a "Login" request in an XML file, the Public Spot activates online access for the corresponding user. A "Login" request contains the attribute `COMMAND="RADIUS_LOGIN"`.

If the Public Spot does not use a RADIUS server, a "login" request prompts it to store the user and the associated MAC address directly in the internal Status table. As a result, the user is immediately authenticated in future, and there is no need to display a login page for entering the username and password.

When you operate a RADIUS server, a 'login' request can only be successfully processed if the login data of the corresponding user already exists on the RADIUS server.

 The Web API in the Public Spot provides you with a convenient tool for creating new Public Spot users on the LANCOM's internal RADIUS server. Further information about this is available in the Reference Manual under the section "Public Spot".

The XML interface can process the following XML elements for a request:

**SUB\_USER\_NAME**

User name

**SUB\_PASSWORD**

User password

**SUB\_MAC\_ADDR**

MAC address of the user's device Possible formats include:

- 00164115208c
- 00:16:41:15:20:8c
- 00-16-41-15-20-8c

The XML interface then sends the gateway a "Login" response, which can contain the following XML elements:

**SUB\_USER\_NAME**

User name

**SUB\_STATUS**

The current user status. The following values are possible:

- RADIUS\_LOGIN\_ACCEPT: Login successful
- RADIUS\_LOGIN\_REJECT: Login rejected

**SUB\_MAC\_ADDR**

MAC address of the user's device Possible formats include:

- 00164115208c
- 00:16:41:15:20:8c
- 00-16-41-15-20-8c

Some examples of XML files are given below:

**Login request**

The external gateway sends the data for the start of a session to the Public Spot:

```
<?xml version="1.0" encoding="ISO-8859-1"?>
<PUBLICSPOTXMLINTERFACE>
 <ACCESS_CUBE COMMAND="RADIUS_LOGIN">
 <SUB_USER_NAME>user2350</SUB_USER_NAME>
 <SUB_PASSWORD>5juchb</SUB_PASSWORD>
 <SUB_MAC_ADDR>00164115208c</SUB_MAC_ADDR>
 </ACCESS_CUBE>
</PUBLICSPOTXMLINTERFACE>
```

The Public Spot enables 'user2350' in the internal Status table.

**Login response:**

The XML interface sends a confirmation about the start of a session to the external gateway:

```
<?xml version="1.0" encoding="ISO-8859-1" ?>
<PUBLICSPOTXMLINTERFACE>
 <ACCESS_CUBE ID="WLC-4006_PM" IP="192.168.100.2"
 COMMAND="USER_STATUS">
 <SUB_STATUS>RADIUS_LOGIN_ACCEPT</SUB_STATUS>
 <SUB_MAC_ADDR>00:16:41:15:20:8b</SUB_MAC_ADDR>
 <SUB_USER_NAME>user2350</SUB_USER_NAME>
 <TXRATELIMIT>0</TXRATELIMIT>
 <RXRATELIMIT>0</RXRATELIMIT>
 <SECONDSEXPIRE>0</SECONDSEXPIRE>
 <TRAFFICEXPIRE>0</TRAFFICEXPIRE>
 <ACCOUNTCYCLE>0</ACCOUNTCYCLE>
```

```
<IDLETIMEOUT>0</IDLETIMEOUT>
</ACCESS_CUBE>
</PUBLICSPOTXMLINTERFACE>
```

### Logout

If the external gateway sends a "Logout" request in an XML file, the Public Spot blocks the corresponding user's online access. A "Logout" request contains the attribute `COMMAND="RADIUS_LOGOUT"`.

The XML interface can process the following XML elements for a request:

#### **SUB\_USER\_NAME**

User name

If the LANCOM receives this request and the Public Spot module discovers that this user is online with the corresponding MAC, then this user is logged out.

#### **SUB\_MAC\_ADDR**

MAC address of the user's device Possible formats include:

- 00164115208c
- 00:16:41:15:20:8c
- 00-16-41-15-20-8c

#### **TERMINATION\_CAUSE**

Reason for the user to log off

The XML interface then sends the gateway a "Logout" response, which can contain the following XML elements:

#### **SUB\_USER\_NAME**

User name

#### **SUB\_STATUS**

The current user status. The following values are possible:

- `RADIUS_LOGOUT_DONE`: Logout successful
- `RADIUS_LOGOUT_REJECT`: Logout rejected

#### **SUB\_MAC\_ADDR**

MAC address of the user's device Possible formats include:

- 00164115208c
- 00:16:41:15:20:8c
- 00-16-41-15-20-8c

#### **TERMINATION\_CAUSE**

Reason for blocking access

Some examples of XML files are given below:

#### **Logout request**

The external gateway sends the command for ending a session to the Public Spot:

```
<?xml version="1.0" encoding="ISO-8859-1"?>
<PUBLICSPOTXMLINTERFACE>
 <ACCESS_CUBE COMMAND="RADIUS_LOGOUT">
 <SUB_USER_NAME>user2350</SUB_USER_NAME>
 <SUB_PASSWORD>5juchb</SUB_PASSWORD>
 <SUB_MAC_ADDR>00164115208c</SUB_MAC_ADDR>
 <TERMINATION_CAUSE>Check-Out</TERMINATION_CAUSE>
```

```
</ACCESS_CUBE>
</PUBLICSPOTXMLINTERFACE>
```

**Logout response:**

The XML interface sends a confirmation about the end of a session to the external gateway:

```
<?xml version="1.0" encoding="ISO-8859-1" ?>
<PUBLICSPOTXMLINTERFACE>
 <ACCESS_CUBE ID="WLC-4006_PM" IP="192.168.100.2"
 COMMAND="USER_STATUS">
 <SUB_STATUS>RADIUS_LOGOUT_DONE</SUB_STATUS>
 <SUB_MAC_ADDR>00:16:41:15:20:8b</SUB_MAC_ADDR>
 <SUB_USER_NAME>user2350</SUB_USER_NAME>
 <TERMINATION_CAUSE>User logout request</TERMINATION_CAUSE>

 </ACCESS_CUBE>
</PUBLICSPOTXMLINTERFACE>
```

**Status**

The external gateway queries the current status of a user from the Public Spot with a "Status" request. A "Status" request contains the attribute `COMMAND="RADIUS_Status"`.

The XML interface can process the following XML elements for a request:

**SUB\_USER\_NAME**

User name

**SUB\_MAC\_ADDR**

MAC address of the user's device Possible formats include:

- 00164115208c
- 00:16:41:15:20:8c
- 00-16-41-15-20-8c

The XML interface then sends the gateway a "Status" response, which can contain the following XML elements:

**SUB\_USER\_NAME**

User name

**SUB\_MAC\_ADDR**

MAC address of the user's device Possible formats include:

- 00164115208c
- 00:16:41:15:20:8c
- 00-16-41-15-20-8c

**SUB\_STATUS**

The current user status. The following values are possible:

- `RADIUS_STATUS_DONE`: Status request successful
- `RADIUS_STATUS_REJECT`: Status request rejected, e.g. unknown user or MAC address

**SESSION\_TXBYTES**

Current sent data volume

**SESSION\_RXBYTES**

Current received data volume

**SESSION\_TXPACKETS**

Number of data packets sent so far

**SESSION\_RXPACKETS**

Number of data packets received so far

**SESSION\_STATE**

Current status of the session

**SESSION\_ACTUAL\_TIME**

Current time

Some examples of XML files are given below:

**Status request**

The external gateway sends the command for a status request to the Public Spot:

```
<?xml version="1.0" encoding="ISO-8859-1"?>
<PUBLICSPOTXMLINTERFACE>
 <ACCESS_CUBE COMMAND="RADIUS_STATUS">
 <SUB_USER_NAME>user2350</SUB_USER_NAME>
 <SUB_MAC_ADDR>00164115208c</SUB_MAC_ADDR>
 </ACCESS_CUBE>
</PUBLICSPOTXMLINTERFACE>
```

**Status response:**

The XML interface sends a status message to the external gateway:

```
<?xml version="1.0" encoding="ISO-8859-1" ?>
<PUBLICSPOTXMLINTERFACE>
 <ACCESS_CUBE ID="WLC-4006_PM" IP="192.168.100.2"
 COMMAND="USER_STATUS">
 <SUB_STATUS>RADIUS_STATUS_DONE</SUB_STATUS>
 <SUB_MAC_ADDR>00:16:41:15:20:8b</SUB_MAC_ADDR>
 <SUB_USER_NAME>user2350</SUB_USER_NAME>
 <SESSION_ID>2</SESSION_ID>
 <SESSION_TXBYTES>0</SESSION_TXBYTES>
 <SESSION_RXBYTES>0</SESSION_RXBYTES>
 <SESSION_TXPACKETS>0</SESSION_TXPACKETS>
 <SESSION_RXPACKETS>0</SESSION_RXPACKETS>
 <SESSION_STATE>Authenticated</SESSION_STATE>
 <SESSION_ACTUAL_TIME>0</SESSION_ACTUAL_TIME>
 </ACCESS_CUBE>
</PUBLICSPOTXMLINTERFACE>
```

**Interface for property management systems**

If you use a property management system (PMS), certain device types and series give you the option of connecting your Public Spot module with your PMS database via the PMS interface. If you operate a hotel, this offers you the possibility of automatically providing your guests with access to your Public Spot when they register. This access can optionally be free of charge or fee-based (using prepaid time credits), whereby all fees are charged to the guest's bill for their room. The last name, room number and, optionally, an additional security ID (for example, registration number or departure date) are used as login data.

In contrast to a voucher solution, using the PMS interface gives you the advantage of not requiring any additional administrative steps for the setup and management of a Public Spot user account. The device creates a user account by itself as soon as the user accesses the Public Spot and logs in with his registration data. Any future changes for this

guest (room change, departure date change, check-out, etc.), which affect registration, are retrieved autonomously from your PMS.

The following login methods are currently supported:

1. Voucher
2. PMS login
3. PMS login and voucher
4. E-mail
5. SMS

With login method (2), the login, for example, for hotel guests, can be based on the room number and last name, while you sell vouchers to your guests in your restaurant. Of course, even with the PMS interface enabled, you still have the option to issue vouchers, for example, for day guests or visitors.

---

 The login method is configured globally for each device, and is thus the same for all SSIDs or networks.

---

 The PMS interface currently only includes support for hotel property management systems from Micros Fidelio via TCP/IP.

---

 Currently, the PMS interface is only available for the following device types and series:

- LANCOM 1780 series
- LANCOM 1781 series
- LANCOM WLC-4006
- LANCOM WLC-4006+
- LANCOM WLC-4025
- LANCOM WLC-4025+
- LANCOM WLC-4100
- LANCOM 7100 VPN
- LANCOM 7100+ VPN
- LANCOM 9100 VPN
- LANCOM 9100+ VPN

### Functional description

If you enable the PMS interface and provide a free or fee-based login page, the Public Spot portal page displays new input fields, which guests can use to authenticate by entering their surname, the room number and, if applicable, a further security identifier. The type of this identifier is set in the Setup menu; options include a registration number or the guest's arrival/departure date. If you have allowed access to your hotspot as a fee-based service, a drop-down menu additionally appears, which guests use to select the prepaid time quota or tariff/rate that they want to buy (e.g. 1 min

for EUR 0.20, or 1 hours for EUR 1). The PMS working in the background automatically charges the costs to the room bill.

Every time a guest logs in to the Public Spot, the device initiates a comparison of the entered login data with that in the PMS. The PMS informs the device if it detects a valid match. The device then creates a new session for the guest and makes an entry in the corresponding accounting table (WEBconfig: **Status > PMS-Interface > Accounting**). The device records all hotel guests, and the corresponding prices, who have logged on via the PMS interface, irrespective of whether the connection is free or charged. The device then activates user access to the Internet.

A user with charged access can purchase additional time while logged on. Users who log off before the time quota expires can resume the session at a later time by selecting the corresponding field on the login page. The device stores the session until it becomes invalid, i.e. when the time quota is used up or when the PMS informs the device that the guest has departed. For a new login and synchronization with the PMS, the device recognizes that there is still a valid user account and continues using it instead of creating a new one.

If there is a change to the registration information (such as the room number), then an existing session initially remains unaffected. Only when the current session is closed and the guest logs on to the Public Spot again is it necessary to authenticate with the modified credentials. An exception occurs when a guest is checked-out of the PMS: In this case, the device immediately terminates an existing session.

**!** Your users should make sure that they log out properly from the Public Spot. Without a proper logout (caused by closing the browser, disconnecting the network, switching off the device, etc.) the user is considered to be still logged in. This can cause a problem for the user at login if you, as the Public Spot operator, have not allowed multiple logins.

Using *Station monitoring*, you can automatically log off these users after a specified idle time. This feature is off by default. However, for fee-based access, you absolutely should enable this. Otherwise, the device's automatic internal logout will only occur after the user account has expired, i.e., when the purchased time credit has been used up completely.



- ! A temporary logout from the Public Spot does not change the expiry time of a purchased time quota. It is not possible to "pause" a previously purchased time credit in order to restart it at a later point in time. The countdown starts as of the purchase of the time credit regardless of the login status.

### Configuring the PMS interface

Configure the PMS interface of your device in the menu **Public Spot > PMS-Interface**.

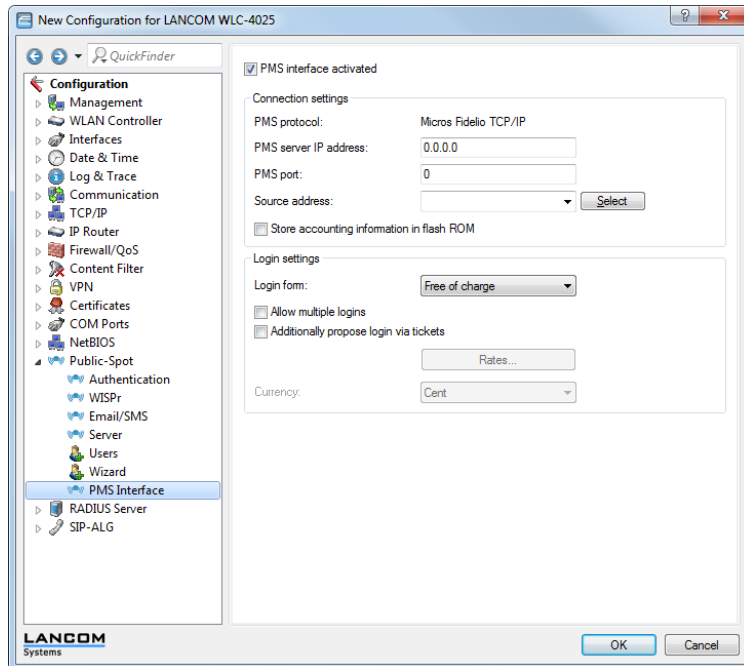

In this window you have the following options:

- **PMS interface activated:** Enable or disable the PMS interface for the device.
- **PMS protocol:** Identifies the protocol used by your property management system. Currently, only support for hotel property management systems from Micros Fidelio is available via TCP/IP.
- **PMS server IP address:** Enter the IPv4 address of your PMS server.
- **PMS port:** Enter the TCP port where your PMS server is accessible.
- **Sender address:** Click on the **Select** button, in order to configure another address where your PMS server sends its reply messages. By default, the PMS server sends its replies back to the IP address of your device without having to enter it here.

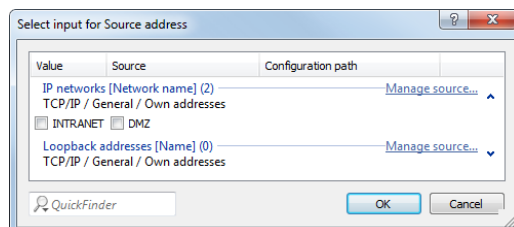

Possible formats for entering the address include:

- Name of the IP network (ARF network), whose address should be used.
- `INT` for the address of the first Intranet
- `DMZ` for the address of the first DMZ

---

! If an interface with the name "DMZ" already exists, the device will select that address instead.

- `LB0...LB15` for one of the 16 loopback addresses or its name

---

! The device always uses **unmasked** loopback addresses, even on masked remote stations!

- Any IPv4 address
- **Store accounting information in flash ROM:** Enable or disable whether your device stores accounting information in regular intervals on the internal flash-ROM. By default this occurs hourly, but you can change the interval using the setup menu. Enable this option in order to prevent a complete loss of accounting information in case of a power outage.

---

! Please note that frequent writing operations to this memory will reduce the lifetime of your device.

- **Login form:** Choose the login form that will be shown as a portal page for your PMS interface. Possible values include:
  - `Free-of-charge`: Choose this option if you offer your hotel guests free Internet access. Your hotel guests will still be required to authenticate on the hotspot on the portal page with their username, room number and, if required, an additional ID in order to prevent access to the Internet by unauthorized users.
  - `Subject to charge`: Choose this option if you offer your hotel guests fee-based Internet access. Your hotel guests will be required to authenticate on the hotspot on the portal page with their username, room number and select a tariff.
- **Allow multiple logins:** Enable or disable this if you want to allow a hotel guest to use the same credentials to login to the hotspot with multiple devices.
- **Additionally propose login via tickets:** Enable or disable whether you also want to allow login with vouchers in addition to login with the combination of username/room number.
- **Rates:** If you offer fee-based Internet access, you manage the tariff rates for accounting using this table.

- **Count:** Enter the rate for the time quota, for example, 1. Combined with the unit, this is the value shown in the screenshot above, e.g., 1 hour.
- **Unit:** Select the unit for the time quota from the list. Possible values include: `Minutes`, `Hours`, `Days`
- **Price** Enter the amount charged for the time quota. Combined with the unit, this is the value shown in the screenshot above, e.g., 50 Cent.

---

! A temporary logout from the Public Spot does not change the expiry time of a purchased time quota. It is not possible to "pause" a previously purchased time credit in order to restart it at a later point in time. The countdown starts as of the purchase of the time credit regardless of the login status.

- **Currency:** If you offer fee-based Internet access, select the currency that you use to bill the time quotas that you offer (time quotas are set up using the tariff table). This unit is also displayed on the portal page. Please note that this currency must match the one on the PMS server. Possible values include:
  - `Cent`
  - `Penny`

### Advanced settings

Advanced settings for the PMS interface are made on the console or in the setup menu. An overview of all additional parameters can be found in the [Appendix](#).

## 14.2.5 Default and customized authentication pages

By default, your device uses pre-installed templates for the login page and all other authentication pages that your user sees before, during and after a Public Spot session. However, you do have the option of adapting the individual web pages to your requirements and changing the design. You need basic HTML knowledge of DIV containers and cascading style sheets (CSS), in order to effectively change the structure and layout of the individual pages.

The following flow-chart shows an overview and interaction of all available authentication pages on your device:

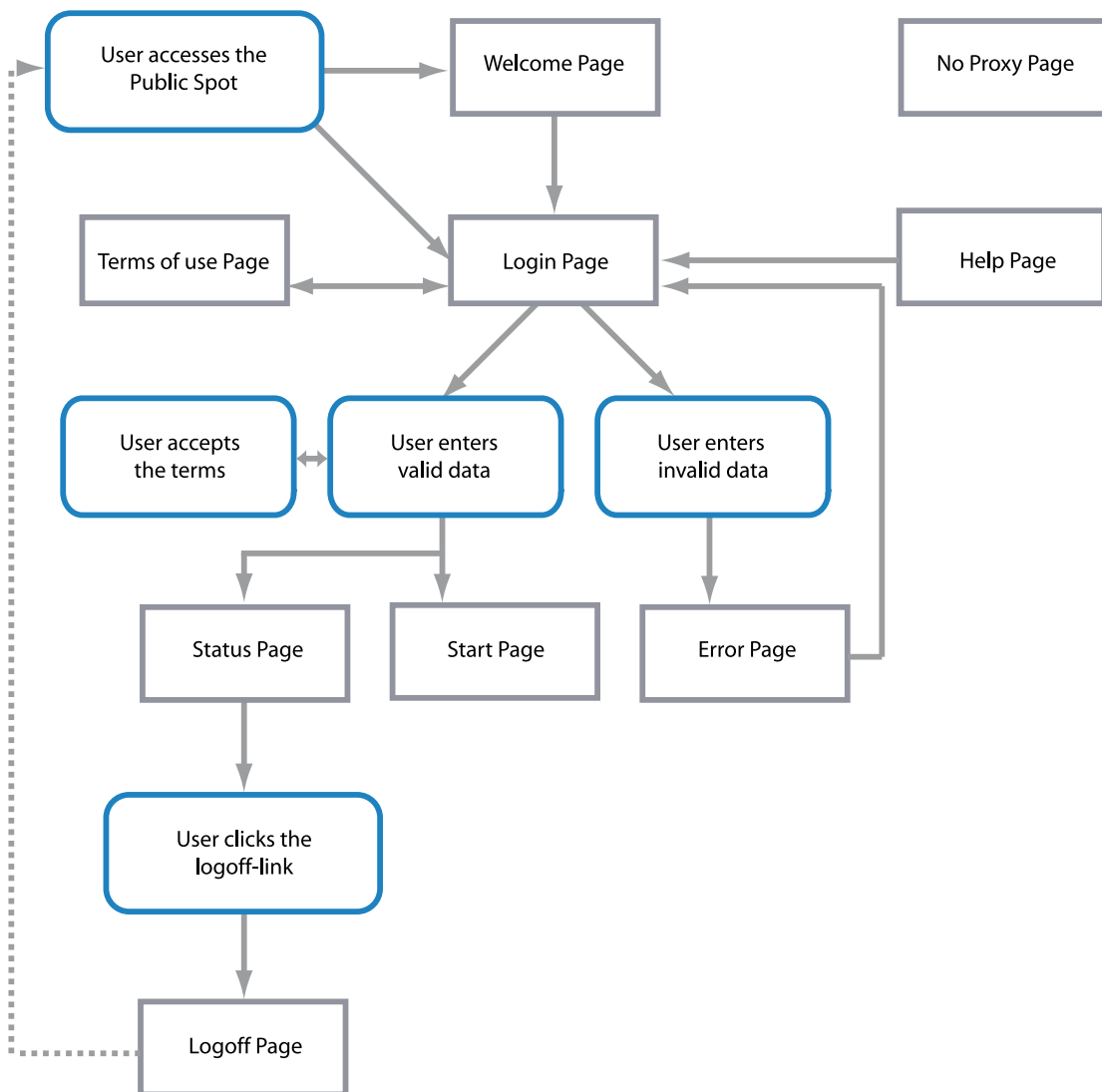

### Possible pages

The **Welcome** and **Login** pages are displayed to users when they access the Internet or the Public Spot for the first time. The welcome page has a higher priority than the login page and is often used for cosmetic reasons only: Some hotspot providers like to welcome their users on a separate welcome page in order to present, for example, information about local offers or instructions for registration, while others prefer to provide the fastest possible access to the Internet. Alternatively, some providers use the welcome page to display customized terms of use, which users have to accept

before they can go to the start page with the login form (e.g., "Login with name and password") or access the Internet ("Login after agreement").

This has nothing to do with the **Terms of use** page. This is displayed on the login page as an additional link if you selected login via e-mail or SMS, and if you also require confirmation of the terms of use.

 The pre-installed default pages on your device do not include a welcome page or the terms of use. If you invoke one of these pages without loading the corresponding template onto your device, your users will automatically be redirected to the login page (missing welcome page) or an error message will be displayed (missing terms of use).

After the user has logged in with his login data, the device checks that the information is correct and displays either an **Error** page, which sends the users back to the login page, or shows the **Start** page. This page verifies the successful login and redirects the user after a few seconds to the Internet page that the user originally requested. Additionally, a small popup window is opened that holds the **Status** page. This page shows the user the current information about his session (e.g., time used so far, sent/received data volumes, and validity period for his account). It also offers a link to close the session and stop accounting. If a user clicks on this link, the user is sent to the **Logoff** page, which confirms the successful logout from the Public Spot.

The remaining **Help** and **No-proxy** pages are isolated pages not related to the remaining login process.

- The **No-proxy** page is displayed whenever a user tries to connect via HTTP on port 8080 instead of port 80. This port is typically used in Intranets for an HTTP proxy. Since this proxy is configured with a static IP address in the browser settings, but these can not be configured via DHCP, the user would not be able to reach this proxy in any case. The purpose of this page is just to instruct the user to disable the proxy before the user can proceed.
- The **Help** page is only a placeholder in order to represent specific information (e.g., details about the login or where to get vouchers). The set of default pages built into the device does not contain a help page.

The **Voucher** page is not one of the authentication pages: This is the graphic template for printing the vouchers. By uploading your own template, you can print tickets with the corporate design of your own company.

## Pre-installed default pages

As mentioned previously, your device contains a set of pre-installed pages on delivery, which you can use to setup an operational Public Spot. There are pages for

- HTTP redirection,
- Login/logout function,
- Status Information.

They were deliberately designed to be simple, not to use any fancy features like dynamic HTML, and just present the necessary elements as-is. By only using the absolutely necessary elements, the correct display in any browser and any size of screen can be assured.

As the operator of a hotspot you may want to design more sophisticated pages or display a more neutral page without the manufacturer's logo. For that reason, the Public Spot module offers you the possibility to replace all or some of the default pages with your own design. This can be done either by using HTTP redirection or templates that you upload to the device and that the device processes like an intelligent HTML pre-processor. The templates can be directly loaded in the flash storage, which makes it possible to dispense with an external HTTP server (see chapter [User-defined pages via HTTP redirect](#)).

## Customizing the standard pages

As an alternative to installing complete user-defined Web pages, the device provides the option of customizing the pre-installed default pages to a certain extent. This includes for example the input of a login text that is displayed to your users in the registration form, or replacing the header image (logo). In this way, you can quickly deploy a customized Public Spot without having to deal in-depth with the subject of the Web page authoring.

## Customized text on the login page

The Public Spot module gives you the option to specify customized text, which appears on the login page inside the box of the registration form. Do this by executing the following steps.

1. In LANconfig, open the configuration dialog for the device.
2. Navigate to the dialog **Public Spot > Authentication** and enter the text that you want your Public Spot users to see in the **Customization** section. You can enter an HTML string with max. 254 characters composed of:

```
[Space][0-9][A-Z[a-z]@[|}]~!$%&'()+-./:;<=>?[\]^_.#*
```

LANconfig automatically transforms umlauts. To enter umlauts, you must use their HTML equivalents (e.g. &uuml; for ü). You can also use HTML tags to structure and format the text. Example:

```
Herzlich Willkommen!
<i>Bitte füllen Sie das Formular aus.</i>
```

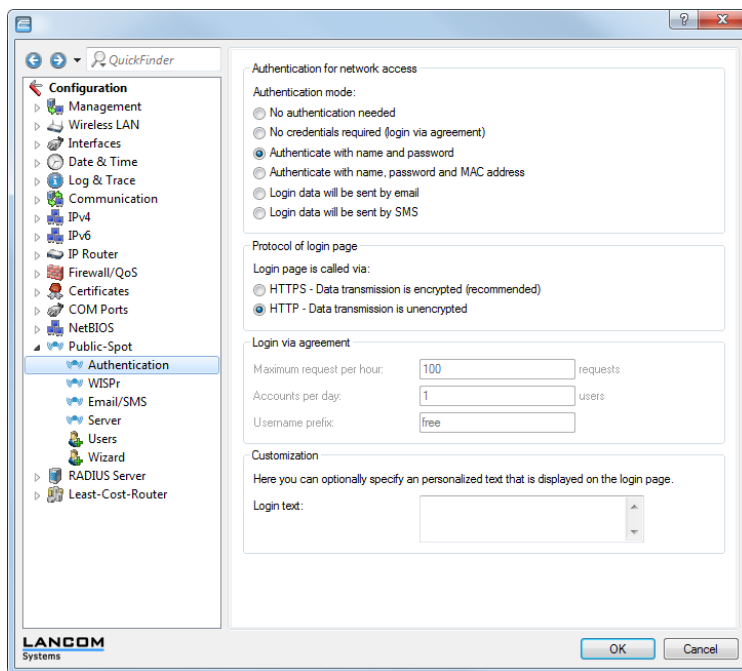

3. Click on **OK** to load the login text into the device.

Once the configuration has been written successfully, the new login text appears the next time the Public Spot page is called.

## Custom header images for variable screen widths

A component of the pre-installed pages in the device is a header image (logo), which is displayed to your users above the login form for the Public Spot. You can change this header image as you please, for example to reflect the application environment or your corporate design. There is no need for an external Web server; you can simply upload the image directly into the device via the file management in WEBconfig or the configuration management in LANconfig.

A special feature of the header image is that it is available in the device as two possible variants: One version is for large screens or browser windows with a horizontal resolution exceeding 800 px (normal monitors, laptops, tablet PCs, etc.),

and one is a small picture for screens with a lower horizontal resolution (PDAs, mobile phones, etc.). This allows you to provide header images for different target groups and to provide them a login page that is appropriate for their device.



Login



Show password

Powered by  
**LANCOM**  
Systems

**Figure 4: Login page for large screens**

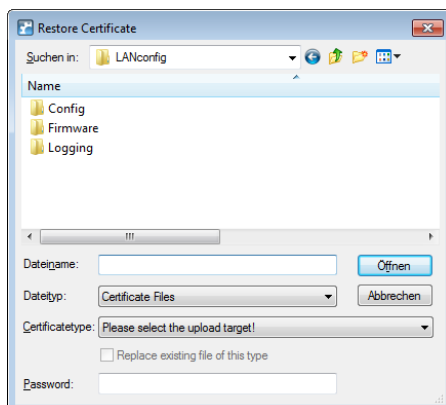

**Figure 5: Login page for small screens**

The available resolutions are set by the CSS file of the device. The pre-installed default graphics allow for 800x150 px for the large screen and 258x52 px for the small screen. The file type must be either JPG, GIF, or PNG.

To upload a new header image to the device either as a large or small version, follow the steps below.

1. Start LANconfig and highlight the device.
2. In the menu bar, click on **Device > Configuration management > Upload certificate or file**. The **Upload certificate** dialog opens.



3. Set the **File type** to **All files** and select the **Certificate type** that you want to upload.
  - **Public Spot - Header image of pages:** Certificate type for large screens
  - **Public Spot - Header image box:** Certificate type for small screens

4. Choose your custom header image and click on Open. LANconfig then starts the file upload.

After uploading successfully, the new header image appears the next time the Public Spot page is called.

- ! You can check that the large and small header images are displayed by your Public Spot by setting your browser window width to >800 px and then reducing the width of the window. The CSS technology automatically switches between the large and small pictures.

## Configuration of user-defined pages

If you would like to replace the pre-installed pages with your own webpages, you can either store them directly on the device or on an external HTTP server. Sophisticated HTML pages may require more storage space than the space available on the device. There are additional advantages when using websites from an external server:

- Changes can be applied centrally. This reduces the effort required to change the login pages when using several devices.
- The server can dynamically provide the pages whose appearance is influenced by the information that the device provides. This information is discussed in more detail in the following chapters.

The storage location for the templates is entered in LANconfig in **Public Spot > Server > Page table > <Name of the template> > Page address (URL)**. There are currently three protocols available for the URL:

- `http://...:` Fetch the page via HTTP from an external server. TCP-port overrides and user/password specifications are possible.
- `https://...:` Similar to HTTP, but use HTTP over SSL for an encrypted connection.
- `file://...:` Retrieve the template from the given file in the device's local file system.

You can use any file. Some file names are reserved for this purpose:

**Table 9: Overview of the reserved file names for template pages**

Local URL on your device	Page designation
<code>file://pbspot_template_welcome</code>	Welcome...
<code>file://pbspot_template_login</code>	Login...
<code>file://pbspot_template_error</code>	Error...
<code>file://pbspot_template_start</code>	Start...
<code>file://pbspot_template_status</code>	Status...
<code>file://pbspot_template_logoff</code>	Logoff...
<code>file://pbspot_template_help</code>	Help...
<code>file://pbspot_template_noproxy</code>	No proxy
<code>file://pbspot_template_voucher</code>	Voucher...*
<code>file://pbspot_template_agb</code>	Terms of use...

\*Template for printing vouchers, no authentication page

- ! By uploading user-defined webpages, only the webpages that are pre-installed on the device are replaced, but not overwritten. They can be rolled back to the device's proprietary default pages at any time by deleting the local URL.

- ! To provide the highest possible compatibility with earlier display devices and web browsers, you should avoid using frames, if possible. Also, specialized content such as JavaScript or plug-in elements can lead to an erroneous display.

## URL placeholder (template variables)

The URLs specified in the page table do not need to be absolute strings. You have the option to integrate template variables in the address which are then filled-out with parameters from a Public Spot session when the device requests the pages from the server. Placeholders have a form similar to C format strings, e.g., a percent sign immediately followed by a single, lowercase character. The following placeholders are defined:

**%a**

Inserts the device's IP address. The placeholder only returns a value if the **Request type** in the **Page table** is set to `Template`.



Note that this placeholder cannot generate a reachable address if the device itself is located behind another router with activated NAT.

**%e**

Inserts the device serial number.

**%i**

Inserts the NAS port ID. In this context, "NAS" stands for "Network Access Server". This variable contains the interface of the device that the client used to login. For a WLC or router without WLAN this corresponds to a physical interface, such as `LAN-1`, or, for a standalone access point, it is the SSID.

**%l**

Inserts the device host name.

**%m**

Inserts the MAC address of the client as a hexadecimal string of length 12. The individual bytes are separated by colons.

**%n**

Inserts the name of the device the way it is configured in the setup menu under **Name**.

**%o**

Inserts the URL of the Internet page which the user initially requested. After successful authentication, the device forwards the user to this URL.

**%s**

If the client is connected to the device via a WLAN interface, this placeholder will insert the WLAN SSID used in the network that the client is connected to. This feature is particularly interesting when MultiSSID is used, since this gives the server the opportunity to display different pages based on the SSID. If the client is connected via another access point that connects to the device via a Point-2-Point connection, the SSID of the first WLAN will be inserted. If the client is connect via Ethernet, the placeholder remains empty.

**%t**

Inserts the routing tag which is appended to the client's data packets.

**%v**

If the requesting client is assigned an individual VLAN ID, this variable contains the source VLAN ID.

**%0-9**

Inserts a single number between 0 and 9.

**%%**

Inserts a single percent character.

In order to be able to use variables for a template, add the parameters to the **Page Address (URL)** in the page table. In the following URLs the variable `%i` is replaced with `LAN-1` as described in the sample above:

**Example:** `http://192.168.1.1/welcome.php?nas=%i`

**Example:** `http://192.168.1.1/%i_welcome.html`



## User-defined pages via HTTP redirect

If you implement user-defined pages with redirection (request type: redirect), your device transforms it as follows: Whenever your device must send the respective page to a client, it will expand the URL according to the rules given in the previous chapter and will send an HTTP 307 (temporary redirect) response to the device, with this URL as the new location.

Redirects are particularly meaningful if you use a welcome page and all authentications should be performed on one external gateway. In this case, the clients can be immediately redirected to this gateway. This feature is often used with the external device controller.

## User-defined pages via page templates

The device can alternatively act as a client and use the extended URL to download a user-defined page via an HTTP connection. The internal pre-processor takes care of the processing of the page and subsequently sends the result to the Public Spot user. This pre-processor makes it possible to process session-specific data, although the server has a static page available. The URL syntax understood by the device's built-in HTTP client is the syntax recognized by web browsers. However, only a subset of what is recognized by browsers is supported:

- The user authentication is performed using the form `user:password@host/...`
- The device is incapable of automatically resolving non-fatal HTTP errors such as redirects. Make sure that an access to this page will return the page directly.

Usage of symbolic names for the server's host instead of plain IP addresses is supported, given that DNS is properly configured. In many aspects, this mechanism can be considered like a proxy, which fetches HTML pages and then sends them to the client. The biggest difference is that the URL of the pages is determined by the device and not by the client of the Public Spot user.

## Auto-fallback

For every entry in the page table, it is possible to individually define whether a fallback should be used or not. This fallback feature is only meaningful if a page is defined as a template (request type: template), and not as a redirect (request type: redirect). While fetching a page via HTTP, various errors can appear:

- The DNS lookup for a host name may fail.
- The TCP/HTTP connection to the server may fail.
- The HTTP server may respond with an error code (e.g. 404 if an invalid URL was given).

By default, the device passes this type of error on to the user so that the user can start a new request or inform the provider of the Public Spot. Alternatively, the configuration of a fallback feature can ensure that the hotspot continues to function by using the default pages instead. You enable the fallback feature in LANconfig using the setting **Fallback to implemented page**.

## Passed HTTP attributes

As mentioned above, in some respects the device may be seen as an HTTP proxy that fetches login and status pages for the client. HTTP proxies are obliged to keep certain HTTP attributes intact while forwarding a client request:

- The device forwards cookies between the client and the server. Client cookie values can also be sent transparently to the server and the server can set cookies on the client. Using cookies is necessary if the files that are sent from the server have ASP scripts, since ASP stores the session ID in a cookie.
- The device will forward the `User-Agent` value provided by the client. This allows a server to deliver different pages, based on the browser and system platform on the client side. PDAs and mobile phones for example call for web pages optimised for their small displays.
- The device inserts an `X-Forwarded-For` line into the HTTP request to report the device's IP address.
- WEBconfig generally attempts to use a tag named `Accept-Languages` provided by client browsers to match the request to one of the languages provided by its internal message tables (currently, only German and English). The selected language is communicated to the server via another `Accept-Languages` tag, in the hope that the server will provide a page in the appropriate language. When the server delivers the page, the device will check

for a Language tag in the server's response to see if the server was actually capable of delivering a page in the requested language. If not, it will adapt the strings used in template expansion (see next section) to the actual language of the page.

## Page template syntax

After the device receives the page from the server, it performs some transformations to the page template before sending it to the client. These transformations replace pre-defined HTML tag placeholders with data belonging to the client's current session (e.g. the current resource consumption in the status page). An HTML page delivered by the server could therefore better be described as a template for an actual HTML page displayed in the client's browser. HTML syntax was chosen for the placeholders to allow editing of page templates without interfering with syntax sensitive HTML editors.

A set of sample page templates is available from LANCOM Systems. They are not meant to be used in productive systems, but instead to illustrate the use of page templates, and provide a starting point for your own creations. In total, three placeholder tags are defined:

- `<pblink identifier>text </pblink>`

Marks **text** as a clickable link to an **identifier**, typically to link to another page. Note that `</pblink>` is just an alias for `</a>`, since this symmetrical definition causes less trouble with HTML syntax checkers. For example, the following fragment defines a link to the help page:

```
Please click <pblink helplink>here</pblink>for help.
```

- `<pbelem identifier>`

Insert the item specified by **identifier** at this place. For example, the following line inserts the user's time credit:

```
Session will be ended in <pbelem sesstimeout>.
```

- `<pbcond identifier(s)>code</pbcond>`

Only insert **code** into the page if all the identifiers are TRUE, i.e. numeric values are not equal to zero and string values are not empty. Note that the current implementation does not allow nested conditionals. Continuing from the previous example, the session timeout is only displayed if there is a time limit (a session without timeout internally has a session timeout of zero):

```
<pbcond sesstimeout>Session will be terminated in <pbelem sesstimeout>seconds.</pbcond>
```

## Page template identifiers

The following identifiers are currently defined.

 Please note that not all identifiers are available for all printouts! Not all identifiers are available on all pages.

### APADDR

**Valid for:** `<pbelem>`

This identifier contains the Public Spot's IP address, as seen from the client's perspective. Can be used for user-defined login forms when the LOGINFORM element is not used.

### HELPLINK

**Valid for:** `<pbelem>`

This identifier contains the URL to the help page provided by the device.

### LOGINERRORMSG

**Valid for:** `<pbelem>`

This identifier returns the error message from LCOS in the case of a failed authentication. It is only valid when used on the error page.

---

 To retrieve the error message from the RADIUS server in the event of a failed authentication, use the identifier **SERVERMSG**.

**LOGINFORM**

**Valid for:** <pbelem>

This identifier refers to the HTML form for entering the user's name and password.

**LOGINLINK**

**Valid for:** <pbelem>

This identifier contains the URL to the login page provided by the device.

**LOGOFFLINK**

**Valid for:** <pbelem>

This identifier contains the URL to the logout page provided by the device.

**ORIGLINK**

**Valid for:** <pbelem><pblink><pbcond>

This identifier contains the URL originally requested by the user prior to the authentication process. If it is unknown, this value is empty.

**REDIRURL**

**Valid for:** <pbelem><pblink><pbcond>

This identifier holds a possible redirection URL contained in the RADIUS server's authentication response (if there was one). It is only defined for the error and start page.

**RXBYTES**

**Valid for:** <pbelem>

This identifier contains the amount of data so far received by the device from the client in this session, expressed in bytes. It is zero for a station that is not logged in.

**RXTXBYTES**

**Valid for:** <pbelem>

This identifier contains the amount of data received by the device from the client so far, or sent to the client in this session, expressed in bytes. This means that it is the sum of TXBYTES and RXBYTES.

**SERVERMSG**

**Valid for:** <pbelem><pbcond>

This identifier holds the reply message contained in the RADIUS server's authentication response (if there was one). Only applicable for the error and start pages. In the case of a failed authentication, this identifier contains the error message from the RADIUS server.

---

 To retrieve the error message from the LCOS server in the event of a failed authentication, use the identifier **LOGINERRORMSG**.

**SESSIONSTATUS**

**Valid for:** <pbelem>

This identifier contains a textual representation of the current status of the client relative to the device (whether authenticated or not).

**SESSIONTIME**

**Valid for:** <pbelem>

This identifier contains the time that has passed since the login on the Public Spot.

**SESSTIMEOUT**

**Valid for:** <pbelem><pbcond>

This identifier contains the remaining time for the current session. After this time, the device ends the current session automatically. This identifier is zero for a session with no time limit.

**STATUSLINK**

**Valid for:** <pbelem><pbcond>

This identifier contains the URL to the logout page provided by the device. A reference that opens a new browser window is automatically generated within the <pblink> element.

**TXBYTES**

**Valid for:** <pbelem>

This identifier contains the amount of data transmitted by the device to the client so far in this session.

**USERID**

**Valid for:** <pbelem>

This identifier contains the user ID with which the current session was started. The identifier is not specified if the client is not (yet) logged in.

**VOLLIMIT**

**Valid for:** <pbelem><pbcond>

This identifier contains the amount of data, expressed in bytes, that the client is still allowed to transfer before the device terminates the current session. This identifier is zero for a session with no data limit.

**Graphics in user-defined pages**

All but the simplest web pages contain images, which are fetched by the client's browser independent of the HTML page itself. The graphic files for the pre-installed page are also stored on the device. The device automatically adapts the necessary permissions so that even unauthorized clients have access to the images without problems. However, every access to the referenced (device-external) images for user-defined pages are treated like a normal Internet access, and would automatically send the user back to the welcome or start page.

In order to avoid this behavior, you should make sure that the servers where the graphics are stored are included in the **free servers**. Free servers are addresses that have unlimited access, and are therefore also accessible by unauthenticated clients, and are not billed by the accounting feature in the same way as the rest of the data traffic.

The chapter [Login-free servers and networks](#) contains additional information about configuring free servers. Note that if a user-defined page is defined as a redirect, this of course has to be defined as a free IP address.

## 14.3 Access to the Public Spot

### 14.3.1 Requirements for logging in

- Device with network adapter
- Operating systems supporting the TCP/IP protocol (automatic IP-address retrieval by DHCP active)
- Web browser (supporting JavaScript and Frames)
- Direct Internet access (use of proxy deactivated)
- WLAN access information (network name, encryption information)
- Valid user data (user identifier and password)

### Information for WLAN access

A maximum of two pieces of information are required to access the WLAN:

- **The network name of the WLAN (SSID)**

If the Public Spot's base stations are configured for operation as a closed network, the user must know the exact name of the wireless LAN, its SSID.

- **Wireless LAN encryption**

Although it is possible to provide guest access via encrypted connections using, for example, WPA, Public Spots are not generally operated with WLAN encryption. Protection is provided in this case using authentication with a username and password. Data security when transmitting data on the Public Spot must be provided by the end user (e.g., using a VPN client).

### Information for LAN access

If the IP addresses on your network are automatically assigned (for example, via DHCP), your users only need:

- a LAN socket that connects to the Public Spot.
- a LAN cable to connect their LAN adapter to the LAN socket.

### Information for authentication

The user needs to have the following information to hand when logging in:

- User identifier
- Password
- MAC address

If you set the authentication mode for a Public Spot at the base station to "MAC+User+Password", you, as the operator, must know the MAC addresses of the end devices employed by your users. An end device automatically and continuously transmits its MAC address when communicating with a base station. The user does not have to manually enter this information when logging in, but instead it is communicated just once to the operator before attempting to login.

## 14.3.2 Logging in to the Public Spot

1. Log in to the WLAN of the Public Spot (for WLAN connections) or connect to the network using an Ethernet cable (for LAN connections).

The different types of mobile devices and WLAN adapters offer various ways of entering the settings required for accessing the WLAN. Many devices require the network name (SSID) of the WLAN to be entered into the configuration program for the WLAN adapter. Some other products also provide an overview of all base stations in the vicinity, from which the user simply chooses the one they want to use.

Depending on the configuration, the user receives the necessary settings for the LAN-adapter connection either automatically from the network or a connected DHCP server, or from the network administrator.
2. Start your Web browser.

## 14 Public Spot

As soon as the Web browser attempts to access any Internet site, the Public Spot automatically intervenes and presents the login page.



**Login**

Your user-id

Your password

Show password

Powered by  
**LANCOM**  
Systems

⚠ Depending on the firmware version, the actual login page may vary from the one shown here. However it looks, the login page will always present the input fields for user ID and password.

- Enter the complete **user ID** and **password** in the corresponding fields and confirm your entries with **Login**.

⚠ To login, you should use a Web browser with JavaScript support enabled to ensure that session status information can be displayed in a popup window.

If the login to the Public Spot is successful, an additional window pops up with the main information about the current session. This window is also used for the login. This window should be left open throughout the session (e.g., it can be minimized).

### 14.3.3 Session information

The window with session information is automatically updated at regular intervals. Along with the status and current user ID, the information displayed includes the connection time and the volume of transferred data.

If the session-information window is not open, you can open it by entering the following in the address line in the browser:

`http://<IP address of the Public Spot>/authen/status/`

**Session information**

Status:	logged in
User ID:	491
Login Time:	17m:43s
Account expires in:	42m:20s
Transmitted data:	39 KBytes
Received data:	187 KBytes
Transfer volume:	unlimited

Click [here](#) to log out.

Powered by  
**LANCOM**  
Systems

### 14.3.4 Logging out of the Public Spot

The session information window can be used to logout from the Public Spot. Simply click on the word **here** in the bottom line of text in the window.

If the session-information window is not open, you can enter the following into the address line in the browser:

`http://<IP address of the Public Spot>/authen/logout`

The Public Spot operator can supply you with the <Public Spot 's IP address> upon request.

- 
-  The operator can set up the Public Spot to automatically logoff users if they cannot be reached for 60 seconds. In case of doubt, please ask the Public Spot operator if automatic logoff (Station monitoring) is activated.

### 14.3.5 Advice and help

The following sections present solutions to the most common problems that may occur when operating a Public Spot.

#### The Public Spot login page is not displayed

- The Internet access must be set up so that it is directed via the network adapter and not via a dial-up networking connection. To check this, take a look at the connection settings for your Web browser. If you use Microsoft Internet Explorer, you must disable the dial-up configurations in **Tools > Internet Options > Connections** entered there.
- Internet access must be direct, i.e. without going via a proxy server. In Microsoft Internet Explorer, you can disable the use of a proxy server in the menu **Tools > Internet Options > Connections > LAN-Settings...**
- If you are making the connection with a WLAN adapter: Ensure that your network adapter can in fact find the Public Spot. Your WLAN adapter gives you the option of searching for an access point.
- If you are making the connection with a WLAN adapter: Check if your network adapter has all of the necessary settings to access the Public Spot network:
  - You probably have to enter the network name for the WLAN.
  - When working with an encrypted Public Spots, you are also required to enter the corresponding WPA or WEP key.
- Check that your network adapter is set up for automatic retrieval of an IP address (DHCP). Your device should not have a fixed IP address.

- 
-  If your network adapter is set up with a fixed IP address, adjusting it for automatic retrieval by DHCP may cause important configuration information to be lost. Ensure that you note all of the values listed in the network settings (IP address, standard gateway, DNS server, etc.).

#### Login not working

- Ensure that you enter the user data correctly and in full. Ensure that you use the correct capitalization for all entries.
- Is the CAPS-LOCK key activated on your device? This causes the capitalization to be reversed. Deactivate the CAPS-LOCK key and repeat the entry of your login data.
- The Public Spot operator may be checking more than just the user ID and password, but also the MAC address (physical address) of your network adapter as well. In this case, ensure that the Public Spot operator is informed of your correct MAC address.

#### It is no longer possible to login

If the Public Spot breaks off communications after a number of login attempts have failed, you should deactivate your WLAN adapter for at least 60 seconds (or your entire device) or disconnect the LAN adapter from the network, and then try again.

#### The session information window is not being displayed

To display the session-information window, enter the following line into the address line of your Web browser:

```
http://<IP address of the Public Spot>/authen/status
```

The Public Spot operator can supply you with the <Public Spot's IP address> upon request.

#### The Public Spot requests a new login for no reason (WLAN)

When moving into the signal coverage area of another access point (roaming), it is necessary to login again. If you are located in the overlap area between two access points, you may even experience a change of connection between the

two access points at regular intervals. The task of the roaming secret is to allow Public Spot sessions to be passed between access points without the user having to login again.

- LANconfig: **Public Spot > Users > Roaming Secret**

## 14.4 Tutorials for setting up and using Public Spots

The following tutorials describe examples of how the Public Spot option can be implemented.

### 14.4.1 Virtualization and guest access via WLAN controller with VLAN

Many companies wish to offer Internet access to their visitors via WLAN. In larger installations the required settings apply to multiple access points, and these can be programmed centrally in the WLAN controller.

#### Objectives

- Wireless LAN infrastructure available to internal employees and guests
- Shared physical components (cables, switches, access points)
- Separation of networks with VLAN and ARF
- Break-out of data streams to certain target networks:
  - Guests: Internet only
  - Internal employees: Internet, all local devices and services
- Guests login to the WLAN with a Web form.
- Internal employees use WLAN encryption for authentication.

#### Establish

- Management of the access points is handled by the LANCOM WLC.
- The LANCOM WLC serves as the DHCP server for the WLAN clients in the guest network.
- The guest network is provided with Internet access via the LANCOM WLC (e.g. separate DSL access or Internet access via the company DMZ).
- The wired infrastructure is based on managed VLAN-capable switches:
  - The VLAN management of access points is handled by the LANCOM WLC.
  - The VLAN management of the switches is handled separately by the switch configuration.
- The access points operate within the internal VLANs.

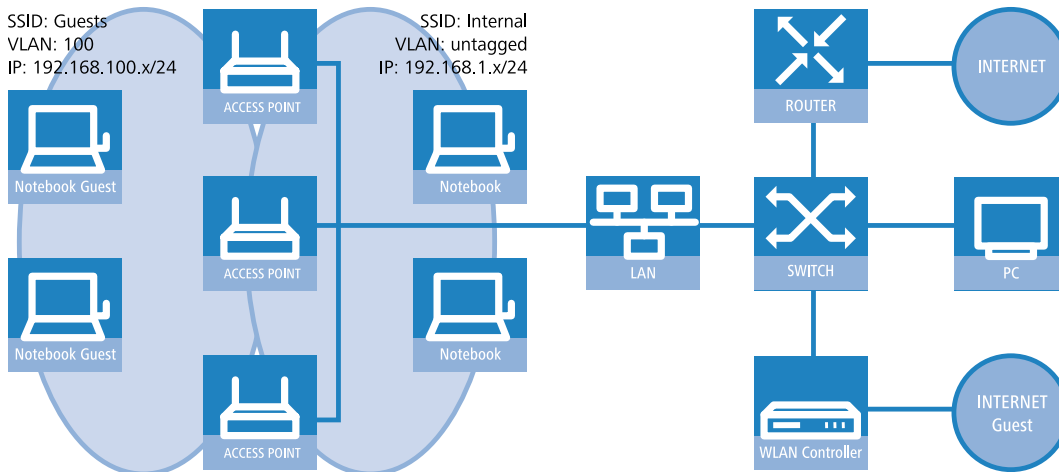



## Wireless LAN configuration of the WLAN controllers

During the configuration of the WLAN, the necessary WLAN networks are defined and, along with the physical WLAN settings, are assigned to the access points managed by the controller.

1. Create a logical WLAN for guests and one for the internal employees:

- The WLAN with the SSID `GUESTS` uses the VLAN ID `100` (VLAN operating mode **Tagged**) and uses **no** encryption.
- The WLAN with the SSID `INTERNAL` receives no VLAN ID (VLAN operating mode **untagged**, i.e. packets are transferred in the Ethernet without a VLAN tag) and uses WPA encryption, e.g. **802 11i (WPA)-PSK**.
- LANconfig: **WLAN Controller > Profiles > Logical WLAN networks (SSIDs)**

Logical WLAN networks (SSIDs) - New Entry

Logical WLAN network activated

Name: GUESTS

Inheritance

Inherit from entry:  Select

Inherited values

Network name (SSID): GUESTS

Connect SSID to: LAN at AP

VLAN mode: Tagged

VLAN ID: 2

Encryption: None

Key 1/passphrase:  Show

Generate password

RADIUS profile: DEFAULT Select

Allowed frequency bands: 2.4/5 GHz (802.11a)

AP standalone time: 0 minutes

MAC check activated

Suppress SSID broadcast: No

RADIUS accounting activated

Allow data traffic between stations of this SSID

WPA version: WPA1/2

WPA1 session key type: TKIP

WPA2 session key type: AES

Basis rate: 2 Mbit/s

Client Bridge Support: No

Maximum count of clients: 0

Min. client signal strength: 0 %

Use long preamble for 802.11b

802.11n

Max. spatial streams: Auto

Allow short guard interval

Use frame aggregation

STBC (Space Time Block Coding) activated

LDPC (Low Density Parity Check) activated

OK Cancel

Logical WLAN networks (SSIDs) - New Entry

Logical WLAN network activated

Name: INTERNAL

Inheritance

Inherit from entry:  Select

Inherited values

Network name (SSID): INTERNAL

Connect SSID to: LAN at AP

VLAN mode: Untagged

VLAN ID: 2

Encryption: None

Key 1/passphrase:  Show

Generate password

RADIUS profile: DEFAULT Select

Allowed frequency bands: 2.4/5 GHz (802.11a)

AP standalone time: 0 minutes

MAC check activated

Suppress SSID broadcast: No

RADIUS accounting activated

Allow data traffic between stations of this SSID

WPA version: WPA1/2

WPA1 session key type: TKIP

WPA2 session key type: AES

Basis rate: 2 Mbit/s

Client Bridge Support: No

Maximum count of clients: 0

Min. client signal strength: 0 %

Use long preamble for 802.11b

802.11n

Max. spatial streams: Auto

Allow short guard interval

Use frame aggregation

STBC (Space Time Block Coding) activated

LDPC (Low Density Parity Check) activated

OK Cancel

! If you set the **VLAN mode** to **untagged**, LANconfig will gray-out the **VLAN ID** input field in the add/edit dialog shown above. However, the corresponding table **Logical WLAN networks (SSIDs)** still displays the assigned VLAN as a value in the grayed-out box. This entry is only of internal significance, as the acceptable range is between 2 and 4094. Ultimately it is the VLAN operating mode which is decisive: If this is set to **untagged**, then a VLAN ID is not transmitted under any circumstances.

2. Create a set of physical parameters for the access points.

The management VLAN ID is set to 1, which serves to activate the VLAN function (but without a separate management VLAN for the device; the management data traffic is transmitted untagged).

- LANconfig: **WLAN Controller > Profiles > Physical WLAN parameters**

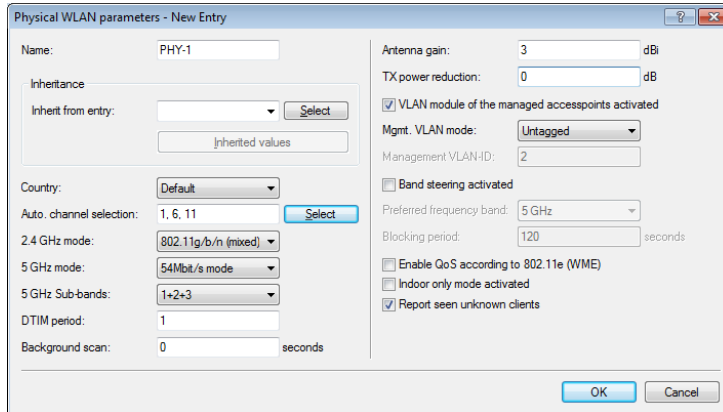

- Create a WLAN profile that you can assign to the access points. The two logical WLAN networks and the set of physical parameters defined earlier are collected into this WLAN profile.

- LANconfig: **WLAN Controller > Profiles > WLAN profiles**

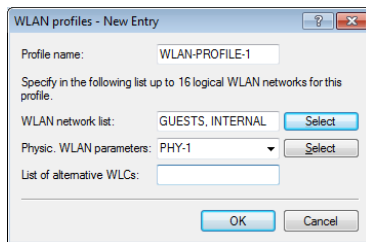

- Assign this WLAN profile to the access points managed by the controller. Do this by entering each access point with its MAC address into the access point table. Alternatively you can use the **Default** button to create a default profile, which applies to all access points.

- LANconfig: **WLAN Controller > AP Config. > Access point table**

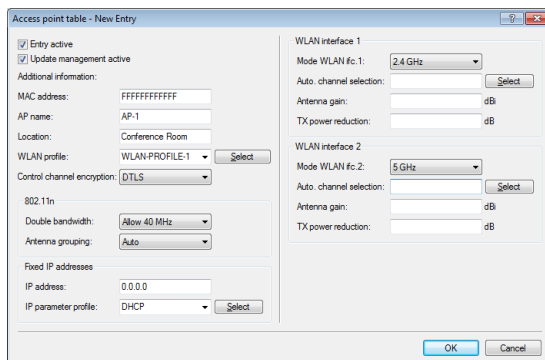

### Configuring the switch (LANCOM ES-2126+)

In this section we describe the configuration of the switch using the LANCOM ES-2126+ as an example.

1. Set the VLAN mode to **Tagged**, as the access points handle the assignment of VLAN tags.

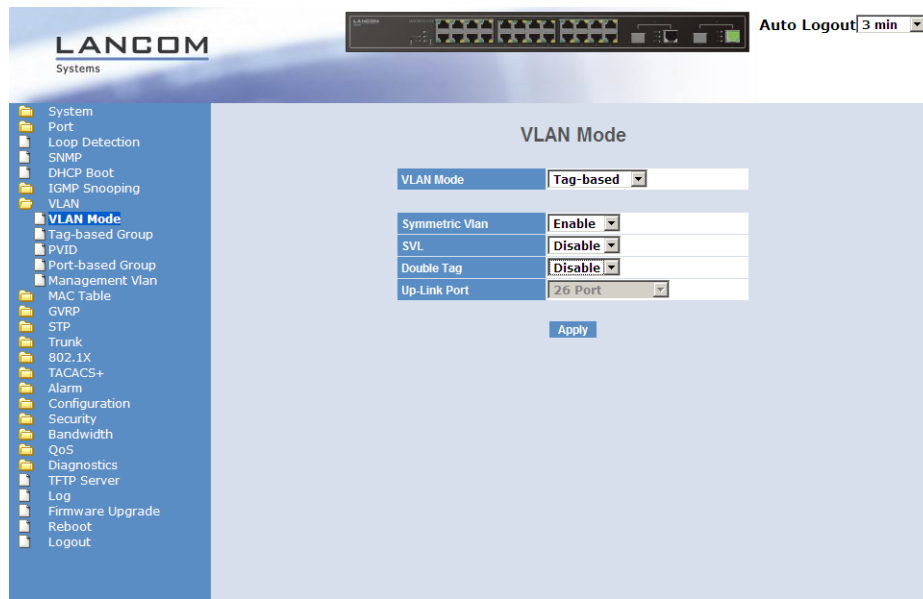

2. Set the group names of the VLANs.

To differentiate between the VLANs in the switch, two groups are used. The internal network for the employees is mapped to the default group (**default**), and a dedicated group (**guests**) is set up for the guests. The Groups use the corresponding VLAN IDs that you entered into the controller when configuring the VLANs.

The default VLAN is valid on all ports and remains untagged, i.e., the VLAN tags are removed from outgoing data packets for this group by the switch.

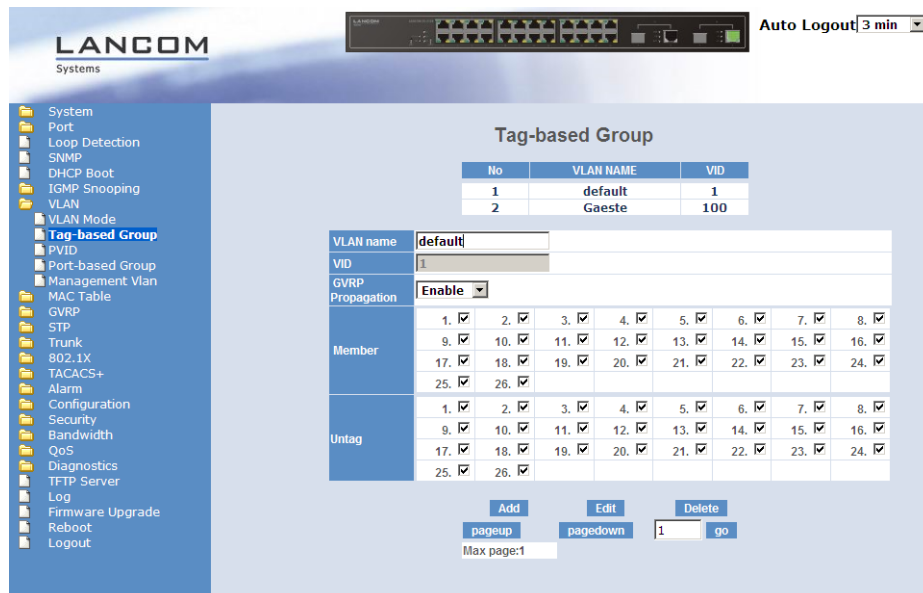

The guests' VLAN group uses the VLAN ID "100" and is valid only for the ports connected to the WLAN controller and access points (ports 10 to 16 in our example). The switch does not remove tags of outgoing data packets.

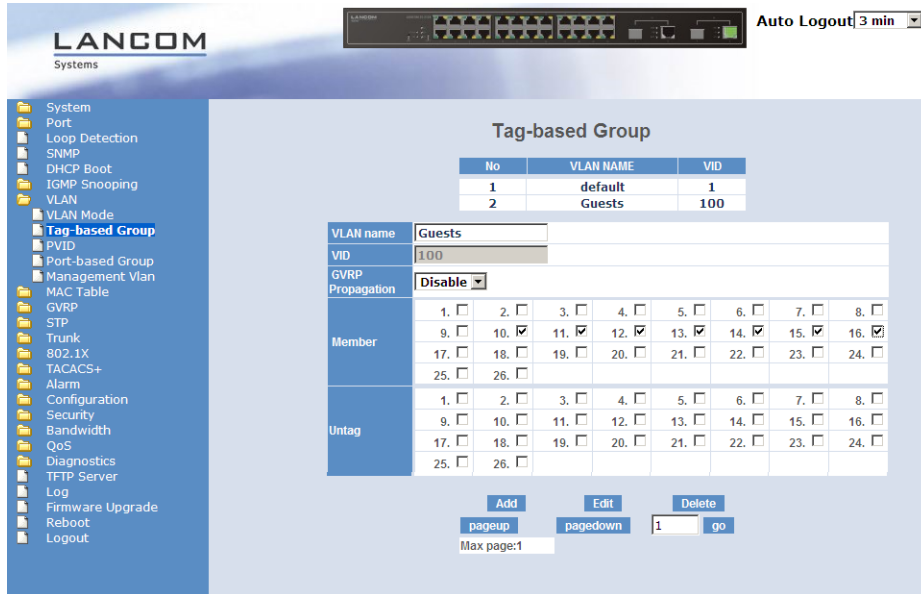

- Set the port VLAN ID (PVID) for all ports to "1".  
This assigns all ports to the internal network so that the switch assigns the VLAN ID "1" to all untagged incoming data packets on these ports before forwarding them.

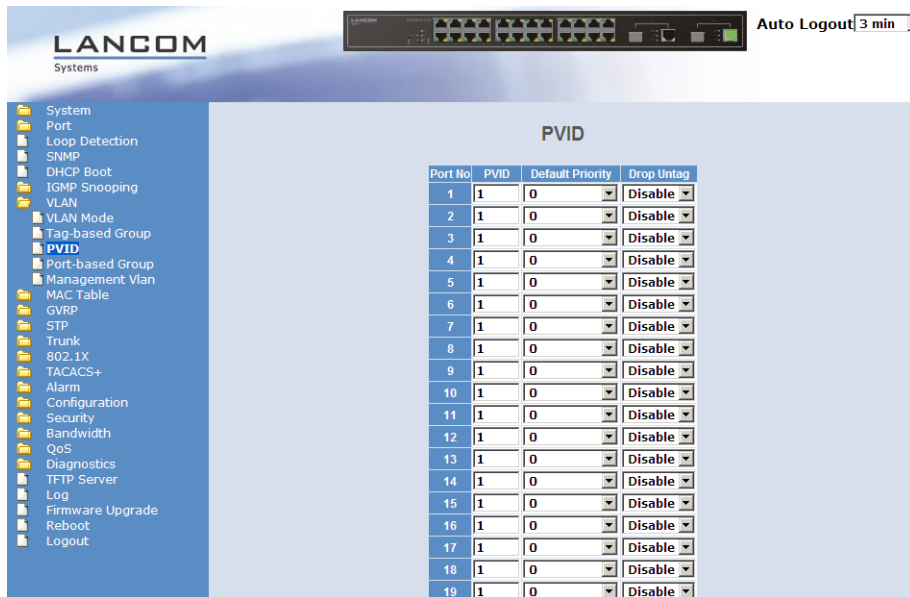

### Configuring the switch (LANCOM GS-2326P)

In this section we describe the configuration of the switch using the LANCOM GS-2326P as an example.

- Under **Configuration > VLAN > VLAN-Membership**, create an additional VLAN group for the guest network.

To differentiate between the VLANs in the switch, two groups are used. The internal network for the employees is mapped to the group `default`, and that for the guests is mapped to the group `guests`.

- The VLAN group for the internal employees uses the default VLAN ID 1. This VLAN ID used for internal administration applies on all ports and is operated untagged, i.e. all untagged incoming data packets are given

the VLAN ID 1 for internal routing, and this is removed again from outgoing data packets (see also "PVID" in the next step).

- The VLAN group for the guests uses the VLAN ID 100, which you entered earlier when configuring the WLAN in the controller. This ID applies only to the ports which the WLAN controller and the access points are connected to (in this example: Port 10 to 16, green checkmarks for **Port members**). The switch does not remove tags from outgoing data packets. i.e. all tagged incoming packets with VLAN ID 100 retain this tag and are routed only to the ports that are members of the corresponding group.

2. Under **Configuration > VLAN > Ports**, set the **Port type** for all ports to **C-port**. See the documentation about your switch for details about this setting.
3. Configure the **Egress rule** for each port.
  - All ports except port 10 to 16 are given the **Access** rule. As a result, these ports forward only tagged packets and all others are dropped.
  - The ports 10 to 16 are given the rule **Hybrid**. As a result, these ports forward both untagged and tagged packets.

⚠ Ensure that the **PVID** (port VLAN ID) for each port is set to a value of 1. The PVID is the VLAN ID that a port assigns to incoming data packets which do not already have a VLAN tag; Therefore, the PVID corresponds to the VLAN ID of the default group.

4. OPTIONAL: If you wish to allow access to the guest network via Ethernet, go to **Configuration > VLAN > Ports** and, for example, set the **PVID** to 100 for ports 17 to 20 and, under **Configuration > VLAN > VLAN-Membership**, assign these ports to the group `Guests`. All untagged incoming data packets arriving at these ports are given VLAN ID 100.

⚠ Note that these data packets can only leave the switch via the ports of the guest network.

## Configuring the IP networks in the WLAN controller

To separate the data streams on layer 3, two different IP networks are employed (ARF – Advanced Routing and Forwarding).

- For the internal network, set the **INTRANET** to the address 192.168.1.1.  
This IP network uses the **VLAN ID 0**. This assigns all untagged data packets to this network (the VLAN module in the controller itself must be activated for this). The **interface tag 1** is used for the subsequent break-out of data in the virtual router.

- LANconfig: **TCP/IP > General > IP networks**

- For guests, create a new IP network with the address 192.168.100.1.  
This network uses the **VLAN ID 100**. In this way, all data packets with this ID are assigned to the guest network. Here, too, the **interface tag 10** is used later by the virtual router.

- LANconfig: **TCP/IP > General > IP networks**

Network name	IP address	Netmask	Network type	VLAN ID	Interface	Address check	Tag	Comment
DMZ	0.0.0.0	255.255.255.0	DMZ	0	Any	Loose	0	
INTRANET	192.168.1.1	255.255.255.0	Intranet	0	Any	Loose	1	
GUESTS	192.168.100.1	255.255.255.0	Intranet	100	Any	Loose	10	

- Enable the DHCP server for both IP networks.

- LANconfig: **TCP/IP > General > IP networks**

Network name	DHCP server enabled	Broadcast	Cluster	1. server	2. server	3. server	4. server	Buf
INTRANET	Yes	No	No	0.0.0.0	0.0.0.0	0.0.0.0	0.0.0.0	No
DMZ	No	No	No	0.0.0.0	0.0.0.0	0.0.0.0	0.0.0.0	No
GUESTS	Yes	No	No	0.0.0.0	0.0.0.0	0.0.0.0	0.0.0.0	No

With these settings, the WLAN clients of the internal employees and guests are assigned to the appropriate networks.

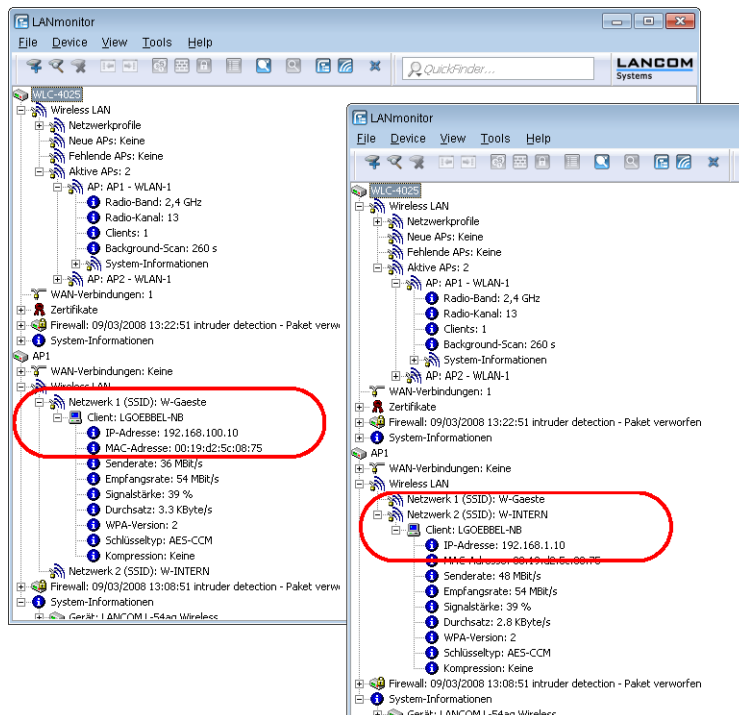

## Configuring Public Spot access accounts

The Public Spot allows you to provide a strictly controlled point of access to your wireless LAN. Authentication is performed by requesting user information via a web interface. If necessary, you can set a time limit for the access.

1. You should activate authentication for network access by name and password.

- LANconfig: **Public Spot > Authentication > Authentication for network access**

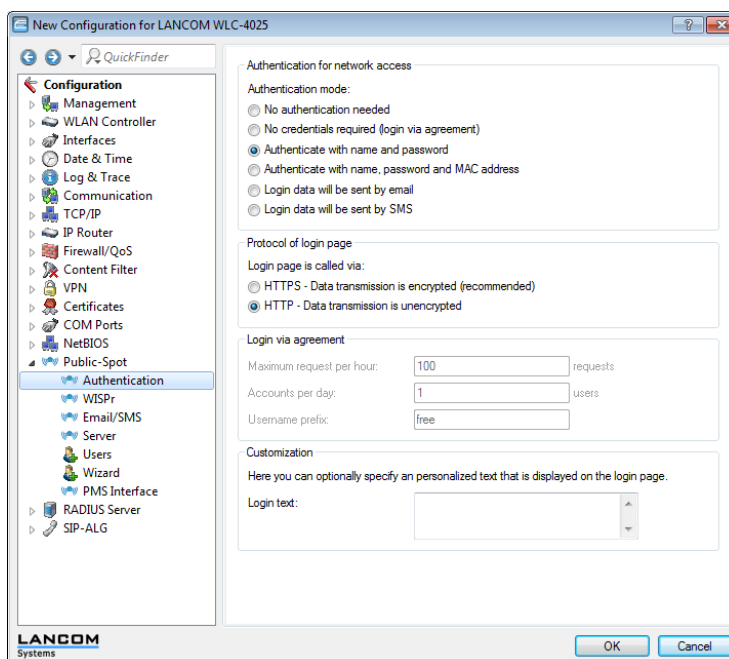

2. Activate user authentication for the controller's interface that is connected to the switch.

- LANconfig: **Public Spot > Server > Interfaces**

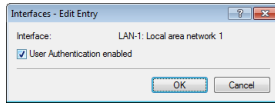

- Restrict access to the Public Spot.

You restrict use of the Public Spot to data packets from this virtual LAN by entering the VLAN ID of "100" for the guest network into VLAN table. Other data packets from other VLANs will be forwarded to the Public Spot without a login. Note that access to WEBconfig via the Public Spot interface is restricted to the authentication pages only (see [Limit configuration access](#)).

**!** If the interface is not restricted to the VLAN ID, the controller will no longer be reachable at the specified physical Ethernet port!

- LANconfig: **Public Spot > Server > VLAN table**

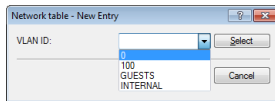

- Enable the option to clean up the user table so that your device automatically deletes entries that are no longer needed.

- LANconfig: **RADIUS server > General > Clear user lists automatically**

### Configuring the internal RADIUS server for Public Spot operation

As of LCOS version 7.70, the Wizard stores the Public Spot access accounts in the user database of the internal RADIUS server. In order to use Public Spot access accounts, you **must** configure the RADIUS server and the Public Spot module to use the RADIUS server.

- Enable the RADIUS server by entering the authentication and accounting ports so that you can use the user database on the internal RADIUS server.  
Use the **authentication port** 1,812 and the **accounting port** 1,813.



- LANconfig: **RADIUS server > General > RADIUS service**

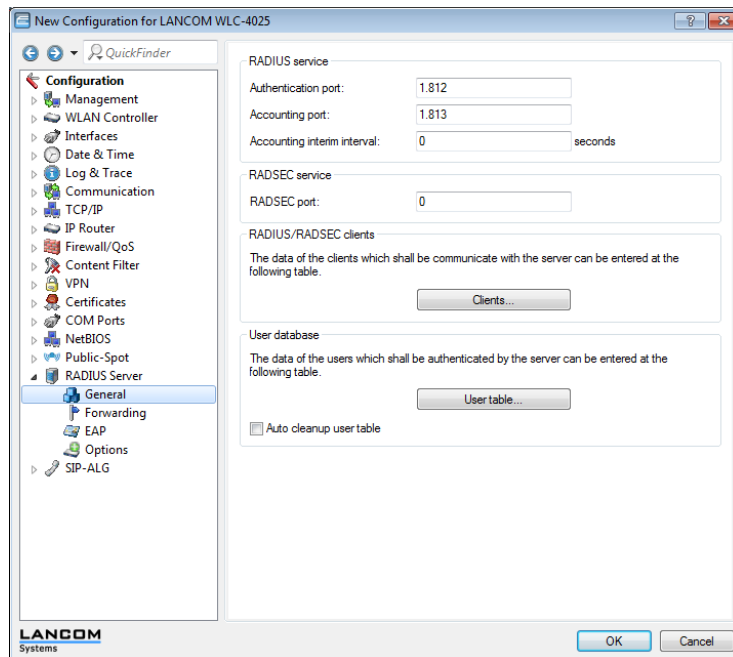

- Create an entry in the **authentication server** list of the Public Spot for the internal RADIUS server under **Name**, so that the Public Spot has the address of the RADIUS server and can authenticate Public Spot access attempts on the internal RADIUS server of the LANCOM device.  
Enter the IP address of the device as the authentication and accounting server where the RADIUS server was enabled. Also use the authentication and accounting port settings from the RADIUS server (1,812 and 1,813).

! If the Public Spot and the RADIUS server are provided by the same device, enter the device's internal loopback address (127.0.0.1) here.

- LANconfig: **Public Spot > Users > Authentication servers**

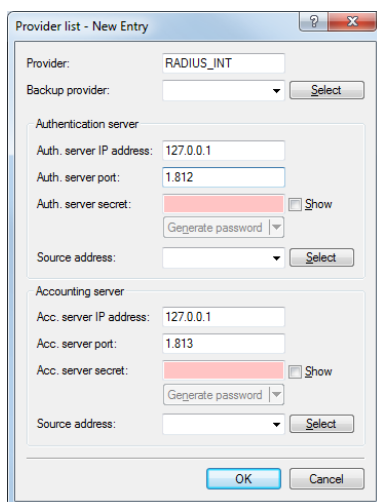

## Configuring Internet access for the guest network

- In order to provide Internet access for guest network users, there is a wizard to set up access to a provider network.
- Limit access to the provider network.  
In order for this access to be available to users of the guest network only, set the routing tag "10" for the corresponding route. This ensures that only data packets from the IP network "GUEST" with the interface tag "10" are transmitted

to the provider's network. The different routing tag values ensure that data cannot be routed between the guest network and the internal network.

- LANconfig: **IP router > Routing > Routing table**

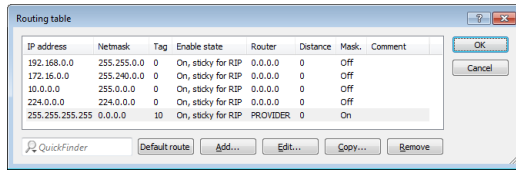

- Optional: If necessary, use **Device > Configuration Management > Upload certificate or file** in LANconfig to upload an HTML template and an image as a template to the device for output of the voucher. The image can be a GIF, JPEG or PNG file of max. 64 KB in size.

### 14.4.2 Virtualization and guest access via WLAN controller without VLAN

#### Overlay network: Separating networks for access points without using VLAN

In many cases, networks in a shared physical infrastructure are separated by using VLANs. However, this method assumes that the switches operated in the network are VLAN-capable and that these are configured for VLAN operations. Consequently, the administrator has to rollout the VLAN configuration for the whole network.

WLAN controllers enable you to separate the networks while minimizing the use of VLANs. The access points use a CAPWAP data tunnel to direct the payload from the WLAN clients straight to the controller, which then assigns the data to the corresponding VLANs. In this situation, VLAN configuration is only required for the controller and a single, central switch. All of the other switches in this example work without a VLAN configuration.

⚠ With this configuration, you reduce the VLAN to the core of the network structure (illustrated with a blue background). What's more, only 3 of the switch ports in use require a VLAN configuration.

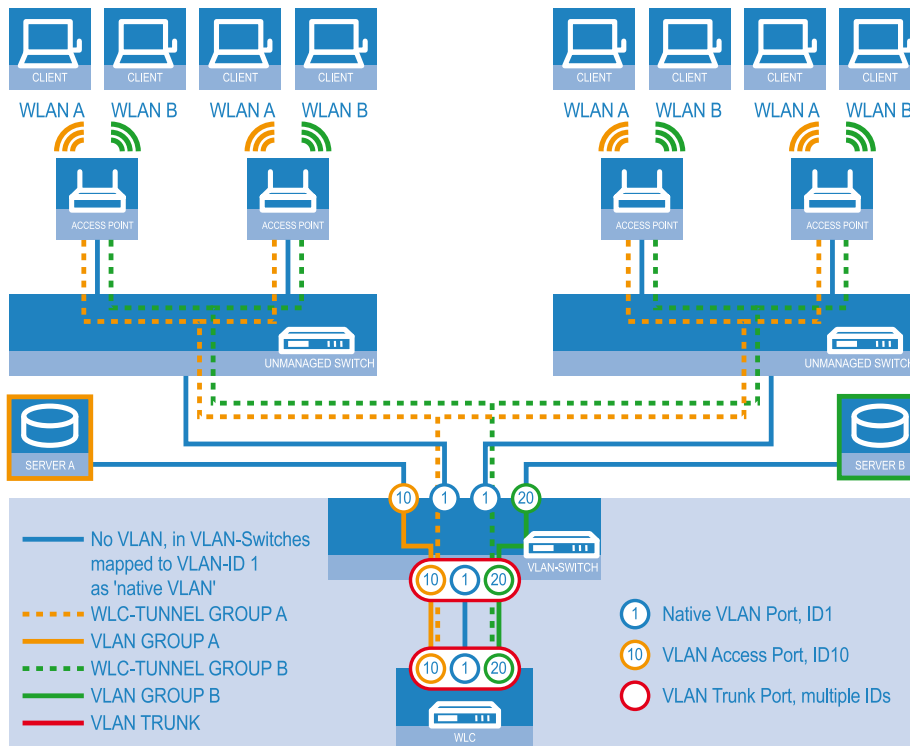

Example application: Overlay network

The diagram shows a sample application with the following components:

- The network consists of two segments, each with its own (not necessarily VLAN-capable) switch.
- Each segment contains several access points, each of which is connected to one of the switches.
- Each access point provides two SSIDs for the WLAN clients in two different user groups, shown in the diagram in green and orange.
- Each user group has access to its own dedicated server that is separated from other user group. The servers can only be accessed via the corresponding VLANs, i.e. through the access ports configured on the switch.
- A single WLAN controller manages all of the access points in the network.
- A central, VLAN-capable switch connects the switches in each segment, the servers for each group, and the WLAN controller.

The aim of the configuration: A WLAN client that associates with an SSID is to have access to its "own" server, regardless of which access point is being used and regardless of the segment in which the client is located.

 The following description assumes a working basic configuration of the WLAN controller. The configuration of the VLAN switch is not part of this description.

### Configuring the WLAN settings

1. For each SSID, create an entry in the list of logical networks. This entry requires a suitable name and the corresponding SSID. Connect the SSID to a WLC tunnel, for example the first SSID to "WLC-TUNNEL-1" and the second to "WLC-TUNNEL-2". Set the VLAN mode to 'tagged', set the VLAN ID '10' for the first logical network and the VLAN ID '20' for the second logical network. In LANconfig you find these settings under **Configuration > WLAN Controller > Profiles > Logical WLAN networks (SSIDs)**.

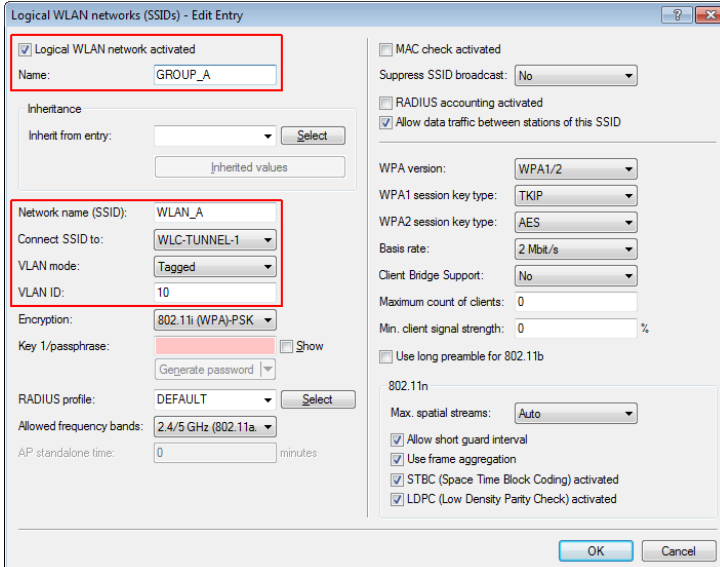

### Logical WLAN networks for overlay networks

2. Create an entry in the list of physical WLAN parameters with the appropriate settings for your access points, such as the country 'Europe' with the channels 1, 6 and 11 in 802.11b/g/n and 802.11a/n in mixed mode. For this profile in the physical WLAN parameters, enable the option to turn on the VLAN module on the access points. Set the

operating mode for the management VLAN in the access points to 'Untagged'. In LANconfig you find these settings under **Configuration > WLAN Controller > Profiles > Physical WLAN parameters**.

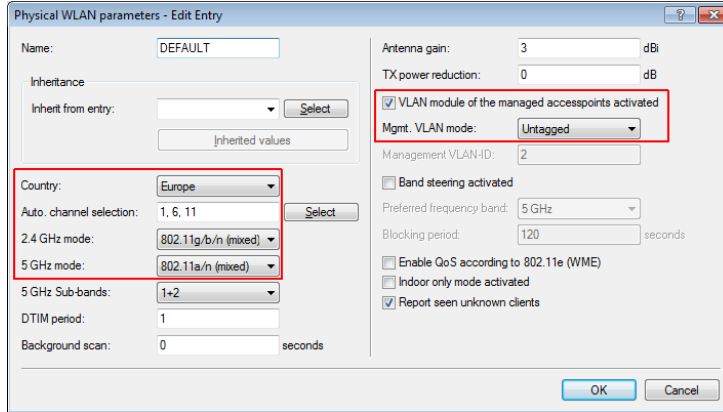

Physical WLAN parameters for overlay networks

3. Create a WLAN profile and give it a suitable name. Then assign the logical WLAN networks and the physical WLAN parameters created previously to this WLAN profile. In LANconfig you find these settings under **Configuration > WLAN Controller > Profiles > WLAN profiles**.

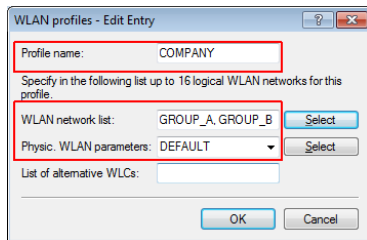

WLAN profiles for overlay networks

4. For each managed access point, create an entry in the access point table with a suitable name and the associated MAC address. Assign the WLAN profile created previously to this access point. In LANconfig you find these settings under **Configuration > WLAN Controller > AP config. > Access point table**.

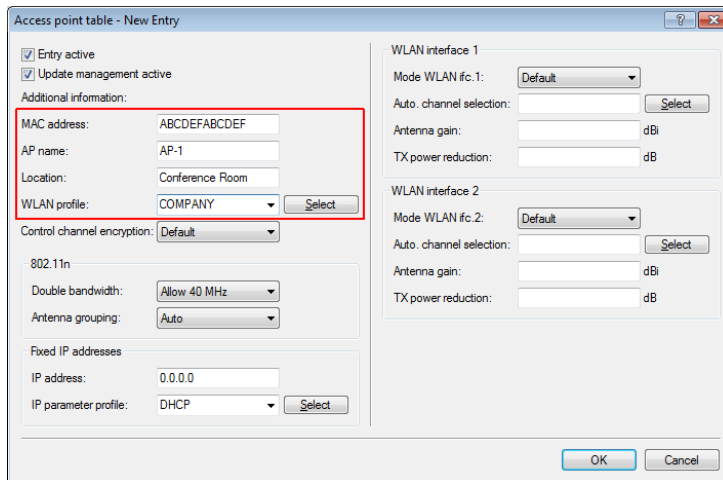

Access point table for overlay networks

## Configuring the interfaces on the WLC

- Assign a separate logical LAN interface, e.g. 'LAN-1', to each physical Ethernet port. Make sure that the other Ethernet ports are not assigned to the same LAN interface. In LANconfig you find these settings under **Configuration > Interfaces > LAN > Ethernet ports**.

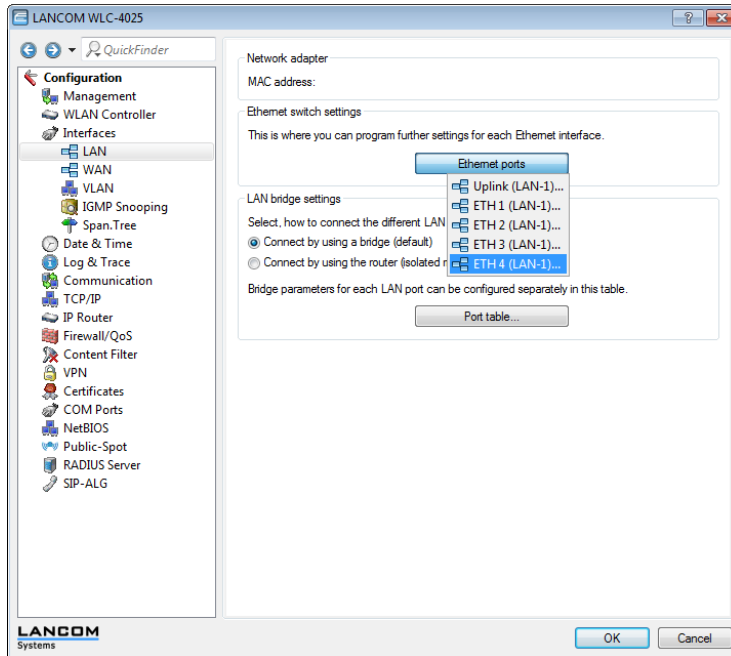

Ethernet setting for overlay networks

- Assign the logical LAN interface 'LAN-1' and the WLC tunnels 'WLC-tunnel-1' and 'WLC-tunnel-2' to the bridge-group 'BRG-1'. Make sure that the other LAN ports are not assigned to the same bridge group. In LANconfig you find these settings under **Configuration > Interfaces > LAN > Port table**.

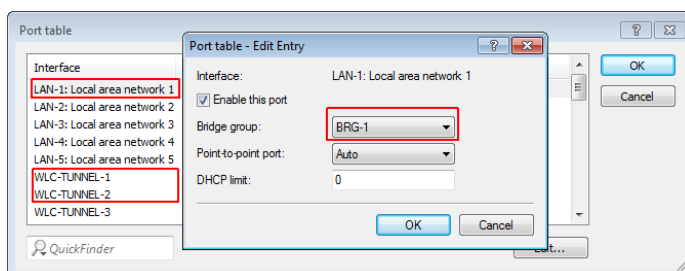

Port settings for overlay networks

- ⚠ By default, the LAN interfaces and WLC tunnels do not belong to a bridge group. By assigning the LAN interface 'LAN-1' and the two WLC tunnels 'WLC-Tunnel-1' and 'WLC-Tunnel-2' to the bridge group 'BRG-1', the device transmits all data packets between LAN-1 and the WLC tunnels via the bridge.

- The WLAN controller can optionally act as a DHCP server for the access points. To set this up, activate the DHCP server for the 'INTRANET'. In LANconfig you find these settings under **Configuration > TCP/IP > DHCP > DHCP networks**.

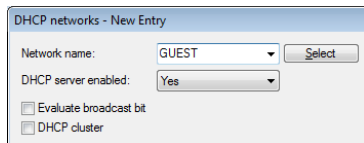

DHCP settings for overlay networks

## WLAN controller with Public Spot

This scenario is based on the first scenario (overlay network) and enhances it to include specific settings for user authentication.

The configuration of a Public Spot can be greatly simplified if the payload data sent from the WLAN to the controller is routed through a WLC tunnel. A Public Spot can, for example, provide guests with Internet access in parallel with, but separated from, an internal wireless LAN.

In this example, the employees of a company have access to a private WLAN (SSID), while the guests use a Public Spot to access the Internet. In all areas of the building, the access points provide two SSIDs, 'COMPANY' and 'GUESTS'.

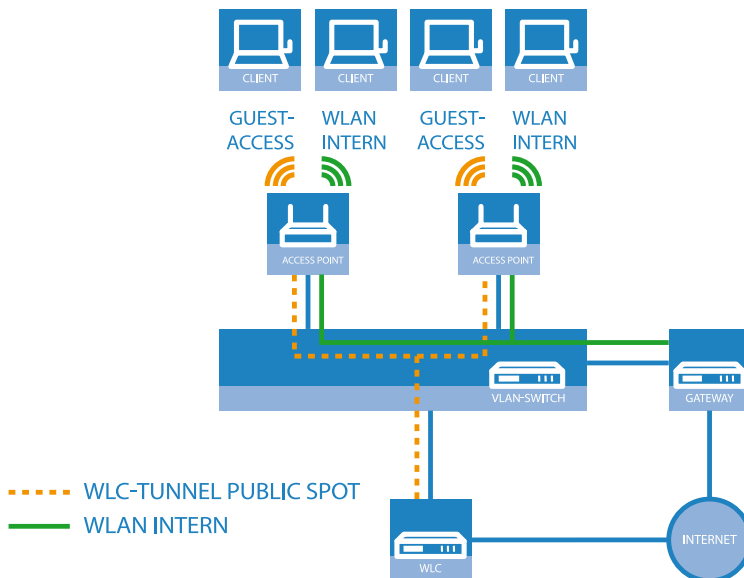

Example application: WLAN controller with Public Spot

The aim of the configuration: A WLAN client that associates with the internal SSID should have access to all internal resources and the Internet via the central gateway. The access points break-out the payload data from the internal clients locally and pass it on directly to the LAN. The guests' WLAN clients associate with the Public Spot. The access points send the payload data from the guest clients through a WLC tunnel directly to the WLAN controller, which uses a separate WAN interface for Internet access.

- The internal WLAN and the guest WLAN each require an entry to be created in the list of logical networks, each with a suitable name and the corresponding SSID. Link the SSID for internal use with the 'LAN at AP', and the SSID for guests with (for example) 'WLC-TUNNEL-1'. Disable encryption for the guest network SSID so that the guests' WLAN

clients can associate with the Public Spot. You should also prevent inter-station traffic for this SSID. In LANconfig you find this setting under **Configuration > WLAN Controller > Profiles > Logical WLAN networks (SSIDs)**.

The screenshot shows the 'Logical WLAN networks (SSIDs) - Edit Entry' dialog box. The 'Logical WLAN network activated' checkbox is checked. The 'Name' field is 'COMPANY'. The 'Network name (SSID)' is 'WLAN-INTERNAL' and 'Connect SSID to' is 'LAN at AP'. The 'Encryption' is set to '802.11i (WPA)-PSK'. The 'Allow data traffic between stations of this SSID' checkbox is checked. Other settings include WPA version: WPA1/2, WPA1 session key type: TKIP, WPA2 session key type: AES, Basis rate: 2 Mbit/s, Client Bridge Support: No, Maximum count of clients: 0, Min. client signal strength: 0%, and various 802.11n options like Max. spatial streams: Auto, Allow short guard interval, Use frame aggregation, STBC, and LDPC are checked.

#### Logical WLAN networks for internal use

The screenshot shows the 'Logical WLAN networks (SSIDs) - Edit Entry' dialog box. The 'Logical WLAN network activated' checkbox is checked. The 'Name' field is 'GUEST'. The 'Network name (SSID)' is 'WLAN-PUBLIC' and 'Connect SSID to' is 'WLC-TUNNEL-1'. The 'Encryption' is set to 'None'. The 'Allow data traffic between stations of this SSID' checkbox is unchecked. Other settings include WPA version: WPA1/2, WPA1 session key type: TKIP, WPA2 session key type: AES, Basis rate: 2 Mbit/s, Client Bridge Support: No, Maximum count of clients: 0, Min. client signal strength: 0%, and various 802.11n options like Max. spatial streams: Auto, Allow short guard interval, Use frame aggregation, STBC, and LDPC are checked.

#### Logical WLAN networks for guest access accounts

## 14 Public Spot

2. Create an entry in the list of physical WLAN parameters with the appropriate settings for your access points, such as the country 'Europe' with the channels 1, 6 and 11 in 802.11b/g/n and 802.11a/n in mixed mode. In LANconfig you find this setting under **Configuration > WLAN Controller > Profiles > Physical WLAN parameters**.

Physical WLAN parameters - Edit Entry

Name: DEFAULT

Inheritance: Inherit from entry: [Select] Inherited values

Country: Europe

Auto. channel selection: 1, 6, 11

2.4 GHz mode: 802.11g/b/n (mixed)

5 GHz mode: 802.11a/n (mixed)

5 GHz Sub-bands: 1+2

DTIM period: 1

Background scan: 0 seconds

Antenna gain: 3 dBi

TX power reduction: 0 dB

VLAN module of the managed accesspoints activated

Mgmt. VLAN mode: Untagged

Management VLAN ID: 2

Band steering activated

Preferred frequency band: 5 GHz

Blocking period: 120 seconds

Enable QoS according to 802.11e (WME)

Indoor only mode activated

Report seen unknown clients

OK Cancel

## Physical WLAN parameters for Public Spot APs

3. Create a WLAN profile and give it a suitable name. Then assign the logical WLAN networks and the physical WLAN parameters created previously to this WLAN profile. In LANconfig you find this setting under **Configuration > WLAN Controller > Profiles > WLAN profiles**.

WLAN profiles - Edit Entry

Profile name: COMPANY

Specify in the following list up to 16 logical WLAN networks for this profile.

WLAN network list: COMPANY, GUEST

Physic. WLAN parameters: DEFAULT

List of alternative WLCs:

OK Cancel

## WLAN profiles for Public Spot APs

4. For each managed access point, create an entry in the access point table with a suitable name and the associated MAC address. Assign the WLAN profile created previously to this access point. In LANconfig you find this setting under **Configuration > WLAN Controller > AP config. > Access point table**.

Access point table - New Entry

Entry active

Update management active

Additional information:

MAC address: ABCDEFABCDEF

AP name: AP-1

Location: Conference Room

WLAN profile: COMPANY

Control channel encryption: Default

802.11n

Double bandwidth: Allow 40 MHz

Antenna grouping: Auto

Fixed IP addresses

IP address: 0.0.0.0

IP parameter profile: DHCP

WLAN interface 1

Mode WLAN fc. 1: Default

Auto. channel selection: [Select]

Antenna gain: [ ] dBi

TX power reduction: [ ] dB

WLAN interface 2

Mode WLAN fc. 2: Default

Auto. channel selection: [Select]

Antenna gain: [ ] dBi

TX power reduction: [ ] dB

OK Cancel



### Access point table for Public Spot APs

- Assign a separate logical LAN interface, e.g. 'LAN-1', to each physical Ethernet port. Set the 4th Ethernet port to the logical interface 'DSL-1'. The WLAN controller will use this LAN interface for the guest network Internet access. In LANconfig you find this setting under **Configuration > Interfaces > LAN > Ethernet ports**.

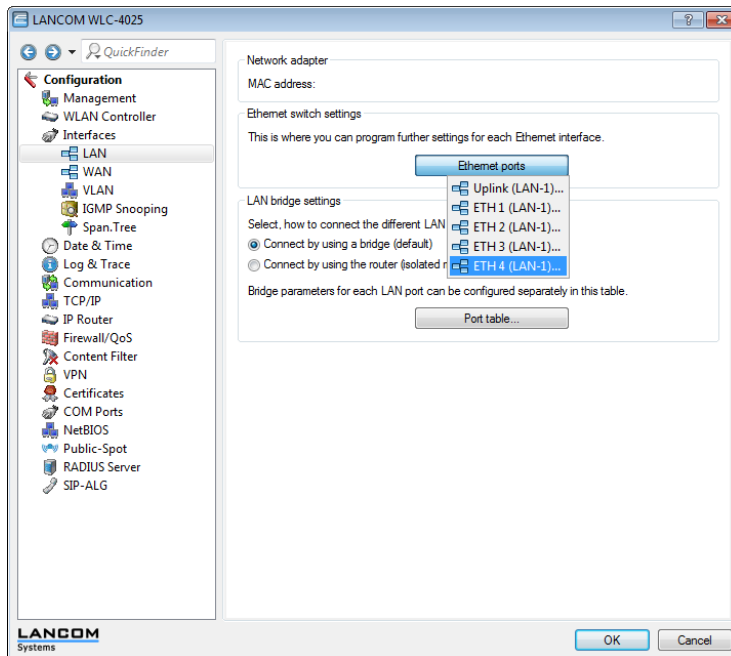

### Ethernet settings for Public Spot APs

- Verify that the logical LAN interface 'WLC-tunnel-1' is not allocated to a bridge group. This ensures that the other LAN interfaces do not transmit any data to the Public Spot. In LANconfig you find this setting under **Configuration > Interfaces > LAN > Port table**.

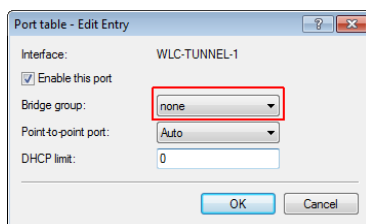

### Port settings for Public Spot APs

7. For the guest Internet access, create an entry in the list of DSL remote sites with the hold time '9999' and the pre-defined layer 'DHCP'. This example assumes that Internet access is provided by a router with DHCP server. In LANconfig you find this setting under **Configuration > Communications > Remote sites > Remote sites**.

Remote sites - Edit Entry

Name: INTERNET

Short hold time: 9.999 seconds

Access concentrator:

Service:

Layer name: DHCP Select

MAC address type: Local

MAC address:

DSL ports: Select

VLAN ID: 0

OK Cancel

Remote site for Internet access

8. For internal users, create the IP network 'INTRANET' with (for example) the IP address '192.168.1.100' and the interface tag '1'. For the guest access, create the IP network 'GUEST-ACCESS' with (for example) the IP address of '192.168.200.1' and the interface tag '2'. The virtual router in the WLAN controller uses the interface tags to separate the routes for the two networks. In LANconfig you find this setting under **Configuration > TCP/IP > General > IP networks**.

IP networks - Edit Entry

Network name: INTRANET OK

IP address: 192.168.1.100 Cancel

Netmask: 255.255.255.0

Network type: Intranet

VLAN ID: 0

Interface assignment: Any

Address check: Loose

Interface tag: 1

Comment:

IP network for internal use

IP networks - Edit Entry

Network name: GUEST OK

IP address: 192.168.200.1 Cancel

Netmask: 255.255.255.0

Network type: Intranet

VLAN ID: 0

Interface assignment: Any

Address check: Loose

Interface tag: 2

Comment:

IP network for guest access

9. The WLAN controller can act as a DHCP server for access points and the associated WLAN clients. To set this up, activate the DHCP server for the 'INTRANET' and the 'GUEST-ACCESS'. In LANconfig you find this setting under **Configuration > TCP/IP > DHCP > DHCP networks**.

- ! Activation of the DHCP server is obligatory for the guest network and optional for the internal network. There are other ways of realizing a DHCP server for the internal network.

#### DHCP network for guest access

10. Create a new default route in the routing table to direct the data from the guest network to the Internet connection used by the WLAN controller. Select the routing tag '2' and the router 'Internet'. Also activate the option 'Masking intranet and DMZ (default)'. In LANconfig you find this setting under **Configuration > IP router > Routing > Routing table**.

#### Routing entry for Internet access

11. Activate the Public Spot user authentication for the logical LAN interface 'WLC-Tunnel-1'. In LANconfig you find this setting under **Configuration > Public Spot > Server > Interfaces**.

#### Activation of user authentication for the WLC tunnel

12. The final step is to enable authentication via the Public Spot for the WLAN controller. In LANconfig you find this setting under **Configuration > Public Spot > Authentication**.

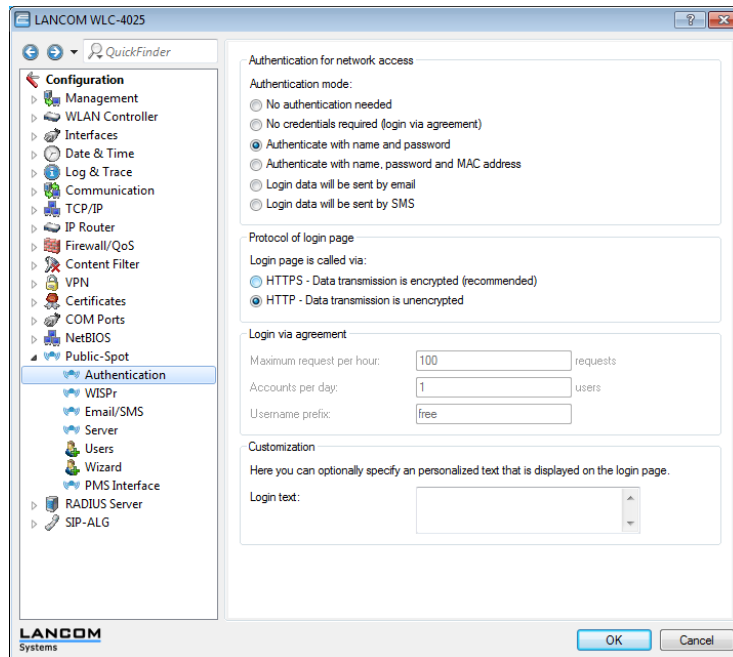

#### Activation of authentication via Public Spot

In addition to configuring the WLAN controller, you must also configure the Public Spot either to use the internal user list or to use a RADIUS server, according to your needs.

### 14.4.3 Setting up an external RADIUS server for user administration

Some applications user data is not stored on the device, but on an external, centralized RADIUS server. In this case, the Public Spot must communicate with the external RADIUS server to check the user data.

⚠ Please note that specific functions (such as the Public Spot wizards in WEBconfig) are not available to you if you use an external RADIUS server for user administration!

⚠ The following instructions assume that you know the IP address of a functional RADIUS server in the network.

The following configuration steps are used to set up a Public Spot that will be used with an external RADIUS server:

1. Follow the steps in the section [Manual Installation](#).

Among other things, the exact time on the device is necessary for the proper control of time-limited access.

⚠ If authentication with an additional check of the physical address (MAC address) is enabled, the Public Spot transmits the MAC address of the end device to the RADIUS server. In this manner the Public Spot does not see whether the MAC address was actually checked or not. For MAC address checks to work without problem, the RADIUS server must be configured accordingly.

2. Enter the settings for the RADIUS server.

- LANconfig: **Public Spot > Users > Authentication servers**

When configuring a Public Spot, user registration data can be forwarded to one or more RADIUS servers. These servers are configured under **Public Spot > Users > Authentication servers**. The registration data that individual

RADIUS servers require from the clients is not important to the device that provides the Public Spot, since this data is transparently passed on to the RADIUS server.

! IP addresses specified here must be static. The Public Spot must be able to contact the specified destination addresses. For IP addresses outside of your own network, a router that has contact to the destination network must be specified as a gateway in the DHCP settings for the Public Spot. You have to define this gateway as the default route in the routing table.

! In order for the RADIUS server to record the connection data, the information on the accounting server must be specified in full. As an alternative to using a RADIUS accounting server, the connection information from the Public Spot can also be output by the SYSLOG function.

### 3. That's it!

Your Public Spot is now ready for operation. All users with a valid account on the RADIUS server can use the Web interface to login to the Public Spot.

## 14.4.4 Internal and external RADIUS servers combined

Some companies use an external RADIUS server to authenticate users with IEEE801.1x. For applications with a WLAN controller and multiple access points, the access points initially address the WLAN controller as their RADIUS server. You define how the RADIUS requests are forwarded to the external RADIUS server on the WLAN controller.

! The settings described below are only necessary if you are operating an external RADIUS server on your device in addition to the Public Spot in the external RADIUS server.

A Public Spot providing guest-access accounts requires the following settings:

- Authentication requests from internal employees are to be forwarded to an external RADIUS server.
- The authentication requests for Public Spot access accounts are to be handled by the internal RADIUS server.

### Realm tagging for RADIUS forwarding

Authentication requests from the two user groups are to be handled separately. The WLAN controller uses what are known as "realms" to differentiate between these two groups. The purpose of realms is to address domains within which user accounts are valid. The WLAN controller can transmit the realms with authentication requests to the RADIUS server. Alternatively, the RADIUS server can change the realms in the user names for the purpose of RADIUS forwarding:

- The value defined for "Standard realm" replaces an existing realm of an incoming request if no forwarding is defined for that existing realm.
- The value defined under "Empty realm" is **only** used by the RADIUS server if the incoming user name **still does not** have a realm.

An entry in the forwarding table causes all authentication requests with a certain realm to be forwarded to a RADIUS server. If no matching entry exists in the forwarding table, the request is refused.

**!** If the WLAN controller checks the realm and finds that it is empty, it **always** checks the authentication request with the internal RADIUS database.

The following flow diagram illustrates the method used by the RADIUS server to process realms:

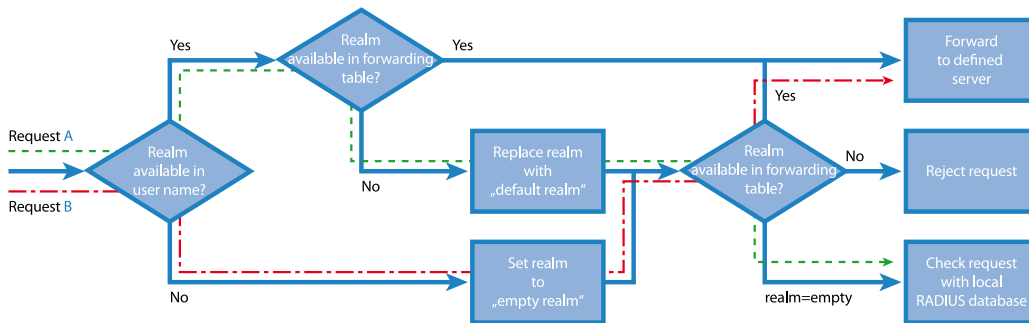

Using different realm tags allows different RADIUS servers to be targeted with requests. The way in which LANCOM's RADIUS server makes decisions for the two requests is shown in the diagram:

1. Because the user names for guest access accounts are generated automatically, they are suffixed with an appropriate realm, such as "PSpot". Because the forwarding table does not contain this entry and the standard realm is empty, the WLAN controller forwards all authentication requests with this realm to the internal RADIUS server.
2. To limit the amount of work required for the configuration, internal users are listed without a realm. The RADIUS server in the LANCOM can automatically replace an empty realm with another realm in order to identify internal users. In this example, the empty realm is replaced by the domain of the company "company.eu". The information specified in the forwarding table allows all authentication requests with this realm to be forwarded to the external RADIUS server.

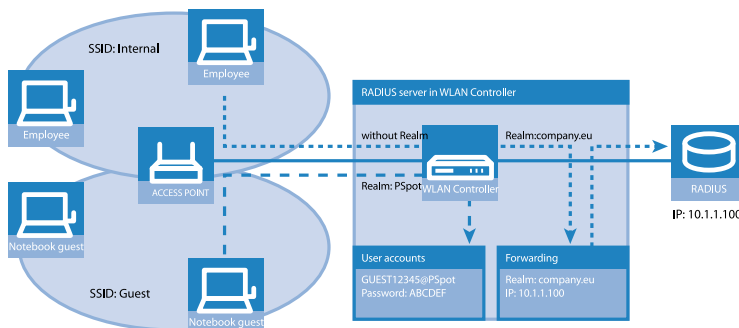

### Configuring RADIUS forwarding

The following configuration steps allow you to specify the different manners in which internal users and guests are processed.

1. In the Public Spot, adapt the pattern of user names such that a unique realm can be suffixed. For example, if the pattern is "user%n@PSpot", the Public Spot generates usernames with the format "user12345@PSpot".

- LANconfig:Public Spot > Wizard > Add user wizard

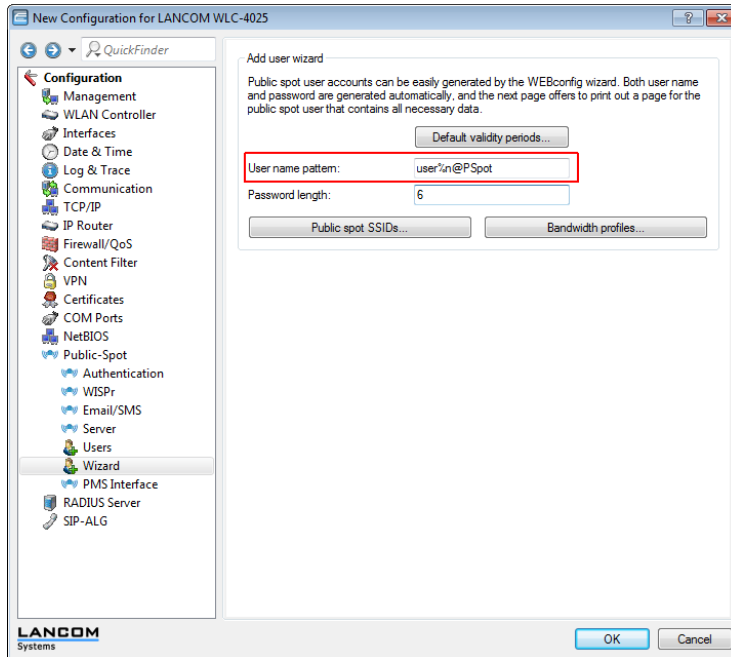

- In the WLAN controller's RADIUS server, define an "empty realm" (e.g., "COMPANY.EU"). This realm is attached to all user names which request authentication from the WLAN controller and which do not already have a realm. In this application, the internal users have no realm defined. In order to prevent the WLAN controller's RADIUS server from attaching a realm, you must leave the "Default realm" field blank.

- LANconfig:RADIUS Server > Forwarding > Forwarding server

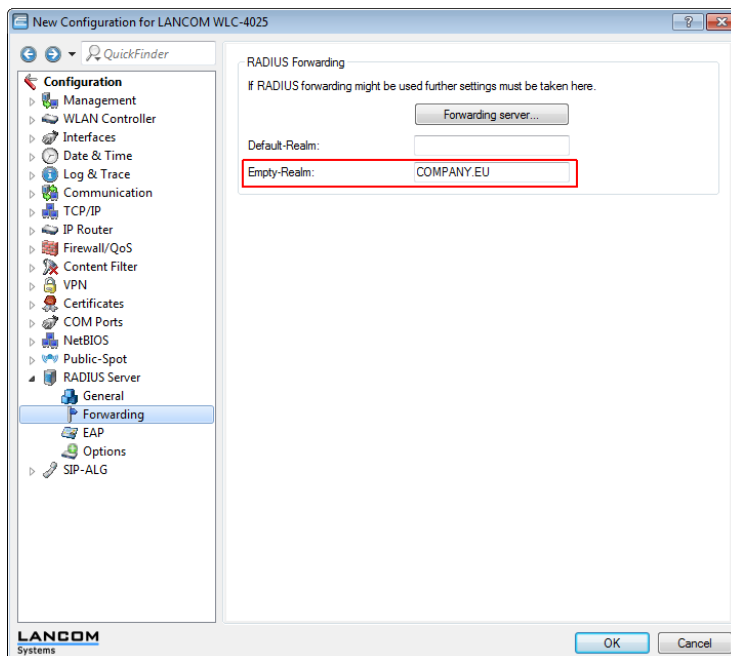

- In order for the WLAN controller to forward authentication requests from internal users to the external RADIUS server, suitable entries must be made in the forwarding settings.

All incoming RADIUS requests which have the realm "COMPANY.EU" will be forwarded to the specified IP address.

The screenshot shows a dialog box titled "Forwarding server - New Entry". It has several sections:
 

- Realm:** A text field containing "COMPANY.EU".
- Backup profile:** A dropdown menu with a "Select" button.
- Authentication server:**
  - IP address:** A text field containing "10.1.1.1".
  - Port:** A text field containing "1.812".
  - Secret:** A password field with a "Show" checkbox and a "Generate password" button.
  - Source address:** A dropdown menu with a "Select" button.
  - Protocol:** A dropdown menu set to "RADIUS".
- Accounting server:**
  - IP address:** A text field containing "0.0.0.0".
  - Port:** A text field containing "1.813".
  - Secret:** A password field with a "Show" checkbox and a "Generate password" button.
  - Source address:** A dropdown menu with a "Select" button.
  - Protocol:** A dropdown menu set to "RADIUS".

 At the bottom are "OK" and "Cancel" buttons.

- Authentication requests from Public Spot users have the realm "@PSpot" and are received by the WLAN Controller. With no forwarding defined for this realm, the usernames are automatically checked with the internal RADIUS database. Because the Public Spot access accounts created with the Wizard are stored in this database, these requests can be authenticated as required.

### 14.4.5 Checking WLAN clients with RADIUS (MAC filter)

To use RADIUS to only authenticate specific WLAN clients and grant them WLAN access based on their MAC address, an external RADIUS server can be used, as can the internal RADIUS user database of the LANCOM WLAN controller.

Enter the MAC addresses in the RADIUS database using LANconfig, and enable all authentication methods. For **Name/MAC address** and **Password** select the corresponding MAC address in the format "AABBCC-DDEEFF".

- LANconfig: **RADIUS server > General > User database**

The screenshot shows a dialog box titled "User table - New Entry". It is divided into several sections:
 

- Name / MAC address:** A text field.
- Case sensitive username check:** A checked checkbox.
- Password:** A password field with a "Show" checkbox and a "Generate password" button.
- VLAN ID:** A text field containing "0".
- Comment:** A text area.
- Service type:** A dropdown menu set to "Any".
- Protocol restriction for authentication:**
  - PAP
  - MSCHAP
  - EAP
  - CHAP
  - MSCHAPv2
- Passphrase (optional):** A password field with a "Show" checkbox and a "Generate password" button.
- TX bandwidth limit:** A text field containing "0" with "kbit/s" next to it.
- RX bandwidth limit:** A text field containing "0" with "kbit/s" next to it.
- Station mask:**
  - Calling station:** A text field.
  - Called station:** A text field.
- Validity/Expiry:**
  - Expiry type:** A dropdown menu set to "Relative & absolute".
  - Relative expiry:** A text field containing "0".
  - Absolute expiry:** A text field containing ". . ." followed by "00 : 00 : 00".
  - Multiple login
  - Max. concurrent logins:** A text field containing "0".
  - Time budget:** A text field containing "0" with "seconds" next to it.
  - Volume budget:** A text field containing "0" with "byte" next to it.

 At the bottom are "OK" and "Cancel" buttons.

### 14.4.6 Setting up an external SYSLOG server

Depending on the use case, storage of the usage data is required for the operation of a Public Spot. This data can be stored to a SYSLOG server, for example. Some SYSLOG servers are available as free software.



To save user data from a Public Spot by means of SYSLOG, the external SYSLOG server has to be configured in the respective Public Spot. Once this is done, messages are sent for logging to the SYSLOG server whenever Public Spot user accounts are created or deleted, and at the beginning and end of Public Spot sessions. The message issued at the end of a session—with the source "Login" and the priority "Information"—also includes information on the transferred data volumes and the IP address used.

! Further information on the configuration of SYSLOG is to be found in the LCOS Reference Manual. You can find legal information about this topic in the LANCOM techpaper "Public Spot" which is available at [www.lancom-systems.de/en/publications/products](http://www.lancom-systems.de/en/publications/products).

## Configuring an external SYSLOG server

Your device is capable of logging the creation and deletion of Public Spot users, as well as their login and logout activities. You can also transfer this internally stored information to an external SYSLOG server. The following steps show you how you can set up logging with a program installed on an external SYSLOG server (in this example, "Kiwi").

1. Start LANconfig and open the configuration dialog for your device.
2. Change to the dialog **Log & Trace > General** and open the table **SYSLOG servers**.
3. Add a new entry Specify the **IP address** of the computer where the SYSLOG client is installed (e.g., 192.168.10.237), and enter the **Source** (Login, Accounting) and the **Priority** (Information).

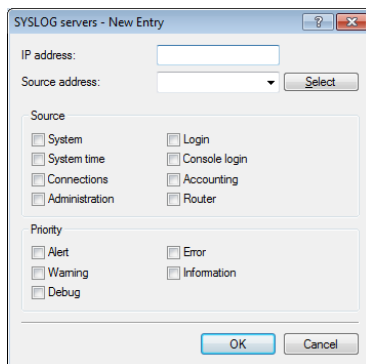

4. Close the dialog and store the configuration on your device.
5. Start the analysis program on your SYSLOG server (e.g., "Kiwi"). As soon as the program has started, it logs the creation and deletion of Public Spot accounts and also the user logins and logouts.

Date	Time	Priority	Hostname	Message
05-29-2008	14:17:58	Auth.Notice	192.168.10.31	CONN-LOGIN_INFO: User account 'user58567' deleted [manually deleted by root]<000>
05-29-2008	14:17:27	Auth.Notice	192.168.10.31	CONN-LOGIN_INFO: Finished session for user 'user58567' (IP address was 192.168.10.214, accounting data: Tx 283298, Rx 39102, Seconds 60)<000>
05-29-2008	14:16:28	Auth.Notice	192.168.10.31	CONN-LOGIN_INFO: Started session for user 'user58567' (IP address is
05-29-2008	14:15:36	Auth.Notice	192.168.10.31	CONN-LOGIN_INFO: [WLAN-2] Determined IP address for station 00:10:c6:49:cd:fd (USI 49:cd:fd) [MARKUS-MOBIL]: 192.168.10.214<000>
05-29-2008	14:15:07	Auth.Notice	192.168.10.31	CONN-LOGIN_INFO: [WLAN-2] Determined IP address for station 00:10:c6:49:cd:fd (USI
05-29-2008	14:15:07	Auth.Notice	192.168.10.31	CONN-LOGIN_INFO: [WLAN-2] Connected WLAN station 00:10:c6:49:cd:fd (USI 49:cd:fd)
05-29-2008	14:15:07	Auth.Notice	192.168.10.31	CONN-LOGIN_INFO: [WLAN-2] Associated WLAN station 00:10:c6:49:cd:fd (USI 49:cd:fd)
05-29-2008	14:15:07	Auth.Notice	192.168.10.31	CONN-LOGIN_INFO: [WLAN-2] Authenticated WLAN station 00:10:c6:49:cd:fd (USI
05-29-2008	14:13:03	Auth.Notice	192.168.10.31	CONN-LOGIN_INFO: User account 'user58567' created [created by root on 29.05.2008

## 14.5 Appendix

### 14.5.1 Commonly transmitted RADIUS attributes

The RADIUS client module was implemented on the basis of RFCs no. 2865 and no. 2866.

These specifications define various attributes, some of which are an absolute necessity and some of which are optional. The following overview shows which attributes are transmitted/processed in messages between RADIUS servers and base stations.

#### Messages to/from the authentication server

##### Transferred attributes

As previously mentioned, your device transmits far more than just the username and password in a RADIUS request. RADIUS servers might choose to completely ignore these additional attributes, or only use a subset of these attributes. Many of these attributes are used for access to the server using dial-in, and are defined as standard attributes in the RADIUS RFCs. However, some important information for hotspot operation can not be represented with standard attributes. For this reason LANCOM has chosen to provide these values as vendor-specific attributes, marked with LANCOM's enterprise ID (2356).

#### Overview of the RADIUS attributes transmitted by the device to the authentication server

1

##### User name

The name entered by the user.

2

##### User-Password

The password entered by the user.

4

##### NAS-IP-Address

IP address of your device

6

##### Service-Type Id 1

Type of service that the user requested. The value 1 stands for **Login**.

8

##### Framed-IP-Address

IP address that was assigned to the client

26

##### Vendor 2356(LCS) ID 2

MAC address of the client if authentication using the MAC address is enabled. In contrast to the Calling-Station-Id, this value is transmitted as a 6-byte binary string. This attribute only exists for the login mode **Authenticate with name, password and MAC address**.

30

##### Called-Station-Id

MAC address of your device

31

**Calling-Station-Id**

MAC address of the client. The address is given byte-wise in hexadecimal notation with separators (nn:nn:nn:nn:nn:nn).

32

**NAS-identifier**

Name of your device, if configured.

61

**NAS-Port-Type**

Type of physical port over which a user had requested authentication.

- ID 19 denotes clients from WLAN
- ID 15 denotes clients from Ethernet

87

**NAS-Port-Id**

Description of the interface over which the client is connected to your device. This can be a physical as well as a logical interface, such as LAN-1, WLAN-1-5 or WLC-TUNNEL-27.



Consider that more than one client may be connected to one interface at a time, so that, unlike dial-in servers, port numbers are not unique for clients.

**Processed attributes**

Your device evaluates the authentication response of a RADIUS server for attributes that it may possibly process further. Most attributes however only have a meaning if the authentication response was positive, so that they influence the subsequent session:

**Overview of the RADIUS attributes processed by the device**

18

**Reply-Message**

An arbitrary string from the RADIUS server that may transport either a login failure reason or a user welcome message. This message may be integrated into user-defined start or error pages via the SEVERMSG element.

25

**Class**

An arbitrary octet string that may contain data provided by the authentication/accounting backend. Whenever the device sends RADIUS accounting requests, they will contain this attribute as-is. Within an authentication response, this attribute can occur multiple times in order, for example, to transmit a string that is longer than 255 bytes. The device processes all occurrences in accounting requests in the order they appeared in the authentication response.

26

**Vendor 2356(LCS) ID 1****Trafficlimit**

Defines the data volume in bytes after which the device automatically ends the session. This value is useful for volume-limited accounts. If this attribute is missing in the authentication response, it is assumed that no volume limit applies. A traffic limit of 0 is interpreted as an account which is principally valid, however with a used-up volume budget. The device does not start a session in this case.

26

**Vendor 2356(LCS) ID 3**

**LCS-Redirection-URL**

This can contain any URL that is offered as an additional link on the start page. This can be the start page of the user or a page with additional information about the user account.

26

**Vendor 2356(LCS) ID 5****LCS-Account-End**

Defines an absolute point in time (measured in seconds since January 1, 1970 0:00:00) after which the account becomes invalid. If this attribute is missing, an unlimited account is assumed. The device does not start a session if its internal clock has not been set, or the given point in time is in the past.

26

**Vendor 2356(LCS) ID 8****LCS-Public Spot-Username**

Contains the name of a Public Spot user for auto-login. Auto-login refers to the table of MAC authenticated users who are automatically assigned usernames by the server.

26

**Vendor 2356(LCS) ID 8****LCS-TxRateLimit**

Defines the maximum downstream rate in kbps. This restriction may be combined with the corresponding Public Spot function.

26

**Vendor 2356(LCS) ID 9****LCS-RxRateLimit**

Defines the maximum upstream rate in kbps. This restriction may be combined with the corresponding Public Spot function.

27

**Session-Timeout**

Defines an optional maximum duration of the session, measured in seconds. If this attribute is missing in the response, an unlimited account is assumed. A Session timeout of zero seconds is interpreted as an account which is principally valid, however with a used-up time budget. The device does not start a session in this case.

28

**Idle timeout**

Defines a time period in seconds after which the device will terminate the session if no packets were received from the client. This value overwrites in the locally defined idle timeout under **Public Spot > Server > Idle timeout**.

64

**Tunnel-Type**

Defines the tunneling protocol which will be used for the session.

65

**Tunnel-Medium-Type**

Defines the transport medium over which the tunneled session will be established.

81

**Tunnel-Private-Group-ID**

Defines the group ID if the session is tunneled.

85

**Acct-Interim-Interval**

Defines the amount of time between subsequent RADIUS accounting updates. This value is only evaluated if the RADIUS client does not have a local accounting interval defined, i.e. if you have not set an **Accounting update cycle** for the Public Spot module.



Note that the LCS-Account-End and Session-Timeout attributes are mutually exclusive, and it therefore does not make sense to include both in the response. If both attributes are included in a response, the attribute that appears as the last one in the attribute list will define the session's time limit.

**Messages to/from the accounting server****Transferred attributes**

The set of RADIUS attributes transmitted to a RADIUS server in an accounting request is similar to the set of attributes transmitted in an authentication request. However, additional attributes specific to accounting will be added. The following attributes are present in all RADIUS accounting requests:

**Overview of the RADIUS attributes transmitted by the device to the accounting server**

1

**User name**

Name of the account that was used for authentication.

4

**NAS-IP-Address**

IP address of your device

8

**Framed-IP-Address**

IP address that was assigned to the client

25

**Class**

All class attributes that the RADIUS authentication server sent in its authentication response.

30

**Called-Station-Id**

MAC address of your device

31

**Calling-Station-Id**

MAC address of the client The address is given byte-wise in hexadecimal notation with separators (nn:nn:nn:nn:nn:nn).

32

**NAS-identifier**

Name of your device, if configured.

40

**Acct-Status-Type**

Request type which signals the start or stop of accounting, or an interim update. Please refer to the section [Request types](#) for further information.

44

**Acct-Session-Id**

A series of characters that uniquely identify the client. It consists of the MAC address of the network adapter, the login timestamp (measured in seconds since January 1, 1970 0:00:00), and the session counter that your device manages locally.

61

**NAS-Port-Type**

Type of physical port over which a user had requested authentication.

- **ID 19** denotes clients from WLAN
- **ID 15** denotes clients from Ethernet

87

**NAS-Port-Id**

Description of the interface over which the client is connected to your device. This can be a physical as well as a logical interface, such as `LAN-1`, `WLAN-1-5` or `WLC-TUNNEL-27`.



Consider that more than one client may be connected to one interface at a time, so that, unlike dial-in servers, port numbers are not unique for clients.

In the case of an accounting stop request or an interim update, the request contains the following additional attribute:

42

**Acct-Input-Octets**

The sum of all data bytes received from the client in this session, modulo  $2^{32}$ .

43

**Acct-Output-Octets**

The sum of all data bytes sent to the client in this session, modulo  $2^{32}$ .

46

**Acct-Session-Time**

The total duration of the client's session in seconds.



If the session was ended due to an idle timeout, this value is reduced by the idle time.

47

**Acct-Input-Packets**

The number of data packets that your device received from the client during the session.

48

**Acct-Output-Packets**

The number of data packets that your device sent to the client during the session.

49

**Acct-Terminate-Cause**

The reason for termination or the end of the accounting session. This is sent if **Acct-Status-Type** has the value `Start` or `Stop`.

52

**Acct-Input-Gigawords**

The upper 32 bits of the sum of all data bytes received from the client during this session.

53

**Acct-Output-Gigawords**

The upper 32 bits of the sum of all data bytes sent to the client during this session.

55

**Event-Timestamp**

The elapsed time since this accounting request was submitted by the device, measured in seconds since January 1, 1970 0:00:00. This attribute is only present if your device's real time clock contains a valid value.



Note that the RADIUS accounting only starts accounting after a client successfully logs in, i.e. the time needed for authentication is not recorded. Using *Traffic-Limit-Option* you can limit the data traffic during the authentication phase. The final accounting stop request also contains the termination cause attribute (49). An overview of these attributes can be found in the LANCOM "Public Spot: Implementation Guide".

**Processed attributes**

Your device currently does not process any attributes in responses sent by a RADIUS accounting server.

## 14.5.2 RADIUS attributes transmitted via WISPr

If you enable WISPr and you use an external RADIUS server, the Public Spot transmits the attributes (access request):

- **Location ID**
- **Location name**
- **Logoff URL**

These attributes are subset of the values configured in the previous section. The provider or roaming broker can use them to identify the location of the client for accounting purposes. Vendor Specific Attributes (VSA) are used with the IANA Private Enterprise Number (PEN) 14122.

The Public Spot processes the attributes (access accept) from an external RADIUS server:

- **Redirection URL:** URL to which a client should be redirected after login. This function is not supported by all smart clients.
- **Bandwidth max up:** Maximum uplink bandwidth available to the client.
- **Bandwidth max down:** Maximum downlink bandwidth available to the client.
- **Session terminate time:** Time when the client should be automatically de-authenticated. According to ISO 8601, the format is `YYYY-MM-DDThh:mm:ssTZD`. If "TZD" is not entered, the client is de-authenticated according to the local time on the Public Spot.
- **Session terminate end of day:** The value of this attribute can be either 0 or 1. It indicates whether the client is de-authenticated on the Public Spot at the end of the accounting day.

For accounting purposes, the Public Spot uses the following attributes:

- **Location ID**
- **Location name**

## 14.5.3 Expert settings for the PMS interface

In addition to the settings that LANconfig provides for the PMS interface, you have the possibility of configuring additional parameters in the setup menu. On one hand, these parameters encompass values that the device needs for internal synchronization with your PMS system, and that are normally not modified. On the other hand, you also find extended settings in the setup menu that you can use to increase the performance scope of the PMS interface, for example, by offering free access to an otherwise charged Public Spot access for your guests with VIP status.

The following pages offer you an overview of all parameters for the PMS interface that are not configured over LANconfig.

## Accounting

In this menu you configure the transfer of accounting information from your device to your PMS.

**SNMP ID:**

2.64.10

**Telnet path:****Setup > PMS-Interface**

### Clean-up accounting table period

Using this entry you configure the interval that the device uses to clean up expired sessions from the internal accounting table in the status menu. If the value is 0, automatic clean-up is disabled.

**SNMP ID:**

2.64.10.3

**Telnet path:****Setup > PMS-Interface > Accounting****Possible values:**

0 to 4294967295 seconds

**Default:**

60

### Save to flash ROM period

Using this entry you configure the interval that the device uses to store collected accounting information to the internal flash ROM.



Please note that frequent writing operations to this memory will reduce the lifetime of your device.

**SNMP ID:**

2.64.10.2

**Telnet path:****Setup > PMS-Interface > Accounting****Possible values:**

0 to 4294967295 seconds

**Default:**

15

### Update accounting table period

Using this entry you configure the interval that the device uses to update the internal accounting table in the status menu. If the value is 0, the update is disabled and the status table does not display any values.

**SNMP ID:**

2.64.10.4

**Telnet path:****Setup > PMS-Interface > Accounting****Possible values:**

0 to 4294967295 seconds



**Default:**

15

**Login form**

In this menu you make specific settings for the PMS for the login/portal pages which are displayed to your guests in case of unauthorized access attempts on the hotspot.

**SNMP ID:**

2.64.11

**Telnet path:****Setup > PMS-Interface****Free VIP status**

In this table, you locally manage the VIP categories from your PMS.

**SNMP ID:**

2.64.11.6

**Telnet path:****Setup > PMS-Interface > Login-Form****Status**

Enter the VIP category from your PMS for the members that you want to provide with free Internet access.

For example, if you set up three VIP statuses (VIP1, VIP2, VIP3) for your PMS server, but you only want to offer hotel guests in category VIP2 free Internet access, enter the corresponding ID here.

**SNMP ID:**

2.64.11.6.1

**Telnet path:****Setup > PMS-Interface > Login-Form > Free-Of-Charge-VIP-Status****Possible values:**

String, max. 20 characters

**Default:****Fidelio free additional check**

Select the additional ID that a hotel guest uses – in addition to their username and room number – to authenticate on the Public Spot if you offer free Internet access. If you select `No-Check`, the device does not check for an additional ID.

**SNMP ID:**

2.64.11.3

**Telnet path:****Setup > PMS-Interface > Login-Form****Possible values:**

none

Reservation number

Arrival date

Departure date

First name

Profile number

**Default:**

none

**Fidelio free VIP additional check**

Select the additional ID used by a VIP – in addition to their username and room number – to authenticate on the Public Spot if you offer your VIPs free Internet access. If you select `No-Check`, the device does not check for an additional ID.

**SNMP ID:**

2.64.11.5

**Telnet path:**

**Setup > PMS-Interface > Login-Form**

**Possible values:**

none

Reservation number

Arrival date

Departure date

First name

Profile number

**Default:**

none

**Fidelio charge additional check**

Select the additional ID used by a hotel guest – in addition to their username and room number – to authenticate on the Public Spot if you offer fee-based Internet access. If you select `No-Check`, the device does not check for an additional ID.

**SNMP ID:**

2.64.11.4

**Telnet path:**

**Setup > PMS-Interface > Login-Form**

**Possible values:**

none

Reservation number

Arrival date

Departure date

First name

Profile number

**Default:**

Reservation number

### PMS login form

Choose the login page to be displayed by the portal page for your PMS interface.

**SNMP ID:**

2.64.11.2

**Telnet path:**

**Setup > PMS-Interface > Login-Form**

**Possible values:**

- `Free-of-charge`: Choose this option if you offer your hotel guests free Internet access. Your hotel guests will still be required to authenticate on the hotspot on the portal page with their username, room number and, if required, an additional ID in order to prevent access to the Internet by unauthorized users.
- `Subject to charge`: Choose this option if you offer your hotel guests fee-based Internet access. Your hotel guests will be required to authenticate on the hotspot on the portal page with their username, room number and select a tariff.
- `free-VIP`: Select this setting, if you want to offer your otherwise fee-based Internet access free of charge to VIPs. Although your VIPs see the login screen for fee-based access, they will not be billed any fees.

**Default:**

Free-of-charge

### PublicSpot login form

Enable or disable whether the portal page displays the Public Spot's own login screen. If you disable this setting, Public Spot users that use a combination of username and password as credentials (e.g., predefined or users with vouchers) can no longer login to the device.

**SNMP ID:**

2.64.11.1

**Telnet path:**

**Setup > PMS-Interface > Login-Form**

**Possible values:**

No

Yes

**Default:**

No

### Guest name case sensitive

Enable or disable whether the device checks the last name for capitalization (case sensitively) against the name of the guest in the PMS database during login. If this setting is enabled, the guest's Public Spot access is rejected if the spelling and capitalization of his name does not match that transferred by the hotel.

**SNMP ID:**

2.64.12

**Telnet path:**

**Setup > PMS-Interface**

**Possible values:**

No

Yes

**Default:**

Yes

**Separator**

Using this entry you configure the separator that your PMS uses to transfer data records to an API. The Micros Fidelio specification, e.g., uses the pipe symbol by default (|, hex 7C).



You should not change this value if at all possible. An incorrect separator can lead to your PMS being unable to read the transmitted data records, and the PMS interface not working!

**SNMP ID:**

2.64.6

**Telnet path:****Setup > PMS-Interface****Possible values:**

String, max. 1 characters

**Default:**

|

**Character set**

Choose the character used by the PMS to transmit your guests' surnames to the device.

**SNMP ID:**

2.64.7

**Telnet path:****Setup > PMS-Interface****Possible values:**

CP850

W1252

**Default:**

CP850

## 15 Voice over IP (VoIP)

### 15.1 Introduction



The term Voice over IP (VoIP) refers to voice communications over computer networks based on the Internet protocol (IP). The core idea is to provide the functions of traditional telephony via cost-effective and wide-spread networking structures such as the Internet. VoIP itself is not a standard, rather it is a collective term for the various technologies (equipment, protocols, voice encoding, etc.) which make voice communications in IP networks possible.

Different terminology is used for telephony over a network (LAN or Internet) The terms "Voice over IP" or "IP telephony" are used as synonyms, although in actual fact they have different meanings.

- Strictly speaking, "Voice over IP" is merely a term for the technology of transmitting calls across data networks in real-time using the IP protocol (Internet protocol). The term is also used when the technology is implemented only in the provider's core networks, in what is known as the backbone
- The term "IP telephony" is used when the VoIP technology is also used in the terminal equipment, so that the call subscriber uses the IP network for telephony.
- "Internet telephony" is also used to describe telephony using VoIP over the Internet in general.

In the following, "Voice over IP" is usually used even to refer to IP telephony in accordance with general custom.

There are four basic types of terminal equipment that can be used for VoIP telephony:

- With software running on the PC, known as a "softphone".
- With an IP or VoIP telephone that is connected directly to the local network.
- With a conventional telephone that is connected to the local network by an adapter (analog telephone adapter, ATA).
- Via a VoIP gateway that converts telephone calls from telephones (analog and ISDN) to VoIP and can then communicate between the two "telephone worlds" like a PBX.

There is a basic difference between a VoIP connection being established between two pieces of terminal equipment that are connected directly to the data network (PC or IP telephone) and the situation where a subscriber in the land-line or mobile telephone network requires the conversion of the signaling, numbers and voice data. To differentiate the various connection variants, a device in the LAN has become known as a "PC", and a device in the land-line network has become known as a "phone".

#### 15.1.1 PC-to-PC communication

With this application, the terminal equipment has to be integrated directly into the user's LAN. Examples are a PC, an IP telephone or a telephone that is connected to the LAN using an ATA.

Different software solutions are available for the PC, known as "softphones". Note that some of these programs can only communicate with users of the same software and not with softphones from other manufacturers. Communication is usually free of charge within the Internet. A current example is Skype, which uses its own protocol.

#### 15.1.2 PC-to-phone and phone-to-PC communication

In this case, the call data has to be transmitted from the Internet to the landline network, usually using what are known as VoIP gateways. In general, these gateways are provided by providers and are subject to a fee.

VoIP routers offer another option that can switch VoIP calls to an ISDN line. Examples are different LANCOM VoIP Router types with an SIP gateway and ISDN interfaces. When the calls are transferred to the landline network, the usual telephone operator fees are charged.

So that the subscriber can even be called on a PC, he or she needs a VoIP telephone number that is usually provided by a provider.

VoIP providers usually only provide individual numbers and not complete number ranges with a switchboard number and extension numbers. This is why the numbers that are provided by public providers are not attractive to many business customers. When the LANCOM VoIP Router is used with a SIP gateway, previously-used numbers can be maintained; the functions of VoIP telephony can also be used.

## 15.2 VoIP implementation in the LANCOM VoIP Router

The main task of the VoIP implementation in the LANCOM VoIP Router is to connect telephone calls from different local interfaces (LAN, WLAN, ISDN) to the WAN connections that can be accessed by the router. This enables switching between the local interfaces (local call) as well as between WAN interfaces.

The basis for the implementation and switching is the SIP protocol. The calls over all interfaces are converted into SIP by the interface converter (this mainly concerns the ISDN interfaces). The ISDN-ISDN bridge function is a special case that is activated when ISDN protocols cannot be mapped in SIP, which is why a bit-transparent connection is created between an ISDN-TE (external ISDN connection) and an ISDN-NT (internal ISDN connection).

Furthermore, the bit-transparent connection is usually used for calls between multiple local ISDN interfaces to achieve the highest possible compatibility and quality.

### 15.2.1 Example Applications

Voice over IP solutions offers advantages across a broad spectrum of applications, starting with small companies and extending to large corporations with extensive networks of subsidiaries. In the following section, we will demonstrate a number of examples.

 Detailed information about configuration is available in the chapter 'Configuration of VoIP functions'.

#### Supplementing existing ISDN PBXs

VoIP functions can be conveniently added in to existing telephone structures by using a LANCOM VoIP Router. The LANCOM VoIP Router is simply connected between the public ISDN connection (e.g. ISDN NTBA) and the ISDN PBX.

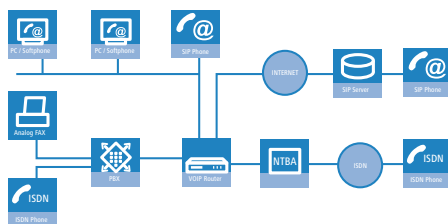

Telephone calls over the PBX and its ISDN telephones remain possible just as before; the telephones remain available under the familiar telephone numbers. This application additionally offers the following options:

- In addition to the ISDN telephones, VoIP telephones or VoIP softphones can be included in the telephone infrastructure. VoIP subscribers in the internal LAN are also able to call external ISDN subscribers.
- The ISDN telephones continue to function, and additionally they can call all of the internal VoIP telephones and softphones in the LAN.
- Calls to external SIP subscribers who use the same Internet provider are often available at no cost.

- With the appropriate connection to a public SIP provider, any other SIP subscriber worldwide can be called, irrespective of the provider network. As an alternative to a direct ISDN connection, ISDN network subscribers can also be reached over a diversion via the SIP provider. The costs depend on the provider's particular tariff models. Frequently, long-distance and overseas calls via an SIP provider are significantly cheaper than the traditional telephone connection.

In this constellation, the LANCOM VoIP Router takes over the switching of the calls. The device can be individually configured, for example, to use the access codes to decide upon the switching of a call either via the ISDN interface, or via the Internet as a VoIP call.

### Connecting subsidiaries or home offices to the headquarters

Many subsidiaries or home offices already have a connection to the network at headquarters over VPN. These connections are normally limited to conventional data transmission. By using VoIP, internal company calls can be made for free over the existing VPN connection and— thanks to the VPN encryption —these calls are secured against eavesdropping.

With a LANCOM VoIP Router located in the branch or home office, the two worlds of traditional and VoIP telephony can be united in a single telephone: A VoIP telephone or an existing ISDN telephone can be used for free telephone calls via VPN to the headquarters, or to make standard calls via ISDN.

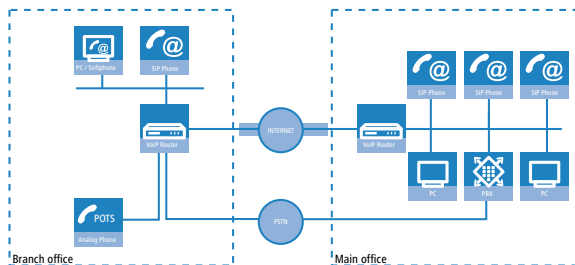

The advantages of a telephone connection to headquarters:

- The configuration of telephone functions can be carried out centrally in the VoIP PBX at headquarters.
- Subscribers at their branch or home offices connect with the central PBX.
- Calls within the company network are free.
- Outgoing calls are automatically directed to the optimal line for cost optimization.

### VoIP for companies through SIP trunking

One of the biggest hurdles for companies that fully migrate to VoIP is to maintain the existing telephone numbers. Normal provider SIP accounts come with a telephone number for the transition to the landline telephone network, but generally these numbers are selected from a pool of numbers available to the provider. However, for companies with a large number of telephone subscribers and numbers, it is of decisive importance that existing telephone and extension numbers are maintained after migrating to VoIP.

With the SIP trunking function, entire ranges of telephone numbers made up of external numbers and their associated extensions can be mapped by LANCOM VoIP Routers over a single connection to a SIP provider, assuming that the provider also supports Direct Dialing In (DDI) and can provide multiple connections simultaneously. Generally speaking, SIP providers that offer SIP trunking can acquire the existing telephone numbers from the former telecoms provider.

### Connecting local ISDN lines with a remote SIP gateway

Companies with nation-wide and internationally distributed sites are often interconnected with VPN already. A LANCOM VoIP Router can be used not only to connect the SIP and ISDN telephones at a branch office to the SIP-PBX at headquarters; it can also integrate local ISDN networks into corporate communications with help of the "SIP Gateway" function.

The SIP gateway is active for outgoing and incoming calls.

- A company headquarters in New York can, for example, use a LANCOM VoIP Router with SIP gateway located at the Los Angeles branch office to telephone with customers and suppliers located in Los Angeles at local rates ("local break-out").

- For improved availability to customers located abroad, the New York headquarters can, for example, use a LANCOM VoIP Router with SIP gateway located at their sales office in Italy. Customers can then reach support or service numbers via a standard national telephone number. Calls from the local ISDN network are received and directed within the company network to the responsible employee. Call routing can be used which identifies the customer's calling number and automatically selects the appropriate connection to be used for forwarding the call.

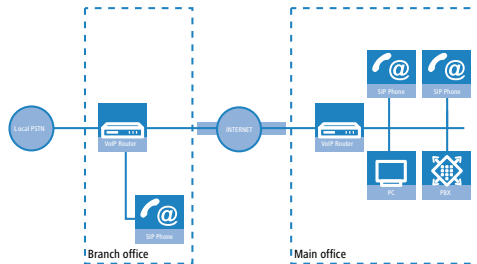

Advantages of the SIP gateway:

- The local ISDN connection at any site is available for use by any of the offices throughout the entire company.
- National and international long-distance calls can be mapped to local or regional calls, so saving costs.
- Automatic routing of incoming calls to the responsible employee.

### Connecting sites without a SIP PBX

Companies with widely disperse offices and without their own SIP PBX can also take advantage of VoIP site-to-site connectivity. In this "Peer-to-Peer" scenario, a LANCOM VoIP Router has been implemented at both locations.

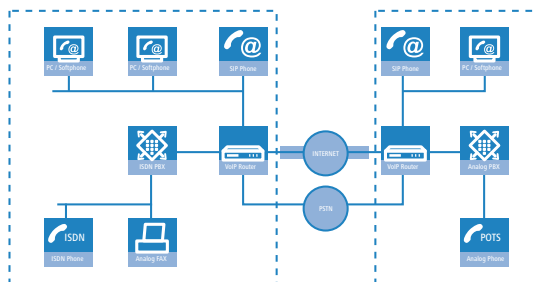

Along with data transfer via VPN, it is also possible to use VoIP functions between the two locations.

The advantages of peer-to-peer site-to-site connectivity

- ISDN PBXs at different locations can form a common internal telephone network.
- An SIP PBX is not necessary.
- Calls within the company network are at no charge.
- Outgoing calls are automatically directed to the optimal line for cost optimization.
- Incoming calls can be switched directly to the appropriate employee at a different location.

## 15.2.2 The central position of the LANCOM VoIP Router

LANCOM VoIP Router take up a central position in the switching of telephone calls between internal and external subscribers over the different channels of communication. Depending on the model and equipment, the devices interconnect the following communication participants and channels into a common telephone infrastructure.

- Internal VoIP terminal devices connected to LAN, WLAN and DMZ, such as SIP telephones and SIP softphones
- The internal ISDN infrastructure with ISDN PBX and ISDN telephones
- Analog terminal devices, internally connected either into the ISDN network via a PBX with a/b ports, or alternatively into the VoIP network over an ATA (Analog Telephone Adapter).
- External SIP providers and all of the external subscribers attainable via them
- Upstream SIP PBXs with all of the internal and external subscribers attainable through it



6. The external ISDN world via ISDN NTBA or upstream ISDN PBX, and all of the external subscribers available via the land-line network

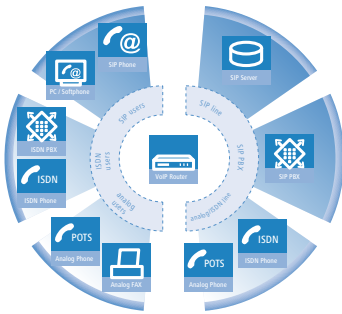

## Users and lines

Telephony subscribers in internal areas can take part in voice communications and, in the LANCOM VoIP environment, are referred to as "users". The LANCOM differentiates between:

- ISDN users

Devices connected over the ISDN network, including ISDN and analog devices connected to an upstream ISDN PBX.

When connecting downstream PBXs to point-to-point lines, the number of possible ISDN subscribers is determined by the length of the extension number (DDI). In this case, all of the telephones and terminal equipment connected to the PBX can be mapped with a single ISDN user entry.

- SIP users

SIP terminal devices connected over LAN, WLAN and DMZ and analog devices connected with an ATA.

The external paths of communication available to the users are known as "lines". The LANCOM differentiates between the following lines:

- ISDN

A connection to an ISDN NTBA over the TE interface. The NT interface can additionally be used to connect ISDN terminal devices directly or via a downstream ISDN PBX.

- SIP lines

There are three different types of SIP line:

- A "Single account" line acts like a normal SIP account with a single telephone number. The internal users can all make use this account for making SIP calls, although only one call can be conducted at a time.

Depending on the provider services, these lines can be used to reach subscribers in the provider networks, subscribers in other SIP networks (partner networks), or even land-line subscribers. Your own availability at your own telephone number or even solely with an SIP name over the Internet also differs from provider to provider.

- A "trunk" line acts like an extended SIP account with a main external telephone number and multiple extension numbers. Internal users use this account in parallel and several calls can be made simultaneously (until the maximum available bandwidth is exhausted).
- As a "SIP gateway" line, the LANCOM VoIP Router provides a remote SIP PBX with a transition to the local ISDN network. The SIP gateway is registered at the SIP PBX with a single number, although several calls can be conducted at once (until the maximum available bandwidth is exhausted). The connection between the SIP PBX and the LANCOM VoIP Router is normally established over a VPN connection.

- SIP PBXs

Connections to upstream SIP PBXs. These lines are generally connections to large PBXs in the network at headquarters which can be reached via a VPN connection.

---

 The precise number of users and lines available varies between models and software options.

## 15.3 Call switching: Call routing

All calls between internal subscribers and subscribers who can be reached over external lines are handled as SIP calls by the LANCOM—even if the connection is between two ISDN subscribers.

The call router in the LANCOM VoIP Router switches the call. The switching relies mainly on the information in two tables:

- For telephone numbers arriving at the call router, rules in the call-routing table are able to alter these numbers if needed and can decide which line to use for a call.
- The table for the locally registered user provides information about which terminal device is available at which internal telephone number.

The bandwidth reservation, QoS settings and firewall settings that are necessary for reliable transmission of voice data are carried out automatically by the LANCOM.

- When establishing a connection, the LANCOM checks (under consideration of the permitted codecs) which **maximum** bandwidth will potentially be required.
  - This bandwidth is then automatically reserved by the QoS module upon initiation of the connection.
  - If negotiation shows that the maximum bandwidth is not available, the connection will not be made.
  - If negotiations between the terminal devices can agree upon a codec with lower bandwidth requirements, then the reserved bandwidth will be lowered accordingly.
- All packets from ISDN users are given a DiffServ marking by the LANCOM (with SIP users, the QoS marking is usually handled by the telephones or softphones).
  - SIP packets for signaling are marked as CS1.
  - RTP packets are marked as EF.

The ports required for the transmissions are activated automatically.

### 15.3.1 SIP proxy and SIP gateway

The tasks involved in switching calls between the different lines of SIP and ISDN subscribers are handled by two functions in the LANCOM VoIP Router.

- SIP proxy

A SIP proxy handles the switching between callers.

- SIP gateway

The SIP gateway handles the conversion between IP-based telephony that uses the SIP protocol and other (telephone) networks, for example the ISDN network.

### 15.3.2 User registration at the SIP proxy

A LANCOM VoIP Router represents the central exchange for SIP calls between different subscribers who wish to communicate over different types of line. The task of switching in the LANCOM are handled by the SIP proxy. A telephone signals the SIP proxy that it needs to establish a connection, and the SIP proxy uses certain rules to decide which line is

to be used for the connection. Conversely, incoming calls are assigned to a certain terminal device by the SIP proxy according to its rules.

For terminal devices to be able to take part in this switching, they must be registered with the SIP proxy. Where the registration is limited to call switching by the LANCOM, we refer to "local registration".

If other exchanges are involved, e.g. an SIP PBX at another location, then we refer to an upstream registration. In this case, the LANCOM accepts the request for registration and forwards it upstream. In this instance, the LANCOM is described as "transparent proxy".

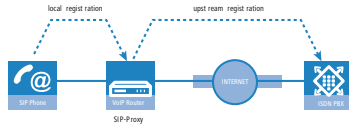

The great advantage with this two-stage registration comes to bear in the backup event: If the connection to an upstream SIP PBX is not available, the SIP proxy can handle the user who is registered upstream as a local user and can then direct the calls over alternative lines.

### Registration at the LANCOM VoIP Router (local registration)

For local registration at the LANCOM, it is initially sufficient for the user to send a valid VoIP domain to the SIP proxy. The internal VoIP domains of the LANCOM VoIP Router are valid, as are all domains entered in a SIP line.

- For SIP terminal devices in the LAN (SIP telephone or SIP softphone), the domain is entered in the configuration. There is no need for an entry as a SIP user in the configuration of the LANCOM. This variant is known as "automatic registration".
- The domain cannot be entered into ISDN terminal equipment; instead, ISDN users have to be registered in the LANCOM configuration with a corresponding entry as an ISDN user .
- To prevent unknown subscribers from registering, authentication at the SIP proxy can be set as a prerequisite to local registration (local authentication). In this case, an entry as a SIP or ISDN user in the LANCOM configuration is essential.



Automatic registration without entering a password is restricted to the SIP users in the LAN. SIP users in the WAN require an appropriate user entry and authentication by password.

### Registration at an upstream SIP PBX (upstream registration)

Generally, authentication by user and password is always required for registration at a SIP PBX. There are two possible ways of transmitting the authentication data to the SIP PBX:

- All SIP and ISDN users at the LANCOM VoIP Router end use the same shared access information. In this case, only the VoIP domain for the SIP PBX and the appropriate user ID are entered into the SIP terminal device. For ISDN users, the VoIP domain of the SIP PBX is entered into the LANCOM as an ISDN user. The SIP proxy recognizes the request for registration at the upstream SIP PBX if the domain communicated from the client agrees with a domain entered into the SIP PBX line. The proxy then forwards the registration data together with the shared password to the SIP PBX.

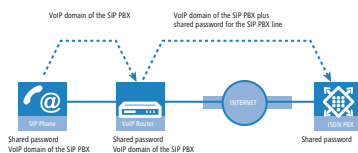

- If SIP or ISDN users at the LANCOM VoIP Router are entered into the SIP PBX with different passwords, then the users have to enter their individual passwords upon registration. Consequently, each SIP or ISDN user has an entry

into the LANCOM with the individual passwords, which are also entered into the SIP terminal devices. Users with shared and individual passwords can be managed in parallel.

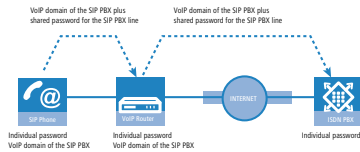

## Particular aspects for ISDN users

Integrating ISDN terminal equipment into the LANCOM VoIP environment and the necessary steps for configuration depend upon the application at hand and, if applicable, upon the options available with a PBX. The main questions to be answered by the user are as follows:

- Can ISDN terminal devices telephone internally with SIP users?
- Are ISDN terminal devices available externally over SIP lines?
- Can ISDN terminal devices telephone externally over SIP lines?

To answer these questions, we differentiate between the following constellations:

- If ISDN terminal equipment can be reached over an ISDN TE interface on the LANCOM, it is described as "upstream". From the perspective of the LANCOM, the ISDN terminal devices are on an external line. This ISDN terminal equipment is normally not classified as being for local users, and so no entries for ISDN users are necessary.

ISDN terminal equipment at an upstream ISDN PBX...

- can make internal calls to SIP users if the corresponding telephone numbers are configured as internal MSNs in the ISDN PBX.
- can receive internal calls from SIP users if the internal MSNs of the ISDN equipment are output to the ISDN line by the call-routing table, for example over a standard route.
- can only make calls over SIP lines if the PBX is able to output certain call numbers over its internal ISDN bus. Otherwise, all calls not matching with its internal MSNs would be forwarded by the ISDN PBX to the public telephone network.
- can only receive calls from an upstream SIP PBX if entered into the LANCOM as an ISDN user and registered as such with the SIP PBX.
- If ISDN terminal equipment can be reached over an ISDN NT interface on the LANCOM, it is described as "downstream". For the LANCOM, this is then a local subscriber that can be reached via the list of registered users. As ISDN terminal equipment cannot send domain information to register at the LANCOM, it must be entered as an ISDN user so that it can be recognized by the VoIP system.

ISDN terminal equipment at a downstream ISDN PBX...

- can make internal calls to SIP users by entering the character for an outside line as required by the PBX and then dialing the SIP user's internal number. The PBX then forwards the call to the SIP user's internal number—without the outside-line access code—over its external ISDN bus to the LANCOM.
- can receive internal calls from SIP users as long as the entry for the ISDN user contains the correct allocation of the internal number to the appropriate MSN. The LANCOM takes a call to the ISDN user's internal number, translates it to the MSN, and outputs it to the allocated ISDN bus. The PBX receives the MSN as if it were an external call and forwards it to the corresponding ISDN terminal equipment.
- can conduct incoming and outgoing calls over SIP and ISDN just like SIP users. Again, the outside-line code may be necessary for outgoing calls.

## Dynamic ISDN users at point-to-point connections

When connecting downstream PBXs to a point-to-point interface of the LANCOM VoIP Router, the number of possible ISDN terminal devices is only limited by the length of the extension number. With three-figure extension numbers, almost 1000 terminal devices can be connected, all of which can be managed as ISDN users in the LANCOM VoIP Router.

Through an ISDN user entry with a # character as a placeholder for the telephone numbers, all ISDN terminal devices with their respective extension numbers can be set up as dynamic ISDN users.

! User entries that use # characters to map user groups cannot be used for registration at an upstream PBX. This registration always demands a specific entry for the individual ISDN user.

### 15.3.3 Number translation at network transitions

LANCOM VoIP Router switch calls between different telephone networks, e.g. the ISDN network, various SIP provider networks, and the internal telephone network. These networks generally have different ranges of numbers or even completely different conventions for addressing subscribers. Whereas the traditional land-line network uses numerical characters with country code and area access codes, the world of SIP allows alphanumerical names along with domain information.

The transition between these zones must guarantee the correct translation of "telephone numbers" so that the intended subscriber can be reached. For example, when a call from the land-line network arrives at a public MSN, the requested telephone number has to be translated to the ISDN user's internal number. This act of translation is known as "mapping". Mapping incorporates not only the **called** number, which represents the destination, but the **calling** number for the source as well.

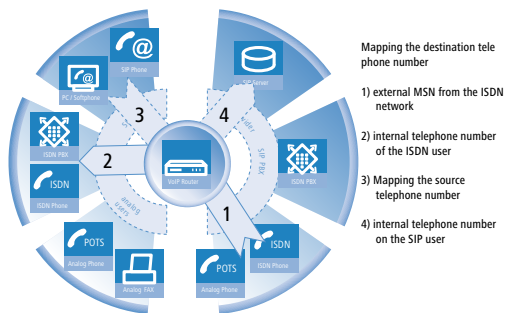

Depending on the application at hand, both the called and the calling numbers have to be modified so that a return call can be made to the source number.

Call number translation at the transition to outside lines is primarily implemented by mapping entries in the ISDN and SIP lines and by rules in the call-routing table.

### 15.3.4 The Call Manager

The Call Manager has the central task of allocating the calls waiting to be switched to a certain line or to a certain user. The Call Manager makes this allocation by using the call-routing table and the list of registered users. The calls are switched in the following steps:

- Processing of called numbers (Calling Party ID)

First of all there is a check to see whether a numeric or alphanumeric number is available. Typical dialing separators such as "()-/" and <blank> are removed. A leading "+" is left in place. In this case, the number is still treated as a numeric number. If the check reveals any other alphanumerical character, the number is treated as alphanumeric and remains unchanged.

- Resolving the call in the call routing table

After processing the Called Party ID, the call is passed over to the call-routing table. Entries in the call-routing table consist of sets of conditions and instructions. The entries—with the exception of the default routes—are searched through and the first one that satisfies **all** of the conditions is executed.

- Resolution of the call with tables of local subscribers

If no entry is found in the call-routing table, then the Call Manager searches through the list of local subscribers. Call routing considers all of the users known to the call router (registered SIP users, configured ISDN users). If an entry is found that agrees with the called number and that has the matching destination domain, then the call is delivered to the corresponding subscriber.

If there is no local subscriber with matching number and destination domain, then the following cycle searches for an agreement between the number of the local subscriber and the called number; the destination domain is ignored.

- Resolution of the call with default entries in the call-routing table

If the preceding cycles referring to the call-routing table and lists of local subscribers remain unsuccessful, then the waiting call is checked once again with the call-routing table. This pass only takes the default routes into account, however. The numbers and destination domains entered into the default routes are ignored. Only the source filters are processed, assuming that the default routes has these filters.

---

 Specific examples of call-routing procedures can be found in the configuration examples described.

### 15.3.5 Making telephone calls with the LANCOM VoIP Router

Using the LANCOM VoIP Router opens up a variety of new possibilities for making telephone calls. Depending on the constellation of terminal equipment implemented (e.g. SIP or ISDN telephones, SIP or ISDN PBX systems) and, depending on the configuration for call routing in the LANCOM VoIP Router, certain information is critical for understanding the establishment of connections.

#### Automatic outside line access

Using the LANCOM VoIP Router and the enhancement with VoIP functionality within your telephone structure is designed to support the users' telephone behavior with the greatest possible convenience. One of the core aspects of this is the use of "spontaneous" or "automatic" outside line access, a feature that is familiar to users of standard PBX systems.

- Most PBX systems are configured in such a way that the telephone subscribers must dial a "0" before the desired telephone number in order to gain access to an outside line - that is, to carry out a telephone conversation via a public telephone network.

Without the "0" prefix, the number dialed is considered to be an internal number from another extension line on the private PBX.

- If "automatic outside line access" is set up, all numbers dialed are directed over the public telephone network. In this case, internal telephone calls to other extensions are not possible or only possible when a special symbol is dialed before the number.

When the telephone structure is extended with a LANCOM VoIP Router, a variety of new possibilities become available for connecting telephone terminal equipment. This includes the existing analog or ISDN telephones (where necessary, connected to the respective PBX) or VoIP terminal equipment such as SIP telephones or PCs with VoIP software.

As a new and central building block in the telephone structure, the LANCOM VoIP Router assumes many of the PBX tasks for connected terminal equipment. As such, you can also set up the automatic outside line access for the terminal equipment connected to the LANCOM VoIP Router directly for the ISDN or SIP subscriber groups, thereby adapting it to existing telephone behavior.

- When automatic outside line access is turned off, subscribers must dial a "0" before the desired number in order to carry out a telephone conversation via a public telephone network.

All calls without a "0" preceding the number will be treated as calls to internal extensions within the private telephone network.

- If automatic outside line access is turned on, all numbers dialed will be directed over a public telephone network.

For telephone calls to internal extensions, a special symbol or a specific number combination must be dialed before the number. With the standard settings, when automatic outside line access is enabled, a star \* is activated as the identification symbol for an internal number. This setting can be adjusted to match the character that you are familiar with.

! If you operate the LANCOM VoIP Router on the extension line of a PBX, it is recommended that outside line access for the router be configured in the same way as for the PBX so that the behavior remains the same from the user's perspective.

- Example of a downstream PBX

A LANCOM VoIP Router is switched between the ISDN outside line and the existing ISDN PBX. In the PBX, automatic outside line access is enabled, the call router settings for the LANCOM VoIP Router decide whether or not a "0" must be dialed for outside line access for the connected ISDN and SIP subscribers.

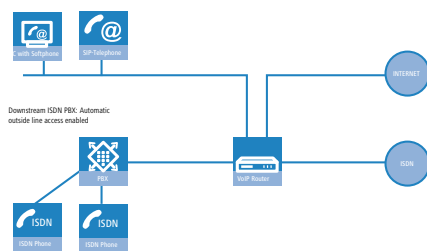

! If the LANCOM VoIP Router in this constellation is not available, for example, due to a power outage, the ISDN connection for the downstream ISDN PBX is automatically "bridged" to the external ISDN connection (when life-line support is enabled). For a LANCOM VoIP Router **without** automatic outside line access, the ISDN subscribers should not dial a "0" before the number while the life-line support is active.

- Example of an upstream PBX

A LANCOM VoIP Router is connected to an ISDN PBX extension line. In the LANCOM VoIP Router, automatic outside line access is enabled, the settings for the upstream PBX decide whether or not a "0" must be dialed for outside line access for the connected ISDN and SIP subscribers.

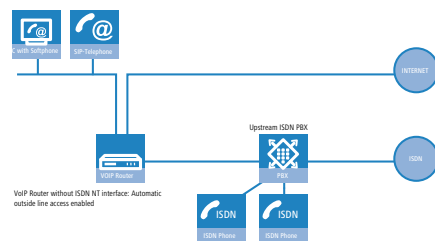

## Dialing various numbering areas

When dialing other parties, the following numbering areas are available for use:

- Internal numbers are comparable to the extension line numbers for traditional PBX systems ("extension"). Subscribers can reach each other directly using these internal numbers without having to go through a public telephone network.

The internal numbers must be unique for all subscribers within the private telephone network, this also includes any other PBX systems that may be connected!

The internal subscribers can be reached by simply dialing the internal number without a "0" preceding it.

! Depending on the settings for automatic outside line access, a special preceding dialing signal may be required.

- Via **local telephone numbers** you can reach external parties who are in the same local telephone network as the LANCOM VoIP Router, i.e. users with the same area code as the public line for the LANCOM VoIP Router.

In decentralized locations that extend beyond city or state boundaries, the physical location of the device is decisive, even if a central PBX is located at a different location. Therefore, for a LANCOM VoIP Router in London, all telephone subscribers in the local telephone network for London can be reached using local numbers, even if a SIP PBX connected via VPN can be reached in Manchester.

 Depending on the settings for automatic outside line access, a "0" prefix may be required.

- The **national and international numbers** behave in the same way as local numbers; here, the physical location of the devices is decisive for the assignment of corresponding access codes. Therefore, a LANCOM VoIP Router in Austria belongs to the national telephone network in Austria, even if there is a VPN connection to the SIP PBX at the headquarters in Germany.

 Depending on the settings for automatic outside line access, a "0" prefix may be required.

### Special numbers

Certain special numbers (emergency numbers, toll-free or particularly expensive service numbers) can be subjected to special treatment by the call router.

- For example, this ensures that emergency numbers for the police or fire department are always secured, even if the subscribers do not dial the correct preceding dialing signal for outside line access.

With the standard settings, the emergency numbers "110" and "112" are configured in such a way that they can be dialed correctly with or without the preceding "0".

- For toll-free numbers such as "0800", a direct connection via ISDN is usually selected in order to use the toll-free land-line to land-line connection.

### Dialing using specific lines

With the LANCOM VoIP Router, other lines, in addition to the previously existing ISDN exchange lines, can be defined for voice communication, i.e. to a SIP PBX connected via VPN or to a public SIP provider via the Internet. Each time a connection is established, the call router decides which of the existing lines is to be used for the call based on pre-determined rules.

As an alternative to the automatic selection by the call router, you can direct individual calls to a certain line, for example when you want to call a party purposely via ISDN and not via the SIP PBX at the headquarters. For this purpose, the call router assigns specific code numbers to existing lines, such as "98" for ISDN or "97" for a SIP provider. The targeted call via this line is then initiated with the corresponding identifier:

- The call with "020 123456" is assigned to a corresponding line by the call router, e.g. via the SIP PBX at the headquarters.
- However, the call with "98 020 123456" is made directly via the ISDN connection by the call router.

## 15.3.6 Call hold, transfer call, connect call

LANCOM VoIP Routers support various services which are familiar to users of the ISDN network:

- With **call hold** the user can place an active call into a wait state. In this state, the user can for example make a call to another person.
- With **transfer call**, the user can switch to and fro between two connections. The user is only connected with one caller at a time, while the other caller is put on hold.
- With **connect call** the user switches an active call over to another call which is on hold. The two callers are then connected and the user is no longer involved in the call.



The services call hold, transfer call and connect call are available to all local SIP, ISDN and analog users, and also to subscribers at an upstream SIP PBX; however, they can only be initiated by a SIP user.

### 15.3.7 Transfer of DTMF tones

ISDN telephone networks introduced the possibility of transmitting information on which button was pushed on the telephone using DTMF tones (Dual Tone Multiple Frequency). With the help of DTMF tones, the telephone user can communicate with voice mailboxes and computer telephony systems, for example.

In VoIP applications, special mechanisms are required to assume the DTMF tone function. If, for example, during a telephone call, a button is pressed on a VoIP telephone or a VoIP softphone, this should trigger the same action as a call with an ISDN telephone.

Generally, DTMF tones are transmitted in VoIP applications in one of two ways:

- In-band describes the transmission of the DTMF tones in the same data stream in which the voice data are transferred. However, this procedure is relatively unreliable because the DTMF tones in the IP datastream can easily be mistaken for voice data, particularly when using compression codecs.
- Out-of-band describes the transmission of the DTMF tones in a stream that runs parallel to the actual voice data. Two standards are generally used for out-of-band transmission:
  - SIP INFO (RFC 2976)
  - RC 2833 (RTP payload for DTMF digits)

Both variations can wrap information, e.g. on buttons pressed, their tone frequency and the length of time the button was pressed into the signaling datastream. In addition, events that should be transmitted with DTMF tones can also be transmitted in cleartext in the SIP data.

### DTMF signaling configuration

When configuring DTMF signaling, the type of transmission to be used for the DTMF tones must be set:

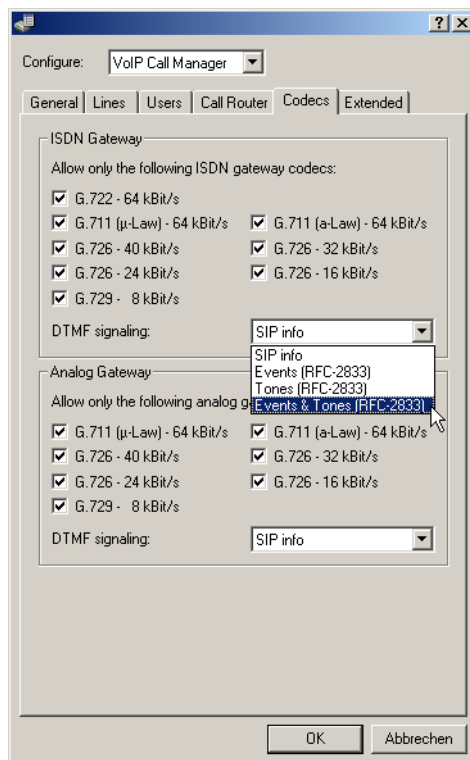

LANconfig: VoIP Call Manager / Extended

WEBconfig: LCOS menu tree / Setup / Voice Call Manager / General

### 15.3.8 Transfer toll information to the internal ISDN buses

LANCOM VoIP Routers support two variants of the AOC (Advice Of Charge) service:

- AOC-D refers to the transmission of charge information during the call.
- AOC-E refers to the transmission of charge information at the end of the call.

LANCOM VoIP Routers transmit charge information from both types of AOC service between internal and external buses. AOC-D charge information can be converted into a metering pulse for analog users at the internal analog interfaces if the corresponding option has been activated.

### 15.3.9 Supporting digital calls

LANCOM VoIP Routers support digital calls, e.g. when using Group 4 fax machines or when using ISDN terminal equipment for dialing in to particular networks. To direct these calls over an ISDN interface of the LANCOM VoIP Router, destination numbers can be given special prefixes.

## 15.4 Configuration of VoIP parameters

Changes with LCOS 7.6:

- Entry of the following parameter for SIP, ISDN and analog users:
  - CLIR
- Entry of the following parameters for SIP providers and SIP-PBX lines:
  - Local port number
  - (Re-) registration
  - Line monitoring
  - Monitoring interval
  - Trusted
  - Privacy method
- Entry of the following parameters for analog lines:
  - Caller-ID signaling
  - Caller-ID transmission requirements

## 15.4.1 General settings

LANconfig: VoIP Call Manager / General

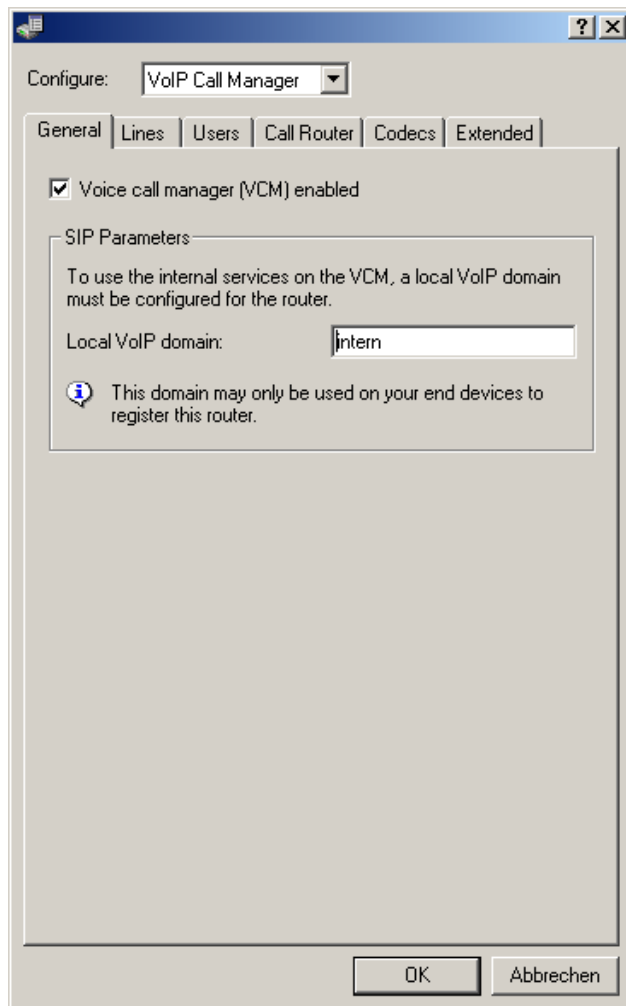

- **Voice Call Manager (VCM) activated**

Switches the Voice Call Manager between active / not active

- **Domain**

Name of the domain in which the connected telephones and the LANCOM Wireless Router are operated.

- Terminal devices working in the same domain register as local subscribers at the LANCOM Wireless Router and make use of the SIP proxy.
  - Terminal devices working with the other domain of an active SIP PBX line register themselves as subscribers at an upstream PBX.

- Create a SYSLOG message for each call

Each time a call is made with the LANCOM VoIP Router a SYSLOG message is created.

---

(!) Please note that to use this function, the appropriate SYSLOG settings have to be made.

- Send an e-mail for each call

Each time a call is made with the LANCOM VoIP Router an e-mail is sent to the defined address.

ⓘ Please note that to use this function, an SMTP account must have been set up.

## 15.4.2 Configuration of users

Local users are the terminal equipment/telephones that are connected to the LANCOM VoIP Router. There is a difference between:

- SIP users: Users who are connected to the LAN by means of a SIP telephone. For the user configuration, it does not matter whether the LAN is connected directly to LANCOM, or whether it is connected via a VPN (over the Internet).
- ISDN users: Users who are connected by ISDN. They use the SIP gateway to telephone using the VoIP function.
- Analog users: Users who are connected via analog interfaces. They use the SIP gateway to telephone using the VoIP function.

### General settings for all SIP users

LANconfig: VoIP Call Manager / Users

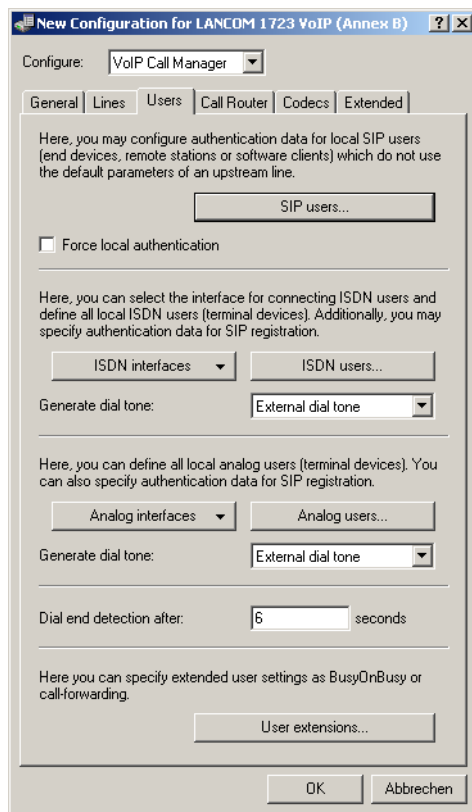

WEBconfig: LCOS menu tree / Setup / Voice Call Manager / General

- Force local authentication

The SIP proxy usually accepts a registration from all SIP users who register themselves with a valid domain. If local authentication is forced, only those subscribers who are saved in one of the user tables with relevant access information can register with the SIP proxy.

ⓘ Automatic registration without entering a password is restricted to the SIP users in the LAN. SIP users from the WAN as well as ISDN and analog users must always be authenticated by a user entry with password.

## SIP users

Depending on the model, different numbers of SIP users can be created. You cannot create more than the maximum number of users permitted; similarly, duplicate names or called numbers are not permitted.

 The domain that is used by the SIP subscriber is usually configured in the terminal equipment itself.

LANconfig: VoiP Call Manager / Users / SIP users

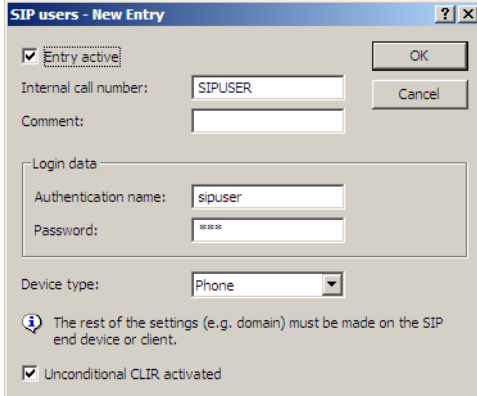

WEBconfig: LCOS menu tree / Setup / Voice Call Manager / Users / SIP users

The following parameters can be used to define a SIP user:

- **Number/Name**  
Telephone number of the SIP telephone or name of the user (SIP URI).
- **Auth-Name**  
Name for authentication at the SIP proxy, and also to any upstream SIP PBX when the user's domain is the same as the domain of a SIP PBX line. This name is required if registration is mandatory (e.g. when logging in to an upstream SIP PBX or when "Force local authentication" is set for local users).
- **Secret**  
Password for authentication to the SIP proxy, and also to any upstream SIP PBX, when the user's domain is the same as the domain of a SIP PBX line. It is possible for users to log in to the local SIP proxy without authentication ("Force local authentication" is deactivated for SIP users) and where applicable to an upstream SIP PBX using a shared password ("Standard password" on the SIP PBX line).
- **Device type**  
Type of device connected.
- **CLIR**  
Switches the transmission of the calling-line identifier on/off.
- **Active**  
Activates or deactivates the entry.
- **Comment**  
Comment on this entry

## General settings for all ISDN users

LANconfig: VoiP Call Manager / Users

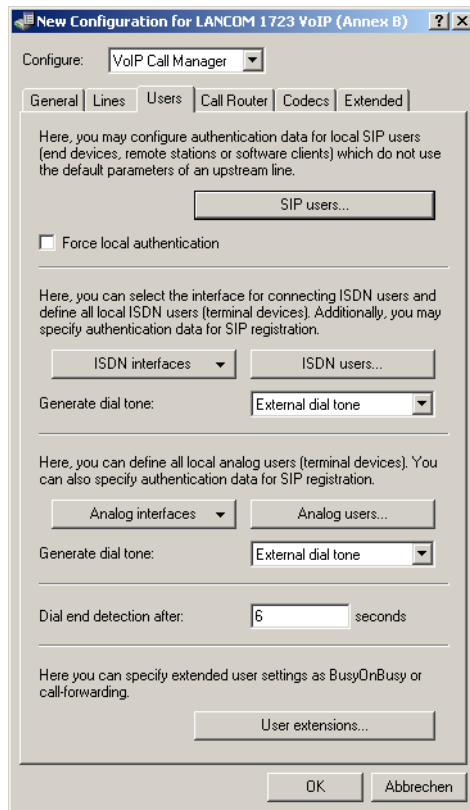

WEBconfig: LCOS menu tree / Setup / Voice Call Manager / General

### ■ Generate dial tone

The dial tone determines the noise an ISDN user hears after lifting up the receiver. The "internal dial tone" is the same as the tone that a user hears at a PBX without spontaneous outside-line access (three short tones followed by a pause). The "external dial tone" is thus the same as the tone that indicates an external line when the receiver is lifted (constant tone without any interruptions). If necessary, adapt the dial tone for the users with spontaneous outside-line access to simulate the behavior of a standard outside line.

## ISDN interfaces

For users who are connected by an ISDN line, the interface that is used is configured globally. An ISDN T interface (external) or even an ISDN TE interface (internal) can be configured. The latter is the case if users of an upstream PBX are to be managed as local users.

LANconfig: VoiP Call Manager / Users / ISDN interfaces

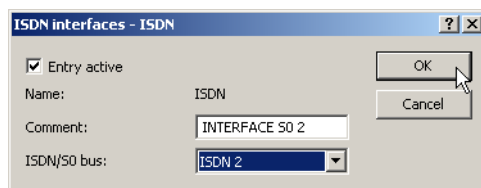

WEBconfig: LCOS menu tree / Setup / Voice Call Manager / Users / Interfaces

### ■ ISDN interface

Interface to which the ISDN subscribers are connected.

- **Entry active**

Interface is active / not active.

- **Comment**

Comment on the ISDN interface

## ISDN users

LANconfig: VoiP Call Manager / Users / ISDN users

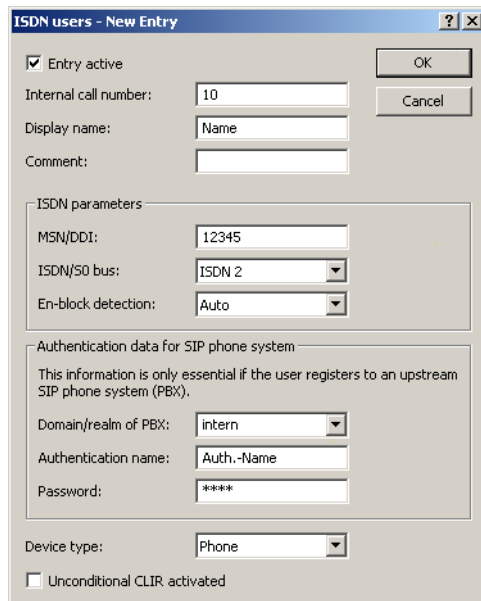

WEBconfig: LCOS menu tree / Setup / Voice Call Manager / Users / ISDN users

- **Number/Name**

Internal number of the ISDN telephone or name of the user (SIP URI).

! By using the # character as a placeholder, entire groups of numbers (e.g. when using extension numbers at a point-to-point connection) can be addressed via a single entry. With the number '#' and the DDI '#', for example, extension numbers can be converted into internal telephone numbers without making any changes. With the call number '3#' and the DDI '#', for example, an incoming call for extension '55' is forwarded to the internal number '355', and for outgoing calls from the internal number '377', the extension number '77' will be used.

! User entries that use # characters to map user groups cannot be used for registration at an upstream PBX. This registration always demands a specific entry for the individual ISDN user.

- **Ifc**

ISDN interface that should be used to establish the connection.

- **MSN/DDI**

Internal MSN that is used for this user on the internal ISDN bus.

- MSN: Number of the telephone connection if it is a point-to-multipoint connection.
- DDI (Direct Dialing in): Telephone extension number if the connection is configured as a point-to-point line.

---

 By using the # character as a placeholder, entire groups of call numbers, e.g. when using extension numbers, can be addressed via a single entry.

---

 User entries that use # characters to map user groups cannot be used for registration at an upstream PBX. This registration always demands a specific entry for the individual ISDN user.

- **Auth-Name**

Name for authentication at any upstream SIP PBX when the user's domain is the same as the domain of a SIP PBX line.

- **Display name**

Name for display on the telephone being called.

- **Secret**

Password for authentication as a SIP user at any upstream SIP PBX when the user's domain is the same as the domain of a SIP PBX line. It is possible for ISDN users to log in to an upstream SIP PBX using a shared password ("Standard password" on the SIP PBX line).

- **Domain**

Domain of an upstream SIP PBX when the ISDN user is to be logged in as a SIP user. The domain must be configured for a SIP PBX line in order for upstream login to be performed.

- **Device type**

Type of device connected.

- **DialCompl**

En-block dial detection.

- **CLIR**

Switches the transmission of the calling-line identifier on/off.

- **Active**

Activates or deactivates the entry.

- **Comment**

Comment on this entry.



## General settings for all analog users

LANconfig: VoiP Call Manager / Users

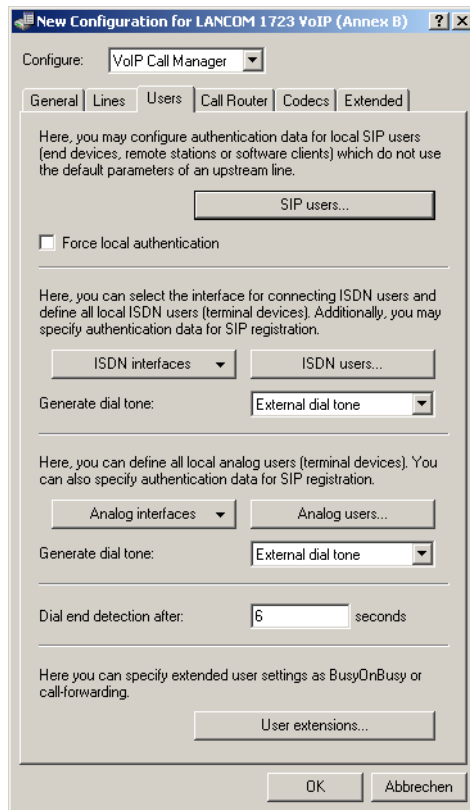

WEBconfig: LCOS menu tree / Setup / Voice Call Manager / General

### ■ Generate dial tone

The dial tone determines the noise an analog user hears after lifting up the receiver. The "internal dial tone" is the same as the tone that a user hears at a PBX without spontaneous outside-line access (three short tones followed by a pause). The "external dial tone" is thus the same as the tone that indicates an external line when the receiver is lifted (constant tone without any interruptions). If necessary, adapt the dial tone for the users with spontaneous outside-line access to simulate the behavior of a standard outside line.

## Analog interfaces

The internal analog interfaces (a/b ports) require configuration if they are to be used by local users (connection of terminal equipment).

LANconfig: VoiP Call Manager / Users / Analog interfaces

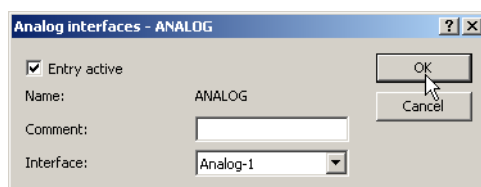

WEBconfig: LCOS menu tree / Setup / Voice Call Manager / Users / Interfaces

### ■ Interface

An internal interface to which the analog subscribers are connected.

- **Entry active**

Interface is active / not active.

- **Comment**

Comment about analog interface

Analog users

LANconfig: VoiP Call Manager / Users / Analog users

WEBconfig: LCOS menu tree / Setup / Voice Call Manager / Users / Analog users

- **Number/Name**

Internal number of the analog telephone or name of the user (SIP URI).

- **Auth-Name**

Name for authentication at any upstream SIP PBX when the user's domain is the same as the domain of a SIP PBX line.

- **Display name**

Name for display on the telephone being called.

- **Secret**

Password for authentication as a SIP user to any upstream SIP PBX when the analog user's domain is the same as the domain of a SIP PBX line. It is possible for ISDN users to log in to an upstream SIP PBX using a shared password ("Standard password" on the SIP PBX line).

- **Ifc**

Analog interface that should be used to establish the connection.

- **CLIR**

Switches the transmission of the calling-line identifier on/off.

- **Metering pulse**

The metering pulse is used in analog telephone networks to inform callers of the costs of their calls. With appropriate terminal equipment (e.g. telephone with charge display), the metering pulse is filtered out from the overall signal and this information is converted to display the call charge.

! This option allows the metering pulse to be passed on to the analog user/equipment. It is possible for charge information from the ISDN telephone network to be transferred to an ISDN line and converted into an analog metering pulse.

- **Domain**

Domain of an upstream SIP PBX when the analog user is to be logged in as a SIP user. The domain must be configured for a SIP PBX line in order for upstream login to be performed.

- **Device type**

Type of device connected.

! The type determines whether an analog connection should be converted into SIP T.38, where applicable. Selecting "Fax" or "Telephone/Fax" activates fax signal recognition that could result in an impairment of the connection quality for telephones. Therefore please select the corresponding type of device connected in order to ensure optimum quality.

- **Active**

Activates or deactivates the entry.

- **Comment**

Comment on this entry

## General settings for all SIP, ISDN and analog users

LANconfig: VoiP Call Manager / Users

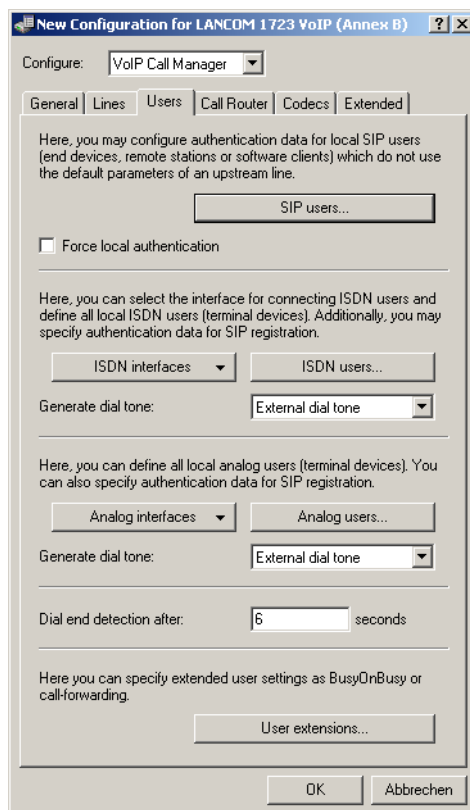

WEBconfig: LCOS menu tree / Setup / Voice Call Manager / General

- **Dial end detection after**

When dialing from an ISDN telephone, this time period is waited until the called number is considered as complete and sent to the call router.

Special values: With a dial delay of '0', a '#' has to be entered at the end of the called number. Entering the '#' character after the called number manually reduces the dial delay.

## User settings

The following parameters are available for configuring user settings in the LANCOM:

LANconfig: VoiP Call Manager / Users / User settings

WEBconfig: LCOS menu tree / Setup / Voice Call Manager / Users / Extensions

- Entry active

Activates or deactivates the entry.

- Internal telephone number

The call forwarding applies to this telephone number or SIP-ID.



Call forwarding can be set up for all local users (SIP, ISDN or analog).

- Enabling user control via keypad or DTMF

This activates or deactivates the option for users to configure their settings via the telephone.

- Busy on busy

Prevents a second call from being connected to a terminal device, irrespective of whether CW (call-waiting indication) is active on the device or not; i.e. there is no "call waiting" signal. The second caller hears an engaged tone. This also applies where an internal telephone number supports multiple logins and just one of the possible terminal devices is already in use.

- Call-forwarding unconditional (CFU)

Activates or deactivates the immediate forwarding of calls (CFU).

- to number

Target for immediate unconditional call forwarding

- Call-forwarding on busy (CFB)

Activates or deactivates call forwarding on busy.

- to number
  - Target for call forwarding on busy.
- Call forwarding, no reply (CFNR)
  - Activates or deactivates the delayed forwarding of call (after waiting for no reply).
- to number
  - Target for call forwarding no reply.
- Delay
  - Wait time for call forwarding on no reply. After this time period the call is forwarded to the target number if the subscriber does not pick up the phone.

### 15.4.3 Line configuration

#### SIP provider line

The device uses these lines to register with other SIP remote stations (usually SIP providers or remote gateways at SIP PBXs). The connection is made either over the Internet or a VPN tunnel.

LANconfig: VoIP Call Manager / Lines / SIP lines

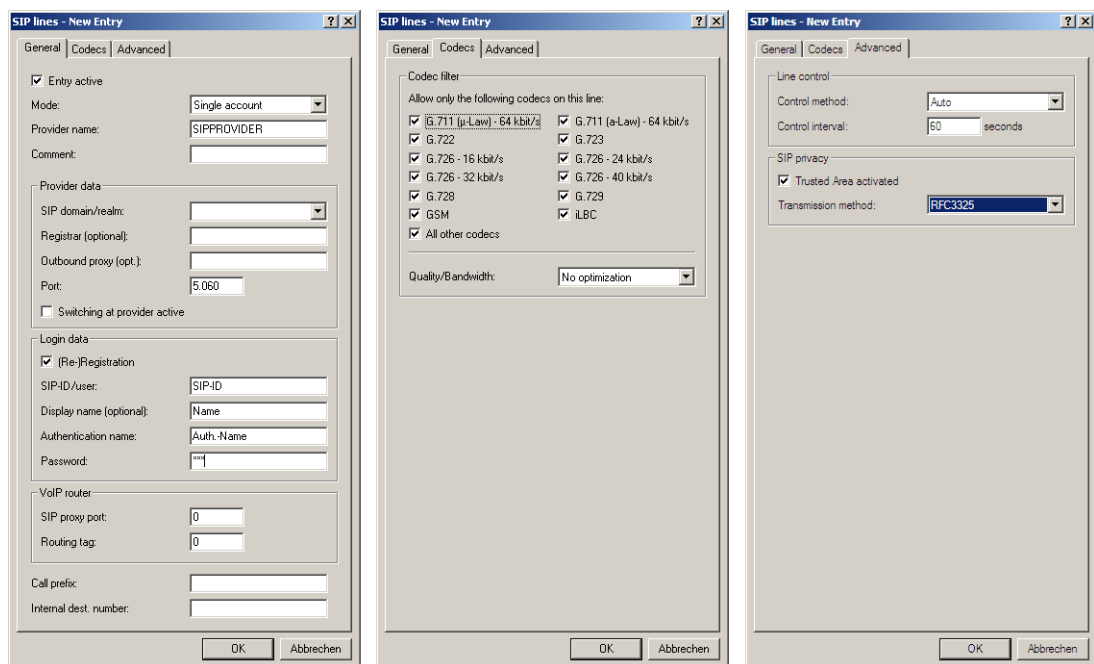

WEBconfig: LCOS menu tree / Setup / Voice Call Manager / Lines / SIP provider

- Name
  - Name of the line; may not be identical to another line that is configured in the device.
- Mode
  - This selection determines the operating mode of the SIP line.
  - Possible values:
    - Single account mode: Externally, the line behaves like a typical SIP account with a single public number. The number is registered with the service provider, the registration is refreshed at regular intervals (when (re-)registration has been activated for this SIP provider line). For outgoing calls, the calling-line number is replaced (masked) by the registered number. Incoming calls are sent to the configured internal target number. The maximum

## 15 Voice over IP (VoIP)

number of simultaneous connections is either set by the provider or it depends on the available bandwidth and the codecs being used.

Table for number translation:

Single account	SIP number incoming to the line	SIP number sent from the line
Outgoing call	"From:"	The number registered at the provider (User ID)
Incoming call	"To:"	User ID

- **Trunk mode:** Externally, the line acts like an extended SIP account with a main external telephone number and multiple extension numbers. The SIP ID is registered as the main external number with the service provider and the registration is refreshed at regular intervals (when (re-)registration has been activated for this SIP provider line). For outgoing calls, the switchboard number acts as a prefix placed in front of each calling number (sender; SIP: "From:"). For incoming calls, the prefix is removed from the target number (SIP: "To:"). The remaining digits are used as the internal extension number. In case of error (prefix not found, target equals prefix) the call is forwarded to the internal target number as configured. The maximum number of connections at any one time is limited only by the available bandwidth.

Table for number translation:

Trunk	SIP number incoming to the line	SIP number sent from the line
Outgoing call	"From:"	Switchboard number (User-ID) + "From:"
Incoming call	Switchboard number (User-ID) + "To:"	"To:" As internal extension

- **Gateway mode:** Externally the line behaves like a typical SIP account with a single public number, the SIP ID. The number (SIP ID) is registered with the service provider and the registration is refreshed at regular intervals (when (re-)registration has been activated for this SIP provider line). For outgoing calls, the calling-line number (sender) is replaced (masked) by the registered number (SIP ID in SIP: "From:") and transmitted in a separate field (SIP: "Contact:"). For incoming calls the dialed number (target) is not modified. The maximum number of connections at any one time is limited only by the available bandwidth.

Table for number translation:

Gateway	SIP number incoming to the line	SIP number sent from the line
Outgoing call	"From:"	The number registered at the provider (User ID)
	"From:"	"Contact:"
Incoming call	"To:"	"To:"

- **Link mode:** Externally, the line behaves like a typical SIP account with a single public number (SIP ID). The number is registered with the service provider, the registration is refreshed at regular intervals (when (re-)registration has been activated for this SIP provider line). For outgoing calls, the calling-line number (sender; SIP: "From:") is not modified. For incoming calls, the dialed number (target; SIP: "To:") is not modified. The maximum number of connections at any one time is limited only by the available bandwidth.

Table for number translation:

Link	SIP number incoming to the line	SIP number sent from the line
Outgoing call	"From:"	"From:"
Incoming call	"To:"	"To:"

- **Domain**

SIP domain/realm of the upstream device. Provided the remote device supports DNS service records for SIP, this setting is sufficient to determine the proxy, outbound proxy, port and registrar automatically. This is generally the case for typical SIP provider services.

- Rtg tag

Routing tag for selecting a certain route in the routing table for connections to this SIP provider.

- Port

TCP/UDP port that the SIP provider uses as the target port for SIP packets.

---

 This port has to be activated in the firewall for the connection to work.

- User ID

Telephone number of the SIP account or name of the user (SIP URI).

---

 For a SIP trunking account, the switchboard number is entered here. For incoming calls, any numerals after the switchboard number are interpreted as extension numbers (DDI) and these are passed to the call router. For outgoing calls, DDI numbers received from the call router are combined with the switchboard number. This access data is used to register the line (single account, trunk, link, gateway), but not the individual local users with their individual registration details. If individual users (SIP, ISDN, analog) are to register with an upstream device using the data stored there or on the terminal device, then the line type "SIP PBX line" should be selected.

- Auth-Name

Name for authentication to the upstream SIP device (provider/SIP PBX).

---

 This access data is used to register the line (single account, trunk, link, gateway), but not the individual local users with their individual registration details. If individual users (SIP, ISDN, analog) are to register with an upstream device using the data stored there or on the terminal device, then the line type "SIP PBX line" should be selected.

- Display name

Name for display on the telephone being called.

---

 Normally this value should not be set as incoming calls have a display name set by the SIP provider, and outgoing calls are set with the local client or call source (which may be overwritten by the user settings for display name, if applicable). This settings is often used to transmit additional information (such as the original calling number when calls are forwarded) that may be useful for the person called. In the case of single-line SIP accounts, some providers require an entry that is identical to the display name defined in the registration details, or the SIP ID (e.g. T-Online). This access data is used to register the line (single account, trunk, link, gateway), but not the individual local users with their individual registration details. If individual users (SIP, ISDN, analog) are to register with an upstream device using the data stored there or on the terminal device, then the line type "SIP PBX line" should be selected.

- Secret

The password for authentication at the SIP registrar and SIP proxy at the provider. For lines without (re-)registration, the password may be omitted under certain circumstances.

---

 This access data is used to register the line (single account, trunk, link, gateway), but not the individual local users with their individual registration details. If individual users (SIP, ISDN, analog) are to register with an upstream device using the data stored there or on the terminal device, then the line type "SIP PBX line" should be selected.

- Registrar

The SIP registrar is the point at the SIP provider that accepts the login with the authentication data for this account.

---

 This field can remain empty unless the SIP provider specifies otherwise. The registrar is then determined by sending DNS SRV requests to the configured SIP domain/realm (this is often not the case for SIP services in a corporate network/VPN, i.e. the value must be explicitly set).

- Outb-proxy

The SIP provider's outbound proxy accepts all SIP signaling originating from the LANCOM device for the duration of the connection.

---

 This field can remain empty unless the SIP provider specifies otherwise. The outbound proxy is then determined by sending DNS SRV requests to the configured SIP domain/realm (this is often not the case for SIP services in a corporate network/VPN, i.e. the value must be explicitly set).

- CIn prefix

The call prefix is a number placed in front of the caller number (CLI; SIP "From:") for all incoming calls on this SIP provider line in order to generate unique telephone numbers for return calls.

For example; a number can be added, which the call router analyzes (and subsequently removes) to select the line to be used for the return call.

- Number/Name

The effect of this field depends upon the mode set for the line:

- If the line is set to "Single account" mode, all incoming calls on this line with this number as the target (SIP: "To:") and transferred to the call router.
- If the mode is set to "Trunk", the target number is determined by removing the trunk's switchboard number. If an error occurs, the call will be supplemented with the number entered in this field (SIP: "To:") and transferred to the call router.
- If mode is set to "Gateway" or "Link" the value entered in this field has no effect.

- Codecs

While the connection is being established, the terminal equipment negotiates the codecs that are to be used for voice-data compression. Use the codec filter to restrict the codecs that are permitted and to permit only certain codecs.

---

 If no common the codecs can be agreed upon, no connection is made.

- Codec order

This parameter influences the order in which the codecs are presented during connection establishment.

- Refer

Call switching (connect call) between two remote subscribers can be handled by the device itself (media proxy) or it can be passed on to the exchange at the provider if both subscribers can be reached on this SIP provider line (otherwise the media proxy in the LANCOM device assumes responsibility for switching the media streams, for example when connecting between two SIP providers).

---

 An overview of the main SIP providers supporting this function is available in the Support area of our Internet site.

- Local port number

This is the port used by the LANCOM proxy to communicate with the provider.

---

 If line (re-)registration is deactivated, the local port has to be defined with a fixed value, and this also has to be entered at the provider end as the destination port (e.g. when using an unregistered trunk in the company VPN). This ensures that both ends can send SIP signaling.

- (Re-) registration

This activates the (repeated) registration of the SIP provider line. Registration can also be used for line monitoring.

---

 To use (re-) registration, the line monitoring method must correspondingly be set to "Register" or "Automatic". Registration is repeated after the monitoring interval has expired. If the provider's SIP registrar suggests a different interval, the suggested value is used automatically.

- Line monitoring



Specifies the line monitoring method. Line monitoring checks if a SIP provider line is available. The Call Router can make use of the monitoring status to initiate a change to a backup line. The monitoring method sets the way in which the status is checked.

Possible values:

- Auto: The method is set automatically.
  - Disabled: No monitoring; the line is always reported as being available. This setting does not allow the actual line availability to be monitored.
  - Register: Monitoring by means of register requests during the registration process. This setting also requires "(Re-)registration" to be activated for this line.
  - Options: Monitoring via Options Requests. This involves regular polling of the remote station. Depending on the response the line is considered to be available or unavailable. This setting is well suited for e. g. lines without registration.
- Monitoring interval

The monitoring interval in seconds. This value affects the line monitoring with register request and also the option request. The monitoring interval must be set to at least 60 seconds. This defines the time period that passes before the monitoring method is used again. If (re-) registration is activated, the monitoring interval is also used as the time interval before the next registration.

---

 If the remote station responds to an option request with a different suggested value for the monitoring interval, this is accepted and subsequently applied.

- Trusted

Specifies the remote station on this line (provider) as "Trusted Area". In this trusted area, the caller ID is not concealed from the caller, even if this is requested by the settings on the line (CLIR) or in the device. In the event of a connection over a trusted line, the Caller ID is first transmitted in accordance with the selected privacy policy and is only removed in the final exchange before the remote subscriber. This means, for example, that Caller ID can be used for billing purposes within the trusted area. This function is interesting for providers using a VoIP router to extend their own managed networks all the way to the connection for the VoIP equipment.

---

 Please note that not all providers support this function.

- Privacy method

Specifies the method used for transmitting the caller ID in the separate SIP-header field.

- Active

Activates or deactivates the entry.

- Comment

Comment on this entry.

## SIP mapping

The entries made under SIP mapping establish a series of rules for number translation to SIP lines in the trunk or gateway mode.

- A SIP line in trunk mode is used for mediating between internal numbers and the range of telephone numbers offered by a SIP account.
  - For incoming calls, the destination number (called party ID) is modified. The internal number is used if the called party ID matches with the external telephone number.
  - For outgoing calls, the calling party ID is modified. The external number is used if the calling party ID matches with the internal telephone number.

❗ For SIP mapping on trunk lines, only the extension (DDI) is mapped. The extension is interpreted as those numerals which follow the switchboard number (SIP ID or SIP line).

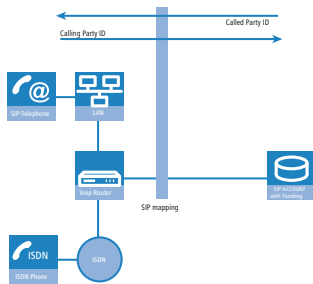

- For a SIP line in gateway mode, the telephone number plan of the upstream SIP PBX is adapted to the internal numbers in the call router.
  - For incoming calls (from the SIP line), the calling party ID is modified. The internal number is used if the calling party ID matches with the external telephone number.
  - For outgoing calls (to the upstream PBX), the destination number (called party ID) is modified. The external number is used if the called party ID matches with the internal telephone number.

❗ For SIP mapping to gateway lines, the full telephone number is mapped. Depending on the configuration, the call number arriving at the ISDN interface can be subjected to further mapping (ISDN mapping).

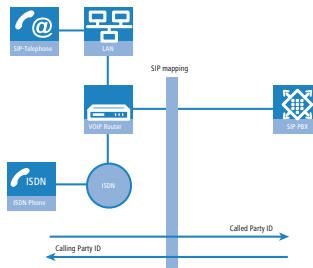

LANconfig: VoIP Call Manager / Lines / SIP mapping

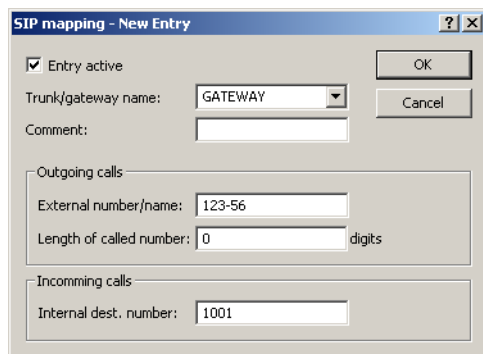

WEBconfig: LCOS menu tree / Setup / Voice Call Manager / Lines / SIP provider / Mapping

- Trunk/gateway name
  - Name of the line which is the target of the call number mapping.
- Comment
  - Comment about this rule.
- External number / name
  - Call number within the range of those used by the SIP trunk account or upstream SIP PBX.

- Length of called number

This value defines the number of numerals required for a called number to be regarded as complete. It only applies to SIP gateway lines with entries that end in a # symbol.

For an outgoing call, the external called number generated from this entry is automatically regarded as complete according to the defined number of numerals, and then forwarded. This process speeds up the dialing process.

Alternatively, the called number is regarded as complete when:

- The user concludes the dialed number with a # symbol, or
- a precisely matching entry was found in the SIP mapping table without a # symbol, or
- the wait time expires.



Setting the length of called number to '0' deactivates premature dialing from the length of called number.

- Internal destination number

Called number inside the range of the LANCOM VoIP Router.



Using the # symbol as a placeholder allows blocks of numbers to be captured by one rule.

## SIP PBX line

These lines are used to configure connections to upstream SIP PBXs, which are usually connected via VPN.

LANconfig: VoIP Call Manager / Lines / SIP PBX lines

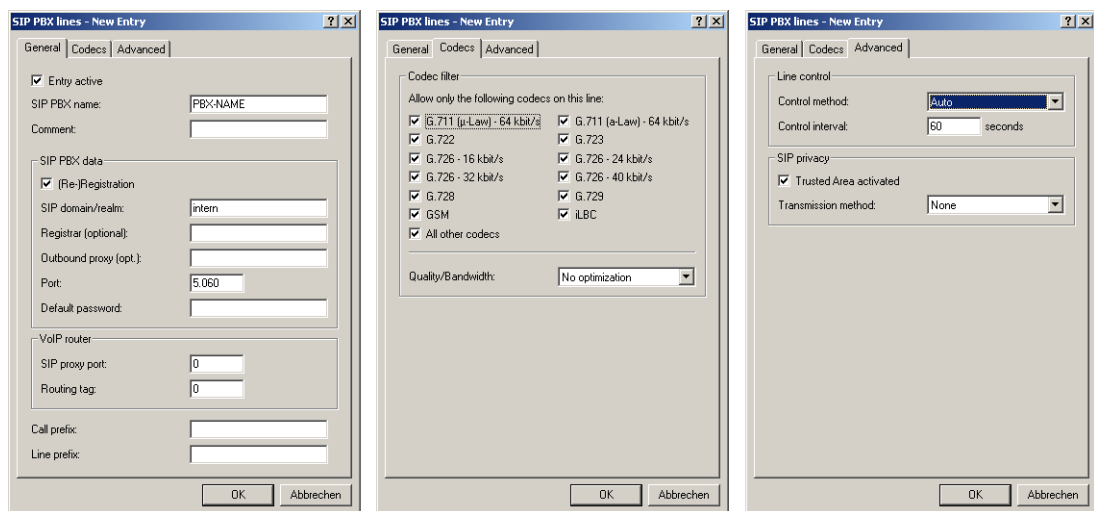

WEBconfig: LCOS menu tree / Setup / Voice Call Manager / Lines / SIP PBX

- Name

Name of the line; may not be identical to another line that is configured in the device.

- Domain

SIP domain/realm of the upstream SIP PBX.

- Rtg tag

Routing tag for selecting a certain route in the routing table for connections to this SIP PBX.

- Port

TCP/UDP port of the upstream SIP PBX to which the LANCOM device sends the SIP packets.

---

 This port has to be activated in the firewall for the connection to work.

■ **Secret**

Shared password for registering with the SIP PBX. This password is only required (a) when SIP subscribers have to log in to the PBX who have not been set up as SIP users with their own access data in the SIP user list or (b) when local SIP authentication is not forced. This means that SIP users can register with the LANCOM device without a password and can log in to the upstream SIP PBX with a shared password if the SIP user's domain is the same as the domain of a SIP PBX line.

■ **Registrar**

The SIP registrar is the point that accepts the login with the configured authentication data for this account in the SIP PBX.

■ **ClIn prefix**

The call prefix is a number placed in front of the caller number (CLI; SIP "From:") for all incoming calls on this SIP PBX line in order to generate unique telephone numbers for return calls.

For example; a number can be added, which the call router analyzes (and subsequently removes) to select the line to be used for the return call.

■ **Line prefix**

With outgoing calls using this line, this prefix is placed in front of the calling number to create a complete telephone number that is valid for this line. With incoming calls this prefix is removed, if present.

■ **Codecs**

While the connection is being established, the terminal equipment concerned negotiate which codecs are to be used to compress the voice data. Use the codec filter to restrict the codecs that are permitted and to permit only certain codecs.

---

 If no common the codecs can be agreed upon, no connection is made.

■ **Codec order**

This parameter influences the order in which the codecs are presented during connection establishment.

■ **Local port number**

This is the port used by the LANCOM proxy to communicate with the upstream SIP PBX.

---

 If line (re-)registration is deactivated, the local port has to be defined with a fixed value, and this also has to be entered into the SIP PBX to ensure that both ends can send SIP signaling.

■ **(Re-) registration**

This activates the (repeated) registration of the SIP PBX line. Registration can also be used for line monitoring.

---

 To use (re-) registration, the line monitoring method must correspondingly be set to "Register" or "Automatic". Registration is repeated after the monitoring interval has expired. If the SIP registrar in the SIP PBX suggests a different interval, the suggested value is used automatically.

■ **Line monitoring**

Specifies the line monitoring method. Line monitoring checks if a SIP PBX line is available. The Call Router can make use of the monitoring status to initiate a change to a backup line. The monitoring method sets the way in which the status is checked.

■ **Monitoring interval**

The monitoring interval in seconds. This value affects the line monitoring with register request and also the option request. The monitoring interval must be set to at least 60 seconds. This defines the time period that passes before

the monitoring method is used again. If (re-) registration is activated, the monitoring interval is also used as the time interval before the next registration.

! If the remote station responds to an option request with a different suggested value for the monitoring interval, this is accepted and subsequently applied.

- **Trusted**

Specifies the remote station on this line (provider) as "Trusted Area". In this trusted area, the caller ID is not concealed from the caller, even if this is requested by the settings on the line (CLIR) or in the device. In the event of a connection over a trusted line, the Caller ID is first transmitted in accordance with the selected privacy policy and is only removed in the final exchange before the remote subscriber. This means, for example, that Caller ID can be used for billing purposes within the trusted area. This function is interesting for providers using a VoIP router to extend their own managed networks all the way to the connection for the VoIP equipment.

! Please note that not all providers support this function.

- **Privacy method**

Specifies the method used for transmitting the caller information in the separate SIP field.

- **Active**

Activates or deactivates the entry.

- **Comment**

Comment on this entry.

## ISDN lines

LANconfig: VoIP Call Manager / Lines / ISDN lines

WEBconfig: LCOS menu tree / Setup / Voice Call Manager / Lines / ISDN

- **Switching name/CO**

Name of the line; may not be identical to another line that is configured in the device.

- **ISDN/S0 bus, Ifc**

ISDN interface(s) with which the LANCOM Wireless Router is connected to the ISDN network. The line entered here are usually configured as ISDN-TE.

- **Domain name, Domain**

Domain in which the calls from/to the ISDN line are managed in LANCOM's SIP world.

- **Call prefix, CIn-Prefix**

With incoming calls using this line, this prefix is placed in front of the calling number so that the correct line is automatically selected for a return call.

- **Entry active, Active**

Line is active / not active.

- **Comment**

Comment on the line

## ISDN mapping

ISDN mapping assigns external ISDN telephone numbers (MSN or DDI) to the telephone numbers that are used internally.

LANconfig: VoIP Call Manager / Lines / ISDN mapping

WEBconfig: LCOS menu tree / Setup / Voice Call Manager / Lines / ISDN / Mapping

### ■ MSN/DDI

External telephone number of the connection in the ISDN network.

For incoming calls that are directed to this number, the corresponding internal telephone number is entered as the destination number. For outgoing calls, this number is transmitted as the caller's number, unless this has been suppressed.

- MSN: Number of the telephone connection
- DDI (Direct Dialing in): Telephone extension number if the connection is configured as a point-to-point line.

! By using the # character as a placeholder, entire groups of call numbers, e.g. when using extension numbers, can be addressed via a single entry.

### ■ ISDN/S0 bus, **Ifc**

ISDN interface(s) used for connecting terminal devices to the LANCOM Wireless Router. These line have to be configured as ISDN-NT.

### ■ Telephone number/SIP name, **Number/Name**

Internal telephone number of the ISDN telephone or name of the user (SIP URL).

For incoming calls, this is the SIP name or internal telephone number of the telephone to which the call from this interface is switched with the corresponding MSN/DDI. For outgoing calls, the SIP name is replaced by the MSN/DDI of the corresponding entry.

! By using the # character as a placeholder, entire groups of call numbers, e.g. when using extension numbers, can be addressed via a single entry.

### ■ Hide your telephone number from the person called, **CLIR**

The display of your telephone number is suppressed so the person called cannot see it.

### ■ Entry active, **Active**

External telephone number is active / not active.

### ■ Comment

Comment on the external telephone number.

## Analog line

LANconfig: VoIP Call Manager / Lines / Analog lines

WEBconfig: LCOS menu tree / Setup / Voice Call Manager / Lines / Analog

- **Name**

Name of the line; may not be identical to another line that is configured in the device.

- **Domain**

The analog line's domain name used for addressing in SIP.

- **Call prefix**

The call prefix is a number placed in front of the caller number (CLI; SIP "From:") for all incoming calls on this analog line in order to generate unique telephone numbers for return calls.

For example; a number can be added, which the call router analyzes (and subsequently removes) to select the line to be used for the return call.

- **Number/Name**

Internal number/SIP URI that each call on this analog line is given as call destination. This number can differ from the telco's actual call number for the analog connection (mapping).



Here you can, for example, enter the telephone number for a group that is to receive incoming calls. This allows you to flexibly control which telephones ring for incoming calls, or to transfer calls to a mobile phone number or answering machine after a certain time.

- **Active**

Activates or deactivates the entry.

- **Comment**

Comment on this entry.

- **Caller-ID signaling**

Providers of analog telephone connections support various services including Caller ID transmission, i.e. the caller's number is shown in the display of the telephone being called. This service is also known as Calling Line Identification Presentation (CLIP). Depending on the country and provider, two different methods of modulation are used to transfer the caller ID over the analog line (FSK or DTMF).

- **Caller-ID transmission requirements**

Apart from selecting the modulation method, different countries and providers also have different time delays in the signaling of the Caller ID over analog lines. The telephone being called expects the Caller ID at a certain time, and so providers should set up their systems accordingly.

Possible values:

- **Default:** This setting causes the standard value for the country where the device is operated to be taken.
- **During ringing:** The Caller ID is transmitted while the phone is ringing, between the first and second ring.

- RP AS: Transmission of the Caller ID is not connected with the ringing but is transferred via a special "alarm signal". This alarm signal is a ringing impulse (Ringing Pulse Alerting Signal, RP-AS). The Caller ID can be transferred after the ringing impulse.
- Line reversal: Transmission of the Caller ID is not connected with the ringing but is transferred via a special "alarm signal". The alarm signal is sent by a brief reversal of polarity in the line (line reversal). The Caller ID can be transferred after the line reversal.

## 15.5 Call Manager Configuration

The Call Manager manages and connects the various subscribers and lines described above with one other. The Call Manager's main task is to determine the correct target subscriber for each call and to select a suitable line for this subscriber. To be able to meet this task, the Call Manager mainly uses two table areas:

- The call routing table
- The tables of local subscribers

As the Call Manager usually switches between internal and external telephone networks with different number ranges, the Call Manager often has to change the numbers that are called, and this is known as number translation.



In the world of VoIP telephony, both numbers and names (such as "anyone@company.com") can be used. Although the following description refers to telephone numbers, this also includes telephone names unless specified otherwise.

The procedure known from internal extension lines is used, whereby connections to external subscribers start with a preceding "0". The Call Manager processes calls to and from all registered subscribers and lines.

### 15.5.1 Process of call routing

The calls are switched in the following steps:

- Processing the calling number (Calling Party ID)

First of all there is a check to see whether a numeric or alphanumeric number is available. Typical dialing separators such as "()-/" and <blank> are removed. A leading "+" is left in place. In this case, the number is still treated as a numeric number. If the check reveals any other alphanumerical character, the number is treated as alphanumeric and remains unchanged.

- Resolving the call in the call routing table

After processing the Called Party ID, the call is passed over to the call-routing table. The entries in the call routing table consist of records of conditions and instructions. The entries are searched through and the first one that satisfies **all** of the conditions is executed.

- Resolution of the call with tables of local subscribers

If no entry is found in the call-routing table, then the Call Manager searches through the list of local subscribers. If an entry is found here matching the number that is called, and that also has the appropriate destination domain, then the call is delivered to the corresponding subscriber.

If no local subscriber is found for whom the number and destination domain match, another pass is made where it suffices for the telephone number of the local subscriber to match the called number; the destination domain is not considered.

- Resolution of the call with default entries in the call-routing table

If the previous passes through the call routing table and the lists with the local subscribers were unsuccessful, the call is checked again in the call routing table. This pass only takes the default routes into account, however. It does not include the numbers and destination domains that were entered in the default routes. Only the source filters are processed, assuming that the default routes has these filters.



- ❗ The procedure described here only considers the call numbers as processed by the Call Router. Mapping to the ISDN or SIP line can also alter the number.

## 15.5.2 Handling the calling party ID

The configuration options for the call router offer numerous options for manipulating the telephone numbers that are used to establish the connection. The call router usually connects different "telephone worlds" (internal and external, SIP and ISDN) that use completely different telephone number ranges. So that the subscribers can communicate successfully with each other, the telephone numbers at the interfaces have to be configured in such a way that, on the one hand, the required subscriber is reached via the correct line and, on the other hand, a return call (automatically upon "engaged", where applicable) can be placed successfully. To enable this return call, the calling number (calling party ID) has to be **after** the processing by the Call Manager, directly before it is delivered to the relevant subscriber.

### Handling outgoing calls

The telephone numbers of outgoing calls are converted depending on the line that is used:

- SIP lines

The treatment of the calling-party ID on SIP lines depends upon the line's operating mode:

- Single account: In the case of an outgoing call over a SIP line, the calling party ID is converted to the number that was entered for the SIP line (SIP ID).
- Trunk and gateway: Please observe the information in section .

- SIP PBX lines

In the case of an outgoing call over a SIP PBX line, the subscriber is registered at the upstream SIP PBX and is part of the telephone number range there. This is why the calling party ID—which represents the internal telephone number or "extension" of the subscriber in this case—is passed unchanged to the SIP PBX line.

- ISDN lines

In the case of an outgoing call over an ISDN point-to-multipoint connection, the calling party ID is converted to the MSN that is entered for the subscriber (or the internal telephone number) in the ISDN mapping table.

If this does not contain an entry for the number that is currently calling, no calling party ID is sent. Similarly, no calling party ID is sent if CLIR (Calling Line Identifier Restriction) is activated.

### Handling incoming calls

The telephone numbers of incoming calls are converted differently depending on the SIP or ISDN subscriber criteria and whether automatic outside line access is active or not.

The calling party ID is changed depending on the following parameters:

- The prefix ("call prefix" or "Cln-Prefix") that is stored for the **line** (default: <blank>).
- The prefix for internal connections with destination ISDN users ("internal ISDN prefix" or "Intern-Cln-Prefix" - default: '99').
- The prefix for internal connections with destination SIP users ("internal SIP prefix" or "Intern-Cln-Prefix" - default: '99').
- The prefix for external connections with destination ISDN users ("external ISDN prefix" or "Extern-Cln-Prefix" - default: <blank>).
- The prefix for external connections with destination SIP users ("external SIP prefix" or "Extern-Cln-Prefix" - default: <blank>).

The activation of automatic outside line access is taken into account by configuring the prefixes appropriately:

- If automatic outside line access is activated, the internal prefixes are typically set to the dial character that is used to reach the internal subscriber, usually '99' or '\*'.
- Without automatic outside line access, the external prefixes are typically set to '0'.

The calling party ID is only extended if the incoming call has a calling party ID. If the calling party ID is blank, no prefix is attached.

It is changed as follows:

- With internal connections, the internal subscriber prefix (SIP or ISDN) is placed in front of the calling party ID.
- With external connections, depending on the (line) call prefix, the following decision is made:
  - (Line) call prefix blank: The external subscriber prefix (SIP or ISDN) is placed in front of the calling party ID.
  - (Line) call prefix not blank: The internal subscriber prefix (SIP or ISDN) **and** the (line) call prefix is placed in front of the calling party ID.



A call is regarded as external if it comes from a "line". If this line is a SIP PBX line, then the call is only external if the incoming calling party ID is preceded by a "0".

### 15.5.3 Call-routing table parameters

LANconfig: VoiP Call Manager / Call router

WEBconfig: LCOS menu tree / Setup / Voice Call Manager / Call router

An entry in the call routing table consists of:

- Conditions that have to be met so that the entry is "considered" appropriate. This includes:
  - Information about which subscriber is to be called; called number/name (Called Party ID), called domain (if appropriate).
  - Information about the calling subscriber; calling number/name, calling domain, source line through which the call enters LANCOM VoIP Router.
- Instructions regarding the procedure for the call:
  - How is the telephone number converted and changed for further processing?
  - Which line should be used to place the call (destination line)?

- Which backup lines should be used if the destination line is not available?

The entries are searched row by row; the first suitable entry is performed. This is why the special entries should be configured first of all, then the general entries.

If an entry is found in the call routing table with the destination line "RESTART", then the complete pass starts again with the new, converted called party ID. The entry for the source line (calling line) is deleted for the next pass.

Both the call routing table and the local subscriber table can contain and process alphanumeric names where this makes sense.

- **Active entry/default route, active**

The routing entry can be activated, deactivated, or marked as a default entry. All calls that can be resolved using the first passes but not using the call routing table or local subscriber table are then automatically resolved using these default entries. You can use any destination name and destination domain; only the source filters that are set are considered

- Priority of the entry, Prio

The Call Manager sorts all entries with the same priority automatically, so that the table can be processed through logically from top to bottom. With some entries, however, the sequence of the entries has to be specified (for the telephone number translation, for example). The entries with the highest priority are automatically sorted to the top.

- Called number/name, Called ID

The called party name or destination telephone number (without domain information) that is called.

The # character is used as a placeholder for any character strings. All characters in front of the # are removed, the remaining characters are used in the "Number/name" field instead of the # character to further establish the connection.

Example: The call routing table contains entry '00049#' as the called number/name and '00#' as the number/name. For all calls with a preceding '0' for outside-line access and the complete dialing code for Germany, only the leading '0' for the outside-line access and the leading '0' for the local area dialing code are retained as the number/name; the country ID is removed. So '00049 2405 123456' becomes '0 02405 123456'.

Independently of this, an alphanumeric number can also be specified.

- Number/name, Dest-ID

This telephone number is used to continue with establishing the connection. If no connection can be established using this telephone number and the corresponding line, then the backup telephone numbers with their associated lines are used

At least one of "Number/name", "1st backup no." or "2nd backup no." has to be filled in. They are evaluated in this sequence. A blank field is skipped.

- Line, Dest-Line

The connection is established using the destination line. Normal destination lines can be:

- ISDN
- All defined SIP lines.

The following special functions can be entered as a destination line:

- REJECT highlights a blocked telephone number.
- USER forwards the call to local SIP or ISDN subscribers.
- RESTART starts a new pass through the call routing table with the previously formed "number/name". The former "source line" is deleted.

---

 This field has to be completed, otherwise the entry is not used.

- 2. Number, Dest-ID-2

This telephone number is used to establish the connection further if nothing is entered in "number/name" or the corresponding "line" is not available. If no connection can be established using this telephone number and the corresponding line, then the third telephone number and the third line is used.

- 2. Line, Dest-Line-2

The connection is established using this line if the second number is used to establish the connection. The same lines can be dialed as for "line".

- 3. Number, Dest-ID-3

Similar to the second number.

- 3. Line, Dest-Line-3

Similar to the second line.

- Called domain, Cld Domain

This entry filters the called domain, the "Called Party Domain". The call router entry is only considered to match if the Called Party Domain for the call matches the domain that is entered here. If nothing is specified, any destination domain is accepted.

The following can be entered as called domains:

- ISDN
- The internal VoIP domain of LANCOM Wireless Router.
- All domains entered for the SIP and SIP-PBX lines.

- Calling number/name, Calling ID

This entry filters the calling number/name, the "calling party ID". It is specified as an internal number or as a national or international telephone number. The domain is not specified. No "0" or other character for a line ID is prefixed; the ID is used as if it comes from the line or from internal telephone calls.

The call router entry is only evaluated as matching if the Calling Party ID for the call matches the number that is entered here. After "#", any characters can be accepted. If nothing is specified here, any Calling Party ID is accepted.

The following special functions can be entered as a calling number:

- LOCAL restricts to internal telephone numbers (without a leading "0").
- EMPTY can be used for Calling Party IDs that are not specified.

- Calling domain, Cln Domain

This entry filters the calling domain. The call router entry is only considered to match if the Calling Domain for the call matches the domain that is entered here. If nothing is specified, each calling domain is accepted.

The following can be entered as calling domains:

- ISDN
- The internal VoIP domain of LANCOM Wireless Router.
- All domains entered for the SIP and SIP-PBX lines.

SIP telephones usually have several line keys, for which different domains can be configured. With this filter, telephone calls are handled depending on the selection that is made using different line keys.

- Source line, Src-Line

This entry filters the source line. The call router entry is only considered to match if the source line for the call matches the line that is entered here. If nothing is specified, any calling line is accepted.

The following can be entered as the source line:

- USER.ISDN for calls from a local ISDN subscriber
- USER.SIP for calls from a local SIP subscriber
- USER# for calls from a local subscriber in general

- All ISDN, SIP and SIP-PBX lines that are entered.
- **Comment**  
Comment on the current routing entry

## Hunt-group functions

The following parameters are available in the LANCOM for configuring hunt-group functions:

LANconfigVoIP Call Manager / Call router / Hunt groups

WEBconfig: LCOS menu tree / Setup / Voice Call Manager / Groups

- **Entry active**  
Activates or deactivates the entry.
  - Default: Active
- **Internal telephone number**  
The hunt group is available under this telephone number or SIP-ID.
  - Possible values: Maximum 64 alphanumerical characters.

! The names of hunt groups may not coincide with the names of users (SIP, ISDN, analog).

- **Comment**  
Comment on the defined entry (64 characters)
- **Members**  
Comma-separated list of the members of the hunt group. Members can be users, hunt groups or external telephone numbers, and so there is no limit on scaling.
  - Possible members: Users, hunt groups, external telephone numbers
  - Possible values: Maximum 128 alphanumerical characters.

! A hunt group may not contain itself or any parents in the hierarchical system—recursion through user entries is not possible. However, loops to parents in the structure can be set up via the .

- **Forwarding method**  
Set the type of call distribution:
  - **Simultaneous:** The call is signaled to all group members at once. If a member picks up the call within the call-forwarding time, the call is no longer signaled to other group members. If nobody accepts the call within the forwarding time, then the call is switched to its forwarding target.
  - **Sequential:** The call is directed to one member of the group after the other. If a group member does not accept the call within the forwarding time, then the call is switched to the next member of the group. If nobody in the group accepts the call within the forwarding time, then the call is switched to its forwarding target.

- Forwarding time

If an incoming call is not picked up by a group member within the forwarding time, then the call is forwarded according to the distribution method selected:

- In case of simultaneous call distribution, the call is forwarded to the forwarding target.
- In case of sequential call distribution, the call is forwarded to the next group member in line. If the group member is the last one, then the call is redirected to its forwarding target.
- Possible values: Max. 255 seconds.
- Default: 0 seconds
- Significant values: 0 seconds. The call is forwarded immediately to the forwarding target (temporarily jumps a hunt group in a hierarchy).



If all members of the group are busy or unavailable, then the call is redirected to the forwarding target without waiting for the forwarding-time to expire.

- Forwarding target

If none of the group members accepts the call within the forwarding time, then the call is switched to the forwarding target entered here. Forwarding targets can be users, hunt groups or external telephone numbers. Only one forwarding target can be entered.

- Possible targets: Users, hunt groups, external telephone numbers
- Possible values: Maximum 64 alphanumerical characters.



If no forwarding target is defined, then the call is rejected as soon as the member list has been worked through, or if all members are busy or unavailable.

The forwarding target only becomes active once the group's forwarding time has expired or if no members are available. Here, too, redirection to a higher level of the hunt-group structure is possible, unlike with the entry.

## 15.5.4 Codecs

LANconfig: VoIP Call Manager / Codecs

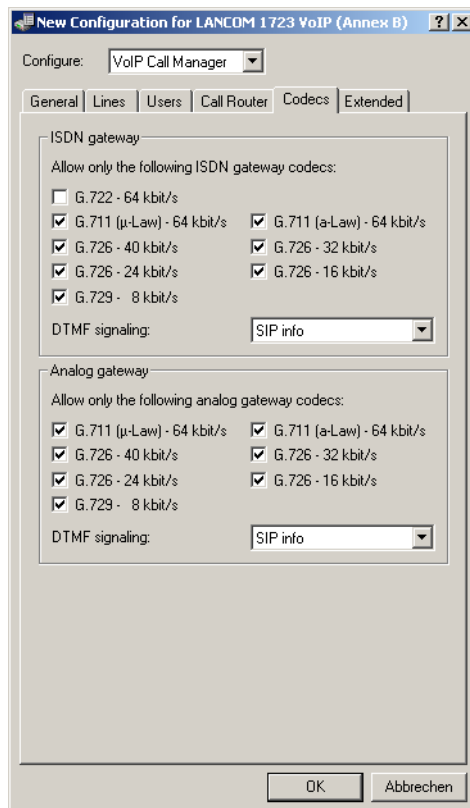

WEBconfig: LCOS menu tree / Setup / Voice Call Manager / General / ISDN gateway codecs

WEBconfig: LCOS menu tree / Setup / Voice Call Manager / General / Analog gateway codecs

- ISDN gateway

During connection establishment, the ISDN terminal devices negotiate which codecs are to be used to compress the voice data. Use the codec filter to restrict the codecs that are permitted and to permit only certain codecs.

- Analog gateway

Use the codec filter to restrict the codecs that are permitted for analog terminal equipment and to permit only certain codecs.

- DTMF signaling

- SIP info: Transmits the DTMF tones according to the SIP info standard
- Events (RFC 2833): Transmits the events in cleartext according to the RFC 2833 standard
- Tones (RFC 2833): Transmits the tones according to the RFC 2833 standard
- Events&tones (RFC 2833): Transmits the events in cleartext and tones according to the RFC 2833 standard



The DTMF signaling settings must match the SIP provider requirements. Defective DTMF signaling settings could make it impossible to establish a connection via the SIP provider.

## 15.5.5 Extended settings

LANconfig: VoIP Call Manager / Extended

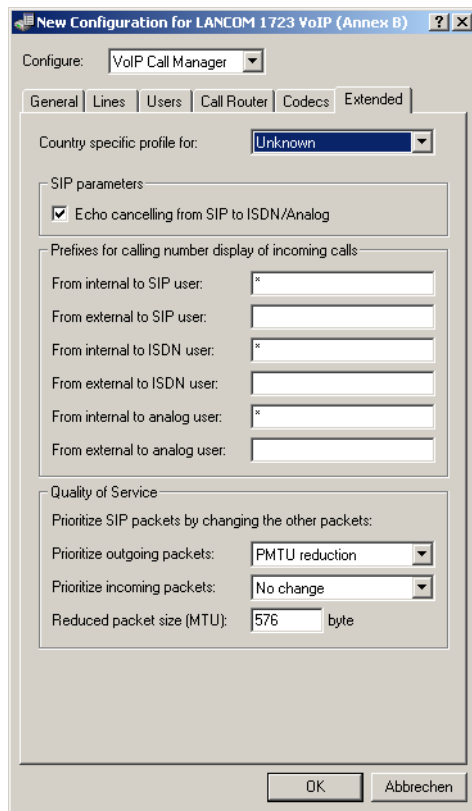

WEBconfig: LCOS menu tree / Setup / Voice Call Manager / General / ISDN gateway codecs

### ■ Echo canceling from SIP to ISDN

Activates the echo canceling of remote echoes. With an echo that is too strong, subscribers can hear their own voices after a short delay. Activating this option reduces the ISDN echo at the SIP > ISDN gateway.

### ■ Prefix from internal to SIP user

This prefix is added to the calling party ID, if available, for an incoming, **internal** call if the call is directed to a SIP user.



A call is regarded as external if it comes from a "line". If this line is a SIP PBX line, then the call is only external if the incoming calling party ID is preceded by a "0". All other calls are regarded as internal.

For more information about handling the calling party ID, see .

### ■ Prefix from external to SIP user

This prefix is added to the calling party ID, if available, for an incoming, **external** call if the call is directed to a SIP user.

### ■ Prefix from internal to ISDN user

This prefix is added to the calling party ID, if available, for an incoming, **internal** call if the call is directed to an ISDN user. If a line prefix is defined, this is placed in front of the whole of the called number.

### ■ Prefix from external to ISDN user

This prefix is added to the calling party ID, if available, for an incoming, **external** call if the call is directed to an ISDN user. If a line prefix is defined, this is placed in front of the whole of the called number.



- Prefix from internal to analog user
 

This prefix is added to the calling party ID, if available, for an incoming, **internal** call if the call is directed to a analog user. If a line prefix is defined, this is placed in front of the whole of the called number.
- Prefix from external to analog user
 

This prefix is added to the calling party ID, if available, for an incoming, **external** call if the call is directed to a analog user. If a line prefix is defined, this is placed in front of the whole of the called number.
- Prefer outgoing packets
 

Depending on the audio codec that is used for SIP calls, sufficient bandwidth through the firewall is reserved (provided sufficient bandwidth is available). To control the firewall, you can configure how the remaining data packets that do not belong to the SIP data stream are handled.

  - PMTU reduction
 

The subscribers of the data connection are informed that they should only send data packets up to a certain length (Path Maximum Transmission Unit, PMTU).

    - Fragmentation
 

The LANCOM Wireless Router reduces the data packets by fragmenting them to the required length.

      - No change
 

The length of the data packets is not changed by the VoIP operation.

For more information, see the description of PMTU and fragmenting with regard to quality of service.
  - Prefer incoming packets
 

Similar to the outgoing data packets, you configure how non-VoIP data packets are handled when bandwidth is reserved for SIP data.

    - PMTU reduction
 

The subscribers of the data connection are informed that they should only send data packets up to a certain length (Path Maximum Transmission Unit, PMTU).

      - No change
 

The length of the data packets is not changed by the VoIP operation.
- Reduced packet size
 

This parameter specifies the packet size that should be used for PMTU adjustment or fragmentation while the SIP data have priority.

## 15.6 PBX functions for LANCOM VoIP Router

LANCOM VoIP Routers can provide small companies or subsidiaries with all of the functions of a classical private branch exchange (PBX).

- Telephony functions such as call hold, swap, connect or transfer
- Hunt group function with flexible call distribution and cascading of hunt groups
- Multiple logins to use various telephones under one telephone number



Please note that the extent to which features such as connect call and automatic call transfer (redirection) are supported by SIP providers can differ enormously. It is impossible to guarantee that this function will work properly with all combinations of SIP devices and SIP providers. We recommend that you use LANCOM VP-100 and LANCOM Advanced VoIP Client terminal equipment.

## 15.6.1 Connect and forward call

The integration of SIP telephones and VoIP routers into existing telephone structures means that we have to take a fresh look at familiar functions such as transferring calls. Call transfer means that a call that has already been placed (routed) is redirected to a new destination either spontaneously by the user (connect call) or by automatic call forwarding set up in advance. SIP-based VoIP telephony uses processes which are fundamentally different to technologies used until now. For example, ISDN and analog terminal devices require a telephone exchange that usually has to continue to manage the connection after transfer. SIP telephones can transfer calls without any need of a telephone exchange: The devices make a connection over the shortest possible route and the call router stops its management function immediately after the connection has been established. The SIP exchange is also able to handle signaling over SIP and the actual data transfer over RTP in different ways.

Due to the differences arising from the various types of terminal device, the easiest way to understand call transfer in a LANCOM VoIP Router is to consider different scenarios and to explain the terminology.

### Active and passive transfer

When looking at the technical details, it is important to consider the end from which call transfer is initiated. "Local" users are all SIP, ISDN or analog users who are accessible via the LANCOM VoIP Router in their own LAN. "External" users are those accessible via a line (SIP account, SIP trunk, SIP PBX, ISDN or analog).

- Active: A local subscriber initiates call transfer
- Passive: An external subscriber initiates call transfer

### Call transfer with and without consulting

A subscriber transferring a call can either directly hand over an active call to a third subscriber (unattended call transfer), or a separate call can be made to a third subscriber to communicate the call and then transfer it (attended call transfer).

### Charges for calls when transferring to external users

The transfer of a call from an external caller to a third party who is also external carries the risk that charges will arise for the ongoing call, even though the initiating subscriber has ended the call.

### The LANCOM VoIP Router's job during call transfer

Irrespective of the terminal devices involved in the call transfer, a LANCOM VoIP Router can take over a variety of tasks:

- Passthrough: Both subscribers in the call transfer are on the same side of the connection, e.g. transfer from a local to a local subscriber.
- Delegate: The call transfer is not handled by the LANCOM VoIP Router itself but by an upstream exchange, e.g. in a VoIP PBX that is accessible via a PBX line.
- Switching: The LANCOM VoIP Router handles the signaling and the data transfer between subscribers.

### Active forwarding to local users

1. An external user **A** makes a call to an internal user **B** (SIP, ISDN or analog).
2. **B** makes an additional call to a local user **C**. These two users can call each other directly, and so the LANCOM VoIP Router only handles the signaling via SIP; the data transfer via RTP takes the shortest possible route.
3. The local user **B** then transfers the call (with consultation) to **C**.

#### 4. The LANCOM VoIP Router manages the call transfer.

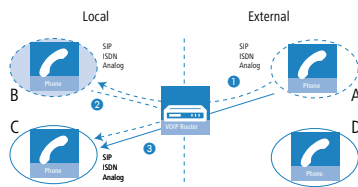

! In case of SIP at the external subscriber, this requires that Transfer in SIP (re-invites) is fully supported.

##### Active transfer to external SIP users

1. An external SIP user **A** makes a call to an internal user **B** (SIP, ISDN or analog).
2. **B** makes an additional call to an external user **D**.
3. If the two external SIP users **A** and **D** can be accessed over the same SIP line, the LANCOM VoIP Router delegates the management of the call transfer to the upstream provider.

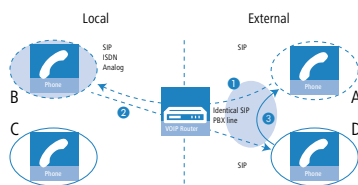

! Requires that the VoIP PBX fully supports Transfers in SIP (re-invites).

##### Active transfer to external ISDN or analog users

In some cases upstream exchanges do not support the delegation of call-transfer functions to external ISDN or analog users, often due to the unclear situation about who carries the call charges. For this reason, call transfer between external subscribers is always handled by the LANCOM VoIP Router.

1. An external subscriber **A** (external SIP, ISDN or analog) calls an internal user **B** (SIP, ISDN or analog).
2. **B** makes a further call to an external subscriber **D** (ISDN or analog).
3. The local user **B** then transfers the call (with consultation) to **A**.
4. If the two external users **A** and **D** use different protocols (SIP, ISDN or analog) then the LANCOM VoIP Router handles the management and conversion of the data.

5. If both external users **A** and **D** use SIP the LANCOM VoIP Router cannot enable the call transfer.

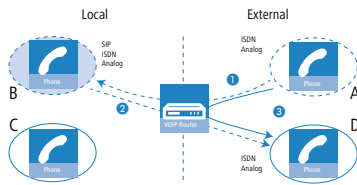

⚠ Requires that the VoIP PBX fully supports Transfers in SIP (re-invites).

Passive forwarding between local users

1. An internal user **B** (SIP, ISDN or analog) calls an external user **A** (at a SIP PBX line).
2. **A** makes an additional call to a local user **C**.
3. The external user **A** then transfers the call to **C**.
4. The LANCOM VoIP Router manages the call transfer. If the connected subscribers **B** and **C** are internal users, the LANCOM VoIP Router controls the SIP data for signaling only and enables RTP-based data transfer over the shortest possible route directly between the SIP users.

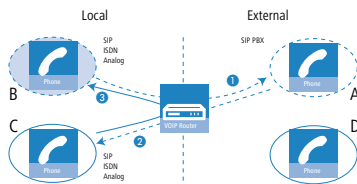

⚠ Requires that the VoIP PBX fully supports Transfers in SIP (re-invites).

Passive transfer from local to external users

1. An external user **A** (at a SIP PBX line) makes a call to an internal user **B** (SIP, ISDN or analog).
2. **A** makes an additional call to an external user **D** (who is also a subscriber to the same SIP PBX line as **A**).
3. The external user **A** then transfers the call from **B** to **D**. To do this, the LANCOM VoIP Router has to open an external connection to **D**.

- ! The LANCOM VoIP Router can only establish this connection if D can be accessed over the same SIP PBX line as A, i.e. if external call forwarding is permitted.

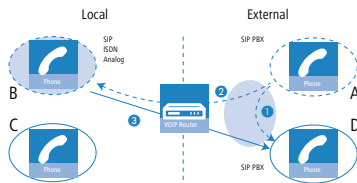

- ! Requires that the VoIP PBX fully supports Transfers in SIP (re-invites).

## 15.6.2 Spontaneous call management by the user

### Functions for spontaneous call management

Calls can be managed on an individual basis and the LANCOM VoIP Router supports the services known from the ISDN network:

- With call hold the user can place an active call into a wait state. In this state, the user can for example make a call to another person.
- Establishing an additional call while a call is on hold is referred to as consulting. This call can be ended again and the conversation with the call on hold continued.
- With transfer call, the user can switch to and fro between two connections. The user is only connected with one caller at a time, while the other caller is put on hold.
- With call swap the user switches an active call over to another call which is on hold. The two callers are then connected and the user is no longer involved in the call. A subscriber transferring a call can either directly hand over an active call to a third subscriber (unattended call transfer), or a separate call can be made to a third subscriber to communicate the call and then transfer it (attended call transfer).

### Using spontaneous call management with various telephones

SIP telephones and SIP softphones generally feature special keys or menu entries to manage calls. Depending on the model or program, different terms may be used the the functions are as follows:

- HOLD: Places an active call into a wait mode or swaps between two active calls. On ISDN and analog telephones this function is often referred to as the F-key/Flash/Call hold. Flash function (F key).
- HANG UP: End the current call.
- SWAP: Swap between two active calls (depending on the ISDN telephone, this may be initiated by a display-menu entry, a special key, or the "F" key).
- CONNECT: Initiates the call's transfer (can be triggered by "hanging-up" with an active call and a call on hold)\*.

These functions can be used to manage calls as follows:

Holding/consulting and continuing with calls	SIP	ISDN	Analog
To place a call on hold, press the Flash/Call hold key (or 'F' on analog phones).	HOLD	HOLD or F	R

## 15 Voice over IP (VoIP)

Holding/consulting and continuing with calls	SIP	ISDN	Analog
The caller can no longer hear you and you can initiate a second call by dialing a telephone number (consulting).			
To continue with a call which is on hold, press the Flash/Call hold key again (or 'F 2').	HOLD	HOLD or F	F 2
If the consultation call has not yet been picked up, you can stop the consulting by hanging up the handset on a SIP or ISDN telephone*.	HANG UP	HANG UP	HANG UP
You can stop the consultation call with the appropriate menu function of the telephone (e.g. 'Cancel') or 'F 1' (analog)*.			

Swap call	SIP	ISDN	Analog
To open a second line during a call, first press the Flash/Call hold key (or 'F' on analog phones).	HOLD	HOLD or F	R
The other caller can no longer hear you.			
Dial the number for the second caller while the first call is on hold.	123456789	123456789	123456789
If you cannot reach the second caller, you can return to the call which is on hold by pressing the hold key (or 'R').			
As soon as two simultaneous connections are open, you can use the hold key (or swap key for ISDN phones, 'R' and '2' for analog phones) to swap to-and-fro between the two connections.	HOLD	SWAP	F 2
You will be connected to one of the other callers; the other caller is placed on hold.			
To end an active call, hang up the handset on SIP or ISDN telephones, and on analog phones press 'R 1'.	END or HANG UP*	END or HANG UP*	F 1
The call which is on hold is not automatically reactivated, but it will be signaled (ringing phone) for a period of 15 seconds.			

Call transfer, consult	SIP	ISDN	Analog
To open a second line during a call, first press the Flash/Call hold key (or 'F' on analog phones).	HOLD	HOLD or F	R
The other caller can no longer hear you.			
Dial the number for the second caller while the first call is on hold.	123456789	123456789	123456789
If you cannot reach the second caller, you can return to the call which is on hold by pressing the hold key.			
As soon as you have established two simultaneous connections you can connect the two callers with the connect key (or 'R' and '4' on analog phones) or by hanging up the handset.*	CONNECT or HANG UP*	CONNECT or HANG UP*	R 4 or HANG UP
Optionally you can switch between the two lines as often as you like before transferring. Call transfer always connects the active call and the call on hold.			
You have no more active calls. You can either hang up or make a new call.	HANG UP 123456789	HANG UP 123456789	HANG UP 123456789

Call transfer, blind	SIP	ISDN	Analog
To open a second line during a call, first press the Flash/Call hold key.	HOLD	HOLD	HOLD
The other caller can no longer hear you.			
Dial the number for the second caller while the first call is on hold.	123456789	123456789	123456789
Press the connect key (or 'R' and '4' on analog phones) or hang-up the handset before the second connection has been established.*	CONNECT or HANG UP*	CONNECT or HANG UP*	R 4 or HANG UP
The two callers will now be connected "in the background".			

Call transfer, blind	SIP	ISDN	Analog
You have no more active calls. You can either hang up or make a new call.	HANG UP 123456789	HANG UP 123456789	HANG UP 123456789

 \*In some cases, SIP or ISDN telephones can be configured so that hanging-up the handset either causes the consultation or active call or be terminated, or a call transfer is triggered ("Connect").

### 15.6.3 Configure permanent call forwarding

Along with spontaneous call transfers as controlled by a subscriber during a call, it is often useful to set up a permanent call forwarding ("redirect calls"). For example, a call should be forwarded when a line is busy, if there is no answer within a certain period, or in case of absence (e.g. vacation).

There are two possibilities for configuring permanent call forwarding.

- Via the telephone or terminal device itself with the aid of control characters
- In the configuration of the LANCOM VoIP Router by means of the management tools (LANconfig, WEBconfig or telnet)

 If permanent call forwarding is activated by both methods, then the behavior of the call forwarding follows the last respective action.

#### Triggering call forwarding

The following events can be used as a trigger or condition of the permanently configured call transfers:

- CFU, call-forwarding unconditional
- CFB, call forwarding on busy
- Delayed call forwarding, CFNR (call forwarding no reply); CFNA (call forwarding no answer)
- No call transfer

All types of call forwarding can be used in parallel with your own target telephone numbers. If multiple call-forwarding conditions are active, the following priority applies:

1. CFU
2. CFB
3. CFNR

If, for example, call forwarding on busy is activated and a corresponding target number has been defined, then the call will be forwarded to this target before referring to a target as defined for forwarding on busy.

 If the incoming call has already been forwarded from another telephone number, then forwarding will not take place again, so as to avoid endless call-forwarding queues.

#### Configuring user settings in the LANconfig see

#### Configuring user settings with the telephone with character strings

For the configuration of user settings with the telephone, the various technologies (SIP, ISDN, analog) each offer specific possibilities. With ISDN telephones, call forwarding can be controlled by the functional protocol in the ISDN signaling or via so-called keypads (character strings). For analog telephones the same character strings are transferred by DTMF. The SIP protocol provides another option with its REFER method that is supported by most SIP phones and SIP softphones. However, call forwarding can only be controlled by the terminal device. To enable a uniform behavior for users in mixed infrastructures, the LANCOM VoIP Router offer an additional variant of call forwarding for SIP phones, as is presented here in comparison with ISDN and analog telephones.

Immediate call forwarding	SIP	ISDN	Analog
Switch on and define target for call forwarding	*21*TargetNo#	*21*TargetNo*MSN#	*21*TargetNo#
Switch off	#21#	#21#*MSN	#21#
Switch off temporarily, maintain call-forwarding target	#22#	#22*MSN#	#22#
Switch on again, maintain defined call-forwarding target	*22#	*22*MSN#	*22#

Call forwarding on busy	SIP	ISDN	Analog
Switch on and define target for call forwarding	*67*TargetNo#	*67*TargetNo*MSN#	*67*TargetNo#
Switch off	#67#	#67*MSN#	#67#

Call-forwarding on no reply	SIP	ISDN	Analog
Switch on and define target for call forwarding	*61*TargetNo#	*61*TargetNo*MSN#	*61*TargetNo#
Switch off	#61#	#61*MSN#	#61#

Please note the following when using character strings to configure call forwarding:

1. Some ISDN telephones feature special keys or menu entries to configure call forwarding, and these can be used as an alternative to the listed character strings. Refer to the documentation from the corresponding manufacturers.

#### 15.6.4 Fax via T.38 – Fax over IP (FoIP)

The migration of telephone infrastructure towards VoIP also increases the demand for fax devices to communicate over VoIP. Even in the age of e-mail, fax transmissions continue to be highly important in legal respects as legally binding documents such as contracts and invoices can be far more easily handled by fax than with the alternative of e-mails with digital signature. The integration of fax devices into VoIP infrastructure can be implemented in two ways:

- Fax messages are transmitted via landline just like a conventional fax.
- The transmission takes place over an Internet connection. Options for this are as follows:
  - The fax signals are transmitted like voice data over a VoIP connection, referred to as "fax over VoIP". Fax transmission should only make use of the G.711 codec for compression, as other codecs are inferior at converting fax tones, which are designed for analog networks, into digital VoIP data. Due to the highly sensitive nature of fax connections, this method can only be used with high-quality connections, whereby the transmission speed is sub-optimal.
  - For example, with the "store-and-forward" principle (ITU-T.37), fax messages are passed from the fax machine to a gateway that stores and converts the fax document. In a second step the fax is transmitted to the destination for conversion back into a fax format. Alternatively fax messages can be sent by e-mail (fax-to-mail and mail-to-fax). Solutions of this type may not meet the legal requirements mentioned above, due to the fact that there is no direct connection between transmitter and receiver.
  - With "real-time routing" of fax messages, on the other hand, a direct connection is established between the two fax machines and all data is transferred in real time. The fax machines are connected virtually over the Internet. Communication between the two fax machines follows the ITU-T.38 standard for converting standard fax signals. This variant is also known as Fax over IP (FoIP). The fax messages are not transferred as acoustic signals via VoIP, but rather in a special protocol, the IFP (Internet Facsimile Protocol), that embeds the signals in UDP/TCP packets.

To enable fax transmissions with T.38, either the fax machines themselves have to support the T.38 standard, or they must be interconnected over the Internet via fax gateways. LANCOM VoIP Routers and LANCOM Routers with the LANCOM VoIP Advanced Option or LANCOM VoIP Basic Option support the T.38 standard and are thus suitable for operation as fax gateways in VoIP infrastructure.

The fax machines are connected to the LANCOM VoIP Routers by means of a suitable interface. The fax gateway in the LANCOM VoIP Router handles the conversion of the signals for transmission and reception of fax messages:



- Demodulation of incoming T.30 fax signals
- Conversion of T.30 fax signals into T.38 IFP packets
- Transmission of IFP packets between transmitting and receiving gateways
- Conversion of T.38 IFP packets into T.30 fax signals
- Modulation of T.30 fax signals and transmission to the fax machine

With the device type "fax" or "telephone/fax" is selected in the analog or ISDN user settings the LANCOM VoIP Router automatically recognizes a fax for transmission and it attempts to transmit via F.38/FoIP. If the remote site does not support this method, the LANCOM VoIP Router automatically uses the fax over VoIP-version using G.711 compression.

 Successful transmission of fax via FoIP requires that the VoIP infrastructure also supports the T.38 standard. For example, where a public SIP provider is involved, this provider also has to offer T.38 support.

## 15.6.5 Hunt groups with call distribution

### Introduction

Calls are normally intended for an individual or their telephone number. Occasionally it is not important to speak to a particular individual, but to anybody in a certain department or with a certain function. In this case, telephone infrastructure collects multiple users into hunt groups where they can all be reached under a single shared telephone number. The group call function can then follow certain rules to distribute or forward incoming calls to the call group.

### Call distribution

A hunt group consists of two or more users, or even other hunt groups, as potential destinations for an incoming call. Hunt groups are comparable to local users and have their own number and, as such, they can be used as a target number in the call router.

Incoming calls can be distributed by a variety of methods, allowing different scenarios to be realized.

- Calls are signaled to all group members at the same time (simultaneous)
- Calls are signaled to one member of the group after the other, in a set order (sequential)

Along with the members of the hunt group and distribution method, also to be defined are a call-forwarding time and and call-forwarding target, all of which control the call-distribution procedure. The forwarding time determines the time period during which the dialed user can answer a signaled call. The forwarding target defines where the call is to be forwarded to (user, group, internal or external call number) for the case that none of the group members picks up the call within the forwarding time—if no forwarding target is defined, then the call is rejected.

### Cascading of hunt groups

The defined hunt groups can themselves be members of a higher-level hunt group, just as hunt groups can be entered as the forwarding target for a higher-level hunt group. These options enable the establishment of a cascaded hunt-group structure which can form highly complex scenarios by using a multitude of branches. These branches represent the hunt groups and the end points are the users themselves. The following rules apply to structures of this type:

- If a hunt group is used as a member, then this lower-level hunting group causes a new "branch" in the structure to open up when that member receives a call.
- When a lower-level hunt group opens, certain parameters that have been defined, e.g. forwarding time, etc., apply.
- This branch from the lower-level group only remains open for as long as the member in the upper-level hunt group is being signaled according to the settings. If the next member in the upper-level hunt group is reached, then the entire branch along with all of its other sub-branches is closed. The system does not wait until all possible combinations along the branch have been tried out. It is thus possible that there are members defined in a lower-level hunt group who cannot be reached because of settings in the upper-level groups.
- If a member of a hunt group picks up the call, all open branches are closed and all attempts to reach forwarding targets are stopped.

## 15 Voice over IP (VoIP)

- If a call remains unanswered after signaling all of the members of an (upper or lower-level) hunt group, then the call is passed on to the call-forwarding target. This means that any call-forwarding times which may be running in the upper-level hunt groups are ended. In this case the call "jumps" out of the hunt-group structure and is given a new target.

Example: The following hunt groups have been defined:

Group telephone number	Comment	Members	Forwarding method	Forwarding time	Forwarding target
100	Entire company	200, 300, 400	Simultaneous	10	ext. Telephone number
200	Service Dept.	201 to 209	Simultaneous	10	100
300	Marketing Dept.	301 to 309	Sequential	10	200
400	Sales Dept.	409	Sequential	15	100
410	Sales Europe group	411, 412, 413, 414, 415	Sequential	10	400
420	Sales America group	421, 422, 410	Sequential	30	400
430	Sales Asia group	431, 432, 410	Sequential	30	400

Each department or group has users who use the final digits in the telephone number, i.e. 411 to 419 for the Sales Europe staff and 409 for the Sales team secretary. Only the group call numbers are communicated externally because all staff members tend to travel frequently on business. The purpose of the hunt-group structure is to connect each customer with a competent staff member in the shortest possible time.

An incoming call directed to the telephone number 420 for a Sales America team member is handled as follows:

1. The call is signaled to the users 421 and 422 in this group for 30 seconds each. If there is no answer, then the hunt group 410 is activated for 30 seconds—a member of the Sales Europe team should take care of the customer when Sales America no team members are available.
2. In the Sales Europe team, the call are distributed to each number for 10 seconds. The hunt group has five members, but with a forwarding time of just 10 seconds, not all of the users can be signaled: The branch is only opened for a maximum of 30 seconds by the upper-level group, in this case 420. This is a way of limiting the maximum waiting time for a customer. If the first three signaled members of the lower-level group 410 do not answer, then the call jumps back to the upper-level hunt group 420.
3. There is still nobody available in the upper-level hunt group 420, and so the call is directed to the call-forwarding target 400.
4. Hunt group 400 directs the call to the team secretary 409. If here nobody answers for 15 seconds then the call-forwarding target 100 is used, which addresses the entire company.
5. Hunt group 100 calls all of the numbers in the hunt groups 200, 300 and 400 simultaneously. If even then nobody answers within 10 seconds, then the hunt group forwards the call to an external telephone number, for example a 24/7 call center.

### Configuring hunt-group functions , see

## 15.6.6 Multi-login

For subscribers using multiple terminal devices, e.g. a softphone on PC and a "normal" telephone on the desktop, multiple SIP, ISDN or analog telephones all using the same internal telephone number can log on to the LANCOM VoIP Router. Multi-login telephones behave like a single user in a hunt group with 'simultaneous' call distribution:

1. Incoming calls are signaled **simultaneously at all** telephones with this internal number.
2. As soon as a call is picked up at one of the telephones, signaling at the other devices stops.
3. Other incoming calls are signaled at all telephones. If one of the telephones is 'busy', then the entire multi-login group is taken to be 'busy'.

4. Outgoing calls can be made from every telephone without limitation.
5. For a multi-login group only one call forwarding setting (call redirection) can be configured. This applies to all telephones and can be set from any telephone.

To use multi-login, multiple telephones can be set to have the same internal telephone number.

## 15.7 VoIP media proxy – Optimized management for SIP connections

When connecting or forwarding calls between remote subscribers over different SIP lines, the SIP proxy in the LANCOM VoIP Router attempts to connect the two callers by means of a REFER or a Re-INVITE. The two external subscribers are not always able to reach one another directly and so the connection may fail. This is because the SIP providers do not make the necessary adaptations, e.g. translation of the target IP addresses. To improve performance in these situations, the SIP proxy in the LANCOM VoIP Routers has been additionally equipped with a media proxy.

The media proxy helps to establish connections and forward calls between subscribers who are reachable over different types of telephone line (e.g. SIP PBX line and SIP provider line). The media streams, generally RTP connections, remain unchanged. The media proxy changes the ports and IP addresses in the data packets and it adapts special media end points to the corresponding target networks (ARF networks, interface and IP address).

### 15.7.1 Multiple media streams in one SIP connection

The SIP protocol can negotiate multiple data streams in a session, e.g. separate media streams for audio and video. Each stream is handled separately. A data stream initially terminates at the media proxy and continues from the "other side". This provides the data stream with end points at the LAN and WAN sides of the media proxy.

All of the connection information in the direction of the SIP provider can be maintained and all of the necessary changes to IP addresses, ports, etc., are handled by the media proxy.

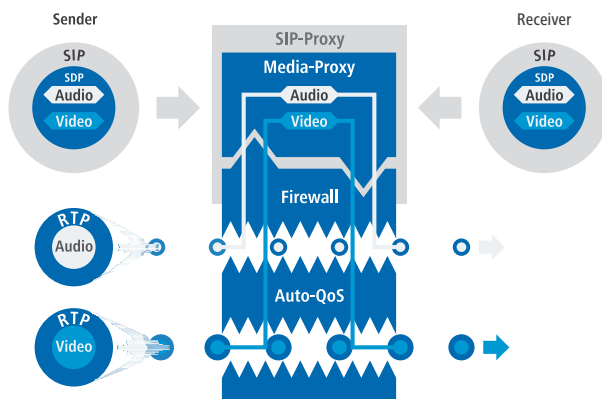

The data streams are all fed through the firewall individually, which enables a differentiated control of the QoS settings, among other things.

Connection management by the media proxy enables all subscribers to be connected to one another, whatever type of line they are using. This makes it possible to connect between SIP, ISDN and analog subscribers, something that a pure

SIP connection is not capable of. Furthermore, the monitoring of individual media streams in the firewall allows certain types of application to be permitted or prevented depending on the connection's end point.

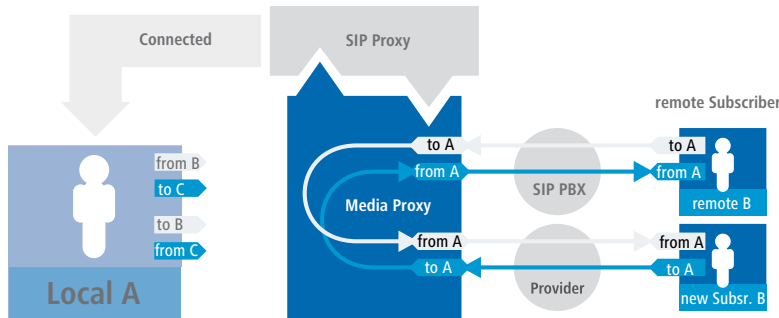

### 15.7.2 Management of media streams in case of an upstream SIP PBX

Even for two subscribers in the same network behind the LANCOM VoIP Router, when connected to an upstream SIP PBX the media proxy generates data streams with separate media end points on the LAN side and on the WAN side (towards the SIP PBX).

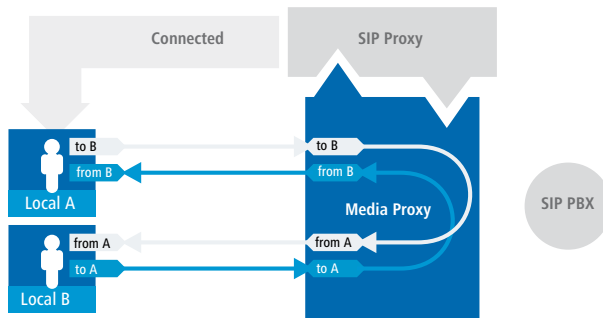

In this case it is not necessary to pass the media streams through the upstream PBX, so the SIP signaling helps the LANCOM VoIP Router to make a new decision on the path to be taken by the connection data. Using the end points in the media proxy the data streams can be connected directly, making a diversion via the SIP PBX unnecessary.

This decision is also made again in the media proxy if a local and an external subscriber are connected in such a way that, ultimately, two local subscribers are connected to one another. The media proxy re-assigns the end points when making the connection, so enabling the direct transmission of the data streams between the local participants.

### 15.7.3 Managing the media streams in the firewall

The media streams are monitored in the firewall as a matter of principle. A firewall rule is generated for each media stream (audio, video). This rule opens a connection for the corresponding IP addresses and ports for each side (LAN-WAN) and carries out a translation according to the IP-port relationships as specified by the media proxy.

### 15.7.4 Automatic QoS rules for media streams

The QoS mechanism in the firewall reserves the maximum possible amount of connection bandwidth as agreed during the SDP negotiation (SDP, Session Description Protocol) and the packets are prioritized accordingly.

### 15.7.5 Handling subscribers using different codecs

When connecting different subscribers, the situation can arise where the codecs available to the subscribers do not match together—there are no common codecs due to the SDP negotiation.

The following situations are to be observed here:

- Connections with different media streams, e.g. a video-telephone call (audio + video) and a traditional telephone call (audio only): This connection will be rejected with the message "Codec mismatch".
- Similar media types (audio-audio, video-video) with codecs that do not match: This connection will be rejected with the message "Codec mismatch".

The media proxy can only connect different subscribers if the media type and the codec type match.

## 15.8 SIP-ID as switchboard number with trunk lines

Until now, SIP trunk lines were given the SIP ID as the switchboard number, which was adapted to suit the telephone number. However, this method is not supported by all trunk-line suppliers.

For this reason LCOS 7.52 and later provides the SIP mapping table that, like ISDN mapping, explicitly defines how telephone numbers are to be processed.

```
0123456789# -> #
```

This allows the extension numbers of the trunk to be translated 1:1 to the internal telephone numbers.



If you have until now used a trunk with automatic switchboard-number translation and you update to LCOS 7.52, then it is imperative that you make a corresponding entry in the SIP mapping table.

## 15.9 Switching at the SIP provider

When switching external SIP connections, the Call Router in the LANCOM VoIP Router generally manages the connection for the full duration of the call. This means that the Call Router retains control over a call even when two external subscribers have been connected to one another and the local subscriber on the LANCOM VoIP Router side has ended the call. In this case, the LANCOM VoIP Router takes up bandwidth for connecting the two external subscribers.

If the connections to the two external subscribers both run via the same SIP provider, an alternative is available whereby call switching is transferred to the provider. The LANCOM VoIP Router no longer takes up the bandwidth.

LANconfig: **VoIP-Call-Manager / Lines / SIP lines**

WEBconfig: **Setup / Voice-Call-Manager / Lines / SIP-Provider / Lines**

- Activate switching at provider (Refer-forwarding)

With this option activated, a REFER is forwarded to the provider when two external lines are connected, and the provider then handles the call transfer. The advantage of this is that the LANCOM VoIP Router no longer requires the bandwidth.

- Possible values: On, off
- Default: Off

! Switching at the provider will only work if both connections are routed via the same provider line.

## 15.10 Handling canonical telephone numbers

Canonical telephone numbers (familiar from mobile phones and starting with '+') were formerly automatically reformatted into standard telephone numbers. '+' was converted to '00'.

As of LCOS 7.52 automatic conversion can be disabled and canonical numbers can be processed directly in the call-routing table. For example, a dedicated line can be defined for canonical numbers.

- WebConfig: **Setup/ Voice-Call-Manager/ General**
- Convert-Canonicals

Activates or deactivates the conversion of canonical numbers into standard telephone numbers.

- Possible values: Yes, No
- Default: Yes

## 15.11 Processing Destination Domains

As the VoIP implementation in the LANCOM VoIP Router handles all calls as SIP calls, telephone numbers and SIP subscribers contain domain information. Furthermore, SIP numbers can also contain alphanumeric characters.

The SIP domains are used in LCOS as follows:

- When SIP subscribers register at upstream PBXs or at the LANCOM VoIP Router itself.

- When SIP subscribers establish a connection.

LCOS supports the following defined domains:

- ISDN for the ISDN interfaces
- All domains that are entered for the lines

### 15.11.1 Registration at upstream exchanges

Local SIP subscribers can only register using the domains that are known. The subscribers authenticate themselves at the local LANCOM VoIP Router with their user name and password. This excludes domains that correspond to an upstream SIP PBX. These registrations are authenticated in the upstream SIP PBX.

If a subscriber tries to register with an unknown domain, then this may be accepted as a local registration.

### 15.11.2 Switching internal calls

For internal connections, internal numbers are generally assigned unambiguously. However, SIP telephones, for example, can register with several "lines", such as '1011@provider.com' and '1011@isdn.com', so that a line can be assigned specifically to the required connection.

With internal switching, an attempt is made to find a subscriber whose number and domain match. Only if this was not successful is the call placed using the destination number only. The domain remains unchanged.

For example, calls that are incoming via ISDN (from <calling\_pty\_id>@isdn) are switched to subscriber 1011 (to 1011@isdn). The call to the SIP telephone is displayed on the ISDN line key. If there is no such subscriber with such a domain, then the call is delivered to the first known subscriber '1011'.

## 15.12 ISDN interface configuration

LANCOM VoIP Router routers feature several ISDN interfaces with which they can be connected to ISDN exchange lines, or with which ISDN terminal equipment can be connected to them.

- ISDN TE interface ("external ISDN connection"): An ISDN interface in TE mode for connection to the ISDN bus of an upstream ISDN PBX or to an ISDN NTBA. This ISDN interface can be used for backup connections over ISDN or as a dial-in interface for remote sites.
- ISDN NT interface ("internal ISDN connection"): With its ISDN interface in NT mode, the LANCOM VoIP Router itself provides an internal ISDN bus. This ISDN interface can be used to connect ISDN PBXs or ISDN telephones.

The factory settings have the ISDN interfaces marked with `set` to TE mode and the ISDN interfaces marked with `set` to NT mode. These ISDN settings can be altered according to your requirements:

- Multiple TE interfaces provide, for example, up to eight B channels as a backup or for dial-in.
- With multiple NT interfaces, for example, a downstream ISDN PBX can be provided with up to eight B channels.

Depending on the combination of ISDN interfaces in TE and NT mode, the hardware must be set up with the functions for bus termination, life-line support and power relay, and the software must be set up with the appropriate protocol. The setting for the protocol allows for the type of ISDN connection to be used (point-to-multipoint or point-to-point).

### 15.12.1 Point-to-multipoint and point-to-point connections

LANCOM VoIP Routers support point-to-multipoint and point-to-point connections:

- Point-to-multipoint connection (point-to-multipoint): Up to 8 ISDN terminal devices can be connected to this type of connection. Terminal equipment can include ISDN telephones and ISDN PBXs, which can be used for connecting yet more equipment. As an alternative, a LANCOM VoIP Router can be connected to a point-to-multipoint connection.
- Point-to-point connection (point-to-point): This type of device is suitable for the connection of one ISDN device only, generally an ISDN PBX. As an alternative, a LANCOM VoIP Router can be connected to a point-to-point connection.

To connect a LANCOM VoIP Router, the interface that is used is set up for the type of line in use.

Equipment connected to an ISDN connection can be addressed in two ways:

- The devices are addressed with a multiple subscriber number (MSN) that is linked to the ISDN connection and cannot be influenced.
- Terminal devices are addressed via a Direct Dialing In-Number (DDI). However, only the switchboard number is associated with the telephone line; the extension numbers that address the individual terminal devices can be chosen at will and are merely suffixes to the switchboard number. The switchboard number, extension and area selection code (not including the leading zero) can be at the most 11 characters long.

---

! The terms "point-to-multipoint connection" and "point-to-point connection" are used in many countries to describe the technical implementation of point-to-multipoint with MSN and point-to-point with DDI. Other countries may use different types of connection and other combinations of protocol and call-number type, or even different names. Please refer to your telephone network operator for the technical specifications of your ISDN connection.

### 15.12.2 Bus termination, life-line support and power relay

The hardware function modes of the ISDN interfaces are set by DIP switches on the underside of the LANCOM VoIP Router.

- Bus termination is obligatory with an ISDN interface in NT mode.

Bus termination is generally deactivated for ISDN interfaces in TE mode. If the LANCOM VoIP Router is the last device at a longer ISDN bus and this itself is not terminated, it may be advantageous to activate the bus termination for an ISDN interface in TE mode.

---

! The supplied adapter must be used if a connection is to be made to an ISDN interface which is set differently to its default settings. This adapter serves to cross-over the contacts in the ISDN interface. Not using the adapter can cause damage to both the LANCOM VoIP Router and to the devices connected with it!

- If **life-line support** is activated, the interfaces ISDN 1 and ISDN 2 are bridged if the device is unavailable due to a power outage or if the ISDN 2 interface is switched off (default: on). The life-line support is used when the device is connected to an external ISDN line over a TE interface with the simultaneous operation of ISDN terminal devices at the internal ISDN connection of an NT interface. If bridged, the ISDN devices can then use the external ISDN bus directly.

To activate life-line support, all four DIP switches (3 to 6) must be up; to deactivate, all four DIP switches must be down.

---

! Life-line support is to be deactivated when both ISDN interfaces are to be operated in the same mode, i.e. as two TE or two NT interfaces. The interfaces are not to be bridged in case of power failure when being operated in this manner!

- The ISDN power relay means that the bus voltage of an external ISDN bus at ISDN 1 is switched through to the terminal equipment connected to another ISDN bus. As a consequence, ISDN equipment operated at the internal ISDN bus of the LANCOM VoIP Router can be operated without its own power supply.

---

! Be sure to deactivate the ISDN power relay if both ISDN interfaces are to be operated in TE mode, such as when both ISDN interfaces are connected to an ISDN NTBA, for example. A power relay in this situation would result in a short-circuit which would damage the device and the ISDN NTBAs!

---

! Further information about settings for life-line support and ISDN power relay can be found in the user manual for your LANCOM VoIP Router.



### 15.12.3 Protocol setting

Parameters for the ISDN interfaces are entered into LANconfig in the configuration area 'Interfaces' on the 'WAN' tab. Under WEBconfig, Telnet or SSH client you will find the settings for the ISDN interface parameters under `Setup/Interfaces/WAN`.

Select the protocol for each ISDN interface according to its application and the ISDN connection type: Point-to-multipoint and point-to-point connections can be used in various combinations at a LANCOM VoIP Router. The following options are available:

- **Automatic** for automatic selection of the operating mode (only in TE mode)
- **DSS1 TE (Euro ISDN)** for connection to a point-to-multipoint ISDN bus.
- **DSS1 TE point-to-point** for connection to a point-to-point ISDN bus.
- **1TR6 TE (German ISDN)** for connection an ISDN bus which uses this protocol (in Germany only).
- **DSS1 NT (Euro ISDN)** to provide point-to-multipoint ISDN interfaces
- **DSS1 NT reverse** to provide point-to-multipoint interfaces while maintaining the ISDN timing of the connected ISDN line, please refer to
- **DSS1 NT (point-to-point)** to provide point-to-point ISDN interfaces
- **DSS1 NT point-to-point reverse** to provide point-to-point interfaces while maintaining the ISDN timing of the connected ISDN line, please refer to
- **DSS1 timing** to maintain the ISDN timing of the connected ISDN line, please refer to
- **Off**

---

 NT mode operation always has to be set manually.

---

 If an ISDN device is attached to an ISDN interface that is set to auto and is not recognized properly, set the required protocol manually.

### 15.12.4 ISDN connection timing

To ensure trouble-free transmission, all of the components in the ISDN system (LANCOM VoIP Router, upstream and downstream ISDN PBXs and ISDN terminal devices) have to use the same ISDN timing. In the LANCOM VoIP Router, an ISDN interface in TE mode can take on the timing of the ISDN line. The TE interface enables the device itself to behave like a terminal device. In NT mode, the LANCOM VoIP Router can pass on the on this timing over the ISDN interfaces to any connected terminal equipment or downstream ISDN PBXs. The NT interface enables the device itself to behave like an exchange.

There are various ISDN interface settings to define the ISDN interface which is to supply the LANCOM VoIP Router with the ISDN timing to be passed on to the devices at the NT interfaces.

- **Automatic:** If no interface has been manually selected for the timing, the device automatically searches for a TE interface that is supplying a timing. To ensure that the timing is synchronous, the TE connectors constantly try to keep the connection activated. This ensures that the timing continues to be supplied even if one of multiple TE lines should be shut off. If none of the TE connectors supply a timing, then the timing system runs "freely" and uses the internal timing of the LANCOM VoIP Router.
- **DSS1 timing:** This setting takes on the ISDN timing from the connection for use by the LANCOM VoIP Router and further devices connected over the NT interface. In this way, the timing can be switched through in parallel to an existing ISDN PBX at a point-to-point connection. Apart from passing on the ISDN timing, the interface is not active.
- **DSS1 NT reverse** or **DSS1 NT point-to-point reverse:** When all ISDN interfaces are operated in NT mode, the timing system runs "freely" because there is no TE interface to take on the ISDN timing. If in this case the ISDN connections are connected, for example, to an ISDN PBX which is being supplied with ISDN timing from another source, then interference to the transmission may arise because the timing of the LANCOM VoIP Router is not synchronous to that of the PBX. In such cases, the reverse setting allows the ISDN timing to be taken from an NT-mode interface, so ensuring that the LANCOM VoIP Router runs synchronously with the overall system.

## 15.13 Configuration examples

### 15.13.1 VoIP telephony for stand-alone use

This example shows how to configure a LANCOM which is used as a central device for Internet connectivity and VoIP telephony at a new site.

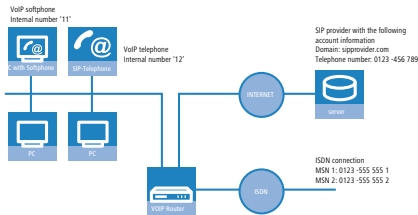

#### Destination

- Internal telephony with SIP telephones and SIP softphones.
- Access to internal terminal equipment via the MSNs.
- External telephony via the SIP provider with backup over ISDN.
- Calls to emergency and special numbers via ISDN.

#### Requirements

- LANCOM connected to the LAN and WAN, an ISDN TE interface is linked to the ISDN NTBA. The Internet connection has been set up.
- A dialing plan with a unique internal telephone number for all terminal equipment to be connected, here, for example, the number '11' for the VoIP softphone and the number '12' for the VoIP telephone.
- A SIP provider account.

#### Using the information during configuration

The following table provides a summary of the information required for configuration and where it can be entered. SIP terminal equipment parameters can be entered using the SIP telephone keypad, the corresponding configuration software, or the softphone configuration menu.

	LANCOM	SIP terminal equipment
Internal VoIP domain	4	4
Internal numbers	4	4
External SIP telephone number	4	
Access information for SIP account	4	
External ISDN telephone numbers (MSNs)	4	
Country and local area code	4	

#### Configuring the LANCOM

When configuring the LANCOM, the following steps must be carried out:

- Set up the line to the SIP provider
- Enabling the ISDN interface and assigning MSNs to the internal numbers

- ! In this example, it is not necessary to configure SIP users: The SIP users are registered at the LANCOM with the settings created in the terminal equipment (softphone and VoIP telephone).

Detailed instructions on configuring the LANCOM:

- Under LANconfig, start the setup wizard for configuring the VoIP Call Manager. Enable the options 'SIP phone system', 'ISDN phone system' and 'ISDN users'.

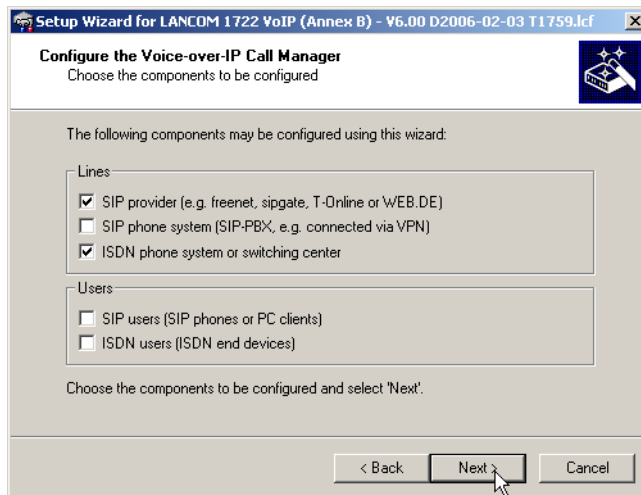

- Enter a unique domain for the local VoIP domain which describes the local VoIP range for the site (e.g. 'mycompany.internal'.)
- Configure the line leading to the SIP provider, for example with the name 'SIPPROVIDER' with the following values:
  - Internal standard number: All calls that come in through the SIP provider are forwarded to this internal number. Enter an internal number from your dialing plan here, e.g. '11'.
  - SIP domain/realm: You received this domain from your SIP provider; it is usually entered in the format 'sipdomain.tld' without the part that designates a specific server.
  - Registrar (FQDN / IP) (optional):
  - Outbound proxy (optional)

- ! The server description is generally not required; the DNS query for the SIP domain returns this information. Enter a server designation here only if your provider has informed you of the corresponding addresses.

- SIP ID / user: Enter the SIP number with local area code here, providing that the SIP provider does not require any other information.
- Display name (optional): The display name is only required if the SIP provider verifies this during registration. If you enter a display name here, then this name will be displayed at the remote site. If the field remains empty, then the display name for the corresponding internal user is transmitted.
- Authentication name (optional): Special authentication names are not supported by all SIP providers. In many cases, the authentication name is the same as the SIP ID or the user name. Complete this field only if your SIP provider has issued you a special authentication name.
- Password: Enter the password for SIP access here.

- ! This description applies to a "user-defined configuration". If you select a special SIP provider from the list, then some of the parameters will be pre-configured automatically.

- Configure an ISDN line for VoIP telephony use. For every MSN on your ISDN connection, make an assignment to an internal number within your telephone number plan during ISDN mapping.
  - MSN 1 '555 555 1' / internal number '11'
  - MSN 2 '555 555 2' / internal number '12'

## 15 Voice over IP (VoIP)

5. Enter the local and national area code for the device's location. Using this information, the Voice Call Manager can decide whether or not outgoing calls are local calls, national or international long distance calls.
6. Based upon the entries made so far, the LANconfig creates a suggestion for the call routing table which you can adapt to fit your requirements as follows:

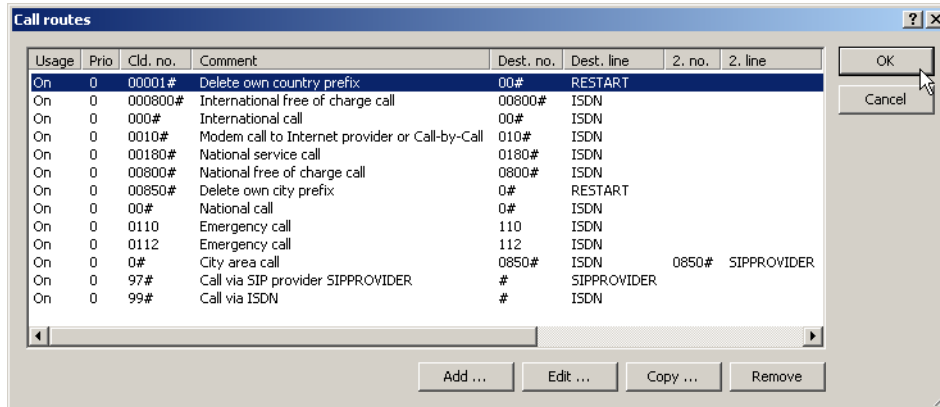

Usage	Prio	Cld. no.	Comment	Dest. no.	Dest. line	2. no.	2. line
On	0	00001#	Delete own country prefix	00#	RESTART		
On	0	000800#	International free of charge call	00800#	ISDN		
On	0	000#	International call	00#	ISDN		
On	0	0010#	Modem call to Internet provider or Call-by-Call	010#	ISDN		
On	0	00180#	National service call	0180#	ISDN		
On	0	00800#	National free of charge call	0800#	ISDN		
On	0	00850#	Delete own city prefix	0#	RESTART		
On	0	00#	National call	0#	ISDN		
On	0	0110	Emergency call	110	ISDN		
On	0	0112	Emergency call	112	ISDN		
On	0	0#	City area call	0850#	ISDN	0850#	SIPPROVIDER
On	0	97#	Call via SIP provider SIPPROVIDER	#	SIPPROVIDER		
On	0	99#	Call via ISDN	#	ISDN		

! The # sign is a placeholder for any character string. The entry '0#' is therefore suitable for all numbers dialed that have at least one '0' preceding them.

This suggested call routing table would place all external calls over the ISDN line. The SIP line is set up as a backup for international and national long distance calls and local calls that are not in the list of special or emergency numbers.

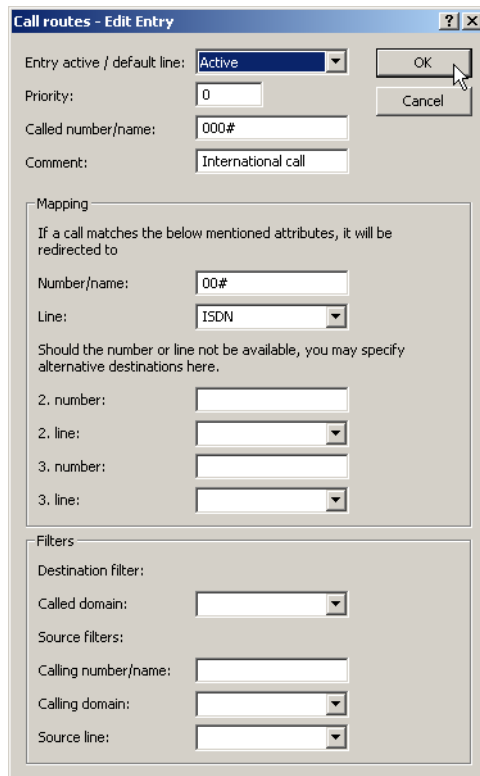

Call routes - Edit Entry

Entry active / default line: Active

Priority: 0

Called number/name: 000#

Comment: International call

Mapping

If a call matches the below mentioned attributes, it will be redirected to

Number/name: 00#

Line: ISDN

Should the number or line not be available, you may specify alternative destinations here.

2. number:

2. line:

3. number:

3. line:

Filters

Destination filter:

Called domain:

Source filters:

Calling number/name:

Calling domain:

Source line:

In order to channel calls to special destinations, such as international and national long distance calls, over the SIP provider, double-click on the corresponding entry in the table and switch the line used from 'ISDN' to 'SIPPROVIDER'. Don't forget to switch the backup line from SIP to ISDN, if necessary!

After being adapted for international and national long distance, the call routing table should appear as follows:

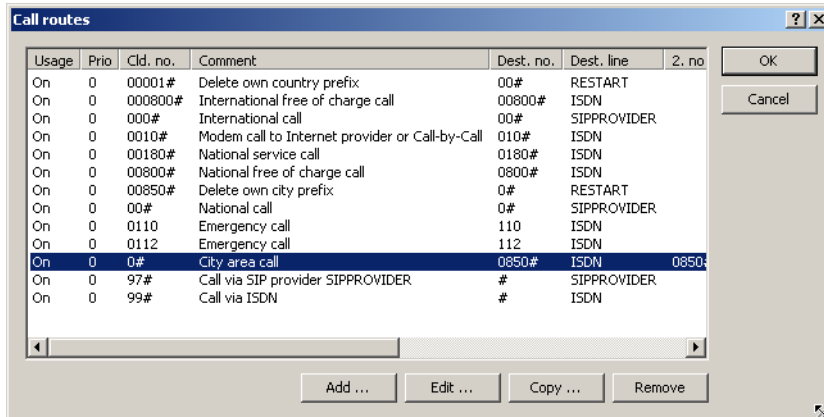

Usage	Prio	Cld. no.	Comment	Dest. no.	Dest. line	2. no
On	0	00001#	Delete own country prefix	00#	RESTART	
On	0	000800#	International free of charge call	00800#	ISDN	
On	0	000#	International call	00#	SIPPROVIDER	
On	0	0010#	Modem call to Internet provider or Call-by-Call	010#	ISDN	
On	0	00180#	National service call	0180#	ISDN	
On	0	00800#	National free of charge call	0800#	ISDN	
On	0	00850#	Delete own city prefix	0#	RESTART	
On	0	00#	National call	0#	SIPPROVIDER	
On	0	0110	Emergency call	110	ISDN	
On	0	0112	Emergency call	112	ISDN	
On	0	0#	City area call	0850#	ISDN	0850#
On	0	97#	Call via SIP provider SIPPROVIDER	#	SIPPROVIDER	
On	0	99#	Call via ISDN	#	ISDN	

## Configuring the VoIP terminal equipment

Enter the registration information for the first SIP user in the softphone (example for LANCOM Advanced VPN Client).

### Defining the SIP account in the LANCOM Advanced VPN Client to register at the LANCOM VoIP Router or at a PBX

Enter the registration information for the first SIP user in the LANCOM Advanced VPN Client.

1. On the 'SIP accounts' tab, use the **Add** button to create a new SIP account.
2. For the provider setting, leave the entry as 'Custom' and activate the new account.

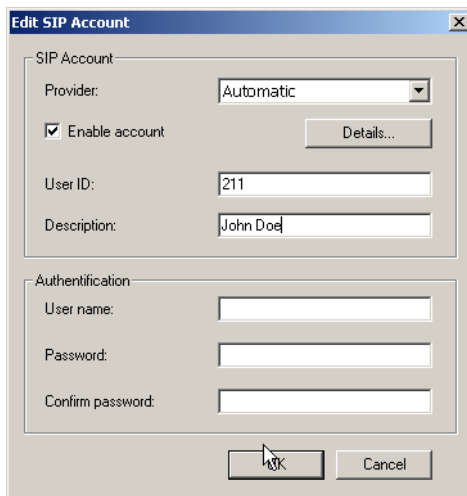

**Edit SIP Account**

SIP Account

Provider: Automatic

Enable account Details...

User ID: 211

Description: John Doe

Authentication

User name:

Password:

Confirm password:

OK Cancel

1. For the 'User ID' enter the internal telephone number to be used by LANCOM Advanced VPN Client for taking calls and, optionally, enter a name for your phone under 'Description'; this name will be displayed on the other phone at the other end of the connection.

2. With the button **Details**, open the dialog for the advanced settings and enter the following data:

SIP Provider Settings

Enter the parameters you got from your provider. At least the SIP Proxy address must be specified.

	Server name:	Port:
SIP Proxy:	internal	5060
Registrar:	internal	5060
Realm:	internal	
STUN server:		3478
DTMF mode:	None	

OK Cancel

1. As the 'SIP proxy' and 'Registrar', enter the internal VoIP domain for your LANCOM VoIP Router (default: 'internal') if this also acts as the DNS server for the client; if not, enter the LAN IP address.
  - 'Realm' is always the internal VoIP domain.



With this information, the LANCOM Advanced VPN Client can register locally at a LANCOM VoIP Router and use the telephone lines defined there.

2. If the LANCOM Advanced VPN Client is to registering not only with the LANCOM VoIP Router locally, but an upstream SIP PBX (e.g. at Headquarters) as well, then enter under 'SIP proxy', 'Registrar' and, under 'Realm', enter the VoIP domain of the SIP PBX at Headquarters. On the LANCOM VoIP Router, an appropriate SIP-PBX line has to be configured with the same domain, and the router has to be the DNS server for the LANCOM Advanced VPN Client.

SIP Provider Settings

Enter the parameters you got from your provider. At least the SIP Proxy address must be specified.

	Server name:	Port:
SIP Proxy:	headquarters.voip	5060
Registrar:	headquarters.voip	5060
Realm:	headquarters.voip	
STUN server:		3478
DTMF mode:	None	

OK Cancel

1. Enter the SIP-account user name and password for logging in to the SIP PBX.

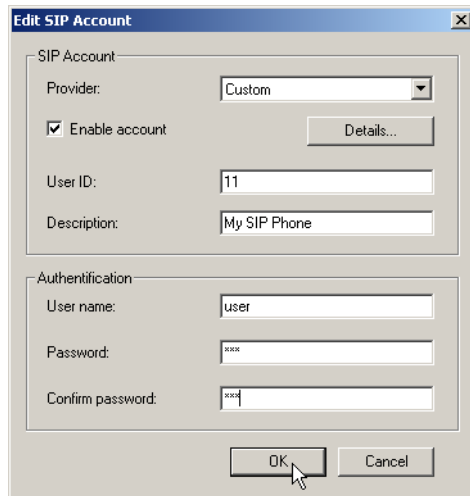

1. You can check if the registration was successful by looking at the list of recent messages (via button or menu).

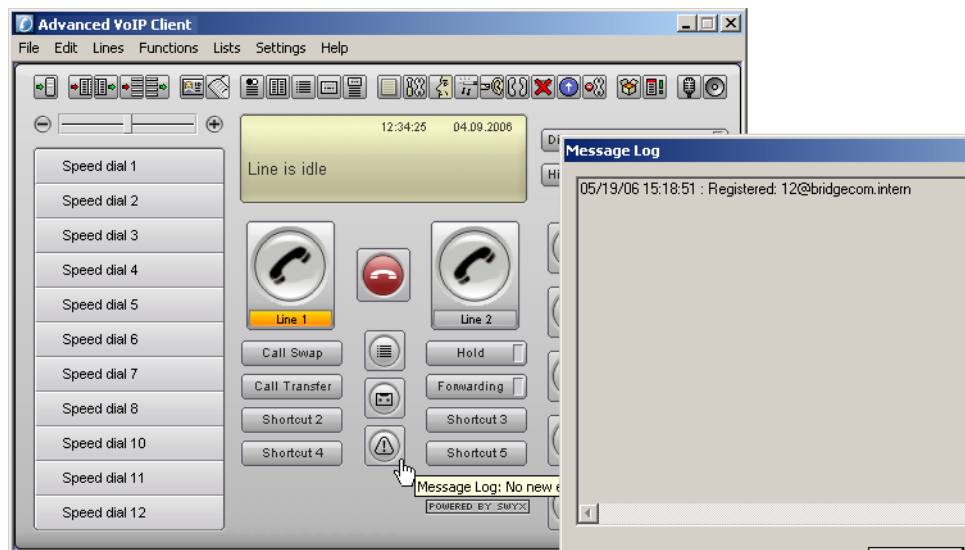

- ! On the tab 'Location' enter your international country code and local code, each without their leading zero(s), and enter the national and international prefixes (e.g. '0' and '00'). The field 'Public line access prefix' is for the character your PBX or LANCOM VoIP Router uses to access an outside line (e.g. '0' or '\*').

Enter the registration data for the second SIP user in the VoIP telephone (example for Snom 190).

1. From the **Setup** menu, select one of the possible lines, e.g. 'Line 2'.

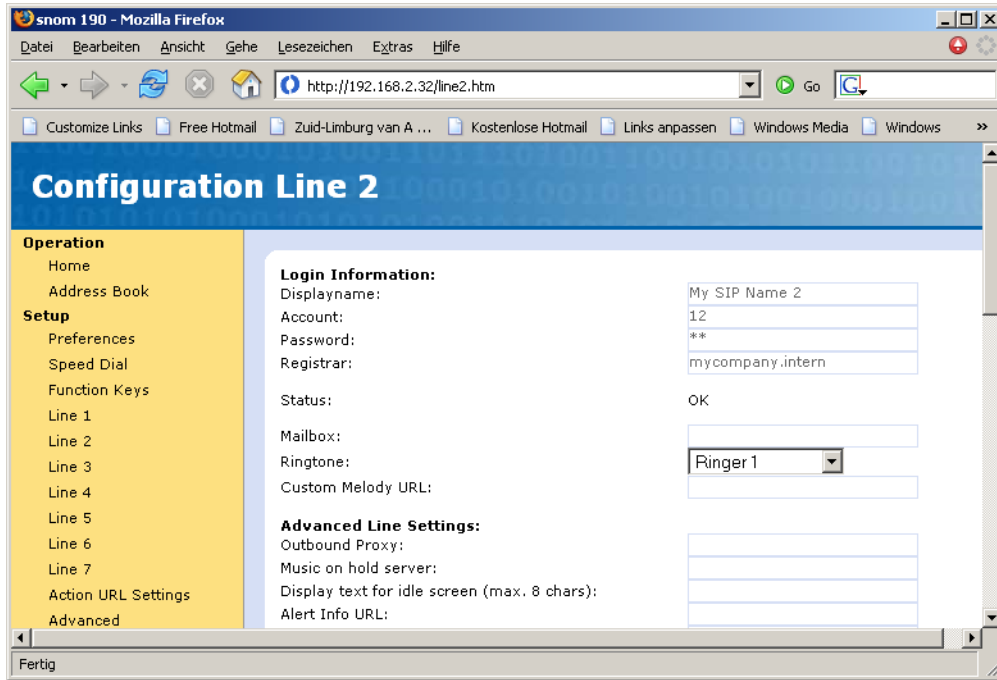

1. Enter the following values:
  - Registrar: Internal VoIP domain for the LANCOM.
  - Account: Internal number for the user.
  - Displayname: Name of the user as it is to be displayed at the remote site.

! If you use another softphone or VoIP telephone, please consult the documentation for this device for information on configuring the software.

### Call routing procedure on outgoing calls

On outgoing calls, the Call Manager first searches the call routing table from top to bottom. If the Call Router cannot find a matching entry there, it uses the list of registered users:

User	dials	correct call route	correct user	mapping, number in use	Destination line in use
VoIP telephone	11	None	VoIP softphone	11	Internal
VoIP telephone	0 555 555	0#		0241#: 0241 555 555	ISDN
VoIP telephone	0 0123 666 666	00#		0#: 0123 666 666	SIP provider

1. The Call Router cannot find a an entry that corresponds to '11' in the call routing table. Now it searches the list of registered users and finds the internal SIP user there.

For call routing, not just the users configured in the LANCOM, but all of the users that are actually registered on the Call Router are used. The SIP users can register themselves as long as they are not entered in the in the LANCOM. The entry for the internal VoIP domain on the LANCOM is sufficient for registration, assuming that local authentication is not required.

1. The entry in the call routing table depicted above matches the number dialed. The call router removes the '0' outside-line access prefix, completes the area code for the local telephone network and completes the call to '0241 555 555' using the ISDN line.



The area code for the local telephone network is added on because calls via SIP providers usually require the area code to be dialed.

1. The entry in the call routing table is suitable here. The call router removes the '0' prefix for access to the outside line and completes the call to '0123 555 555' via the SIP line. If the SIP line is not available, then the call is made over the ISDN line.

### Call routing procedure on incoming calls

For incoming calls, the telephone network exchange removes the prefix from the number dialed (destination number). Therefore, the LANCOM only receives the number itself, which may be treated differently depending on the source:

- Numbers from the ISDN network are translated with the ISDN mapping table to the internal number which is entered for the receiving MSN.
- Calls from a SIP network are converted to the internal destination number that is entered for the respective SIP line.

With the altered number, the Call Manager begins to search the call routing table from top to bottom. If the Call Router cannot find a matching entry there, the call is forwarded directly to the internal number:

Remote site dials	Call router receives	Assigned via	number in use	correct call route	Destination line
0 123 456 789	456 789	internal destination number for SIP line	11	None	Internal
0 123 555 555 1	555 555 1	ISDN mapping	11	None	Internal
0 123 555 555 2	555 555 2	ISDN mapping	12	None	Internal

## 15.13.2 Using VoIP telephony to extend the upstream ISDN PBX

This example shows how to configure a LANCOM when an upstream ISDN PBX is enhanced with VoIP telephony capability. Until now, the MSNs '11' to '13' for the ISDN connection have been used for two ISDN telephones and one analog fax.

 The PBX is configured so that subscribers dial '0' to access an outside line.

The LANCOM is operated on an ISDN PBX extension line.

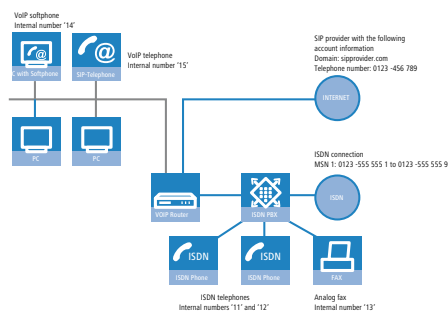

### Destination

- Internal telephony with ISDN and SIP telephones and SIP softphones.
- External telephony with VoIP terminal equipment via the SIP provider with backup over ISDN.
- External telephony with ISDN terminal equipment in the PBX. Depending on the functionality of the ISDN PBX, ISDN terminal equipment can also use the SIP lines in the LANCOM VoIP Router.
- Accessing internal terminal equipment (ISDN and SIP) via the MSNs.
- Calls to emergency and special numbers via ISDN.

## Requirements

- LANCOM connected to the LAN and WAN, an ISDN TE interface is linked to the extension interface on the ISDN PBX. The Internet connection has been set up.
- A dialing plan with a unique internal telephone number for each piece of terminal equipment to be connected. In general, the numbers used are predetermined by the PBX, which often only allows certain number ranges.
- A SIP provider account.

## Using the information during configuration

### Dialing plans with ISDN PBX systems.

When crossing from the ISDN network to the internal subscribers, the ISDN PBX converts the external MSNs to internal MSNs. When operating a LANCOM VoIP Router at the extension interface of the ISDN PBX, there is another conversion of the internal MSNs to the internal numbers of the VoIP range. For reasons of clarity, we recommend using congruent internal MSNs/numbers for terminal equipment for all connections.

The following table provides a summary of the information required for configuration and where it can be entered. SIP terminal equipment parameters can be entered using the SIP telephone keypad, the corresponding configuration software, or the softphone configuration menu.

	LANCOM	SIP terminal equipment	ISDN PBX	ISDN terminal equipment
Internal VoIP domain	4	4		
Internal numbers	4	4	4	4
External SIP telephone number	4			
Access information for SIP account	4			
External ISDN telephone numbers (MSNs)			4	
Country and local area code	4			

## Configuring the LANCOM

When configuring the LANCOM, the following steps must be carried out:

- Set up the line to the SIP provider
- Enabling the ISDN interface and assigning internal MSNs in the PBX to the internal numbers of the LANCOM VoIP Router
- Adapt the call routing table



In this example, it is not necessary to configure SIP or ISDN users:

- The SIP users are registered at the LANCOM with the settings created in the terminal equipment (softphone and VoIP telephone).
  - The ISDN devices can be reached via a corresponding entry in the call routing table.

Detailed instructions on configuring the LANCOM:

- Under LANconfig, start the setup wizard for configuring the VoIP Call Manager. Enable the options 'SIP phone system', 'ISDN phone system' and 'ISDN users'.

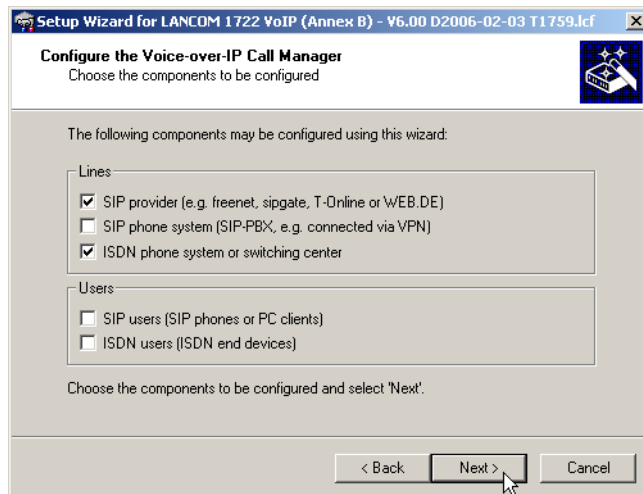

- Configure the device as described in the preceding examples:
  - Unique local VoIP domains
  - one line to a SIP provider
  - ISDN line
- Adapt the suggested call routing table in order to direct calls to special numbers automatically over the SIP provider's line. The following example shows the entry for international calls.

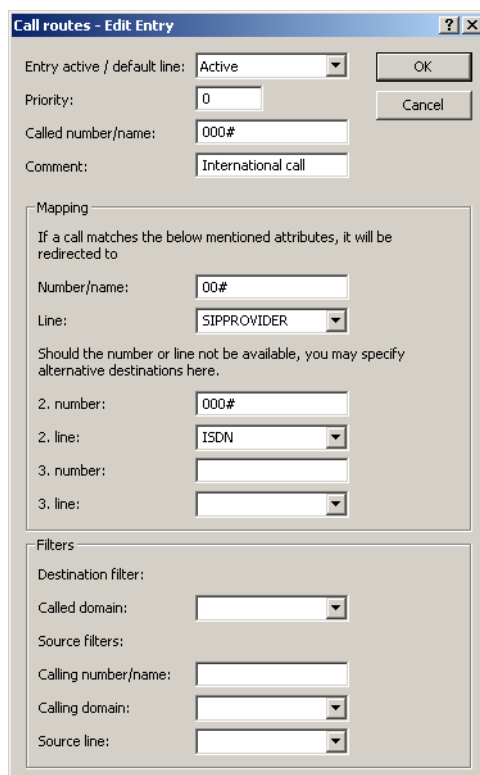

1. After being adapted, the call routing table should appear as follows:

Usage	Prio	Cld. no.	Comment	Dest. no.	Dest. line
On	0	00001#	Delete own country prefix	00#	RESTART
On	0	000800#	International free of charge call	00800#	ISDN
On	0	000#	International call	00#	SIPPROVIDER
On	0	0010#	Modem call to Internet provider or Call-by-Call	010#	ISDN
On	0	00180#	National service call	0180#	ISDN
On	0	00800#	National free of charge call	0800#	ISDN
On	0	00850#	Delete own city prefix	0#	RESTART
On	0	00#	National call	0#	SIPPROVIDER
On	0	0110	Emergency call	110	ISDN
On	0	0112	Emergency call	112	ISDN
On	0	0#	City area call	0850#	ISDN
On	0	97#	Call via SIP provider SIPPROVIDER	#	SIPPROVIDER
On	0	99#	Call via ISDN	#	ISDN

Therefore, for every long distance call, the '0' preceding the number is removed, the call is made via the SIP provider.

2. For all ISDN calls, however, the '0' may not be removed from the destination number because the upstream ISDN PBX requires the '0' to access an outside line! Therefore, adapt the destination number for all entries with the target line 'ISDN'.

After being adapted, the call routing table should appear as follows:

Usage	Prio	Cld. no.	Comment	Dest. no.	Dest. line
On	0	00001#	Delete own country prefix	00#	RESTART
On	0	000800#	International free of charge call	000800#	ISDN
On	0	000#	International call	00#	SIPPROVIDER
On	0	0010#	Modem call to Internet provider or Call-by-Call	0010#	ISDN
On	0	00180#	National service call	00180#	ISDN
On	0	00800#	National free of charge call	00800#	ISDN
On	0	00850#	Delete own city prefix	0#	RESTART
On	0	00#	National call	0#	SIPPROVIDER
On	0	0110	Emergency call	0110	ISDN
On	0	0112	Emergency call	0112	ISDN
On	0	0#	City area call	00850#	ISDN
On	0	97#	Call via SIP provider SIPPROVIDER	#	SIPPROVIDER
On	0	99#	Call via ISDN	#	ISDN

3. In order to allow the ISDN subscribers to be contacted internally by the VoIP users, a standard route is also set up which directs all calls that have not yet been resolved to the ISDN line without changing the numbers.

After being adapted, the call routing table should appear as follows:

Usage	Prio	Cld. no.	Comment	Dest. no.	Dest. line	2. no.	2. line
On	1	*#	Escape code '*' for local call	#	RESTART		
On	1	#	User initiates normal external call	0#	RESTART		
On	0	00001#	Delete own country prefix	00#	RESTART		
On	0	000800#	International free of charge call	00800#	ISDN		
On	0	000#	International call	00#	SIPGATE		
On	0	0010#	Modem call to Internet provider or Call-by-Call	010#	ISDN		
On	0	00180#	National service call	0180#	ISDN		
On	0	00800#	National free of charge call	0800#	ISDN		
On	0	00850#	Delete own city prefix	0#	RESTART		
On	0	00#	National call	0#	SIPGATE		
On	0	0110	Emergency call	110	ISDN		
On	0	0112	Emergency call	112	ISDN		
On	0	0#	City area call	0850#	ISDN	0850#	SIPGATE
On	0	97#	Call via SIP provider WIZ_SIPGATE	#	SIPGATE		
On	0	99#	Call via ISDN	#	ISDN		
Default	0	#		#	ISDN		

 This call routing table is only valid for PBX systems in which the subscribers have to dial '0' to access an outside line. If the PBX uses another mechanism for accessing an outside line, then the table must be adapted accordingly.

## Configuring the VoIP terminal equipment

The VoIP terminal equipment is configured as described in the preceding examples with internal VoIP domains and internal numbers for the local site.

## Configuring ISDN PBX

When configuring the PBX, external MSNs are assigned to internal MSNs. For every VoIP terminal device, a free internal MSN is linked to an external MSN.

## External and internal calls from ISDN terminal devices into VoIP telephony

First, the ISDN terminal devices forward the desired destination number to the ISDN PBX when the call is being established. If the number is an internal number/MSN, then the PBX directs the call to the internal ISDN bus. The SIP terminal equipment connected to the LANCOM can therefore only be reached via an internal call when the PBX knows the internal number for the VoIP user.

If your PBX is able to direct external numbers to the internal ISDN bus, then the ISDN terminal devices can also use the lines configured in the LANCOM, such as the SIP provider line, for outgoing external calls.

## Configuring the ISDN terminal equipment

Configuring the ISDN terminal equipment is generally limited to entering the internal MSN used in the PBX.

## Call routing procedure on outgoing calls

User	dials	correct call route	correct user	mapping, number in use	Destination line
VoIP telephone	14	None	VoIP softphone	14	Internal
VoIP telephone	11	# (Standard)		#: 11	ISDN
ISDN telephone	14	1. PBX	VoIP softphone	14	Internal
VoIP telephone	0 555 555	0#		00241#: 0 555 555	ISDN
ISDN telephone	0 555 555	1. PBX		555 555	ISDN outside line
VoIP telephone	0 0123 666 666	00#		0#: 0123 666 666	SIP provider

1. Internal call between two VoIP terminal devices.
2. Internal call from VoIP to ISDN. In the first pass (without the standard routes), the number '11' does not match any of the routes. Similarly, no matching entry can be found in the list of registered users. In the second pass, the standard route meets '#' (entry in the call routing table depicted above) and directs the call to the ISDN line **unchanged**. The PBX receives the call on its internal ISDN bus, recognizes the called number as an internal MSN and again forwards the call to the internal ISDN bus to which the respective ISDN terminal device is connected.
3. Internal call from ISDN to VoIP. The ISDN PBX recognizes the destination number '14' as an internal MSN and directs the call to the corresponding internal ISDN bus. The Call Router receives the call to '14', does not find a matching entry in the call routing table but does find an entry in the list of registered users.
4. External call from the VoIP into the local telephone network. The entry in the call routing table depicted above matches the number dialed. The Call Router completes the area code for the local telephone network and sends the call out to the ISDN line. Only now does the SIP PBX removes the '0' outside-line access prefix and completes the call to '0241 555 555' via the ISDN outside line.

## 15 Voice over IP (VoIP)

5. External call from ISDN into the local telephone network. The ISDN PBX recognizes the destination number as an external destination, removes the '0' outside-line access prefix and completes the call to '555 555' via the ISDN outside line.
6. External call from VoIP into the national telephone network. The entry fits in the call routing table here. The call router removes the '0' prefix for access to the outside line and completes the call to '0123 555 555' via the SIP line. If the SIP line is not available, then the call is made over the ISDN line. In this case, the '0' is not removed from the destination number in order to gain access to an outside line through the PBX.

## Call routing procedure on incoming calls

Remote site dials	Call router receives	Assigned via	number in use	correct call route	Destination line
0 123 456 789	456 789	internal destination number for SIP line	11	None	ISDN
0 123 555 555 1		ISDN PBX	11		Internal
0 123 555 555 4	14	<ol style="list-style-type: none"> <li>1. ISDN PBX</li> <li>2. List of local users</li> </ol>	14	None	Internal

1. The incoming call for the SIP line number is directed to the Call Router along with the internal destination number that has been configured. The Call Router cannot find a matching entry in the call routing table, but it can find a registered user with the matching internal number. Since the user is an ISDN user, the Call Router directs the call to the ISDN line. The PBX receives the number '11' and can determine this call to be an internal call for the connected ISDN telephone.
2. The incoming calls to the MSNs for the connected ISDN terminal equipment can be assigned directly by the PBX itself, the Call Router is not involved here.
3. The PBX directs incoming calls to the MSNs for the connected VoIP terminal equipment to the internal ISDN bus with the internal MSN. The Call Router receives these calls as if they were internal calls and forwards them to the appropriate user since no corresponding entry can be found in the call routing table here either.

## 15.13.3 Using VoIP telephony to extend the downstream ISDN PBX

This example shows how to configure a LANCOM when a downstream ISDN PBX is enhanced with VoIP telephony capability. Until now, the MSNs '11' to '13' for the ISDN connection have been used for two ISDN telephones and one analog fax. The LANCOM will now be switched between the public ISDN connection and the ISDN PBX.

 The PBX is configured to allow subscribers to receive immediate access to an outside line when they pick up the receiver.

This ISDN PBX is operated as a downstream PBX on the ISDN NT interface of the LANCOM.

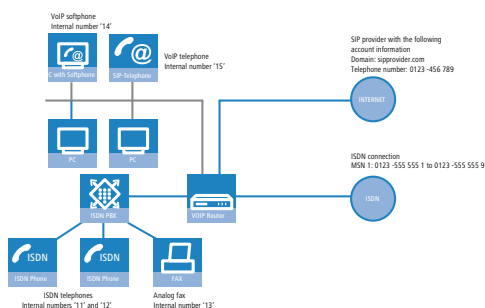

## Destination

- Internal telephony with ISDN and SIP telephones and SIP softphones.
- External telephony with ISDN and SIP terminal equipment over ISDN.

- Accessing internal terminal equipment (ISDN and SIP) via the MSNs.

## Requirements

- LANCOM connected to the LAN and WAN, an ISDN NT interface is linked to the outside exchange line on the ISDN PBX. The Internet connection has been set up.
- A dialing plan with a unique internal telephone number for each piece of terminal equipment to be connected. In general, the numbers used are predetermined by the PBX, which often only allows certain number ranges.
- A SIP provider account.

## Using the information during configuration

### Dialing plans with ISDN PBX systems.

When crossing from the ISDN network to the internal subscribers, the ISDN PBX converts the external MSNs to internal MSNs. When operating a LANCOM VoIP Router at the extension interface of the ISDN PBX, there is another conversion of the internal MSNs to the internal numbers of the VoIP range. For reasons of clarity, we recommend using congruent internal MSNs/numbers for terminal equipment for all connections.

The following table provides a summary of the information required for configuration and where it can be entered. SIP terminal equipment parameters can be entered using the SIP telephone keypad, the corresponding configuration software, or the softphone configuration menu.

	LANCOM	SIP terminal equipment	ISDN PBX	ISDN terminal equipment
Internal VoIP domain	4	4		
Internal numbers	4	4	4	4
External SIP telephone number	4			
Access information for SIP account	4			
External ISDN telephone numbers (MSNs)	4			
Country and local area code	4			

### Configuring the LANCOM

When configuring the LANCOM, the following steps must be carried out:

- Set up the line to the SIP provider
- Enabling the ISDN interface and assigning MSNs to the internal numbers in the LANCOM VoIP Router
- Creating ISDN users
- Adapt the call routing table

Detailed instructions on configuring the LANCOM:

1. Under LANconfig, start the setup wizard for configuring the VoIP Call Manager. Enable the options 'SIP provider', 'ISDN phone system' and 'ISDN users'.

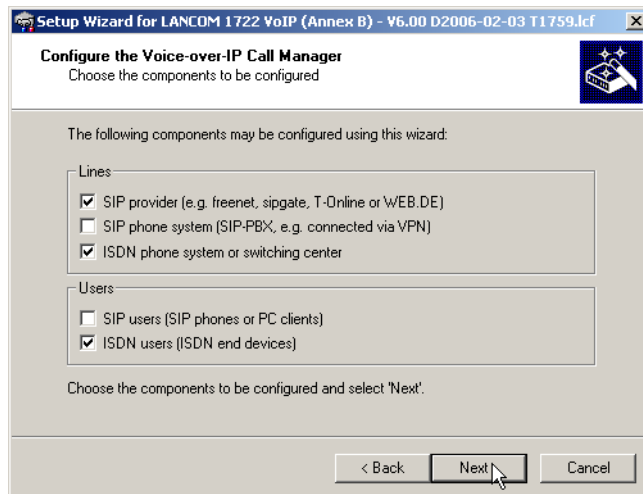

1. Configure the device as described in the preceding examples:
  - Unique local VoIP domains
  - one line to a SIP provider
2. Enable the external ISDN outside line and the internal ISDN bus in order to use the VoIP functionality. Enter all external MSNs for the ISDN outside line in the ISDN mapping table with their assignment to the internal numbers in the VoIP range.
3. Enter all connected ISDN terminal devices as ISDN users with the following values:
  - Telephone number / SIP name: This number will be assigned to the ISDN terminal device as an "internal number". The telephone structure will remain clear if you use the same internal number for a terminal device here as it uses in its own ISDN environment.
  - MSN/DDI: Enter the external MSNs for the ISDN outside line here; this will also be assigned to the terminal device by the ISDN PBX.
4. Enable spontaneous outside line access for ISDN and SIP users in order to keep the subscribers' telephone behavior as consistent as possible.
5. The call routing table suggested by the setup wizard automatically allows spontaneous outside line access for ISDN and SIP users and .

### Routes for spontaneous outside line access

Entering the source line 'USER' is not visible in the screenshot. Using this filter, the route will only be in effect for calls that originate from a local user. The destination line 'RESTART' prompts a new pass through the call routing table, whereby the source line is deleted. Due to the missing source line, the route does not match this call during the second pass.



- As a result of both of these routes, any stars '\*' that might have preceded the numbers are removed before each call from a local user. For all other calls from local users, the number is preceded with a '0', as it is automatically assumed that the user is trying to establish an outside connection.

Usage	Prio	Cld. no.	Comment	Dest. no.	Dest. line	2. no.	2. line
On	1	*#	Escape code '*' for local call	#	RESTART		
On	1	#	User initiates normal external call	0#	RESTART		
On	0	00001#	Delete own country prefix	00#	RESTART		
On	0	000800#	International free of charge call	00800#	ISDN		
On	0	000#	International call	00#	ISDN		
On	0	0010#	Modem call to Internet provider or Call-by-Call	010#	ISDN		
On	0	00180#	National service call	0180#	ISDN		
On	0	00800#	National free of charge call	0800#	ISDN		
On	0	00850#	Delete own city prefix	0#	RESTART		
On	0	00#	National call	0#	ISDN		
On	0	0110	Emergency call	110	ISDN		
On	0	0112	Emergency call	112	ISDN		
On	0	0#	City area call	0850#	ISDN	0850#	SIPGATE
On	0	97#	Call via SIP provider WIZ_SIPGATE	#	SIPGATE		
On	0	99#	Call via ISDN	#	ISDN		

The other routes are used to carry out international and national long distance calls as well as local calls as standard over the ISDN line. The Call Router removes the preceding zeros from the number again and sends the call out to the ISDN line.

In order to channel calls to special destinations, such as international and national long distance calls, over the SIP provider and not over ISDN, double-click on the corresponding entry in the table and switch the line used from 'ISDN' to 'SIPPROVIDER'. Don't forget to switch the backup line from SIP to ISDN, if necessary!

Usage	Prio	Cld. no.	Comment	Dest. no.	Dest. line	2. no.	2. line
On	1	*#	Escape code '*' for local call	#	RESTART		
On	1	#	User initiates normal external call	0#	RESTART		
On	0	00001#	Delete own country prefix	00#	RESTART		
On	0	000800#	International free of charge call	00800#	ISDN		
On	0	000#	International call	00#	SIPGATE		
On	0	0010#	Modem call to Internet provider or Call-by-Call	010#	ISDN		
On	0	00180#	National service call	0180#	ISDN		
On	0	00800#	National free of charge call	0800#	ISDN		
On	0	00850#	Delete own city prefix	0#	RESTART		
On	0	00#	National call	0#	SIPGATE		
On	0	0110	Emergency call	110	ISDN		
On	0	0112	Emergency call	112	ISDN		
On	0	0#	City area call	0850#	ISDN	0850#	SIPGATE
On	0	97#	Call via SIP provider WIZ_SIPGATE	#	SIPGATE		
On	0	99#	Call via ISDN	#	ISDN		
Default		#		#	ISDN		

! This call routing table is only valid for PBX systems that forward the special character star '\*' for internal calls on their external ISDN bus. If the PBX processes this character in a different manner, then the table must be adapted accordingly.

## Configuring the VoIP terminal equipment

The VoIP terminal equipment is configured as described in the preceding examples with internal VoIP domains and internal numbers for the local site.

## Configuring ISDN PBX

When configuring the PBX, external MSNs are assigned to internal MSNs. For every VoIP terminal device, a free internal MSN is linked to an external MSN. The internal number for the SIP user can be used as an external MSN for the VoIP terminal equipment in the PBX.

## Configuring the ISDN terminal equipment

Configuring the ISDN terminal equipment is generally limited to entering the internal MSN used in the PBX.

### Call routing procedure on outgoing calls

User	dials	correct call route	correct user	mapping, number in use	Destination line
VoIP telephone	*14	*#	VoIP softphone	#: 14	Internal
VoIP telephone	*11	*#	ISDN users	#: 11	ISDN

1. Internal call between two VoIP terminal devices. On the first pass, only the star is removed from the number, the source line is deleted. During the second pass, no other route matches this call but the Call Router finds a matching entry for a SIP user in the list of registered users and can complete the call.
2. Internal call from VoIP to ISDN. On the first pass, the star is removed from the number again, the source line is deleted. During the second pass, no other route matches this call but the Call Router finds a matching entry for an ISDN user in the list of registered users and establishes the call via the ISDN interface configured for this user. The destination number is replaced by the MSN entered for this user '555 555 1'. The PBX receives the call to '555 555 1' on its external ISDN bus and again determines that this is an external MSN and can channel the call to the corresponding ISDN telephone.

### Call routing procedure on incoming calls

Remote site dials	Call router receives	Assigned via	number in use	correct call route	Destination line
0 123 555 555 1	555 555 1	1. ISDN mapping table 2. List of local ISDN users	11		ISDN NT

1. The incoming call via the number to the MSNs for the connected ISDN terminal equipment is converted into an internal number by the ISDN mapping table and passed on to the Call Router. The Call Router cannot find a matching entry in the call routing table, but it can find a registered user with the matching internal number. Since the user is an ISDN user, the Call Router directs the call to the ISDN line with the MSN entered for this user, '555 555 1'. The PBX receives the call to '555 555 1' on its external ISDN bus and again determines that this is an external MSN and can channel the call to the corresponding ISDN telephone.

## 15.13.4 Using VoIP telephony to supplement existing ISDN telephones

This example shows how to configure a LANCOM when the ISDN telephones used unit now are to be enhanced with VoIP telephony. The external MSNs '555 555 1' and '555 555 2' on the ISDN bus at the NTBA were used for two ISDN telephones until now. The LANCOM will now be switched between the public ISDN connection and the internal ISDN bus connected to the ISDN telephones.

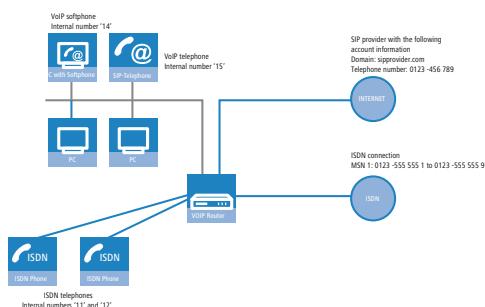

## Destination

- Internal telephony with ISDN and SIP telephones and SIP softphones.
- External telephony with ISDN and SIP terminal equipment over ISDN.
- Accessing internal terminal equipment (ISDN and SIP) via the MSNs.

## Requirements

- LANCOM connected to LAN and WAN, an ISDN NT interface connected to the ISDN telephone, an ISDN TE interface connected to the ISDN outside line (NTBA). The Internet connection has been set up.
- A dialing plan with a unique internal telephone number for each piece of terminal equipment to be connected.
- A SIP provider account.

## Configuring the LANCOM

When configuring the LANCOM, the following steps must be carried out:

- Set up the line to the SIP provider
- Enabling the ISDN interface and assigning MSNs to the internal numbers in the LANCOM VoIP Router
- Creating ISDN users
- Adapt the call routing table

Detailed instructions on configuring the LANCOM:

1. Under LANconfig, start the setup wizard for configuring the VoIP Call Manager. Enable the options 'SIP provider', 'ISDN phone system' and 'ISDN users'.

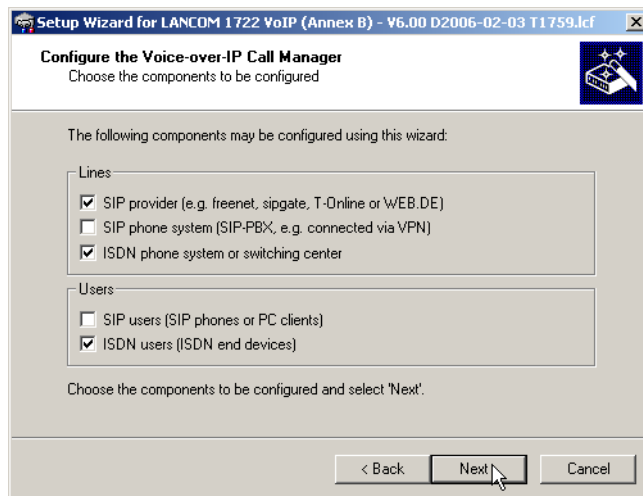

1. Configure the device as described in the preceding examples:
  - Unique local VoIP domains
  - one line to a SIP provider
2. Enable the external ISDN outside line and the internal ISDN bus in order to use the VoIP functionality. Enter all external MSNs for the ISDN outside line in the ISDN mapping table with their assignment to the internal numbers in the VoIP range.
3. Enter all connected ISDN terminal devices as ISDN users with the following values:
  - Telephone number / SIP name: This number will be assigned to the ISDN terminal device as an "internal number". The telephone structure will remain clear if you use the same internal number for a terminal device here as it uses in its own ISDN environment.
  - MSN/DDI: Here, enter the external MSN of the ISDN outside line which was formerly entered into the ISDN telephone.

## Assigning external MSNs to internal telephone numbers

In this example, the external MSNs and the internal telephones will be assigned "crossed over":

- In the ISDN mapping table, the external MSN '555 555 1' is assigned to the internal telephone number '11', for example. An external call to '555 555 1' will be switched by the LANCOM as a call to '11'.
- By assigning the MSN '555 555 1' to the internal telephone number of the ISDN user '11', the call will be directed over the internal ISDN bus of the LANCOM with the target telephone number '555 555 1'.

Because the ISDN telephone "listens" out for its own MSN, exactly as it used to before implementing the LANCOM VoIP Router, the call is placed to the correct telephone.

Should the LANCOM VoIP Router fail due to a power outage, the life-line support and power relay over the ISDN bus, if activated, enable the connected telephones to continue to function.

1. Enable spontaneous outside line access for ISDN and SIP users in order to keep the subscribers' telephone behavior as consistent as possible.
2. The continued configuration and changes to the call routing table are carried out just as in the example 'Using VoIP telephony to extend the downstream ISDN PBX'.

## Configuring the VoIP terminal equipment

The VoIP terminal equipment is configured as described in the preceding examples with internal VoIP domains and internal numbers for the local site.

## Configuring the ISDN telephones

Configuring the ISDN terminal equipment is generally limited to entering the external MSN. As a rule, the MSNs were already entered into the ISDN telephones before, and so no changes should be necessary.

### 15.13.5 Connecting to an upstream SIP PBX

In this example, a branch office network will be connected to the headquarters network over VPN. In addition to data transfer, the telephone structure in the branch office is also connected to the central SIP PBX. A LANCOM VoIP Router is used in the branch office network and a LANCOM VPN router, for example, could act as the VPN end point at the headquarters. The telephony subscribers at the headquarters receive internal extensions from the number range '101' to '199'; for each of the branch offices, a 10-digit block from the 200 range is reserved - in this example, '211' to '219'.

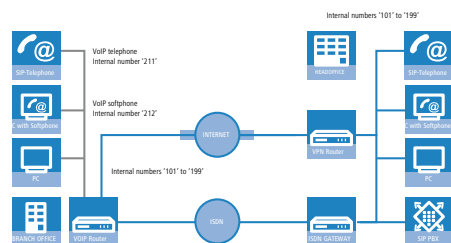

## Destination

- Internal telephony between all locations.
- External telephony from the branch office via the SIP PBX at the headquarters with backup over ISDN.
- Calls from the branch office into the local telephone network via ISDN.
- Calls to emergency and special numbers via ISDN.

## Requirements

- LANCOM connected to the LAN and WAN, an ISDN TE interface is linked to the ISDN NTBA.
- The Internet connection has been set up by means of a VPN tunnel, as has the network connection between the two locations. All terminal devices can contact each other with the IP addresses used.

- A dialing plan with a unique internal telephone number for each piece of terminal equipment to be connected.
- A SIP provider account.

## Configuring the LANCOM

The following table provides a summary of the information required for configuration and where it can be entered. Basically, all that is needed is a SIP PBX line for each location that is correspondingly setup at the remote location

	LANCOM Branch office	SIP terminal equipment Branch office	SIP PBX Headquarters
Internal VoIP domain	mycompany.BRANCH01	mycompany.HQ	mycompany.HQ
Internal SIP subscriber numbers at the branch office		4	4
External ISDN telephone numbers (MSNs)	4		
Country and local area code	4		
SIP PBX line	HQ		
SIP PBX domains	mycompany.HQ		
SIP PBX registration password	4		4
Call route	<ol style="list-style-type: none"> <li>1. Called number '2#'</li> <li>2. Destination line 'LOCATION_B'</li> <li>3. Destination number '2#'</li> </ol>		

Detailed instructions on configuring the LANCOM:

1. Under LANconfig, start the setup wizard for configuring the VoIP Call Manager. Enable the options 'SIP phone system', 'ISDN phone system' and 'ISDN users'.

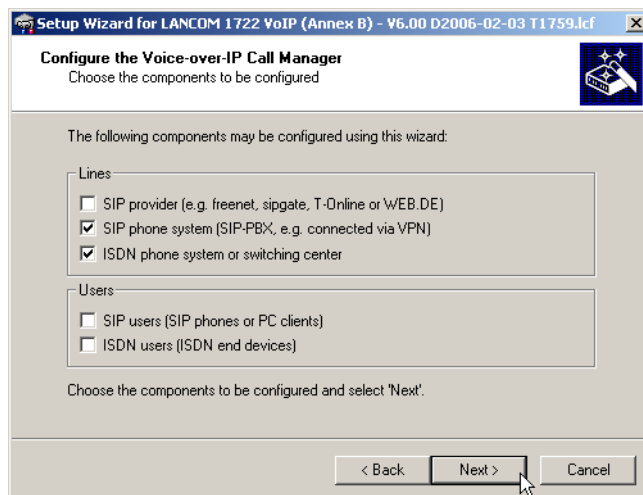

1. Configure the device as described in the preceding examples:
  - ISDN line with MSN mapping
  - Area and country code for each location
2. Enter a unique domain for the local VoIP domain which describes the local VoIP range for the branch office, e.g. 'mycompany.BRANCH01' for the first branch.
3. Configure the line leading to the SIP PBX with the following values:
  - SIP PBX line name: Unique name for the line leading to the SIP PBX, e.g. 'HQ' for "Headquarters".

- PBX SIP domain/realm: Internal VoIP domain or SIP PBX, e.g. 'mycompany.HQ'.
- Registrar (FQDN or IP) (optional): SIP PBX address in the headquarters network, in the event that the device cannot be identified via DNS resolution of the VoIP domain (PBX SIP domain/realm).



Use the SIP PBX IP address from the private IP address range at the headquarters that can be reached via VPN here.

- Outbound proxy (optional): It is generally not necessary to designate the outbound proxy. Only enter a server designation here should the SIP PBX require your corresponding addresses.
- Shared PBX password: This password is used by all SIP users when registering at the SIP PBX.

### Shared or user-dependent SIP PBX password

If registration with a shared password is not desired, then an individual password can be used for each SIP user. In this case, each SIP user is configured with its own password in the LANCOM

1. Public PBX number: Here, enter the number at which the SIP PBX is to be reached over the public telephone network from the location of the LANCOM. The number is entered with the **necessary** prefixes, but without an extension number. For example, if the SIP PBX is located in London and the LANCOM is in Birmingham, then the public PBX number is '020 12345'.
2. The call routing table suggested by the setup wizard automatically allows international and national long distance calls to be made via the SIP PBX at the headquarters.
  - In addition, a **standard route** is used in order to conduct calls from the LANCOM VoIP range to internal SIP PBX numbers via the corresponding SIP PBX lines.



This special entry is only used during the second pass in the call routing table, after the first pass found no corresponding entry for "normal" routes and if no matching internal number was found in the list of local users.

Usage	Prio	Cld. no.	Comment	Dest. no.	Dest. line	2. no.	2.
On	0	00001#	Delete own country prefix	00#	RESTART		
On	0	000800#	International free of charge call	00800#	ISDN		
On	0	000#	International call	000#	HQ		
On	0	0010#	Modem call to Internet provider or Call-by-Call	010#	ISDN		
On	0	00180#	National service call	0180#	ISDN		
On	0	00800#	National free of charge call	0800#	ISDN		
On	0	0085055555#	Reroute to PBX line HQ	#	RESTART		
On	0	00850#	Delete own city prefix	0#	RESTART		
On	0	00#	National call	00#	HQ		
On	0	0110	Emergency call	110	ISDN		
On	0	0112	Emergency call	112	ISDN		
On	0	0#	City area call	0850#	ISDN		
On	0	98#	Call via ISDN	#	ISDN		
On	0	99#	Call via SIP-PBX HQ	0#	HQ		
Default	0	#	Default to SIP-PBX HQ	#	HQ		

### Configuring the VoIP terminal equipment

The VoIP terminal equipment is configured as described in the preceding examples. However, here, the SIP PBX VoIP domain and the internal numbers configured in the SIP PBX are used.

### Automatic SIP user registration with the LANCOM and the SIP PBX.

By using the SIP PBX domain with VoIP terminal equipment, the user is registered in two ways:

- Since registration takes place with a valid domain defined in the LANCOM, terminal devices are registered as "local users".

- Since the domain that is used does not correspond to the LANCOM's own VoIP domain, a simultaneous attempt is made at registering with the upstream SIP PBX. If the password used corresponds to the password stored in the SIP PBX for this user, then the registration on the SIP PBX will be successful.

#### Configuring the SIP PBX

In the SIP PBX, all users from the branch office network are entered with their own internal number. For this purpose, either the shared password is entered or a separate password is assigned for each user.

#### Call routing procedure on outgoing calls

User	dials	correct call route	correct user	mapping, number in use	Destination line
Branch VoIP telephone	212	None	VoIP softphone	212	Internal
Branch VoIP telephone	199	#	SIP subscribers at the headquarters	#: 199	SIP PBX
Branch VoIP telephone	0 555 555	0#		0241#: 0241 555 555	ISDN
Branch VoIP telephone	0 0123 666 666	00#		00#: 0123 666 666	SIP PBX

- Internal call between two VoIP terminal devices at the branch office. The number dialed, '212', does not match any of the routes listed in the call routing table. Therefore, the call router searches the local user list, finds the correct entry there and can forward the call internally.
- Internal call between a VoIP terminal device at the branch office and the internal subscriber '199' at the headquarters. The number dialed, '199', does not match any of the routes listed in the call routing table during the first pass. Similarly, no matching entry can be found in the local user list. In the second pass through the call routing table, the standard routes are considered too. The route with the number called '#' corresponds to all calls which could not be assigned earlier. The call to '199' is therefore carried out over the SIP PBX line.
- External call from the branch office into the local telephone network. The number dialed, '0 555,555', matches the route '0#' in the call routing table. The call router removes the '0' outside-line access prefix, completes the area code for the local telephone network and completes the call to '0241 555 555' using the ISDN line.
- External call from the branch office into a national telephone network. The number dialed, '0 0123 555 555', matches the route '00#' in the call routing table. The call router sends the call out to the SIP PBX line **unchanged**. Only now does the SIP PBX removes the '0' outside-line access prefix and completes the call to '0123 555 555' via the ISDN outside line.

### 15.13.6 VoIP connectivity for locations without a SIP PBX

Companies with widely disperse offices and without their own SIP PBX can also take advantage of VoIP site-to-site connectivity. In this "Peer-to-Peer" scenario, a LANCOM VoIP Router has been implemented at both locations.

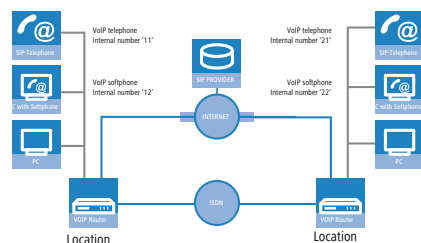

#### Destination

- Internal telephony at and between both locations.
- External telephony via the SIP provider with backup over ISDN.

- Calls to emergency and special numbers via ISDN.

### Requirements

- LANCOM connected to the LAN and WAN, an ISDN TE interface is linked to the ISDN NTBA.
- The Internet connection has been set up by means of a VPN tunnel, as has the network connection between the two locations. All terminal devices can contact each other with the IP addresses used.
- A dialing plan with a unique internal telephone number for each piece of terminal equipment to be connected. For each site, a separate number range is used; in this example, the internal numbers for location A begin with a '1' and the internal numbers for location B begin with a '2'.
- Each site has a SIP provider account.

### Configuring the LANCOM

The following table provides a summary of the information required for configuration and where it can be entered. Basically, all that is needed is a SIP PBX line for each location that is correspondingly setup at the remote location

	LANCOM Location A	SIP terminal equipment location A	LANCOM Location B	SIP terminal equipment location B
Internal VoIP domain	location_A.internal	location_A.internal	location_B.internal	location_B.internal
Internal numbers		10 to 19		20 to 29
External SIP telephone number	4		4	
Access information for SIP account	4		4	
External ISDN telephone numbers (MSNs)	4		4	
Country and local area code	4		4	
SIP PBX line	LOCATION_B		LOCATION_A	
SIP PBX domains	location_B.internal		location_A.internal	
Call route	<ol style="list-style-type: none"> <li>1. Called number '2#'</li> <li>2. Destination line 'LOCATION_B'</li> <li>3. Destination number ''2#'</li> </ol>		<ol style="list-style-type: none"> <li>1. Called number '1#'</li> <li>2. Destination line 'LOCATION_A'</li> <li>3. Destination number ''1#'</li> </ol>	

 Although SIP PBX lines are the subject of the configuration presented here, you can still use this function even without a PBX.

Detailed instructions on configuring the LANCOM:



- Under LANconfig, start the setup wizard for configuring the VoIP Call Manager. Enable the options 'SIP phone system', 'ISDN phone system' and 'ISDN users'.

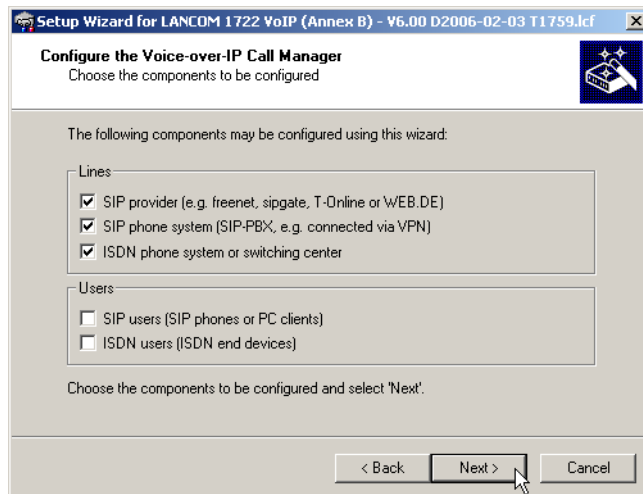

- Configure the device as described in the preceding examples:
  - one line to a SIP provider
  - ISDN line with MSN mapping
  - Area and country code for each location
- Enter a unique domain for the local VoIP domain which describes the local VoIP range for the site. Both sites use **different** VoIP domains, e.g. 'location\_A.internal' or 'location\_B.internal'.
- Configure the line leading to the SIP PBX with the following values:
  - SIP PBX line name: Unique name for the line leading to the remote site.
  - PBX SIP domain/realm: Internal VoIP domain for the remote site.
  - Registrar (FQDN or IP): Address for the LANCOM at the remote site, in the event that the device cannot be identified via DNS resolution of the VoIP domain (PBX SIP domain/realm).

---

  -  Use the private IP address that can be reached via VPN for the LANCOM here, not the public IP.
  - Leave the field for the shared password empty when registering to the SIP PBX.
  - Leave the field for the public PBX number empty.
- The call routing table suggested by the setup wizard automatically allows international and national long distance calls to be made via remote site's line, local calls are routed via ISDN.

## 15 Voice over IP (VoIP)

- In addition, a **standard route** directs all numbers which cannot be resolved to the remote location's line.

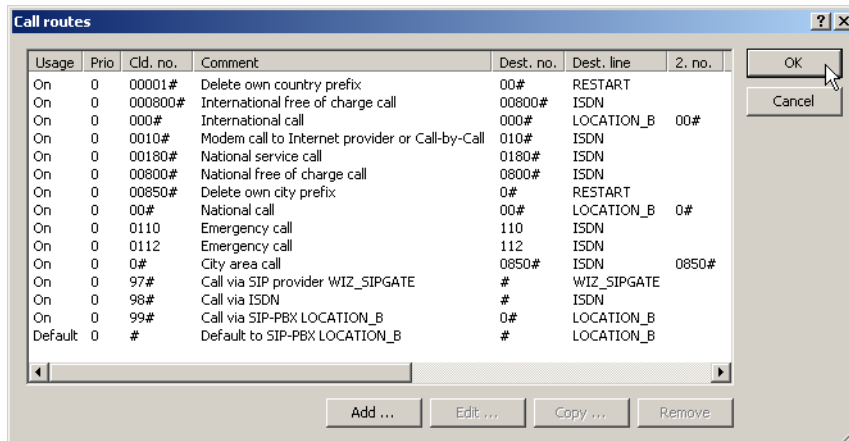

Usage	Prio	Cld. no.	Comment	Dest. no.	Dest. line	2. no.
On	0	00001#	Delete own country prefix	00#	RESTART	
On	0	000800#	International free of charge call	00800#	ISDN	
On	0	000#	International call	000#	LOCATION_B	00#
On	0	0010#	Modem call to Internet provider or Call-by-Call	010#	ISDN	
On	0	00180#	National service call	0180#	ISDN	
On	0	00800#	National free of charge call	0800#	ISDN	
On	0	00850#	Delete own city prefix	0#	RESTART	
On	0	00#	National call	00#	LOCATION_B	0#
On	0	0110	Emergency call	110	ISDN	
On	0	0112	Emergency call	112	ISDN	
On	0	0#	City area call	0850#	ISDN	0850#
On	0	97#	Call via SIP provider WIZ_SIPGATE	#	WIZ_SIPGATE	
On	0	98#	Call via ISDN	#	ISDN	
On	0	99#	Call via SIP-PBX LOCATION_B	0#	LOCATION_B	
Default	0	#	Default to SIP-PBX LOCATION_B	#	LOCATION_B	

- Adapt the suggested call routing table in order to make international and national long distance calls via the SIP provider line with backup over ISDN. When doing so, please observe that the '0' preceding the number must be removed.

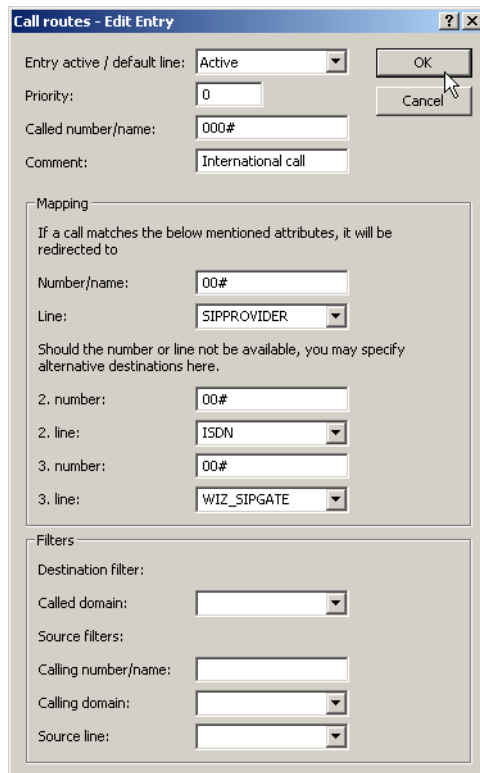

**Call routes - Edit Entry**

Entry active / default line:

Priority:

Called number/name:

Comment:

**Mapping**

If a call matches the below mentioned attributes, it will be redirected to

Number/name:

Line:

Should the number or line not be available, you may specify alternative destinations here.

2. number:

2. line:

3. number:

3. line:

**Filters**

Destination filter:

Called domain:

Source filters:

Calling number/name:

Calling domain:

Source line:

- After being adapted for international and national long distance, the call routing table should appear as follows:

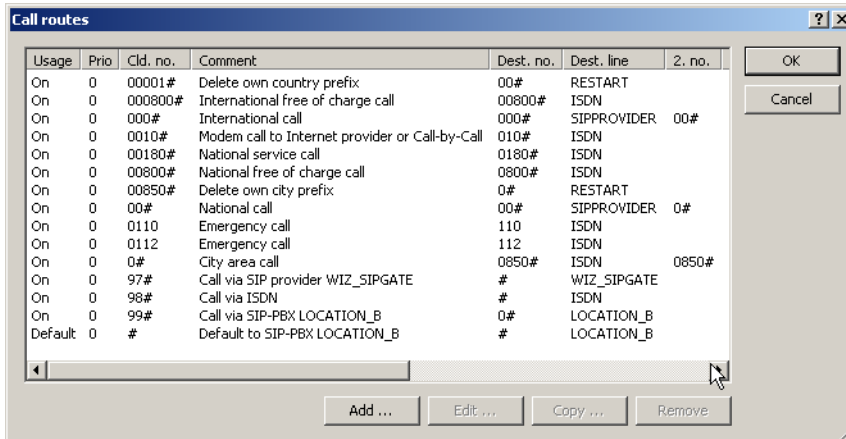

Usage	Prio	Cld. no.	Comment	Dest. no.	Dest. line	2. no.
On	0	00001#	Delete own country prefix	00#	RESTART	
On	0	000800#	International free of charge call	00800#	ISDN	
On	0	000#	International call	000#	SIPPROVIDER	00#
On	0	0010#	Modem call to Internet provider or Call-by-Call	010#	ISDN	
On	0	00180#	National service call	0180#	ISDN	
On	0	00800#	National free of charge call	0800#	ISDN	
On	0	00850#	Delete own city prefix	0#	RESTART	
On	0	00#	National call	00#	SIPPROVIDER	0#
On	0	0110	Emergency call	110	ISDN	
On	0	0112	Emergency call	112	ISDN	
On	0	0#	City area call	0850#	ISDN	0850#
On	0	97#	Call via SIP provider WIZ_SIPGATE	#	WIZ_SIPGATE	
On	0	98#	Call via ISDN	#	ISDN	
On	0	99#	Call via SIP-PBX LOCATION_B	0#	LOCATION_B	
Default	0	#	Default to SIP-PBX LOCATION_B	#	LOCATION_B	

- In this state, all calls that cannot be resolved by the call routing table and which do not have a corresponding entry in the local user list are automatically forwarded to the remote site.
  - If this is not desired, for example, where more than two sites are connected in this way, an additional entry can detect only the internal calls to a particular site. For this, make a new entry (for the number range '20' to '29' at location B) in the call routing table with the following values:
    - Called number / name: e.g. '2#' for all numbers that begin with a 2.
      - Number / name: The number called is remains unchanged and is used as a destination number, i.e. here, also '2#'.
      - Line: Enter the SIP PBX line for the remote location here, i.e. 'LOCATION\_B'.

In doing so, the standard route is adjusted so that all numbers which cannot be resolved are transmitted via ISDN.

After being adapted, the call routing table should appear as follows:

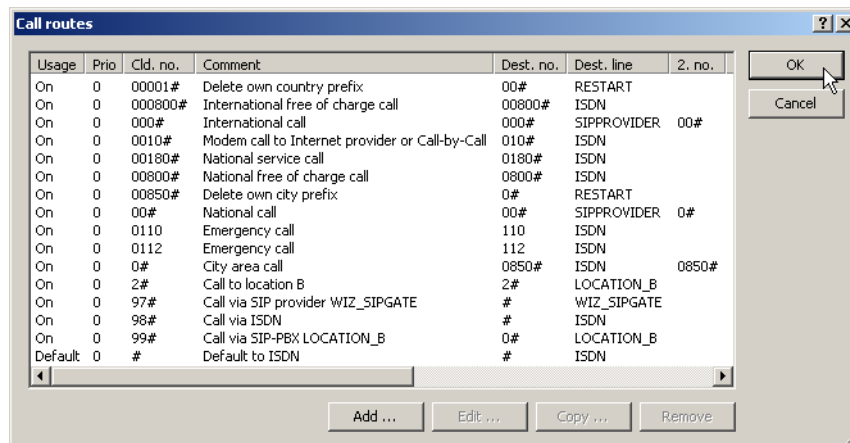

Usage	Prio	Cld. no.	Comment	Dest. no.	Dest. line	2. no.
On	0	00001#	Delete own country prefix	00#	RESTART	
On	0	000800#	International free of charge call	00800#	ISDN	
On	0	000#	International call	000#	SIPPROVIDER	00#
On	0	0010#	Modem call to Internet provider or Call-by-Call	010#	ISDN	
On	0	00180#	National service call	0180#	ISDN	
On	0	00800#	National free of charge call	0800#	ISDN	
On	0	00850#	Delete own city prefix	0#	RESTART	
On	0	00#	National call	00#	SIPPROVIDER	0#
On	0	0110	Emergency call	110	ISDN	
On	0	0112	Emergency call	112	ISDN	
On	0	0#	City area call	0850#	ISDN	0850#
On	0	2#	Call to location B	2#	LOCATION_B	
On	0	97#	Call via SIP provider WIZ_SIPGATE	#	WIZ_SIPGATE	
On	0	98#	Call via ISDN	#	ISDN	
On	0	99#	Call via SIP-PBX LOCATION_B	0#	LOCATION_B	
Default	0	#	Default to ISDN	#	ISDN	

- ! This entry for 'LOCATION\_B' is placed well down toward the end of the call routing table so as not to affect the more general rules. However, for interaction with the other routes, verify that only the internal numbers for the remote site are directed to the respective line.

## Configuring the VoIP terminal equipment

The VoIP terminal equipment is configured as described in the preceding examples with internal VoIP domains and internal numbers for the local site.

## Call routing procedure on outgoing calls

For this application, most calls take place as described in the preceding examples. Internal calls between locations are resolved as follows:

User	dials	correct call route	correct user	mapping, number in use	Destination line
VoIP telephone location A	21	2#	none	21	LOCATION_B

1. Internal call between two VoIP terminal devices at locations A and B. The number dialed '21' matches the route '2#' in the call routing table. The call router sends the call out over the line to the remote SIP PBX without changing the number.

### 15.13.7 The LANCOM VoIP Router at a P2P (point-to-point) connection

Many companies use a point-to-point ISDN connection instead of the more common point-to-multipoint connection. Point-to-point connections offer two significant advantages:

- Because extension numbers can be used (DDI – Direct Dialing In), all terminal devices can be directly reached via a common external switchboard number plus an extension number as a suffix.
- A larger number of B channels can be used with the same range of telephone numbers, whereas with a point-to-multipoint connection there are only two B channels, typically supporting up to 10 telephone numbers.

ISDN P2P connections are available either as a basic rate interface (BRI) with two B channels or as a primary rate interface (PRI) typically with 30 B channels. LANCOM VoIP Routers support the ISDN basic rate interface only. To be able to use more than four B channels, a P2P connection can be switched to multiple basic rate interfaces with the same range of telephone numbers.

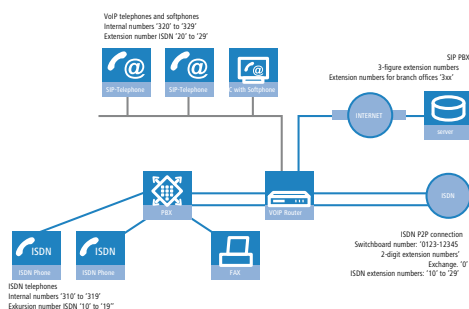

### Objectives in implementing the LANCOM VoIP Router

- Connecting additional SIP devices at the branch office.
- Internal calls to users based at the headquarters and other branch offices via the SIP PBX located at the headquarters (using VPN connection).

### Requirements

- LANCOM connected to LAN and WAN (via DSL/ADSL), ISDN-TE interface(s) are connected to the ISDN P2P connection, ISDN-NT interface(s) are connected to an ISDN PBX.
- The Internet connection has been set up by means of a VPN tunnel, as has the network connection between the two locations. All terminal devices can contact each other with the IP addresses used.
- A dialing plan with a unique internal telephone number for each piece of terminal equipment to be connected.

## Configuring the LANCOM

The configuration of the SIP client or connection to the SIP PBX as a SIP PBX line named 'HQ' has already been described in other example applications and, here, is assumed to be familiar to you. The SIP PBX at headquarters uses the SIP domain 'mycompany.HQ' and the branch office has the internal domain 'mycompany.BRANCH01'.

This is how the LANCOM is configured for operation at a point-to-point line:

1. The ISDN mapping table translates the DDI (extension numbers) to the internal numbers for processing as SIP calls.

MSN/DDI	ISDN/S0 Bus	Internal number	Comment
0	ISDN1, ISDN2	300	Maps DDI '0' to internal number '300'
#	ISDN1, ISDN2	3#	Adds the prefix '3' to all other DDI '0' for the internal numbers

1. Both entries in this example apply to the ISDN interfaces 1 and 2, which are connected to the ISDN line. The activation of two ISDN interfaces makes four B channels available for use. If both B channels of an ISDN interface are engaged, there is an automatic attempt to redirect calls to another ISDN interface with free B channels.
2. Based on the ISDN user entries, the internal numbers are translated back to the DDI numbers.

Internal number	MSN/DDI	ISDN/S0 Bus	Comment
300	0	ISDN3, ISDN4	Maps internal number '300' to DDI '0'. Useful if the exchange is on the ISDN PBX.
31#	1#	ISDN3, ISDN4	Removes the leading '3' from all internal numbers beginning with '3'.

1. With the second entry, all ISDN terminal devices with the ISDN extension numbers '10' to '19' are made known to be ISDN users in the VoIP system. A single entry here suffices for all subscribers. All ISDN users then use the same data to register at the SIP PBX.



ISDN users entered with the # symbol can only be reached from the SIP PBX if this does not require users to register. For ISDN users to register, separate entries in the ISDN user list are required.

Both entries in this example apply to the ISDN interfaces 3 and 4, which are connected to the ISDN PBX. Here, too, the four B channels of the two interfaces can be used "dynamically" for the connection between the ISDN PBX and the LANCOM VoIP Router.

2. Routing of calls is governed by the call routing table. If you use the LANconfig Wizard, the call-routing table is preset so that all outgoing calls from ISDN and SIP devices are conducted via the SIP PBX with the exception of local calls and calls to service numbers, such as 0800 numbers.

### 15.13.8 SIP trunking

In telecommunications jargon, trunking is the process by which several lines or connections are combined into one shared line. In the world of VoIP, SIP providers are increasingly offering products which provide the ability to make several calls simultaneously using a single account. Together with the possibility of being able to contact SIP participants via a shared switchboard number with individual extensions (DDIs), these types of accounts are also becoming attractive for business customers.

There are two possible options when using a SIP account with trunking:

- The customer retains his previous ISDN connection, along with any corresponding telephone numbers from the telephone company, and sets up an additional account having a separate number range with a SIP provider.

- The customer ports the numbers used thus far from the telephone company to the SIP provider and from then on uses the same numbers using SIP.

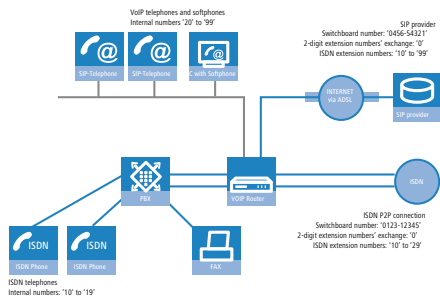

In this example we will take a look at a company planning to add a SIP trunking account, with up to 100 extension numbers, to its current ISDN point-to-point line having 20 extensions. The ISDN terminal devices with point-to-point line extensions used thus far can be retained. All new employees are to be issued with a SIP telephone with an extension via the SIP account.

Unique extensions are used since staff members have to be able to call each other internally. In order to migrate smoothly towards SIP, all ISDN terminal devices are to be contactable using **both** extension number and switchboard number of the SIP account. So an ISDN telephone should react in the same way for calls to '0123-12345 12' as it does for calls to '0456-54321 12'.

With the exception of emergency calls and service numbers, such as "0800" numbers, out-going calls are generally made using the SIP account. The signaling of SIP telephone numbers to call parties is paving the way for the medium-term discontinuation of ISDN telephone numbers.

## Objectives in implementing the LANCOM VoIP Router

- Connection of additional SIP terminal devices
- Internal calls between ISDN and SIP terminal devices.
- Continuation of availability using ISDN telephone numbers used thus far.
- Low-cost calls by using a shared SIP account.

## Requirements

- LANCOM connected to LAN and WAN (via DSL/ADSL), ISDN-TE interface(s) are connected to the ISDN P2P connection, ISDN-NT interface(s) are connected to an ISDN PBX.
- The Internet connection has been set up. All terminal devices can contact each other with the IP addresses used.
- A dialing plan with a unique internal telephone number for each piece of terminal equipment to be connected.

## Configuring the LANCOM

This is how the LANCOM is configured for operation at a point-to-point line:

1. The LANCOM is configured for operation at a point-to-point line by adding two simple entries in the ISDN mapping table and in the list of ISDN users.

ISDN mapping table

MSN/DDI	ISDN/SO Bus	Internal number	Comment
#	ISDN1, ISDN2	#	Outputs the unchanged DDI as an internal telephone number.

ISDN user list

Internal number	MSN/DDI	ISDN/S0 Bus	Comment
#	#	ISDN3, ISDN4	Outputs the unchanged internal number as a DDI.

- When configuring SIP clients, just the internal VoIP domain of the LANCOM VoIP Router and the associated internal number are entered. The extension numbers previously used for the ISDN terminal devices remain unallocated.
- A SIP provider line is created for the SIP account. The 'Trunk' option is selected as the mode for this line.
- Routing of calls is governed by the call routing table. When using the Wizards available with LANconfig, the call routing table is pre-configured such that all out-going calls from ISDN and SIP devices are made using the SIP trunk account (with the exception of local calls and calls to service numbers such as the emergency services or "0800" numbers).

### Process of call routing

In this example, call routing benefits from the unique internal telephone numbers.

- With in-coming calls, regardless of whether they are via ISDN or SIP, only the DDI is passed on to the LANCOM VoIP Router. Since the DDI and internal numbers are the same in this example, an extension number can be used to put through calls to locally registered SIP users or to dynamic ISDN users.

! If the reported DDIs can not, or should not, be used directly as internal numbers, corresponding telephone number translations are defined in the ISDN and SIP mapping tables, see and ..

- With out-going calls, the decision as to whether calls are made using ISDN or SIP may be controlled from the call routing table. In the default setting after using the Wizards, SIP is taken to be the normal destination line (with the exception of local calls and special numbers). Local calls, for example, may be switched to SIP by changing an entry in the call routing table.

! In this case, the SIP number is displayed at the subscribers on the other side of the connection, even if the call originates from an ISDN terminal device.

## 15.13.9 Remote gateway

Distributed company structures usually provide ISDN connections at branch offices to allow staff local access to the telephone network using appropriate ISDN terminal devices.

- A connection from the local ISDN terminal devices to a SIP PBX at the headquarters can easily be set up using a LANCOM VoIP Router.
- Furthermore, the "Remote Gateway" function can be used to connect both the terminal devices and the local ISDN connections to the central PBX. Benefits of the remote gateway:
  - The local ISDN connections are made available to all users in the company network. Calls to the local ISDN network can be made from anywhere as local calls (even from beyond state boundaries).
  - All calls, even those made by local users into their "own" telephone network, can be made via the SIP PBX, consequently facilitating central administration and logging.

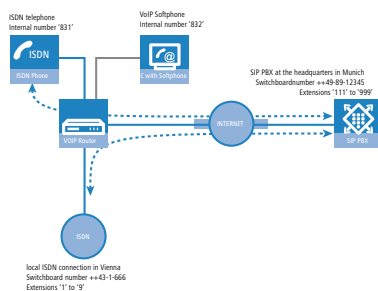

In this example we'll take a look at a company headquartered in Munich. The branch office in Vienna should be in a position to call the headquarters using the internal numbers. "83" numbers are taken from the headquarter's number range and are reserved for Vienna for this purpose. The sales and support departments at the company headquarters should also be contactable from Austria as a local, or national long-distance call from Vienna. The purchasing department would also like to be able to contact suppliers in Austria using national long-distance calls.

### Objectives in implementing the LANCOM VoIP Router

- Internal calls to users based at the headquarters and other branch offices via the SIP PBX located at the headquarters (using VPN connection).
- Integration of the local ISDN interface into the telephone structure of the organization.

### Requirements

- LANCOM Connected to LAN and WAN (via DSL/ADSL), ISDN-TE interface(s) are connected to the ISDN connection, ISDN-NT interface(s) are connected to an ISDN PBX or the ISDN terminal devices.
- The Internet connection has been set up by means of a VPN tunnel, as has the network connection between the two locations. All terminal devices can contact each other with the IP addresses used.
- A dialing plan with a unique internal telephone number for each piece of terminal equipment to be connected.

### Configuring the LANCOM

The following steps are involved when configuring the LANCOM VoIP Router:

- An entry is created for each ISDN user so that the terminal equipment can register with the upstream SIP PBX.
- For SIP clients, this registration information is entered in the VoIP telephone or the softphone.
- The connection to the SIP PBX, as a SIP-PBX line with the name 'HQ', has already been described in other application examples and familiarity with it is assumed from here on.
- In addition to this connection, a further connection "Gateway" needs to be made to the SIP PBX, which helps in making the local ISDN connection known to the upstream SIP PBX.
- The connection between the local ISDN connection and the remote SIP PBX is made using the entries in the call-routing table.

This is how the LANCOM is configured for operation as a remote gateway:

1. In the ISDN mapping table, local DDIs (extension numbers) are converted to internal telephone numbers for processing as SIP calls.

MSN/DDI	ISDN/S0 Bus	Internal number	Comment
#	ISDN1, ISDN2	#	All DDIs pending at the ISDN interfaces are switched further without being changed.

1. A new entry is created in the list of SIP provider connections with the following information:
  - Name of the connection: 'GW.HQ'
  - Mode: Gateway
  - SIP domain: SIP domain of the headquarters 'mycompany.HQ'
  - SIP ID: Account name for the SIP gateway in the SIP PBX located at the headquarters
  - Authentication name and password: Registration data for the SIP gateway
2. Additional entries are created in the call-routing table to switch calls between the headquarters and the local ISDN connection:



Called number	Destination number	Source line	Destination line	Comment
#	83#	ISDN	GW.HQ	Forwards all in-going calls arriving at the LANCOM VoIP Router over ISDN to the headquarters via the gateway. The DDI is preceded by '83' so as to map correctly to the internal numbers.
9	555	ISDN	GW.HQ	Forwards all in-going calls arriving at the LANCOM VoIP Router over ISDN to the headquarters via the gateway. '555' is used as the number for support.
0043#	0#	GW.HQ	ISDN	Forwards all out-going calls from the headquarters to the Austrian national network to the local ISDN connection (without country code).
#	#			Forwards all other calls without change.

### Call routing procedure on outgoing calls

User	dials	Call router receives	Call router sends	Assigned via	Source line	Destination line
ISDN network D	089-12345-831	831	831	1. List of local ISDN users	GW.HQ	Internal
ISDN network A	666-1	1	831	1. Call routing table 2. List of local ISDN users	ISDN	GW.HQ
ISDN network A	666-9	9	555	1. Call routing table	ISDN	GW.HQ
SIP exchange	0043-662-33333	0043-662-33333	0662-33333	1. Call routing table	GW.HQ	ISDN

- Call from customer in Hamburg to staff in Vienna. The customer dials the number of the Munich headquarters using the correct extension '089-12345-831'. Because the ISDN user is registered with the internal telephone number, the PBX at the headquarters receives only the DDI '831' and passed it on via the SIP PBX line. The LANCOM VoIP Router receives '831', locates a matching entry in the list of locally registered users and is able to connect the call.
- Call from customer in Vienna to the branch office in Vienna. The customer dials the number of the branch office in Vienna using the correct extension '666-1'.
  - The LANCOM VoIP Router receives the DDI '1' and is not able to locate a matching entry in the list of locally registered users. Using the call-routing table, the telephone number is changed to '831' and forwarded on to the PBX in Munich via the SIP gateway connection. The PBX recognizes the registered ISDN user with the internal telephone number '831' and passes the call back to the LANCOM VoIP Router via the SIP PBX line.
  - The LANCOM VoIP Router then receives '831', locates a matching entry in the list of locally registered users and is able to connect the call.
- Call from customer in Salzburg to the support number in Vienna. The customer dials the number of the branch office in Vienna using the correct extension '666-9'. The call is automatically put through to the internal support number '555' using the call routing table.
- Call from employee in Munich to customer in Salzburg. The employee dials '0043-662-33333'. The PBX in Munich is configured such that all calls to Austria are forwarded via the SIP gateway connection to the LANCOM VoIP Router. The call router receives the complete number, drops the country code as per the routing table having source line 'GW.HQ' and forwards the remaining number to the ISDN line.

 Here the call number from Munich is displayed at the remote site.

## 15.14 Diagnosis of VoIP connections

### 15.14.1 SIP traces

Trace output can be used to check the internal processes in LANCOM devices during or after configuration. A SIP trace displays all of the SIP information which is exchanged between a LANCOM VoIP Router and a SIP provider or upstream SIP PBX. The SIP trace is activated with the following command:

```
trace + sip-packet
```

### 15.14.2 Connection diagnosis with LANmonitor

LANmonitor displays a wealth of information about calls switched in the LANCOM:

- Information about the registered users.
- Information about the lines available.
- Information about current calls, including the translation of telephone numbers and domains by the Call Manager.

- Information about the fixed and automatic QoS bandwidth reservations and settings.

The image displays two screenshots of the LANmonitor software interface, showing configuration details for VoIP and QoS settings.

**Left Screenshot (VPN\_NHAMEL):**

- WAN connections:** 1
- VoIP Call Manager:**
  - Users:** 3
    - ISDN user: 10 (Registered local)
      - Type: ISDN user
      - Number/Name: 10
      - Domain: None
      - Interface: ISDN-1
      - Local registration: Registered
      - Remote registration: Registration pending
    - SIP user: 12@isdn (Norbert Hamel (ISDN) (Registered local))
    - SIP user: 12@bridgecom.intern (Norbert Hamel) (Registered local)
  - Lines:** 3
    - SIP provider: SIPGATE (Registered)
      - Type: SIP provider
      - Registration: Registered
      - Line: Ready
      - Domain: sipgate.de
    - SIP provider: FWD2 (Registered)
    - ISDN: ISDN
  - Calls:** 1
    - 12@bridgecom.intern (Norbert Hamel) -> SIPGATE: 0240549936311@sipgate.de
      - Source line: USER\_SIP
      - Source display name: Norbert Hamel
      - Source number/name: 12
      - Source domain: bridgecom.intern
      - Dialed number/name: 0240549936311
      - Dialed domain: bridgecom.intern
      - Destination line: SIPGATE
      - Destination number/name: 0240549936311
      - Destination domain: sipgate.de
      - Codec (source->destination): PCMA/8000 (G.711a-law)
      - Codec (destination->source): PCMA/8000 (G.711a-law)
      - Call time: 26.01.2006 14:47:15
      - Connect time: 26.01.2006 14:47:19
      - End time:
      - Status: Connected
  - Local domain: bridgecom.intern
  - Firewall: 1/26/2006 13:08:36 DENY\_ALL - Packet rejected
  - System information

**Right Screenshot (LC\_QS\_MUC2):**

- WAN-Verbindungen:** 1
  - ADSL Kanal 1: Nicht bereit
  - ISDN-1 Kanal 1: Bereit
  - ISDN-1 Kanal 2: Bereit
  - ISDN-2 Kanal 1: Bereit
  - ISDN-2 Kanal 2: Bereit
  - ISDN-3 Kanal 1: Bereit
  - ISDN-3 Kanal 2: Bereit
  - ISDN-4 Kanal 1: Bereit
  - ISDN-4 Kanal 2: Bereit
  - DSL Kanal 1: Verbunden mit INTERNET
    - DSL Port: DSL-1
    - Protokoll: PPP
    - VPN-Verbindungen: 1
    - Verbindungszeit: 30 Minuten und 19 Sekunden
    - Sende 975 Byte/s, empfangen 1026 Byte/s
    - QoS**
      - Upstream-Rate: 192 kBit/s
      - Downstream-Rate: 1532 kBit/s
      - Rx reserviert: 0 kBit/s
      - Tx reserviert: 0 kBit/s
      - Fragmentgröße: 0 Byte
      - PMTU-Größe: 0 Byte

- VPN-Verbindungen: 1; CRL-Status: CRL-Funktionalität abgeschaltet
- VoIP Call Manager
- Firewall: 5/12/2006 8:19:42 intruder detection - Paket verworfen
- System-Informationen
- Standortverifikation: Erfolgreich

## 15.15 Addition(s) to LCOS 7.80

### 15.15.1 Global settings, DiffServ for SIP & RTP

The Voice Call Manager marks SIP and RTP packets with DiffServ CodePoints (DSCP), which enables other hardware to recognize and prioritize these packets.

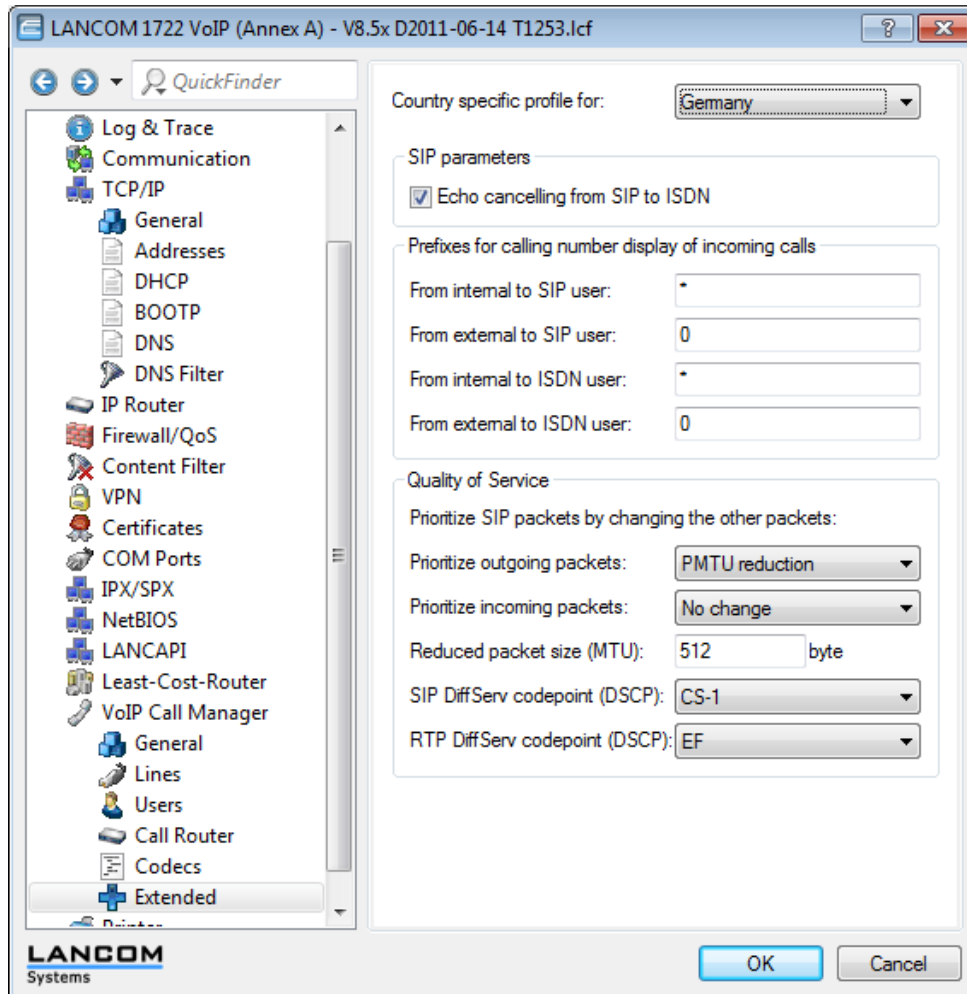

LANconfig: Voice Call Manager / Advanced

WEBconfig: LCOS menu tree / Setup / Voice Call Manager / General

- SIP DiffServ CodePoint (DSCP)

This defines which DiffServ CodePoints (DSCP) the SIP packets (for call signaling) are to be marked with.

Possible values:

- BE, CS-0, CS-1, CS-2, CS-3, CS-4, CS-5, CS-6, CS-7, AF-11, AF-12, AF-13, AF-21, AF-22, AF-23, AF-31, AF-32, AF-33, AF-41, AF-42, AF-43, EF

Default:

- CS-1

---

 The option CS-1 is actually outdated now, but it is set as the default value to ensure backwards compatibility. Common values for modern VoIP installations are CS-3, AF-31 or AF-41. We recommend using CS-3, one of the most widespread settings on the market.

- **RTP DiffServ CodePoint (DSCP)**

This defines which DiffServ CodePoints (DSCP) the RTP packets (voice data stream) are to be marked with.

Possible values:

- BE, CS-0, CS-1, CS-2, CS-3, CS-4, CS-5, CS-6, CS-7, AF-11, AF-12, AF-13, AF-21, AF-22, AF-23, AF-31, AF-32, AF-33, AF-41, AF-42, AF-43, EF

Default:

- EF

---

 With DSCP set to BE or CS-0 the packets are sent unmarked. Further information about DiffServ CodePoints is available in the Reference Manual under the section "QoS".

## 15.16 Addition(s) to LCOS 8.60

### 15.16.1 SIP ALG: Proxy for bypassing NAT in the router

The following sections provide explanations on the SIP ALG.

#### SIP ALG: Basics

SIP is increasingly becoming established as the basis for modern real-time communication in IP networks. Unified Communications (UC) and collaboration, IP telephony, video streaming, camera surveillance, intercoms, paging systems, and audio recordings increasingly rely upon SIP and RTP for switching and transmission.

The NAT (Network Address Translation) typically carried out by the access router at the edge of the LAN presents a barrier to SIP communications. This is because of the addresses transmitted during SIP signaling and also because of the dynamically negotiated media sessions and the UDP-based RTP connections that depend upon them.

Restrictive firewall configurations prevent communications even where client/server-side mechanisms such as STUN, ICE and TURN are used to overcome NAT.

The SIP ALG (Application Layer Gateway) for LCOS detects SIP connections and the RTP-based media streams that they depend upon and transforms these in line with the NAT rules in the access router.

Also, the SIP ALG monitors the bandwidths of the SIP connections and so provides QoS.

#### SIP ALG: Features

The SIP-ALG for LCOS has the following features:

- **No local registration:** The SIP proxy does not provide registration for SIP endpoints. Instead, it mediates the registrations directly to the approved SIP domains.

---

 This means that it is impossible to set up a line backup over alternative voice lines (analog, ISDN).

- **Transparency for SIP extensions:** The SIP ALG also transmits unknown, non-standard header elements to enable the SIP messages to be communicated between terminal devices and SIP PBXs.

---

 The SIP ALG determines an unambiguous destination for every SIP message. Forking (communication between multiple devices of the same identity) is handled upstream. The SIP-ALG merely provides transparent forwarding of these data packets.

## SIP ALG: Configuration

The following sections provide explanations for the configuration of the SIP ALG.

 The SIP ALG is disabled in the default settings.

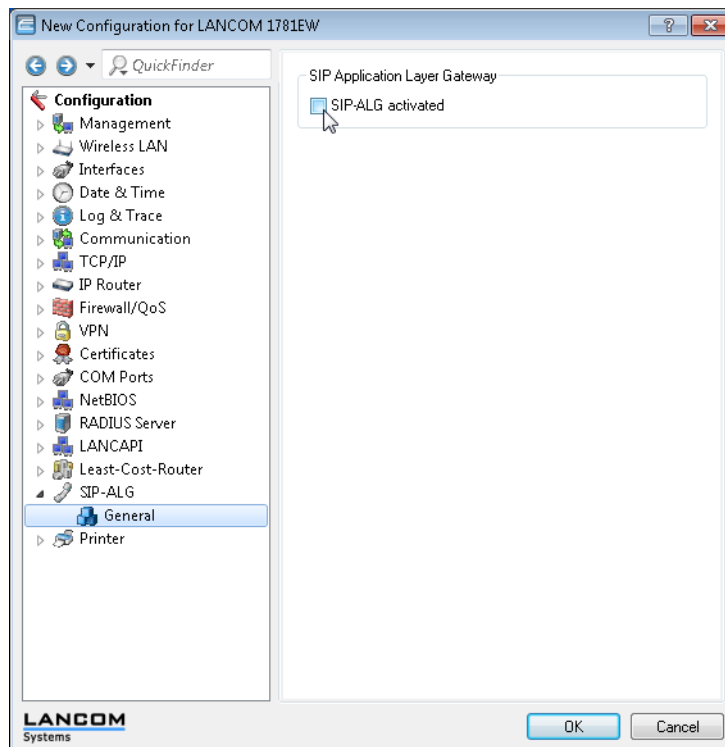

### SIP ALG: Configuration by LANconfig

1. Start LANconfig, for example from the Windows start menu with **Start > Programs > LANCOM > LANconfig**. LANconfig now automatically searches the local network for devices. As soon as LANconfig has completed its search, it presents a list of all the devices it found, if possible with a brief description, the IP address and the status.
2. Double-click on the entry for the device on which the SIP ALG is to be configured. LANconfig opens the Configuration Wizard and displays the current configuration of the device.
3. In the Configuration Wizard, switch to the menu **SIP-ALG > General**.
4. If necessary, highlight the option **SIP ALG activated**. This option is already enabled in the default setting.
5. Close the configuration by clicking on **OK**.

### Additions to the Setup menu

#### SIP ALG

Configure the settings for the SIP ALG here.

#### SNMP ID:

2.200

#### Telnet path:

Setup

**Operating**

This setting determines whether the SIP ALG is enabled.

**SNMP ID:**

2.200.1

**Telnet path:**

**Setup > SIP-ALG**

**Possible values:**

Yes

No

**Default:**

No

**Additions to the Status menu****SIP ALG**

This directory contains the status information provided for the SIP ALG (application layer gateway)

**SNMP ID:**

1.201

**Telnet path:**

**Status**

**Calls**

This table shows all current calls being routed via the SIP ALG.

**SNMP ID:**

1.201.3

**Telnet path:**

**Status > SIP-ALG**

**Call ID**

The call ID of the call.

**SNMP ID:**

1.201.3.2

**Telnet path:**

**Status > SIP-ALG > Calls**

**SIP destination address**

The IP address of the call destination.

**SNMP ID:**

1.201.3.3

**Telnet path:**

**Status > SIP-ALG > Calls**

**SIP source address**

The IP address of the call source.

**SNMP ID:**

1.201.3.4

**Telnet path:**

**Status > SIP-ALG > Calls**

**SIP source port**

The port used by the call source.

**SNMP ID:**

1.201.3.5

**Telnet path:**

**Status > SIP-ALG > Calls**

**WAN address**

The WAN address from which the call is made.

**SNMP ID:**

1.201.3.6

**Telnet path:**

**Status > SIP-ALG > Calls**

**SIP WAN port**

The WAN port from which the call is made.

**SNMP ID:**

1.201.3.7

**Telnet path:**

**Status > SIP-ALG > Calls**

**RTP destination address**

The destination address used by RTP.

**SNMP ID:**

1.201.3.8

**Telnet path:**

**Status > SIP-ALG > Calls**

**RTP source port**

The destination port used by RTP.

**SNMP ID:**

1.201.3.9

**Telnet path:**

**Status > SIP-ALG > Calls**



### RTP source address

The source address used by RTP.

**SNMP ID:**

1.201.3.10

**Telnet path:**

**Status > SIP-ALG > Calls**

### RTP source port

The source port used by RTP.

**SNMP ID:**

1.201.3.11

**Telnet path:**

**Status > SIP-ALG > Calls**

### RTP WAN port

The WAN port used to communicate by RTP.

**SNMP ID:**

1.201.3.12

**Telnet path:**

**Status > SIP-ALG > Calls**

### Registrations

This table shows all current registrations.

**SNMP ID:**

1.201.2

**Telnet path:**

**Status > SIP-ALG**

### SIP-ID

The SIP ID of the subscriber is the phone number of the SIP account or the user's name (SIP URI).

**SNMP ID:**

1.201.2.2

**Telnet path:**

**Status > SIP-ALG > Registrations**

### Registrar domain

This shows the domain where the SIP ID is registered.

**SNMP ID:**

1.201.2.3

**Telnet path:**

**Status > SIP-ALG > Registrations**

### Registrar address

The IP address which the registrar can be reached.

**SNMP ID:**

1.201.2.4

**Telnet path:**

**Status > SIP-ALG > Registrations**

### Client address

The IP address of the SIP client.

**SNMP ID:**

1.201.2.5

**Telnet path:**

**Status > SIP-ALG > Registrations**

### Client port

The port used by the SIP client.

**SNMP ID:**

1.201.2.6

**Telnet path:**

**Status > SIP-ALG > Registrations**

### WAN address

The WAN address used by this SIP ID.

**SNMP ID:**

1.201.2.7

**Telnet path:**

**Status > SIP-ALG > Registrations**

### WAN port

The WAN port used by this SIP ID.

**SNMP ID:**

1.201.2.8

**Telnet path:**

**Status > SIP-ALG > Registrations**

### Register method

This is the method used to establish a new connection.

**SNMP ID:**

1.201.2.9

**Telnet path:**

**Status > SIP-ALG > Registrations**

**Possible values:**

REGISTER  
INVITE  
OPTIONS  
NOTIFY  
PUBLISH  
SUBSCRIBE  
INFO

**Expiration time**

The time in seconds before re-registration is required. This value does not indicate the time remaining but the time period negotiated during registration.

**SNMP ID:**

1.201.2.10

**Telnet path:**

**Status > SIP-ALG > Registrations**

**Operating**

This value indicates whether the SIP ALG is enabled or not.

**SNMP ID:**

1.201.1

**Possible values:**

Yes  
No

## 15.16.2 Restricting or preventing SIP registration over WAN connections

As of LCOS version 8.60 RC2, you can restrict the registration of SIP users at the Voice Call Manager over a WAN link, or prevent this altogether. The configuration for the SIP user now includes a new parameter that controls this. You can allow unrestricted registration over the WAN, via VPN only, or you can prohibit this altogether.

Additional security for the registration is provided by a count of the number of times that a SIP user authenticates incorrectly. Once the counter reaches a threshold value, the device locks the SIP user's account for a certain time. During

this period the SIP user cannot log on to the Voice Call Manager. You can freely set the values for the threshold and the duration of the lock.

## Additions to the Setup menu

### Access from WAN

This item determines whether and how SIP clients can register via a WAN connection.

#### SNMP ID:

2.33.3.1.1.8

#### Telnet path:

Setup > Voice-Call-Manager > Users > SIP-User > Users

#### Possible values:

Yes

No

VPN

#### Default:

No

### Lock minutes

Determines for how many minutes a SIP user will be blocked after authentication has failed due to incorrect login data.

#### SNMP ID:

233.2.17

#### Telnet path:

Setup > Voice-Call-Manager > General > Lock-Minutes

#### Possible values:

0 to 255 minutes

#### Special values:

0: Lock off

**Default:**

5

**Login errors**

This value specifies the number of failed attempts before a SIP user is locked for a certain time.

**SNMP ID:**

233.2.18

**Telnet path:****Setup > Voice-Call-Manager > General > Login-Errors****Possible values:**

0 to 255

**Special values:**

0: The first false login triggers the lock.

**Default:**

5

**Additions to the Status menu****Local register**

This column indicates whether the individual SIP users are registered locally, not registered, incorrectly authenticated or blocked.

**SNMP ID:**

153.3.6

**Telnet path:****Status > Voice-Call-Manager > Users > Local-register****Possible values:**

Registered

Not-registered

Auth-failure

Blocked

**Default:**

Blank

## 15.17 Addition(s) to LCOS 8.62

### 15.17.1 Default setting for WAN registration of a SIP user

The default setting for the WAN registration of a SIP user has changed from 'yes' to 'no'.

## Additions to the menu system

### Access from WAN

This item determines whether and how SIP clients can register via a WAN connection.

**SNMP ID:**

2.33.3.1.1.8

**Telnet path:**

**Setup > Voice-Call-Manager > Users > SIP-User > Users**

**Possible values:**

Yes

No

VPN

**Default:**

No

## 15.18 Addition(s) to LCOS 8.80

### 15.18.1 Default setting for WAN registration of a SIP user

The default setting for the WAN registration of a SIP user has changed from 'yes' to 'no'.

## Additions to the menu system

### Access from WAN

This item determines whether and how SIP clients can register via a WAN connection.

**SNMP ID:**

2.33.3.1.1.8

**Telnet path:**

**Setup > Voice-Call-Manager > Users > SIP-User > Users**

**Possible values:**

Yes

No

VPN

**Default:**

No

## 16 High availability – backup solutions

### 16.1 High availability for networks

Networked cooperation between several offices or even between continents has become an everyday part of modern business. The paths of communication between headquarters, subsidiaries and field workers increasingly rely upon public infrastructures. VPN has become established as the de facto standard for cost-effective and secure enterprise communications over the Internet.

However, many of important elements in these network structures remain susceptible to failure which could have severe consequences for business operations:

- The remote Internet gateway itself can fail.
- The physical lines for the connection to the Internet or to a remote network can fail:
  - The Internet-access cable between the site and the provider could fail; after damage from construction work, for example.
  - The DSL connection may fail, while the ISDN connection remains functional.
- The provider's network may be disturbed or even fail.

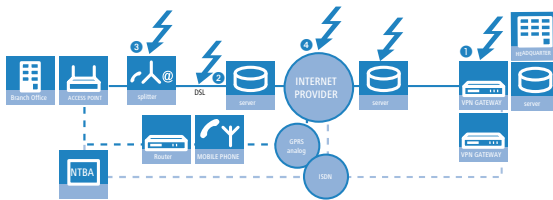

Internet routers and access points from LANCOM offer a range of security and backup functions that can be used for the protection of your network from disturbance.

#### 16.1.1 How is a network-connection disturbance detected?

The first stage in protecting a network connection from the effects of a disturbance is to detect the disturbance itself. The following methods are available to check the connections:

- Check the PPP connection to the provider with PPP LCP echo monitoring.
- Check if remote stations can be contacted via name or IP address with ICMP polling (ping from end to end).
- Check the tunnel end points with "dead peer detection" (DPD).

##### PPP LCP echo monitoring

The method checks the PPP connection to a certain remote site with regular LCP requests. This method is typically used to check the connection to the Internet provider. LCP requests are directly sent to the access server.

In the PPP list, a time interval for the transmission of LCP requests to the remote site is defined for this connection. Further, for the event that LCP replies are missed, the number of retries before the transmission of a new LCP request is defined. Should the transmitter not receive any reply to the retries, the line is considered to have failed.

- **Time:** The time entered into the PPP list must be multiplied by the factor 10 to arrive at the actual interval between two LCP requests. Entering the time as "5" means that an LCP request will be prompted every 50 seconds.
- **Retries:** If no reply to an LCP request is received then the remote site will be checked in shorter intervals. The device then tries to reach the remote site once a second. The number of retries defines how many times these attempts are

repeated. Entering "5" under retries means that the LCP request will be repeated 5 times before the connection is considered to have failed.

! PPP LCP monitoring only checks the PPP connection path as far as the Internet provider.

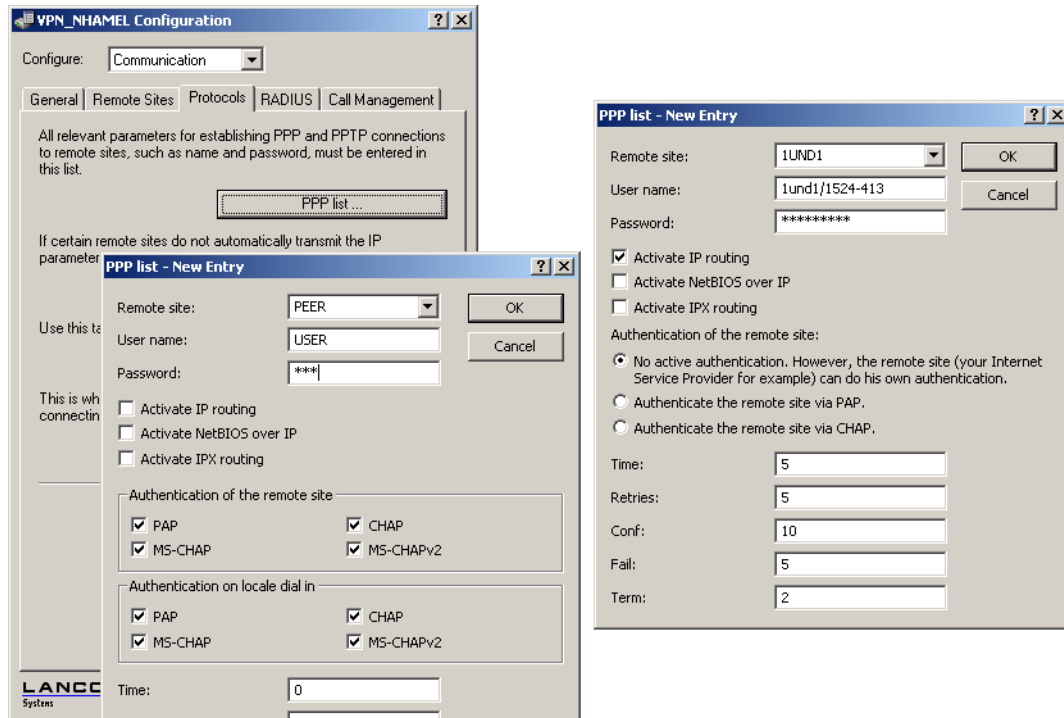

LANconfig: Communication / Protocols / PPP list

WEBconfig: LCOS menu tree / Setup / WAN E PPP list

## ICMP polling

Similar to LCP monitoring, ICMP polling transmits regular requests to a remote site. Ping commands are transmitted and the answers to them are monitored. Unlike LCP monitoring, the target site for ICMP pings can be freely defined. Pinging a router in a remote network thus provides monitoring for the entire connection and not just the section to the Internet provider.

A ping interval is defined for the remote site in the polling table. Further, for the event that replies are missed, the number of retries before the transmission of a new LCP request is defined. Should the transmitter not receive any reply to the retries, the target for the ping requests is classified as unavailable.

Up to four different IP addresses can be entered for each remote site that will be checked in the remote network in parallel. Only if all of the IP addresses are unavailable is the connection considered to have failed.

! With the ICMP polling, an entire connection can be monitored from end to end.

- **Name of the remote site**
- **IP address 1-4:** IP addresses for targeting with ICMP requests to check the remote site.

! If no IP address is entered for a remote site that can be checked with a ping, then the IP address of the DNS server that was determined during the PPP negotiation will be checked instead.

- **Ping interval:** The time entered into the polling table defines the time interval between ping requests. If the value "0" is entered, then the standard value of 30 seconds applies.



- Retries:** If no reply to a ping is received then the remote site will be checked in shorter intervals. The device then tried to reach the remote site once a second. The number of retries defines how many times these attempts are repeated. If the value "0" is entered, then the standard value of 5 retries applies.

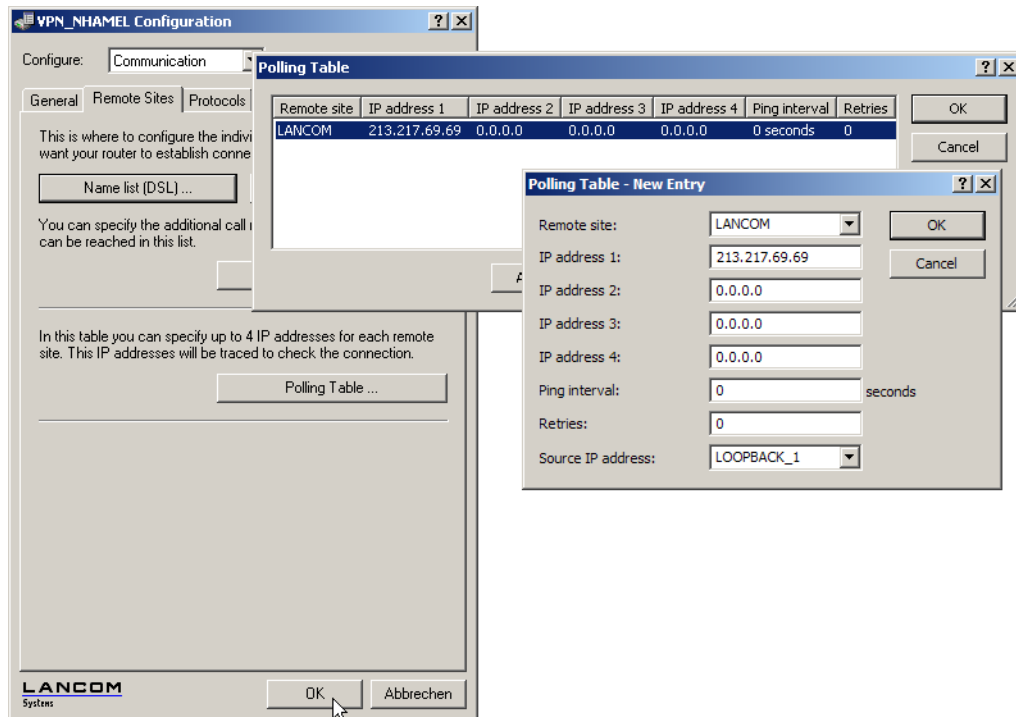

LANconfig: Communication / Remote sites E Polling table

WEBconfig: LCOS menu tree / Setup / WAN E Polling table

## Dead peer detection (DPD)

This method of connection monitoring is used when VPN clients dial-in to a VPN gateway. This is designed to ensure that a client is logged out if there is an interruption to the VPN connection, for example when the Internet connection is interrupted briefly. If the line were not to be monitored, then the VPN gateway would continue to list the client as logged-on. This would prevent the client from logging in again as, for example, the WLANmonitor prevents single serial numbers from multiple simultaneous log-ins.

! For the same reason, without line monitoring a user with the same "identity" (user name) would be prevented from dialling in because the associated user would still be in the list for the logged-in client.

With dead peer detection, the gateway and client regularly exchange "keep alive" packets. If no replies are received, the gateway will log out the client so that this identity can be registered anew once the VPN connection has been re-established. The DPD time for VPN clients is typically set to 60 seconds.

The dead peer detection is set up with LANconfig in the configuration area 'VPN' on the 'General' tab in the 'Connection list'.

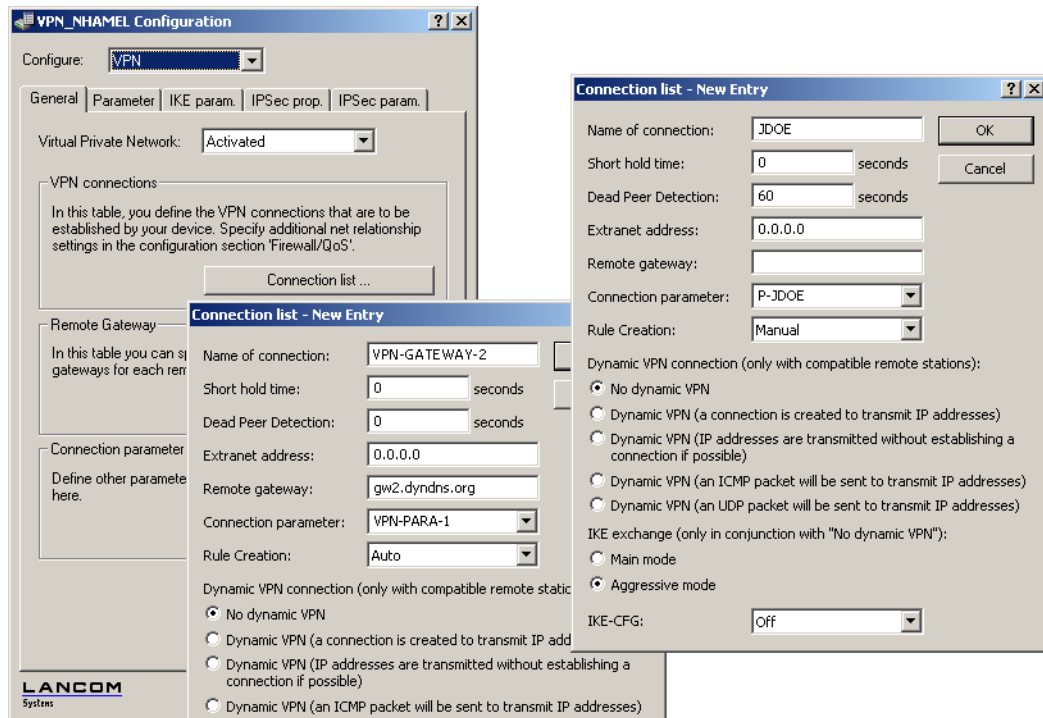

LANconfig: VPN / General / Connection list

WEBconfig: LCOS menu tree / Setup / VPN E VPN-Peers

## 16.1.2 High-availability of lines – backup connections

If there is a disturbance to the connection with the Internet provider or to a remote network, a backup line can act as a temporary replacement for the normal data line. This requires the existence of a second physical connection which can be used to contact the remote site. Examples of backup lines are typically:

- An ISDN line as a backup for DSL Internet access
- An ISDN line as a backup for VPN network coupling
- A modem connection (GSM or analog) as a backup for DSL or ISDN lines and VPN connections

### Configuration of the backup connection

The following steps are necessary to define a backup connection:

1. The backup connection requires the appropriate WAN interface to be set up so that the remote site can be reached via this alternative route. If, for example, the ISDN line is to serve as the backup connection, then the remote site is set up as an ISDN remote site (along with the necessary entries in the communications layers and in the PPP list).
2. If the connection to the remote site cannot be checked with LCP requests, the monitoring of the connection should be initiated with an entry in the polling table.
3. Assignment of the new backup connection to the remote site which is to be backed up. This entry is made in the backup table. Dedicated entries in the routing table are not required for a backup connection. The backup connection automatically takes over the source and target networks from the remote site that routes the data under normal operating conditions.

A remote site can be assigned with multiple backup lines in the backup table. In the case of backup, the system decides which backup line is to be used first:

- The last remote site that was reached successfully

- The first remote site in the list

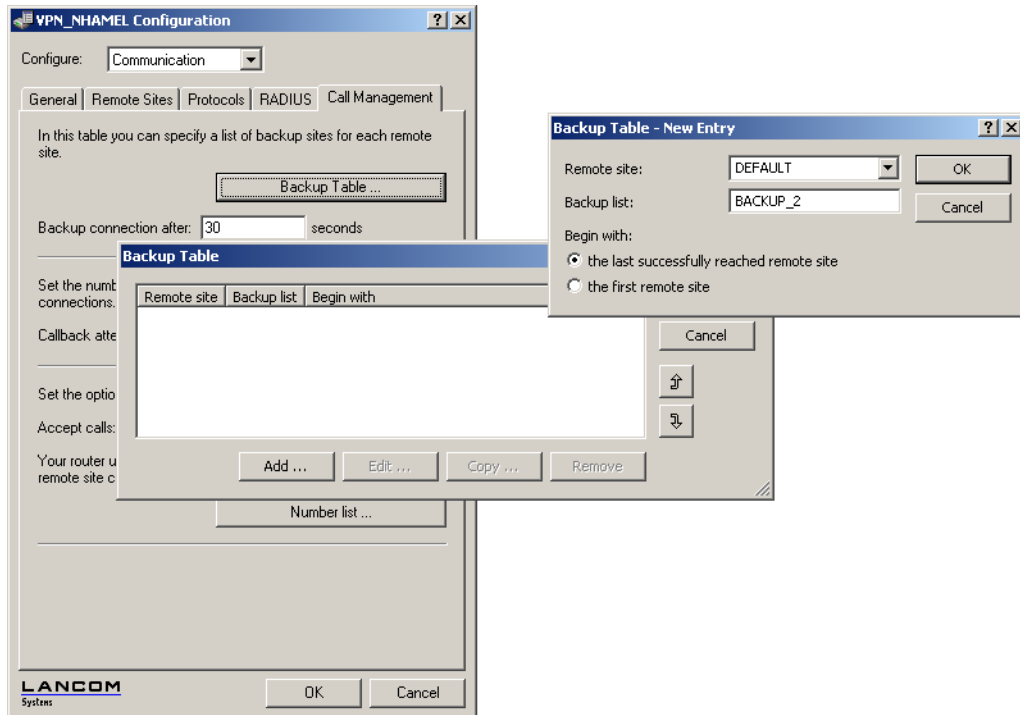

LANconfig: Communication / Call management / Backup table

WEBconfig: LCOS menu tree / Setup / WAN E Backup table

## Triggering the backup connection

The backup is triggered when the monitoring mechanisms defined for the standard connection (LCP or ICMP polling) detect that contact to the remote site has been lost.

The backup connection will be established if:

- The backup delay time has expired and
- either
  - a data packet is to be transferred or
  - a hold time of 9999 seconds has been defined for the backup connection.

The backup delay time is set with LANconfig in the configuration area 'Communication' on the 'Call management' tab or alternatively with Telnet under `/Setup/WAN-Modul/Backup-delay-seconds`.

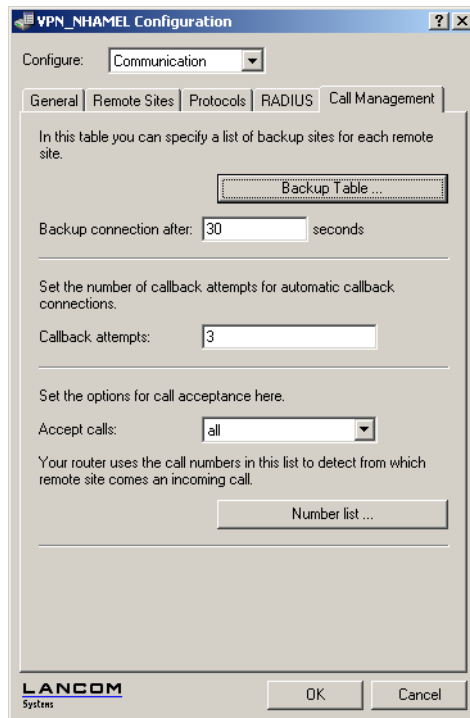

### Return to the standard connection

The router constantly tries to establish the standard connection while the backup connection is active. As soon as the standard connection has been established, the backup connection is terminated and the line monitoring with LCP or ICMP polling is resumed.

### Only keep-alive connections return automatically!

The standard connection will only be automatically re-established after a backup event if the hold time for the connection is configured properly:

- A hold time of "0" means that the connection will not be actively terminated. If the connection is interrupted, it will not be automatically established again. Only when communication is required of the connection will it be established.
- A hold time of "9999" means that the connection is permanently kept open. If it is interrupted, then the connection will be actively opened up again. This behavior is known as **keep alive**.

Set the hold time to "9999" for connections to the Internet provider (in the corresponding peer list) and backed-up VPN connections (in the VPN connection list) to ensure that the connection is automatically re-established and resumes data transfer after interruption.

### 16.1.3 High-availability of gateways – redundant gateways with VPN load balancing

Another cause of failure apart from the connection to the provider or to another network may lie with the local gateway. Severe effects can result from the failure of a central VPN gateway that is used, for example, to connect the networks of multiple remote locations with the central network at headquarters.

To ensure that the headquarters remains in contact, multiple VPN endpoints (generally identically configured VPN gateways operated in parallel) can be installed. Should line polling (with dead-peer detection, ICMP line polling) indicate a failure, then a variety of strategies (e.g. the random selection of one of the available gateways) can be used to enable communication to a different VPN end point. At the central headquarters, the new router and the local default gateway are propagated by dynamic routing (RIP V2).

To avoid the situation where the additional VPN gateways remain unused, intelligent load balancing ensures that all of the devices share the load of incoming and outgoing connections also under normal operating conditions.

More information about redundant gateways and load balancing is available under .

### 16.1.4 High-availability of the Internet access – Multi-PPPoE

The third of the different basic sources of failures is the case where the gateways and connections are in order but the provider's own network is down. Such cases are handled by setting up multiple PPOE connections at the physical interface of a single device (Multi-PPPoE).

To define these backup solutions as alternative Internet accesses you can use, for example, the Setup Wizard to set up two Internet access accounts one after another. The standard Internet access for normal operations should be set up last. Consequently, the entries in the routing table will be associated with the appropriate remote site.

Additionally, an entry is made in the backup table that defines the alternative Internet access account as the backup to the remote site at the standard provider.

More information about the definition of multiple PPPoE connections is available under .

### 16.1.5 Example applications

#### Backup DSL Internet access with ISDN internet access

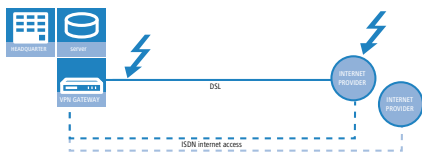

In this simple backup scenario, Internet access is realized via a DSL connection. An ISDN connection is defined as a backup in case of failure of the DSL Internet access.

This backup solution can be quickly and easily set up with the help of the LANconfig Setup Wizard, for example. A further degree of security is available by defining another Internet provider in addition to the standard provider. This solution caters for the contingency where the provider's network fails and the problem is not caused by the DSL connection.

#### Backup dynamic VPN network coupling with an ISDN direct dial up connection

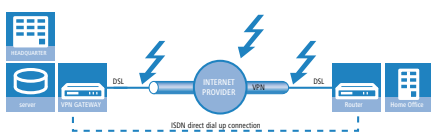

In the case that a branch office is connected to the headquarters via a VPN connection, the Internet-based VPN connection can be backed up by a direct ISDN dial-in connection. Should the Internet connection fail at either of the two routers, the data transmission is transferred to the ISDN link.

In this scenario we are assuming a fully configured VPN connection between the two networks.

- A LAN-LAN coupling via ISDN is additionally set up between the two networks. Do **not** use the Setup Wizard to set up this network coupling! The Wizard would change the entries in the routing table and would thus upset the function of the VPN network connection. Set up the ISDN network coupling in both routers manually— with the appropriate entries for the remote sites in the peer list, the PPP list and with the necessary telephone numbers and access identifiers.
- In the gateway at the headquarters, create an entry in the backup table that acts to backup the VPN remote site via a directly dialled ISDN remote site.

- Further, the router at the headquarters requires an entry for the monitoring of a remote device in the network at the branch office: Typically in the form of the LAN IP address at the remote VPN gateway. This entry ensures that the router at the headquarters can react immediately to a failure of the VPN connection.

Should there be a failure in the connection between the headquarters and branch office (on the way to the Internet provider or at the provider itself) then the ISDN connection takes over the data transfer independent of the Internet.

## Redundant VPN gateways

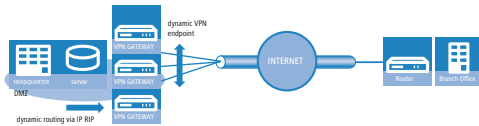

In decentralized company structures that rely on VPN for networking the various locations, the availability of the central VPN gateway is of particular significance. The company-wide communications only remain reliable as long as these central dial-in nodes are working properly.

With the option of configuring several "remote gateway" addresses as "dynamic VPN endpoints" for a VPN connection, LANCOM VPN gateways offer a high level of availability by using redundant devices. This involves multiple gateways at the headquarters being set up with identical VPN configurations. On location at the satellite sites, all of these available gateways are entered as possible remote stations for the VPN connection. If one of the gateways is unavailable, the remote router automatically redirects the request to one of the other routers.

To ensure that the computers in the LAN at the headquarters know which VPN gateway it to be used to reach a particular satellite station, the outband router currently connected to the remote site is propagated via RIPv2 to the network at the headquarters.

 A powerful mechanism for load balancing between the VPN gateways at the headquarters is attained with the configuration of the satellite stations to select the remote site for VPN connection on a random basis ("VPN load balancing").

Further information to redundant gateways and "VPN Load Balancing" can be found in .

## Backup a VPN gateway with an ISDN gateway and RIP

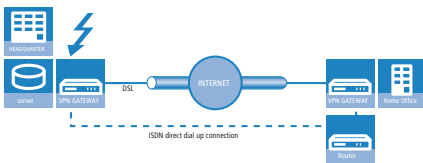

Going a step further, the VPN gateways themselves can be backed up in case of failure. This case assumes the existence of a VPN connection between two gateways. In the event that one of the two VPN devices should fail, an ISDN connection is to take over the data transfer; in this case via a direct dial-in connection.

Regarding the configuration of this solution, we again assume a functional VPN coupling of the two networks. The following additional steps are required:

- A standard ISDN network coupling that routes the same subnets as the VPN connection is set up between the two ISDN routers. In the routing table, however, a distance is entered that is at least 1 higher than the corresponding route in the VPN gateway.
- The local RIP (RIP V2) has to be activated in all routers so that the VPN and ISDN routers can exchange information about the routes with the remote sites. The higher distance of the route via the ISDN gateway is, under normal circumstances, the poorer route.
- It is not necessary to define a backup connection in this case as a different device should take over the data transmission.

If there is a disturbance in the connection between the VPN devices, the value for the distance of the corresponding routes changes automatically: A route which is not available is marked with a distance of 16. Consequently, the route entered into the ISDN router automatically becomes the "better" solution and all data packets will be re-routed over the ISDN connection. As soon as the VPN connection is re-established, the distance changes to a value below that of the ISDN connection and the backup will be terminated as intended.

## 16.2 Backup Solutions and Load Balancing with VRRP

### 16.2.1 Introduction

For businesses in particular, the high availability of data connections presents an essential requirement of the network components. LANCOM Systems devices provide various mechanisms for securing data transfer as a backup solution:

- Various WAN interfaces (DSL, ISDN, UMTS) enable data transfer over a second physical medium if the primary WAN interface is disturbed or fails.
- In order to provide protection from failure of an Internet provider's network, different Internet access accounts can be configured with Multi-PPoE.
- Two or more VPN gateways in a network can share the VPN tunnels required, thus keeping data traffic alive even in cases of temporary failure of a VPN end point.
- VRRP can now also be used to implement a sophisticated backup system for protection against router hardware failure. Two or more routers are installed in a network, one of which can replace the other in case of device failure.
- In addition to normal VRRP, LANCOM devices can link the backup event triggering function to the availability of a data connection. With this additional feature, LANCOM devices with more than one WAN interface (e.g. DSL and ISDN interface) can be implemented flexibly in backup solutions. The backup event is triggered for example, when the default route is no longer available via the DSL interface. The device's ISDN interface can take its place further along in the backup chain should the the backup router also fail.

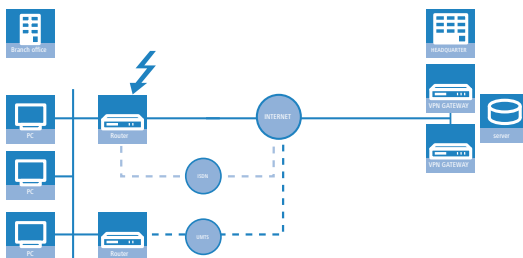

### 16.2.2 Virtual Router Redundancy Protocol

VRRP – Virtual Router Redundancy Protocol – enables multiple physical routers to appear as a single "virtual" router. Of the existing physical routers, one is always the "master". The master is the only router that establishes a data connection to the Internet, for example, and transfers data. The other routers only play a role when the master fails (e.g. due to a hardware defect or because its Internet connection is no longer available). Using the VRRP protocol, which is described in RFC 3768, they negotiate which device should assume the role of master. The new master completely takes over the tasks that were carried out by the previous master.

#### Virtual and physical routers

Dynamic routing protocols such as RIP adapt the entries in dynamic routing tables when, for example, a route is no longer available. When using VRRP, hosts in the LAN can use a static routing table even though the gateway IP address may change, for example, when a device fails due to a defect and another device takes over its functions. VRRP uses "virtual routers" in the routing tables so that the network users always find the right gateway nevertheless. A virtual router is broadcasted in the network with the IP address '192.168.1.100' in the same way as a "normal" router would

be and takes over the function of a gateway to certain remote stations. The actual work of data transfer is carried out by the physical routers behind the virtual router.

- Under normal operating conditions, for example, router A with the IP address '192.168.1.1' establishes the connection to the Internet.
- If router A fails, then router B with the IP address '192.168.1.2' takes over the functions of router A. The network clients do not notice this change; for them, the "virtual" router '192.168.1.100' is still the gateway.

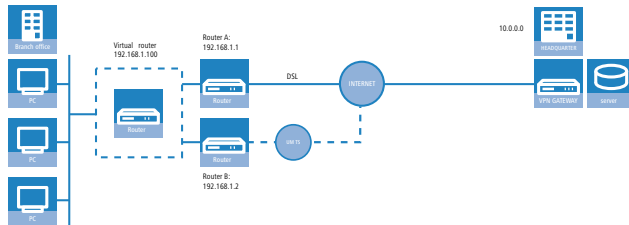

Routing table

IP address	Net mask	Router
10.0.0.0	255.255.0.0	Virtual router

From a more technical standpoint, a router in a network requires a unique MAC address in addition to an IP address. Therefore, when defining a virtual router, a virtual MAC address is defined simultaneously which the virtual router reacts to. The virtual MAC address is formed as '00-00-54-00-01-xx', whereby 'xx' stands for the unique router ID.

In order to determine which physical router reacts to the combination of virtual IP and MAC address, priorities are used for the physical routers. For this purpose, every physical router is assigned a priority. The router with the highest priority takes over the functions of the virtual router as master and thus reacts to the virtual IP and MAC addresses. If two physical routers have the same priority, then the router with the "higher" physical IP address is considered to be the master.

All physical routers report their availability on a regular basis so that, should the current master fail, the router with the next highest priority can take over the routing function at the end of this interval at the latest. If a device determines that it cannot complete the tasks required, it can actively log off before the end of the interval thereby triggering the transfer of the master role to the router with the next priority.

The major advantage of virtual routers is that they enable very flexible scenarios with backup and load balancing functions which remain virtually undetected by the LAN. Clients in the local network randomly select a DHCP server from those available and retrieve the required address information from this server.

### Address assignment via DHCP with more than one DHCP server in the LAN

Several DHCP servers can be operated parallel to each other in a LAN without disrupting one another's functionality. Upon establishing a network connection, the DHCP clients request an IP address selecting one of the available DHCP servers. The DHCP server receiving the request checks to determine whether the address requested is available or already in use within the LAN before assigning the address. This check prevents address conflicts even when several DHCP servers are in use.

For the clients, it is irrelevant which physical router subsequently establishes the data connection. Similarly, the LAN clients do not notice when a router or WAN interface fails due to the fact that, in this case, another router steps in and is available under the same virtual addresses as before.

### Device, connection or remote station backup

A device can disconnect itself from the VRRP group, an option which indicates that the possibilities offered by VRRP are not restricted only to the failure of a device.

VRRP only provides one backup mechanism which safeguards against device failure. In practice, however, the failure of a physical data transfer medium (e.g. DSL, ISDN or UMTS) or the unavailability of a remote station prevent the router from completing its tasks as planned. For this reason, the LANCOM-specific enhancements to VRRP also offer the ability



to define the availability of a remote station as a trigger for the backup event—regardless of whether the data connection is denied due to device, connection or remote station problems.

For the definition of a virtual router, the IP address by which it can be accessed, its priority and its logical router ID are required as a minimum. The router ID serves to ensure that the regular messages from the physical routers can be assigned to the respective virtual routers.

- The router ID can assume a value between 1 and 255. The router ID also reveals the router's virtual MAC address as 00:00:5E:00:01:router ID. The router ID 0 is not permitted.
- The IP address for the virtual router can be chosen freely, however, it must obviously be within the local network. If the virtual router's address is the same as the physical router's address, then the physical router is the "main master" of the system. The main master automatically has the highest priority, that is, when it signals that it is ready for operation, it immediately becomes the active master.
- The priority can assume a value between 1 and 254. The values 0 and 255 have special meanings: With the priority '0', the virtual router is not active, with '255', this virtual router is the main master.

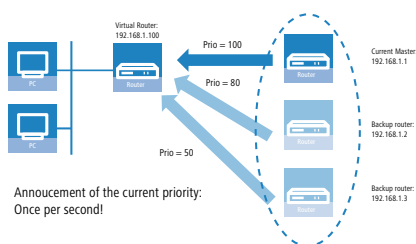

## Router ID defines "standby groups"

The physical routers can be assigned to the virtual routers with the router ID that is determined when defining the virtual router. All devices in which virtual routers are set up with the same router ID form a "standby group" in which the devices can act as replacements for one another. There are three different examples of standby groups:

- In a simple backup scenario, two or more routers form **one** standby group. A virtual router with the same router ID and the same virtual IP address is configured in both physical routers

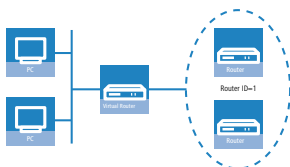

- In order to perform load balancing, the same number of virtual routers with differing IDs and IPs are defined as there are physical routers planned for the VRRP group. For example, two devices would each belong to **two** standby groups

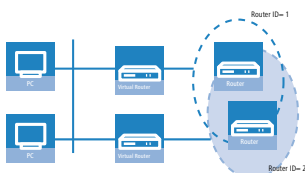

- It is also possible to create more complex combinations with many devices. For example, two devices can form their own standby group with router ID 1 and two other devices can form another group with the ID 2

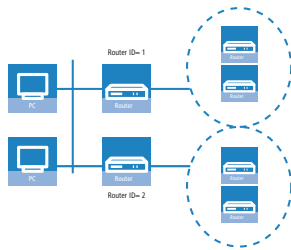

- Depending on the requirements, it is also possible to selectively assign certain devices to a single group while other devices remain members of all groups

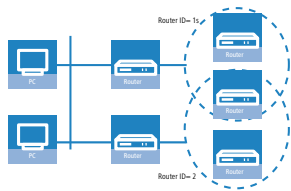

## The Priority System

With the analysis of the priorities, VRRP controls the order in which the physical routers take over the function of the master in a VRRP group. VRRP only considers the failure of an entire device to be a trigger for the backup event.

Since numerous LANCOM devices have more than one WAN interface, the VRRP application in LCOS takes not only the failure of a device but also interruptions to the data connection or the unavailability of a remote station as triggers for the backup event. In order to enable the backup behavior of the LANCOM devices and the formation of backup chains, every virtual LANCOM router is assigned two priorities: a main and a backup priority.

- The main priority is used (propagated into the network) as long as the device is in normal operating condition (i.e. the remote station for the standard connection is still available).
- The backup priority is propagated when the device is in backup mode (i.e. the backup delay has expired and the connection could not be reestablished).
- If '0' is set as the backup priority, the router will not send any signals until the end of the backup event, i.e. the device is not available to the VRRP router group when the remote station is not available.

Since VRRP only knows "priorities" and does not differentiate between main or backup priority, it simply analyzes the priority that is currently being propagated by the device. The device with the currently highest priority is considered to be master.

Normally, priorities are configured so that the main priorities of the devices in a VRRP group are larger than the backup priorities used. However this is a general rule and not a requirement. The main priority of router A can be smaller than the backup priority of another router B. In this case, the backup connection of device B is used **before** the standard connection of router A in the backup chain.

The assignment of priorities to the various WAN interfaces can be determined from the configuration of the backup connections in the backup table (under LANconfig in the configuration area 'Communication' on the 'Call management' tab).

- The main priority refers to the interface on which the standard connection is configured.

- The backup priority refers to the interface on which the backup connection is configured.

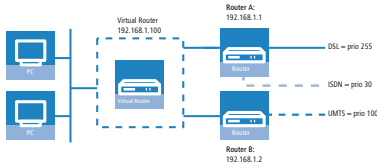

VRRP list router A:

Main prio:	Backup prio:	Remote site
255	30	INTERNET DSL

Backup list router A:

Remote site	Backup list
INTERNET DSL	INTERNET ISDN

VRRP list router B:

Main prio:	Backup prio:	Remote site
100	0	INTERNET UMTS

A master that has been activated due to the priority status will now attempt to establish a connection if this has been configured as a keep alive connection. If the connection is set up as a normal connection with a hold time, then it will not be established until the next packet is transmitted. If this connection fails, thereby triggering the backup event, then the router will also log off and then propagate itself with its backup priority.

## Backup chains

The use of two priorities enables the formation of flexible backup chains by which each physical router does not merely take a single place within the chain but takes a place for every physical WAN interface:

- The first physical router, the main router in the network, has a DSL and an ISDN interface for example, the second router (backup router) has a DSL and a UMTS interface.
- The first router receives the main priority '255'. Consequently, it will become the main router with the value '50' as its backup priority.
- The second router receives the main priority '150' and the value '100' as its backup priority.

Under normal operating conditions, data traffic is processed by the DSL interface on the first router. If the router or this interface fails, the second router attempts (due to the next highest main priority) to establish the connection via its own DSL interface. If this does not succeed, then both devices will propagate their backup priority. Since the second router has the higher backup priority, the connection is established using its UMTS interface. Only when this interface is also unable to establish a connection will the ISDN interface on the first router (with the lower backup priority) be used.

Only keep alive connections return automatically!

The standard connection will only be automatically reestablished after a backup event if the hold time for the connection is configured properly:

- A hold time of "0" means that the connection will not be actively terminated. If the connection is terminated or interrupted due to interference, it will not be automatically established again. The connection will only be reestablished when communication is required of it.
- A hold time of "9999" means that the connection is permanently held open. If it is interrupted, then the connection will be actively opened up again. This behavior is known as **keep alive**.

**Set the hold time to "9999" for connections to the Internet provider (in the corresponding name list) and backed-up VPN connections (in the VPN connection list) to ensure that the connection is automatically reestablished and resumes data transfer after interruption.**

Return to the VRRP group

After an adjustable amount of time (reconnect delay), a router that has logged off attempts to establish its main or backup connection again without propagating its priority first. If the main connection was successfully established, the backup event is terminated and the router returns to propagating its main priority. If only the backup connection was established, then the router falls back into the normal backup event and begins propagating its backup priority again.

As soon as a device can reestablish its main connection, the router begins propagating with its main priority again and becomes the master:

- Devices that are in backup mode with a lower main priority than the active master can also leave backup mode and propagate their main priority due to the fact that their backup connection is not required in this state.
- Devices that are in backup mode with a higher main priority than the active master can remain in backup mode as long as they are not able to establish their higher-prioritized main connection.
- Devices that have completely logged out of the VRRP group due to the unavailability of a VRRP remote site over the backup connection return to the normal backup mode.

### Connection establishment

In order to allow coordinated connection establishment and prevent standby routers from attempting to establish connections, connections from a router are only established when this router:

- is the master **or**
- it is in backup mode and its main connection is configured with a keep alive **or**
- it has completely logged off and the timer for the renewed connection attempt (reconnect delay) expires

This simple rule allows the main connection to be configured as a keep alive connection even in standby routers. It also makes it possible only to use connections with hold time even in the main router.

Connections are always established when all virtual routers connected to the remote site have switched to standby mode. This either happens because another router propagates a higher priority or a LAN connection is lost.

## 16.2.3 Application scenarios

VRRP is normally employed for two different uses:

- In the simple backup case with two routers, one device under normal operation establishes the connection to the Internet. The second device is only operated in wait mode as a "standby device" and takes over the function of the main router should it fail.
- In the second case, two or more devices function parallel to each other as routers in the same network and distribute the incoming data connections using static load balancing. If one of these devices fails, the other router in the group can take over the failed device's functions.

### Backup solution with VRRP

Possibly the most important application of VRRP is the provision of backup connections in which one or more routers serve as backup for the main router. These routers can use different physical media for the Internet connection, such as DSL in the main router and UMTS or ISDN in the backup routers. A normal backup chain thus resembles the following:

- If the DSL connection fails, the UMTS router takes over the function.
- If the UMTS connection fails, the ISDN router takes over the function.

Since almost all LANCOM devices with a DSL interface also have an ISDN interface, the main router can also take over ISDN backup functions at the end of the backup chain—as long as the hardware does not fail completely.

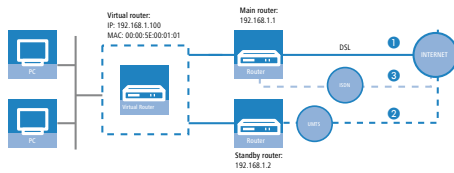

## Load Balancing

With load balancing, several routers exist which can accomplish the same tasks. These routers are pronounced to be the default gateway and evenly distributed among the computers in the LAN using the DHCP server active in every router (see also ). If one of the routers fails, then another can take over its functions providing both routers work with VRRP. On every router, as many virtual routers are defined as there are actual routers. The computers in the LAN are assigned one of the virtual routers as a gateway. Using the virtual router priorities, it is now defined in which order the other routers take over when a master fails. It is also possible to establish a backup chain using the main and backup priority here.

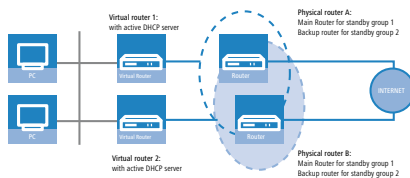

## Example application: Secure Internet access via two DSL/ISDN combination routers

Two load-balancing default gateways that provide security for one another are to be the basis for operating the LAN at two DSL lines. On average, 50% of the LAN stations log in to router 1 and 50% to router 2. The failure of a router or the non-availability of a DSL connection is compensated for by the other router, which takes over the full load.

Under normal operational circumstances, each router handles on average 50% of users in the LAN (prio 250 for the DSL connection). Should a router or DSL connection fail, then the load is distributed to the other router (prio 100 for the DSL connection of the backup router). If both DSL connections fail, then the traffic is directed over the ISDN connections (each with backup prio 50, ISDN connections not illustrated).

Notes for the configuration of the virtual router

Router A		Router B	
	DHCP= On (10.1.1.x)		DHCP= On (10.1.1.x)
Router ID = 1	Router IP = 10.1.1.1	Router ID=1	Router IP=10.1.1.1
	Prio = 250		Prio = 100
	Backup prio=50		Backup prio=50
	Remote station = DSL-INTERNET		Remote station = DSL-INTERNET
	Comment: Main router for group 1		Comment: Backup router for group 1
Router ID = 2	Router IP = 10.1.1.2	Router ID=2	Router IP=10.1.1.2
	Prio = 100		Prio = 250
	Backup prio=50		Backup prio=50
	Remote station = DSL-INTERNET		Remote station = DSL-INTERNET
	Comment: Backup router for group 2		Comment: Main router for group 2

## 16.2.4 Interaction with internal services

When using VRRP virtual routers with virtual IP and MAC addresses are used which, in turn, influences the internal services of LANCOS devices. They must behave differently depending on whether a virtual router or a physical router is addressed. Depending on the service or protocol used, the answers to address requests must be changed or completely denied.

### ARP

The most important protocol when dealing with virtual routers is ARP (Address Resolution Protocol), which provides the ability to match logical addresses such as IP addresses to hardware addresses such as MAC addresses. The use of virtual and physical IP and MAC addresses means that the router's reaction to ARP requests is of great importance:

- An ARP request to the virtual router's address may only be answered when the LANCOS is the master. This request must be answered with the corresponding virtual MAC address. All other requests must be ignored.
- ARP requests that list a virtual router's address as the sender address must be ignored.
- When using proxy ARP, an ARP request must be checked in order to determine if a virtual router is associated with the remote station through which the requested address can be reached. If so, then the request may only be answered when the LANCOS is the master. This also applies to virtual remote stations (i.e. PPTP or VPN) when they use a remote station that is associated with a virtual router as a physical connection.
- ARP requests sent by the LANCOS itself are always sent with the real sender address, as long as this is not the address of a virtual router. In this event, the virtual MAC address must be entered in the ARP request.

### ICMP

When using ICMP, echo requests and replies should be differentiated from error messages. For the error messages, ICMP redirect will require and additional inspection.

- An ICMP echo request directed to the virtual router's address may only be answered by the LANCOS when it is the master.
- ICMP redirects may also be sent from virtual routers but the address of the router to which the packet was sent must be entered as the sender address. This is to be determined from the packet's target MAC address.
- If the LANCOS is addressed via its physical MAC address and the target of the packet is linked to a virtual router, the address of which is connected to the receiving interface, then an ICMP redirect is returned and the sender receives the address of the virtual router.
- For all other error messages, it does not matter whether the virtual router's address or the real address is used as the sender address. To simplify matters, the real address is always used.



With the implementation of VRRP in LANCOS, the previous option 'local routing' in the IP Router menu has been replaced with 'Send ICMP redirects'. If this option is enabled, ICMP redirects are sent, if the option is disabled, the packets are always forwarded.

### DHCP

- Gateway address

Although the computers in the LAN can use ICMP redirects to learn which router is the correct virtual router, it is still advisable to designate the correct router as gateway directly during the DHCP negotiation. This allows the assigning gateway address to be determined as follows:

- If a gateway is explicitly defined for the interface in the DHCP module, then only this will be assigned.
- If no explicit gateway is set, then the default route is looked up in the routing table. If the default route exists and is connected to a virtual router which is directly linked to the interface through which the DHCP request is received, then the virtual router's address is assigned as gateway.
- If other remote sites are linked to virtual routers, then these will not be assigned via DHCP since there can only be one default gateway. A host can only learn the corresponding routers via ICMP redirects.
- Otherwise, the address corresponding to the address pool or interface (intranet or DMZ) will be assigned.

If more than one virtual router is connected by the default route, then the address of the router with the highest priority will be assigned. This allows for automatic load balancing through the selection of the DHCP server by the respective client. The DHCP server is to be activated on all routers involved in load balancing. All routers then define many virtual routers, each with different priorities. If the client randomly selects a DHCP server from those that answer, then it will also be randomly assigned a virtual router.

Example with two routers

LANCOM A defines the following virtual routers:

Router ID	Virt. address	Prio	B Prio	Peer
1	10.0.0.1	100	50	INTERNET
2	10.0.0.2	60	50	INTERNET

and, correspondingly LANCOM B:

Router ID	Virt. address	Prio	B Prio	Peer
1	10.0.0.1	60	30	INTERNET
2	10.0.0.2	100	30	INTERNET

Depending on whether it chooses LANCOM A or LANCOM B, a DHCP client will now be assigned 10.0.0.1 or 10.0.0.2 as gateway and is initially distributed on both LANCOM devices.

Using this example, it becomes clear how load balancing can be combined with backup. If LANCOM A falls into backup mode, then LANCOM B will become the master for all clients. If LANCOM B fails, then LANCOM A will become the master for all clients and will attempt to establish its backup. If this fails, then it is LANCOM B's turn again (this signals the end of the backup chain).

- Further addresses

If the DHCP server is to assign explicit addresses for certain services which the LANCOM provides, such as DNS and NBNS server, then either the configured addresses or the real addresses are assigned to the respective interfaces. Assigning a virtual router violates the RFC which prohibits a virtual router from offering other services (a device may only react to a virtual address when it is also the "owner" of this address, i.e. when the address is also the real interface address. At the same time, this means that DNS and NBNS must receive special treatment.

## DNS server

Since the RFC prohibits a virtual router from offering additional services when the physical router is not the "owner" of the virtual IP address, the LANCOM DNS server requires special treatment. The LANCOM offers two options.

- The solution which conforms to the RFC works in the DNS forwarder. If an external IP address is entered as primary or secondary DNS server, then forwarding to the responsible virtual router functions automatically using the ICMP redirect treatment since the packet is simply forwarded to the virtual router.

However, if no address is entered and no connection has been made to the remote station to which the packet should be forwarded, then the DNS forwarder checks to see if a virtual router is connected to the remote station.

- If this is the case and the LANCOM is also the master for one of the virtual routers, then the connection is established and the packet is forwarded to the DNS server assigned to this connection.
- If the LANCOM is not the master for all connected routers, then the packet is forwarded to the master of the first connected router.

 This procedure only works when all routers behave in accordance with the RFC and use port forwarding. If all of the routers involved are LANCOM devices, then this requirement is fulfilled.

- With the second option, a virtual router reacts to DNS requests itself.

- In order to enable this behavior, the option 'Internal Services' must be enabled. The LANCOM accepts the requests to the internal services (here, for example, DNS) via the virtual addresses as if it had been addressed through one of the physical addresses.
- In the default setting (Off) the LANCOM behaves in accordance with the RFC and drops the corresponding packets.
- The default setting is 'On'.

If a virtual router is connected to the default route when using the internal services, then this will be assigned by the LANCOM DHCP server as the DNS server. If more than one virtual router is connected by the default route, then the router with the highest priority will be assigned (as is the case with gateway addresses).

 This option can only guarantee trouble-free operation if all of the routers involved are LANCOM devices.

### NBNS/NetBIOS proxy

Since a NetBIOS proxy does not forward packets, the question of the virtual or physical addresses responded to is of no significance here. However, it is important that all routers and backup routers in the VRRP group can store the same host, group and server addresses learned from the remote site in their own database and propagate these upon connection establishment. This is the only method of ensuring that an NBNS request can be answered in every case.

Since the NetBIOS proxy propagates all host, group and server addresses learned from the remote site, it need only be ensured that this information is also recorded by the backup routers in their databases. Under normal circumstances, however, this is prevented by the route verification.

Since the transfer of addresses is usually prevented by the route verification, the addresses are only accepted in VRRP operation when **all** of the following requirements are fulfilled:

- There is a WAN route to the propagated address.
- The corresponding remote site is connected to a virtual router.
- The corresponding address is propagated by the master of this virtual router.
- The switch 'Internal Services' is activated.

Only when all of these requirements are fulfilled, will the respective address be accepted in the database. This ensures that the individual router databases remain consistent and all addresses are immediately recognized when a backup router becomes master.

The position of the 'Internal Services' switch influences the NetBIOS proxy.

- When it is enabled, the NetBIOS proxy accepts NBNS requests that are directed to virtual routers.
- If a virtual router is also connected to the default route, then this will be assigned by the LANCOM DHCP server as the NBNS server.
- If more than one virtual router is connected by the default route, then the router with the highest priority will be assigned (as is the case with gateway addresses).

### RIP

The use of VRRP has a particularly strong influence on RIP, through which information on the accessible routes and the corresponding routers is propagated.

- On the one hand, routers must be made known in the network to remote stations which can be reached through a virtual router.
- On the other hand, the routes that are propagated by the virtual routers themselves must be ignored.
- Ultimately, the propagated information is dependent upon the interface which it is to be passed on to.

The announcement of routing information via RIP is governed by the following rules:

- Routes are propagated on all virtual and physical interfaces and every virtual router counts as its own virtual interface.
- If routes are currently being propagated on a physical interface (LAN/DMZ) and a route that must be propagated is connected to a virtual router, then two cases must be differentiated:



- When the virtual router is active on the interface, i.e. its address is in the address range of the respective interface, then the route will not be propagated.
- If the virtual router on the interface is not active, then the route will be propagated normally, i.e. the physical interface address will be propagated as the best route.
- If routes are propagated on a virtual router, then only the routes that are connected to this virtual router may be propagated.
- If routes are propagated on a WAN interface, then all routes are propagated.
- Upon receiving a RIP packet, the sender address of the RIP packet must be taken into consideration. The routes contained in the packet must be ignored when they are propagated by a virtual router known by the LANCOM device.
- If the LANCOM cannot establish a connection to the remote site because all channels are occupied, then RIP propagates the routes accessible through this remote site as "unavailable".
  - In addition, the VRRP module is notified in this case so that it can log off of the router connected to this remote site allowing a new master to be determined.
  - Similarly, VRRP receives notification when the connection is can be re-established in order to allow the virtual router to propagate with its main or backup priority again.

## NTP

When the 'Internal Services' switch is enabled, then the LANCOM also accepts (S)NTP requests that are directed to virtual routers since the exact address of the time source is not relevant for an NTP client.

## Other services

The LANCOM only processes other services when it is addressed via its physical address.

## 16.2.5 VRRP in the WAN

The description of VRRP is only in regard to the LAN portion of data networks and leaves the regulation of the WAN portion to dynamic routing protocols such as RIP. In order to enable WAN failover all the same, LANCOM VRRP provides two alternatives.

### Same IP and MAC addresses

The first possibility entails assigning all of the routers in the VRRP group on the WAN side the same MAC and the same IP address. The routers are then connected to a commonly used DSL line, for example by a switch. In order to avoid address conflicts, only one router may actually react to these addresses on its WAN side, which is achieved through the use of VRRP.

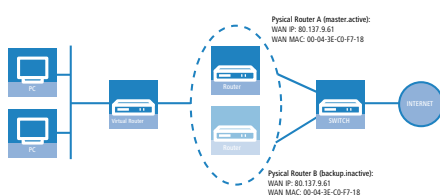

- Due to the fact that the LANCOM terminates its WAN connection when the last virtual router switches to backup mode, this requirement is definitely fulfilled when a total of only one virtual router has been defined.
- In the backup scenario, the necessary requirement is also fulfilled because the main connection is guaranteed to have been terminated or else the backup router would not have become master.

## Routing protocols

In the load balancing scenario, however, there are two different WAN connections online simultaneously, which is why the use of the same MAC and IP address is not possible here. In this case, a routing protocol such as RIP, OSPF or BGP must be used as a second option.

In order to accelerate the switch using RIP, which is rather slow, a LANCOM propagates to all networks that it is no longer available before the connection is established, thereby ensuring a quick change of routing priorities.

## 16.2.6 Configuration

In order to configure failover or load balancing with VRRP, the following parameters can be set:

- **Activation:** The switch 'VRRP activate' enables the VRRP module to be switched on or off (default = off).
- **VRRP list:** In the VRRP list, up to 16 virtual routers can be defined. This table has the following fields:
  - **Router ID:** Unique ID for the virtual router. Values between 1 and 255 are possible. The router ID is used to consolidate several physical routers into a single virtual router or a standby group.
  - **Router IP:** IP address for the virtual router.

---

 All routers on which the virtual router is set up must assign this router the same IP address.

- **Main priority:** The main priority of the virtual router with regard to routers with several interfaces refers to the main interface, i.e. with routers with DSL and ISDN support to the DSL interface. Values between 0 and 255 are permitted. The values 0 and 255 have special meanings:

'0' turns the virtual router off.

- '255' is only accepted when the virtual router address is identical to the address of the interface that is connected to the router. In other cases, the priority is automatically lowered.
- **Backup priority:** The backup priority of the virtual router refers to the interface for which a backup connection is configured, i.e. with routers with DSL and ISDN support to the ISDN interface. Here again, values between 0 and 255 are permitted. The values 0 and 255 also have special meanings here:

0 disables the virtual router in the backup event. Checks are conducted regularly in order to determine whether or not the standard connection can be reestablished. The inspection interval is defined in the reconnect delay.

'255' is only accepted when the virtual router address is identical to the address of the interface that is connected to the router. In other cases, the priority is automatically lowered.

When the backup connection cannot be established in backup mode, then the virtual router logs off completely and attempts to reestablish the standard or backup connection in intervals defined by the reconnect delay.

- **Remote site:** Name of the remote station that controls the virtual router behavior. The remote site can also be assigned to other virtual routers.

---

 Entering the remote site is optional. Linking the backup requirement to a remote site allows the use of the LANCOM-specific enhancement to VRRP not only to secure against device failure (VRRP standard) but also against interface failure or disruption at a remote site.

- **Comment:** 64 character-long commentary describing the virtual router.
- **Reconnect delay:** The reconnect delay time shows after how many minutes a virtual router that has logged off attempts to reestablish its standard connection. The router remains logged off during this connection attempt. It is only broadcasted with its main or backup priority after the connection has been established successfully. The default value is 30 minutes.
- **Advert. interval:** The advertising interval shows how many seconds until a virtual router is propagated again. The default value is 1 second.

---

 With a propagation time of 1 second, the routers in the VRRP group can change quickly when a device or interface fails. An interruption of this type will usually remain undetected due to the fact that the TCP connection is not interrupted. Other routing protocols require up to 5 minutes or longer in order to conduct the transfer to a backup router.

- **Internal services:** The Internal services check box controls how the device should behave when it is addressed via a virtual router address.

- In the 'On' position, the LANCOM reacts to certain services exactly as if it had been addressed via its actual address. Naturally, this only occurs when the device itself is the master of the virtual router. The behavior of the DHCP server changes simultaneously.
- The default setting 'Off' results in behavior in accordance with the RFC, meaning means that the corresponding packets are silently dropped.
- The default setting is 'On'.

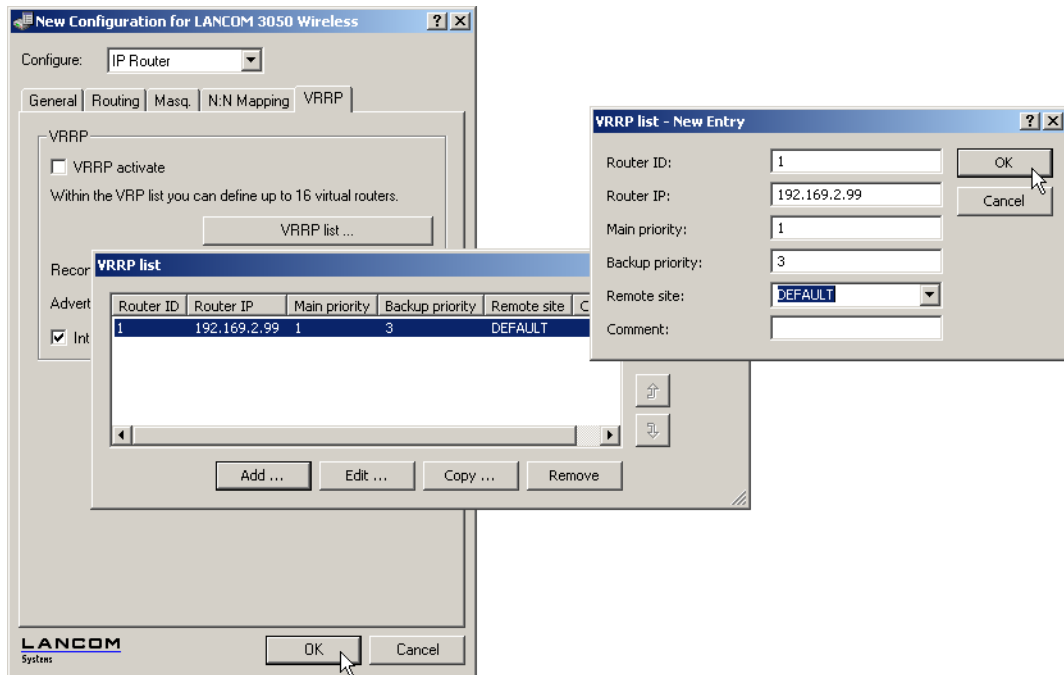

LANconfig: IP router / VRRP

WEBconfig: LCOS menu tree / Setup / IP router / VRRP

## 16.2.7 Status Information

The current status of the devices in the VRRP group is shown in LANmonitor as long as the VRRP module is activated:

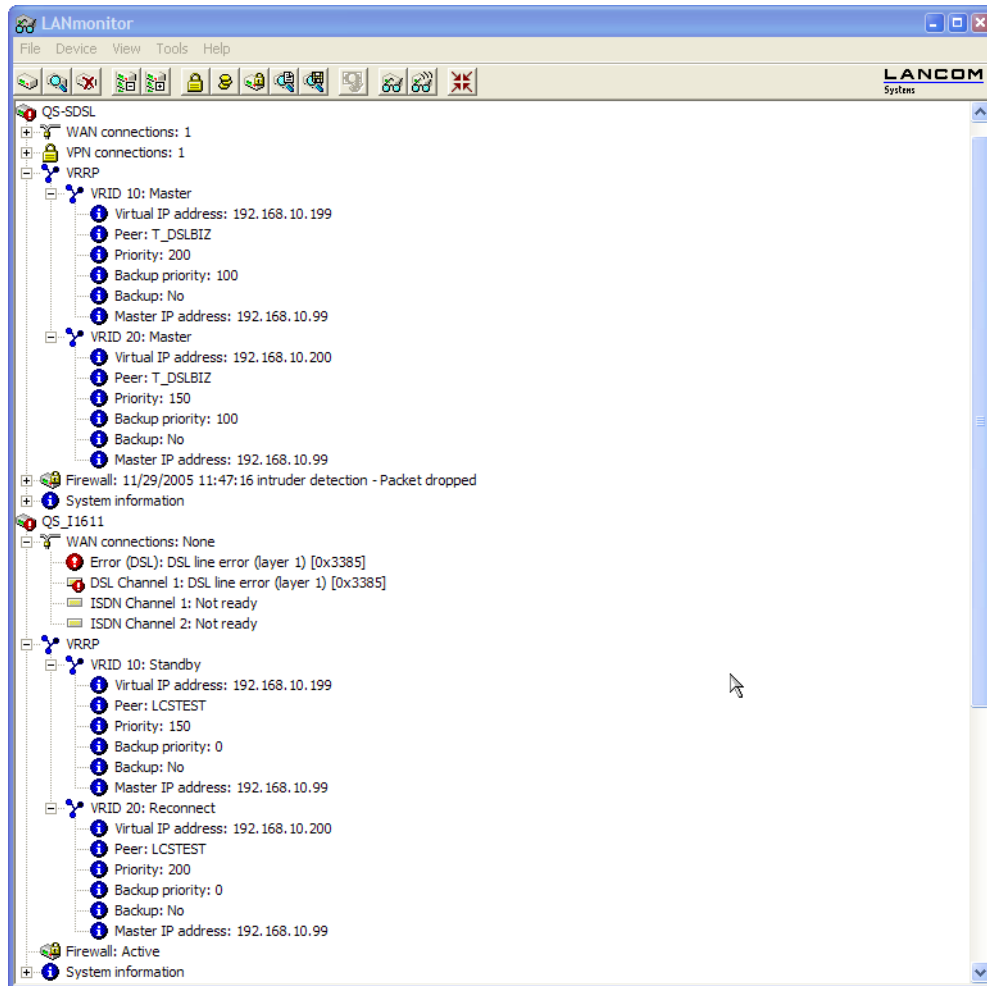

In the device activity log, VRRP events can be viewed in chronological order.

Index	Date	Time	Source	Message
1	29.11.2005	11:43:19	LANmonitor	Start of Activity Log
2	29.11.2005	11:43:19	WAN	DSL Channel 1 -> T_DSLBIZ, Connect
3	29.11.2005	11:45:19	WAN	DSL Channel 1 -> T_DSLBIZ, Disconnect, Charge: 0 units, Time: One hour and 52 minutes
4	29.11.2005	11:45:19	WAN	Error occurred on DSL Channel 1: DSL line error (layer 1) [0x3385]
5	29.11.2005	11:45:29	VRRP	VRID 10: The backup case for the associated remote station has occurred (virtual IP address: 192.168.10.199)
6	29.11.2005	11:45:29	VRRP	VRID 10: The virtual router using the IP address 192.168.10.199 has been disabled
7	29.11.2005	11:45:29	VRRP	VRID 10: The virtual router using the IP address 192.168.10.199 has been enabled
8	29.11.2005	11:45:30	VRRP	VRID 10: The host using the IP address 192.168.10.95 is the new master of the virtual router 192.168.10.199
9	29.11.2005	11:45:31	VRRP	VRID 10: The host using the IP address 192.168.10.150 is the new master of the virtual router 192.168.10.199
10	29.11.2005	11:46:51	WAN	DSL Channel 1 -> T_DSLBIZ, Outgoing call
11	29.11.2005	11:47:07	WAN	Error occurred on DSL Channel 1: Remote site not responding [0x0406]
12	29.11.2005	11:47:08	WAN	DSL Channel 1 -> T_DSLBIZ, Outgoing call
13	29.11.2005	11:47:08	WAN	DSL Channel 1 -> T_DSLBIZ, Protocol
14	29.11.2005	11:47:10	VRRP	VRID 10: The backup case for the associated remote station has been terminated (virtual IP address: 192.168.10.199)
15	29.11.2005	11:47:10	VRRP	VRID 10: The virtual router using the IP address 192.168.10.199 has been enabled
16	29.11.2005	11:47:10	WAN	DSL Channel 1 -> T_DSLBIZ, Connect
17	29.11.2005	11:47:10	VRRP	VRID 10: The host using the IP address 192.168.10.99 is the new master of the virtual router 192.168.10.199

Status information on VRRP can be found in the IP router's status menu and offers the following entries:

- The values Rx and Tx count the VRRP packets received or sent, respectively.
- Error counts all fatal protocol errors that are logged.
- Drop counts all VRRP packets that are dropped, e.g. when a serious error occurred.

In the Virtual Router table, all active virtual routers are listed with their current status. This table has the following fields:

- **Router ID:** Unique ID for the virtual router.
- **Virt. address:** IP address for the virtual router.
- **Prio:** Main priority for the virtual router.
- **B-Prio:** Backup priority for the virtual router.
- **Remote site:** Name of the remote station that controls the virtual router behavior.
- **State:** State of the virtual router. The following states are possible:
  - **Init:** The router is currently being set up.
  - **Listen:** The router is currently learning which device is the master.
  - **Standby:** The router is the standby router.
  - **Master:** The router is the master.
  - **Down:** The router is deactivated.
  - **Reconnect:** The reconnect timer is running and the router is currently not propagating itself.
- **Backup:** Shows if the remote station (peer) is in backup or not. If the remote station is in backup, then the device will propagate its backup priority, otherwise it will propagate its main priority.
- **Master:** Shows which of the physical routers is currently the master.

The MAC list table displays the MAC addresses for the virtual routers that are currently masters. This table has the following fields:

- **Virt. address:** IP address for the virtual router.
- **MAC address:** MAC address for the virtual router.
- **Router ID:** Unique ID for the virtual router.

## 17 Office communication with LANCAPI

 This section only applies to devices with ISDN interface.

LANCAPI from LANCOM Systems is a special version of the popular CAPI interface. CAPI (Common ISDN Application Programming Interface) establishes the connection between ISDN adapters and communications programs. For their part, these programs provide the computers with office communications functions such as a fax machine or answering machine.

### 17.1 What are the advantages of LANCAPI?

The main advantages of using LANCAPI are economic. LANCAPI provides all Windows workstations integrated in the LAN (local-area network) with unlimited access to office communications functions such as fax machines, answering machines, online banking and eurofile transfer. All functions are supplied via the network without the necessity of additional hardware at each individual workstation, thus eliminating the costs of equipping the workstations with ISDN adapters or modems. All you need do is install the office communications software on the individual workstations.

For example, faxes are sent by simulating a fax machine at the workstation. With LANCAPI, the PC forwards the fax via the network to the router which establishes the connection to the recipient.

 Please note: All LANCAPI-based applications access the ISDN directly and do not run across the router of the device. The connect-charge monitoring and firewall functions are thus disabled! The LANCAPI is also independent from all routing or VPN functions.

### 17.2 The client and server principle

The LANCAPI is made up of two components, a server (in the LANCOM) and a client (on the PCs). The LANCAPI client must be installed on all computers in the LAN that will be using the LANCAPI functions.

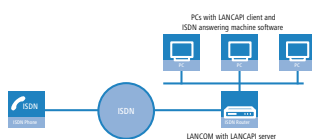

#### 17.2.1 Configuring the LANCAPI server

Two basic issues are important when configuring the LANCAPI server:

- What call numbers from the telephone network should LANCAPI respond to?
- Which of the computers in the local network should be able to access the telephone network via LANCAPI?

The configuration of the router takes place in the configuration tables of LANconfig or WEBconfig. In the following two sections you can find the instructions for both of these configuration programs.

## Configuration with LANconfig

1. Open the configuration of the router by double-clicking on the device name in the list and enter your password if requested.

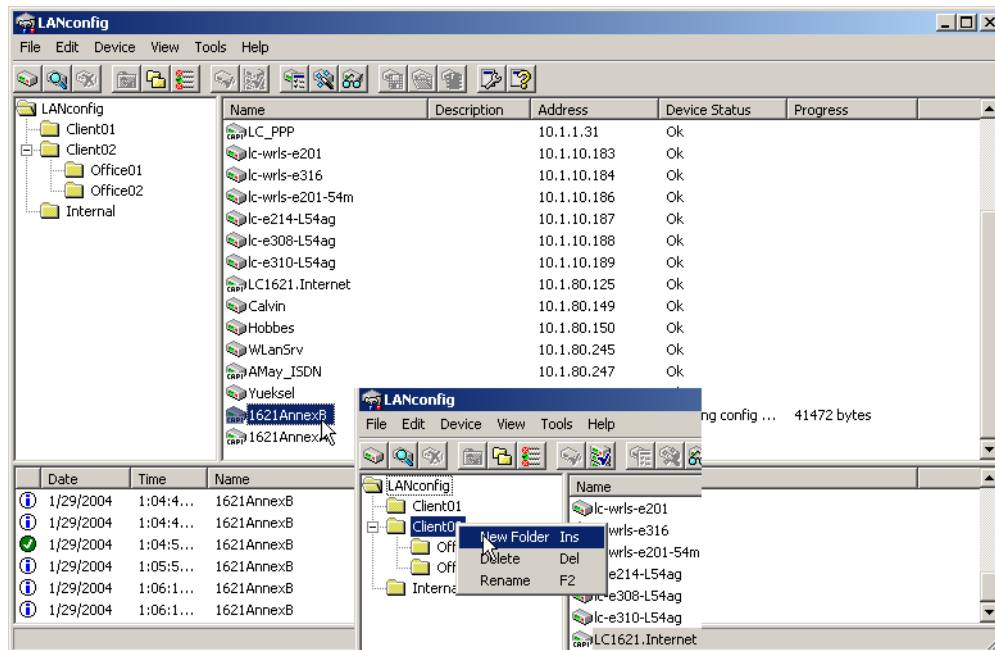

1. In the configuration area 'LANCAPI' click on the tab 'General' and select at the **LANCAPI interfaces** the ISDN port you want to set.

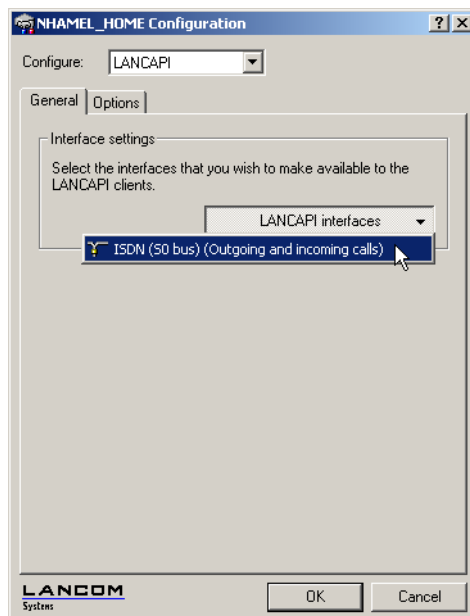

1. Activate the LANCAPI server for the outgoing and incoming calls, or allow only outgoing calls.

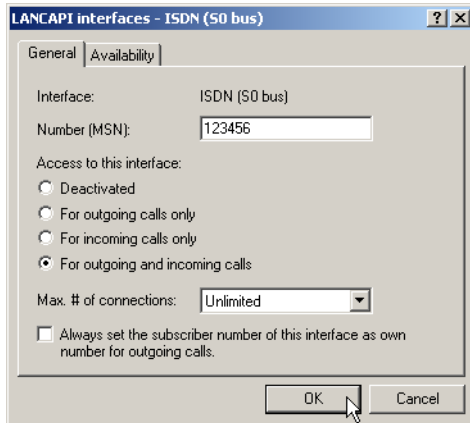

1. If the LANCAPI server is supposed to respond to incoming calls, enter the call numbers to which the LANCAPI should respond in the 'Number (MSN)' field. You can enter several call numbers separated by semicolons. If you do not enter a call number here, all incoming calls are reported to LANCAPI.

### Configuration of WEBconfig

1. Select in the main menu the **LCOS menu tree**.
2. Select in the following menus **Setup / LANCAPI-module / Interface-list**.
3. Select in the **Interface-list** the (only) entry **S0-1**.
4. Activate the LANCAPI server for outgoing and incoming calls ('On'), or only allow outgoing calls ('Dail-only').

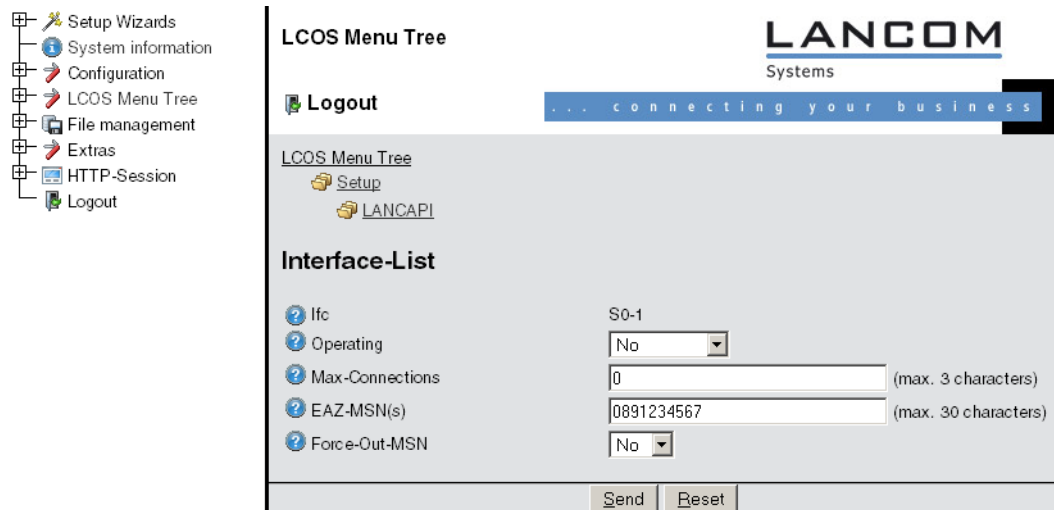

- If the LANCAPI server is supposed to respond to incoming calls, enter the call numbers to which the LANCAPI should respond in the 'Number (MSN)' field. You can enter several call numbers separated by semicolons. If you do not enter a call number here, all incoming calls are reported to LANCAPI.

### 17.2.2 Installing the LANCAPI client

ⓘ For the installation of the LANCAPI client on a system with Windows XP or Windows 2000 administrator rights are required.

1. Place the LANCOM CD in your CD-ROM drive. If the setup program does not automatically start when you insert the CD, simply click 'autorun.exe' in the main directory of the LANCOM CD in the Windows Explorer.



2. Select the Install LANCOM software entry.
3. Highlight the **LANCAPI** option. Click **Next** and follow the instructions for the installation routine.

If necessary, the system is restarted and LANCAPI is then ready to accept all jobs from the office communications software. After successful installation, an icon for LANCAPI will be available in the toolbar. A double-click on this icon opens a status window that permits current information on the LANCAPI to be displayed at any time.

The LANCAPI client starts automatically and shows the status in the windows task bar.

### 17.2.3 Configuration of the LANCAPI clients

The configuration of the LANCAPI clients is used to determine which LANCAPI servers will be used and how these will be checked. All parameters can remain at their default settings if you are using only one LANCOM in your LAN as an LANCAPI server.

1. Start the LANCAPI client in the 'LANCOM' program group. Information regarding the drivers for the available service can be found on the 'General' tab.
2. In the LANCAPI client, change to the **Network** tab. First, select whether the PC should find its own LANCAPI server, or specify the use of a particular server.
  - For the former, determine the interval at which the client should search for a server. It will continue searching until it has found the number of servers specified in the next field. Once the required number of servers has been found, it will stop searching.
  - In the event that the client should not automatically search for servers, list the IP addresses of the servers to be used by the client. This can be useful if you are operating several LANCOM in your LAN as LANCAPI servers and you would like to specify a server for a group of PCs, for example.
  - It is also possible to set the interval at which the client checks whether the found or listed servers are still active.

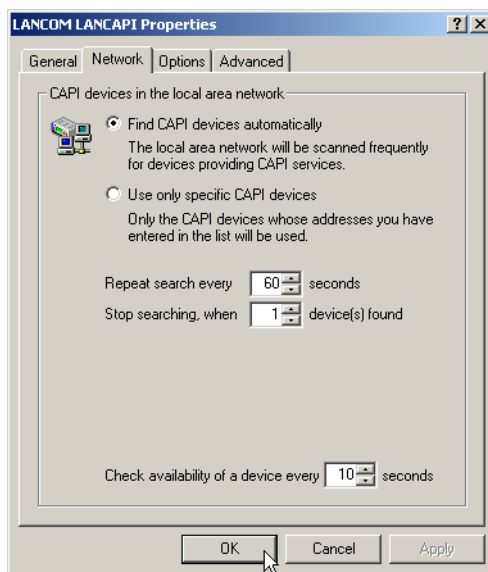

## 17.3 How to use the LANCAPI

Two options are available for the use of the LANCAPI:

- You may use software which interacts directly with a CAPI (in this case, the LANCAPI) port. This type of software searches for the CAPI during its installation and uses it automatically.

- Other programs such as LapLink can establish a variety of connection types, for example, using Windows Dial-Up Networking. You may select the installed communications device that you would like to use when creating a new dial-up connection. For the LANCAPI, select the entry 'ISDN WAN Line 1'.

## 17.4 The LANCOM Systems CAPI Faxmodem

The CAPI Faxmodem provides a Windows fax driver (Fax Class 1) as an interface between the LANCAPI and applications, permitting the use of standard fax programs with an LANCOM. The LANCOM CAPI Faxmodem emulates the modem functions, as well as the fax protocols in the software on the PC. For this purpose an adequate performance (500 MHz Pentium and more) is required.

### 17.4.1 Installation

The CAPI Faxmodem can be installed from the CD setup. Always install the CAPI Faxmodem together with the current version of LANCAPI. After restarting, the CAPI Faxmodem will be available for you, e.g. in Windows 98 under **Start / Settings / Control Panel / Modems**.

### 17.4.2 Faxing with the CAPI Faxmodem

Most major fax programs recognize the CAPI Faxmodem automatically during installation and identify it as a 'Class 1' fax modem. Fax transmissions can thus be realized at speeds of up to 14,400 bps. If your fax program offers you a choice (such as WinFax and Talkworks Pro), select the option 'CLASS 1 (Software Flow Control)' when setting up the modem.

### 17.4.3 Faxing under Windows XP and Windows 2000

Windows XP or Windows 2000 provide with the CAPI Faxmodem full functionality for faxing. An additional fax program is not required.

There to start in the Control Panel under "Add or Remove Programs", "Add/Remove Windows Components" and select "Fax Services".

After the installation the fax can be found under "Printers and Faxes", and can be chosen in any Windows program instead of a printer.

 The CAPI Faxmodem is only able to transmit fax messages, if the LANCAPI is active.

## 17.5 LANCOM Faxmodem option

Additionally to the CAPI Faxmodem some LANCOM models (LANCOM 800, 4000, 4100) have a faxmodem option. With this solution the fax and modem services are implemented in the LANCOM itself, the PCs are released from the load of the modem emulation.

## 17.6 Provided B channel protocols

Following CAPI-Protocols are provided

Value	Remark
B1 protocol	

Value	Remark
0	64 Kbps with HDLC framing
1	64 Kbps transparent with byte framing of the network
2	V.110 asynchron with start-stop-byte framing
4*	T.30-Modem for fax group 3
7*	Modem with full negotiations (B2 has to be 7)
B2-Protocol	
0	ISO 7776 (X.75 SLP)
1	Transparent
4*	T.30 for fax group 3
7*	Modem with full negotiations (e.g. V.42 bis, MNP 5)
9	V.120 asynchron
B3-Protocol	
0	Transparent
1	T.90NL, compatible with T.70NL in accordance with T.90, Appendix II
2	ISO 8208 (X.25 DTE-DTE)
4*	T.30 for fax group 3
5*	T.30 for fax group 3 extended
7*	Modem

\* = valid only for LANCOM faxmodem option

## 18 More services

An LANCOS offers a number of services for the PCs in the LAN. These are central functions that can be used by workstation computers. They are in particular:

- Automatic address administration with DHCP
- Name management of computers and networks with DNS
- Logging of network traffic with SYSLOG
- Recording of charges
- Office communications functions with LANCAPI
- Time server

### 18.1 Automatic IP address administration with DHCP

New in LCOS 7.60:

- BOOTP: Assignment of fixed IP addresses or boot images to specific workstations depending on the IP network (ARF)

#### 18.1.1 Introduction

##### DHCP server

All devices in a local area network require a unique IP address in order for a TCP/IP network to function smoothly. They also require the addresses of DNS and NBNS servers and also of a standard gateway that can route data packets to addresses not located on the local network.

In a small network it is still possible to enter these addresses on all the computers in the network "by hand". However, in a large network with many workstations this soon becomes an unmanageable task. This is where the use of DHCP (dynamic host configuration protocol) comes in. A DHCP server in a TCP/IP-based LAN can use this protocol to assign the required addresses to the individual workstations dynamically.

LANCOS devices have an integrated DHCP server that can assume the task of assigning IP addresses. This process involves communicating the following parameters to the workstations:

- IP address
- Network mask
- Broadcast address
- Standard gateway
- DNS server
- NBNS server
- Lease (validity period) of the assigned parameters

The DHCP server either takes the IP addresses from a freely defined address pool or determines the addresses independently based on its own IP address. A completely unconfigured device in DHCP auto-mode can even specify IP addresses for itself and for network devices autonomously. Therefore in the most basic scenario you only need to connect a new out-of-the-box device to a network without a DHCP server and switch it on. The DHCP server will then manage all further address assignment in the LAN by itself in cooperation with LANconfig using a Wizard.

---

 DHCP settings can be different for each network. It is possible to define several IP networks in the LANCOS devices in conjunction with advanced routing and forwarding (ARF). DHCP settings therefore apply to a particular IP network, with the exception of a few general settings.

## DHCP relay

If another DHCP server is located in the LAN, the device can obtain the address information it requires from the other DHCP server if it is in DHCP client mode.

The LANCOM can also operate as a DHCP relay agent and as a DHCP relay server.

- As a DHCP relay agent the LANCOM forwards DHCP requests to another DHCP server.
- As a DHCP relay server the LANCOM processes DHCP requests forwarded from DHCP relay agents.

## BOOTP

The bootstrap protocol (BOOTP) can be used to send a certain IP address and other parameters to a workstation when it boots up. Workstations without hard drives can use BOOTP to load a boot image, i.e. a complete operating system, from a boot server.

### 18.1.2 Configuring DHCP parameters LANconfig

#### Activating/deactivating a DHCP server for specific logical interfaces

The DHCP server can be activated or deactivated separately for each logical interface (e. g. LAN-1, WLAN-1, P2P-1-1 etc.). To do this, select the appropriate logical interface from the port list and switch the DHCP server on or off for this interface. You can find the parameters for activating the ports in LANconfig in the configuration area "TCP/IP" on the "DHCP" tab.

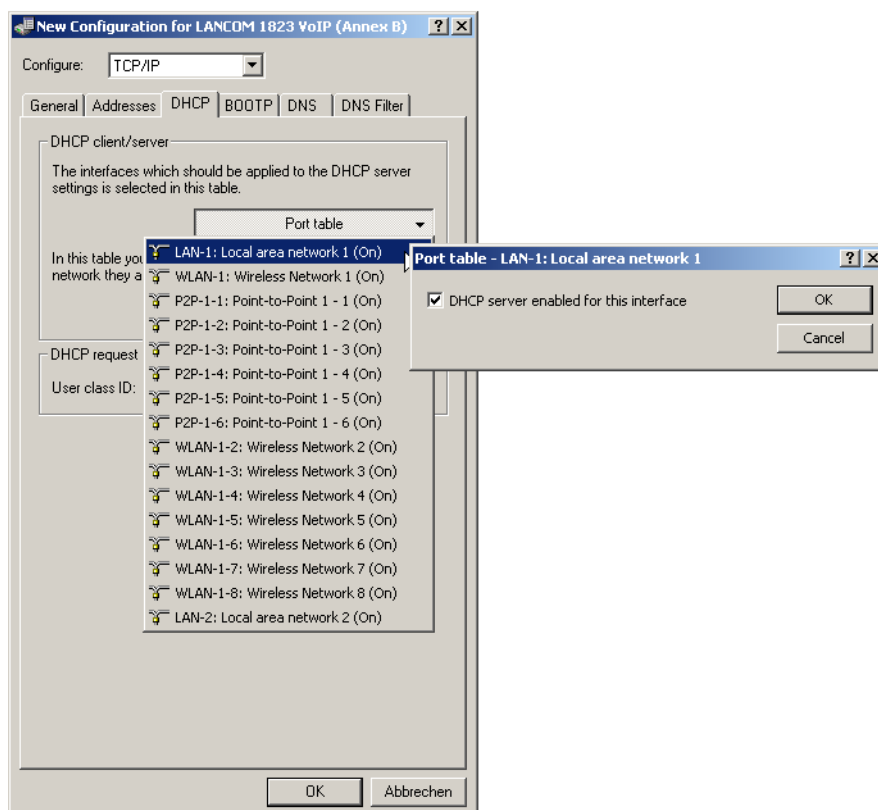

#### Configuring DHCP networks

The appropriate DHCP settings can be specified separately for any IP network defined in the device. You can find the parameters for defining DHCP networks in LANconfig in the configuration area "TCP/IP" on the "DHCP" tab.

When configuring DHCP networks, the addresses are defined that can be assigned to the DHCP clients (address pool). When a client is activated in the network and requests an IP address via DHCP, the device with an activated DHCP server will offer to issue an address. This address is selected from the pool of valid IP addresses. A computer which received an IP address in the past requests this address again and, assuming the DHCP server has not assigned this number to another computer in the meantime, it will attempt to issue this address again.

The DHCP server also checks the LAN to confirm that the selected address is free. Once the address is confirmed as unique, it is assigned to the requesting computer.

**!** The device factory settings include the IP networks 'Intranet' and 'DMZ', although there are no settings for IP addresses and netmasks. The device is in a special operating mode. It then uses the IP address '172.23.56.254' and the address pool '172.23.56.x' for assigning IP addresses to the network.

**!** Multiple networks on one interface: With the configuration of IP and DHCP networks, multiple networks with different DHCP settings can be active at a logical interface. In this case, the DHCP settings for the first suitable network are applied. A prioritization of networks may be necessary here.

- Selecting the IP network

Select the IP network which the subsequent DHCP settings should apply to. You can find the parameters for defining DHCP networks in LANconfig in the configuration area "TCP/IP" on the "General" tab.

- Enabling the DHCP server

The DHCP server can be configured to run in the following modes:

- 'Yes': DHCP server is permanently switched on. When this value is entered the server configuration (validity of the address pool) is checked.
  - If the configuration is correct then the device starts operating as a DHCP server in the network.
  - Errors in the configuration (e.g. invalid pool limits) will cause the DHCP server to be disabled.

**!** Only use this setting if you are certain that no other DHCP server is active in the LAN.

- 'No': DHCP server is permanently switched off.
- 'Auto': With this setting, the device regularly searches the local network for other DHCP servers. The LAN-Rx/Tx LED flashes briefly when this search is in progress.

- If another DHCP server is discovered the device switches its own DHCP server off. If the LANCOM Router is not configured with an IP address, then it switches into DHCP client mode and queries the LAN DHCP server for an IP address. This prevents unconfigured devices introduced to the network from assigning addresses unintentionally.
- If no other DHCP server is discovered the device switches its own DHCP server on. If another DHCP server is activated later, then the DHCP server in the LANCOM Router will be disabled.
- 'Client mode': The DHCP server is disabled, the device behaves as a DHCP client and obtains its address from another DHCP server in the LAN.

---

 Only use this setting if you are certain that another DHCP server is in the LAN and actively assigning IP addresses.

- 'Queries forwarded': The DHCP server is active and receives requests from DHCP clients in the LAN. The device does not respond to requests itself, but forwards them to a central DHCP server in a different network segment.

The DHCP statistics show whether the DHCP server is enabled or not.

The default setting for this parameter is 'Auto'.

- Assigning IP addresses

The DHCP server must first know which IP addresses it can use to assign before it can actually assign them to workstations in the network. There are three different methods for selecting possible addresses:

- An IP address can be taken from the defined address pool (First address: to Last address:). Any address can be entered provided it is valid for the IP network segment.
- If '0.0.0.0' is entered, the DHCP server determines the relevant first and last addresses itself using the settings for the IP network (network address and netmask).
- The device will be in a special operating mode if no IP network has yet been defined. It then uses the IP address '172.23.56.254' and the address pool '172.23.56.x' for assigning IP addresses to the network.

When a client is activated in the network and requests an IP address via DHCP, the device with an activated DHCP server will offer to assign an address. This address is selected from the pool of valid IP addresses. A computer which received an IP address in the past requests this address again and, assuming the DHCP server has not assigned this number to another computer in the meantime, it will attempt to issue this address again.

The DHCP server also checks the LAN to confirm that the selected address is free. Once the address is confirmed as unique, it is assigned to the requesting computer.

- Assigning the netmask

The netmask is assigned in a similar way to assigning addresses. If a netmask has been entered in the DHCP settings, it will be used when assignment is made. Otherwise the IP network's netmask will be used.

- Assigning the broadcast address

As a rule, broadcast packets in a local network have an address which results from the valid IP addresses and the netmask. In special cases (e.g. when using subnets for a selection of workstations) it may be necessary to use a different broadcast address. In this case the broadcast address to be used is entered in the DHCP settings.

---

 We recommend that only experienced network specialists change the pre-setting for the broadcast address. Errors in the configuration here can lead to costly connections being established!

- Assigning the standard gateway

As standard, the LANCOM issues its own IP address as the gateway address to computers making requests. If necessary, the IP address of another gateway can be transmitted if a corresponding address is entered here.

- Assigning DNS and NBNS servers

IP address of the DNS and NBNS name servers to which DNS and NBNS requests should be forwarded.

If no server is defined in the relevant fields, the router will forward its own IP network address as DNS or NBNS address if the DNS server has been enabled for the network in question. If the DNS server is not active for this network, then the IP address in the global TCP/IP settings is communicated as the DNS server.

### Configuring the assignment of fixed IP addresses to specific clients

You can find the parameters for configuring BOOTP in LANconfig in the configuration area "TCP/IP" on the "BOOTP" tab.

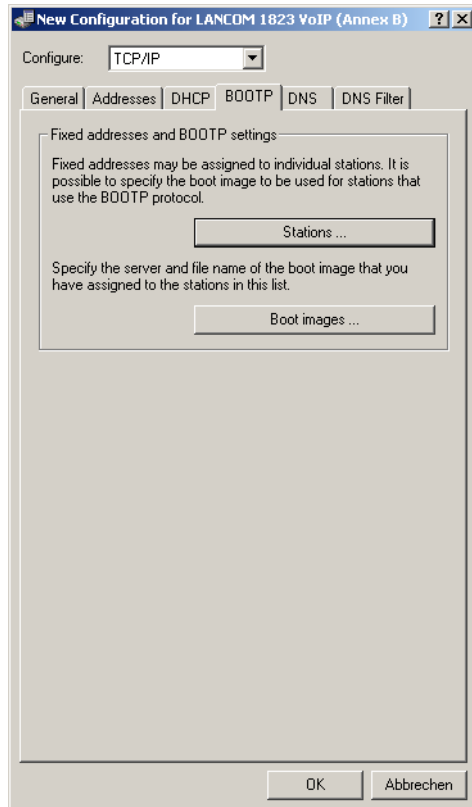

Optionally: You can define a boot image in the list of boot images that you wish to assign to a client.

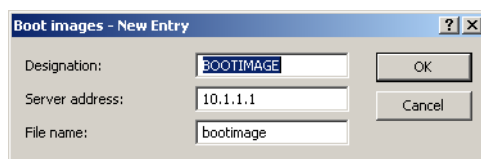

Enter the MAC address of the client that you wish to assign a fixed IP address to in the list of stations. You may also select a boot image that is to be assigned to this client. If this address assignment is only to be used if the client is in a particular IP network, enter the appropriate IP network.

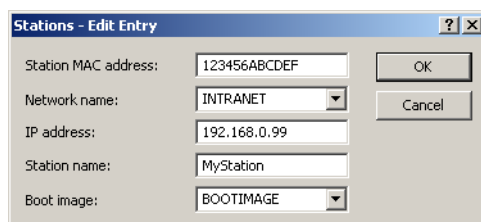



## 18.1.3 Configuring DHCP parameters with telnet or WEBconfig

### General DHCP settings

- User class identifier

The DHCP client in the LANCOM can insert additional information in the DHCP request sent, which simplify request recognition within the network. The vendor class identifier (DHCP option 60) shows the device type, e.g. 'LANCOM L-54ag'. The vendor class ID is always transmitted. The user class ID (DHCP option 77) specifies a user-defined string. The user class ID is only transmitted when the user has configured a value.

- Default lease minutes

When a client requests an address without asking for a specific lease, the address will be assigned the value set here as lease.

- Max. lease minutes

When a client requests an IP address from a DHCP server, it can also ask for a lease for the address. This values governs the maximum length of lease that the client may request.

### Alias list

The alias list defines the names for the boot images that are used to reference the images in the hosts table.

- Image alias

Enter any name you wish for this boot image. This name is used when you assign a boot image to a particular client in the station list.

- Image server

Enter the IP address of the server that provides the boot image.

- Image file

Enter the name of the file on the server containing the boot image.

### DHCP table

The DHCP table provides an overview of the IP addresses used in the IP networks. The DHCP table is purely a status table where no parameters can be configured.

- IP address

IP address used by the client.

- MAC address

The client's MAC address.

- Timeout

Period of validity (lease) for the address assignment in minutes.

- Client name

Name of the client, if it was possible to determine this.

- Type

The 'Type' field indicates how the address was assigned. This field may contain the following values:

- New: The client made the request for the first time. The DHCP checks that the address to be assigned to the client is unique.
- Unknown: When the server checked if the address was unique, it was found that the address had already been assigned to another client. Unfortunately, the DHCP do not have any possibility of obtaining further information about this client.

- Stat: A client has informed the DHCP server that it has a fixed IP address. This address may not be used for any other clients in the network.
  - Dyn.: The DHCP server has assigned an address to the client.
- LAN Ifc  
Logical interface connecting the client to the device.
- Ethernet port  
Physical interface connecting the client to the device.
- VLAN ID  
The VLAN ID used by the client.
- Network name  
Name of the IP network where the client is located.

### Hosts table

The bootstrap protocol (BOOTP) can be used to communicate a certain IP address and other parameters to a workstation when it boots up. For this, the workstation's MAC address is entered into the hosts table.

- MAC address  
Enter the MAC address of the workstation to which an IP address is to be assigned.  
Possible values:
  - Network name  
Enter the name of a configured IP network here. Only if a requesting client is located in this IP network will it be assigned the relevant IP address defined for the MAC address.
- 
-  If the requesting client is located in an IP network for which there is no corresponding entry in the hosts table, the client will be assigned an IP address from the address pool of the appropriate IP network.
- IP address  
Enter the client IP address that is to be assigned to the client.
  - Client name  
Enter the name that is to be used to identify the client. If the client does not communicate its name, the device will use the name entered here..
  - Image alias  
If the client uses the BOOTP protocol, you can select a boot image that the client should use to load its operating system from.

---

 You must enter the server providing the boot image and the name of the file on the server in the boot image table.

### Network list

DHCP settings for the IP networks are defined in this table.

- Network name  
The name of the network which the DHCP server settings apply to.
- DHCP server enabled  
DHCP server operating mode in this network. Depending on the operating mode, the DHCP server can enable or disable itself. You can see whether the DHCP server is enabled from the DHCP statistics.

Possible values:

- No: DHCP server is permanently switched off.
- Automatic: With this setting, the device regularly searches the local network for other DHCP servers. The LAN-Rx/Tx LED flashes briefly when this search is in progress.

If another DHCP server is discovered the device switches its own DHCP server off. If the LANCOM Router is not configured with an IP address, then it switches into DHCP client mode and queries the LAN DHCP server for an IP address. This prevents unconfigured devices introduced to the network from assigning addresses unintentionally.

If no other DHCP server is discovered the device switches its own DHCP server on. If another DHCP server is activated later, then the DHCP server in the LANCOM Router will be disabled.

- 'Yes': DHCP server is permanently switched on. When this value is entered the server configuration (validity of the address pool) is checked.

If the configuration is correct then the device starts operating as a DHCP server in the network.

Errors in the configuration (e.g. invalid pool limits) will cause the DHCP server to be deactivated.

- 'Client mode': The DHCP server is disabled, the device behaves as a DHCP client and obtains its address from another DHCP server in the LAN.
- 'Relay requests': The DHCP server is active and receives requests from DHCP clients in the LAN. The device does not respond to requests, but forwards them to a central DHCP server elsewhere in the network (DHCP relay agent mode).

Default:

- Automatic

---

 Only use the setting "Yes" if you are certain that no other DHCP server is active in the LAN.

---

 Only use the "client mode" setting if you are certain that another DHCP server is in the LAN and actively assigning IP addresses.

- Broadcast bit check

This setting decides whether the broadcast bit from clients is to be checked. If the bit is not checked then all DHCP messages are sent as broadcasts.

- Start address

The first IP address in the pool available to the clients. If no address is entered here the DHCP takes the first available IP address from the network (as determined by network address and netmask).

- End address

The last IP address in the pool available to the clients. If no address is entered here the DHCP takes the last available IP address from the network (as determined by network address and netmask).

- Network mask

Corresponding netmask for the address pool available to the clients. If no address is entered here the DHCP server uses the netmask from the corresponding network.

- Broadcast

As a rule, broadcast packets in a local network have an address which results from the valid IP addresses and the netmask. In special cases (e.g. when using subnets for a selection of workstations) it may be necessary to use a different broadcast address. In this case the broadcast address is entered into the DHCP module.

---

 We recommend that only experienced network specialists change the pre-setting for the broadcast address. Errors in the configuration here can lead to costly connections being established!

- Standard gateway

As standard, the LANCOM issues its own IP address as the gateway address to computers making requests. If necessary, the IP address of another gateway can be transmitted if a corresponding address is entered here.

- DNS default  
IP address of the DNS name server for the forwarding of DNS requests.
- DNS backup  
IP address of the backup DNS name server for the forwarding of DNS requests, in the event that the first name server fails.
- NBNS default  
IP address of the NetBIOS name server for the forwarding of NetBIOS requests.
- NBNS backup  
IP address of the backup NBNS name server for the forwarding of NBNS requests, in the event that the first name server fails.
- Server address  
This is where the IP address for the superordinate DHCP server is entered when the mode 'Relay requests' is selected.
- Caching of server responses  
This option allows the responses from the superordinate DHCP server to be stored in the LANCOM Router. Subsequent requests can then be answered by the LANCOM Router itself. This option is useful if the superordinate DHCP server can only be reached via a connection which incurs costs.
- Adapting server responses to the local network  
This option allows the responses from the superordinate DHCP server to be adapted to the local network. When activated, the LANCOM adapts the responses from the superordinate DHCP server by replacing the following entries with its own address (or locally configured addresses):
  - Gateway
  - Network mask
  - Broadcast address
  - DNS server
  - NBNS server
  - Server ID

This option is worthwhile if the superordinate DHCP server does not permit the separate configuration for DHCP clients in another network.

## Port table

The port table is where the DHCP server is enabled for the appropriate logical interface of the device.

- Path: Setup/DHCP/Ports
- Port  
Select the logical interface for which the DHCP server should be enabled or disabled.
- Enable DHCP  
Enables or disables the DHCP server for the selected logical interface.

## Additional options

DHCP options can be used to send additional configuration parameters to the clients. The vendor class ID (DHCP option 60) shows e. g. the type of device. This table allows additional options for DHCP operations to be defined.

- Option number

Number of the option that should be sent to the DHCP client. The option number describes the transmitted information. For example "17" (root path) is the path to a boot image that a PC without its own hard disk uses to obtain its operating system via BOOTP. You can find a complete list of all DHCP options in RFC 2132 – "DHCP Options and BOOTP Vendor Extensions" of the Internet Engineering Task Force (IETF).

- Network name

Name of the IP network where this DHCP option is to be used.

- Option value

This field defines the contents of the DHCP option. For the option "17", for example, the path is entered for a boot image that a PC without its own hard disk uses to obtain its operating system via BOOTP.

 The maximum possible length value depends on the selected option number. RFC 2132 lists the maximum length allowed for each option.

## 18.1.4 DHCP relay server

A LANCOM is not limited to forwarding DHCP requests to superordinate DHCP servers; it can also function as a central DHCP server (DHCP relay server).

In order for a LANCOM to be provided as a DHCP relay server to other networks, the relay agent IP address (GI address) is entered as the network name in the table of IP networks.

If the same network is being used by several relay agents (e.g. multiple access points are forwarding requests to a central DHCP server) then the GI address can also be abbreviated with a "\*". If for example clients in the remote network '10.1.1.0/255.255.255.0' are to be assigned with addresses and several relay agents are available in this network, all of which use the LANCOM as superordinate DHCP server, then the assignment of IP addresses and standard gateway to the clients can take place as follows:

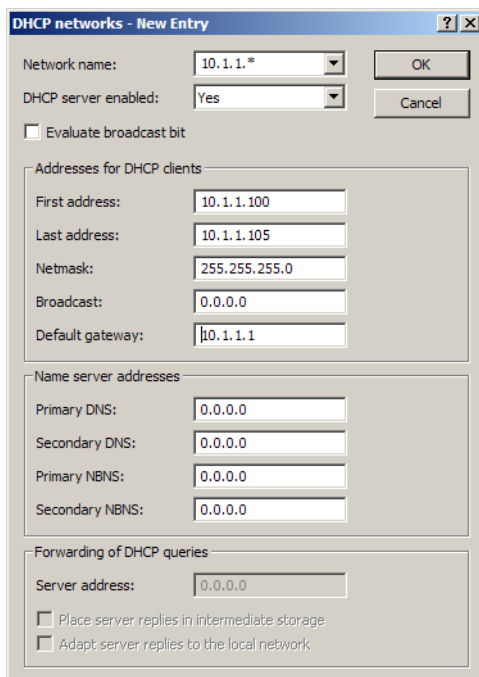

 To operate as DHCP relay server, it is imperative that the address pool and the netmask are given.

### DNS resolution of names learned via DHCP

The DNS server considers the interface tags when resolving names learned via DHCP, i.e. the only names to be resolved are those which were learned from a network with the same interface tag as the requesting computer. If the request

arrives from an untagged network, then all names are resolved, including those that were learned via tagged networks. Similarly, all names that were learned from untagged networks are visible for tagged networks.

Names learned from relay agents are handled as though they were learned from an untagged network, i.e. these names are visible to all networks.

### 18.1.5 Configuring clients

It is standard in a Windows network environment for nearly all settings to be configured in such a way that required parameters can be requested via DHCP. You can check your Windows settings by clicking on **Start / Settings / Control Panel E Network**. Select the entry for **TCP/IP** on your network adapter and open **Properties**. You can now see on the various tabs whether there are special entries for e.g. the IP address or the standard gateway. If you wish to have all the values assigned by the DHCP server, just delete the corresponding entries.

If a client is to use a different parameter from the one assigned (e.g. for a standard gateway), this parameter must be configured at the workstation itself. The client will then ignore the corresponding parameter(s) in those assigned by the DHCP server.. Under Windows this can be effected for example via the properties of the network environment. Click on **Start / Settings / Control Panel / Network**. Select the entry for 'TCP/IP' on your network adapter and open **Properties**. You can now enter the desired values on the various tabs.

### 18.1.6 Checking IP addresses in the LAN

You can view a summary of the LAN IP addresses in the DHCP table (WEBconfig: Setup/DHCP/DHCP Table). It shows the assigned and used IP address, the MAC address, the lease, the client's name (if available) as well as the type of address assignment.

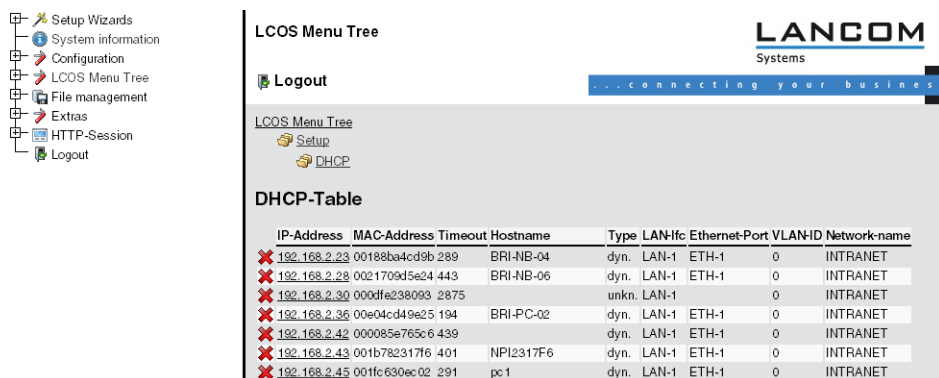

The screenshot shows the LANCOM web interface with the DHCP-Table expanded. The table contains the following data:

IP-Address	MAC-Address	Timeout	Hostname	Type	LAN-Ifc	Ethernet-Port	VLAN-ID	Network-name
192.168.2.23	00188ba4cd9b	289	BRI-NB-04	dyn.	LAN-1	ETH-1	0	INTRANET
192.168.2.28	0021709d5e24	443	BRI-NB-06	dyn.	LAN-1	ETH-1	0	INTRANET
192.168.2.30	000dfe238093	2875		unkn.	LAN-1		0	INTRANET
192.168.2.36	00e04cd49e25	194	BRI-PC-02	dyn.	LAN-1	ETH-1	0	INTRANET
192.168.2.42	000085e765c6	439		dyn.	LAN-1	ETH-1	0	INTRANET
192.168.2.43	001b782317f6	401	NPI2317F6	dyn.	LAN-1	ETH-1	0	INTRANET
192.168.2.45	001fc630ec02	291	pc1	dyn.	LAN-1	ETH-1	0	INTRANET

### 18.1.7 Addition(s) to LCOS 7.80

#### DHCP cluster

##### Introduction

If multiple DHCP servers are active in a network, the stations "divide" themselves equally between them. However, the DNS server in LANCOM devices can only properly resolve the name of the station which was assigned the address information by the DHCP server. In order for the DNS server to be able to resolve the names of other DHCP servers, these can be operated in a cluster. In this operating mode, the DHCP server monitors all DHCP negotiations in the network. It additionally supplements its table with the stations which are registered at the other DHCP servers in the cluster.

##### Configuration

A DHCP server's operation in the cluster can be activated or deactivated for each individual ARF network with the associated DHCP settings.

WEBconfig: LCOS menu tree / Setup / DHCP / Network list

- Cluster

This setting defines whether the DHCP server for this ARF network is to be operated separately or in the cluster.

Possible values:

- Yes: With cluster mode activated, the DHCP server monitors all of the ongoing DHCP negotiations in the network, and it additionally supplements its table with the stations which are registered at the other DHCP servers in the cluster. These stations are flagged as "cache" in the DHCP table.
- No: The DHCP server manages information only for the stations connected to it.

Default:

- No

 If the lease time for the information supplied by DHCP expires, the station requests a renewal from the DHCP server which supplied the original information. If the original DHCP server does not respond, the station then emits its rebinding request as a broadcast to all available DHCP servers. DHCP servers in a cluster ignore renew requests, which forces a rebinding. The resulting broadcast is used by all of the DHCP servers to update their entries for the station. The only DHCP server to answer the rebind request is the one with which the station was originally registered. If a station repeats its rebind request, the all DHCP servers in the cluster assume that the original DHCP server is no longer active in the cluster, and they respond to the request. The responses received by the station will have the same IP address, but the gateway and DNS server addresses may differ. From these responses, the station selects a new DHCP server to connect with, and it updates its gateway and DNS server (and other relevant parameters) accordingly.

## DHCP options with LANconfig

DHCP options can be used to send additional configuration parameters to the clients. The vendor class ID (DHCP option 60) shows e. g. the type of device. This table allows additional options for DHCP operations to be defined.

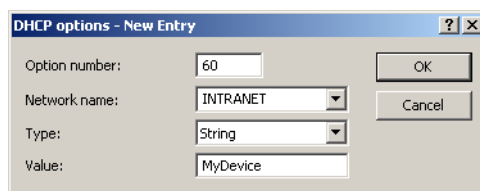

LANconfig: TCP/IP / DHCP / DHCP-Options

WEBconfig: LCOS menu tree / Setup / DHCP / Additional options

- Option number

Number of the option that should be sent to the DHCP client. The option number describes the transmitted information. For example "17" (root path) is the path to a boot image that a PC without its own hard disk uses to obtain its operating system via BOOTP.

Possible values:

- Maximum 3 characters.

Default:

- Blank

 You can find a list of all DHCP options in RFC 2132 – "DHCP Options and BOOTP Vendor Extensions" of the Internet Engineering Task Force (IETF).

- Network name

Name of the IP network where this DHCP option is to be used.

Possible values:

- Selection from the list of IP networks defined in the device; max. 16 characters

Default:

- Blank

- Type

Entry type. This value depends on the respective option. For option "35" according to RFC 1232, e.g. the ARP cache time is defined as follows:

ARP cache timeout option

This option specifies the timeout in seconds for ARP cache entries.

The time is specified as a 32-bit unsigned integer.

The code for this option is 35, and its length is 4.

Code Len Time

```
+-----+-----+-----+-----+-----+-----+
| 35 | 4 | t1 | t2 | t3 | t4 |
+-----+-----+-----+-----+-----+-----+
```

This description tells you that this the type "32-bit integer" is used for this option.

Possible values:

- String, Integer8, Integer16, Integer32, IP address

Default:

- String



You can find out the type of the option either from the corresponding RFC or from the manufacturer's documentation of their DHCP options.

- Value

This field defines the contents of the DHCP option.

IP addresses are specified with the usual notation for IPv4 addresses, e.g. as "123.123.123.100", integer types are entered as normal decimal numbers, and strings as simple text.

Multiple values in a single field are separated with commas, e.g. "123.123.123.100, 123.123.123.200".

Possible values:

- Maximum 128 characters.

Default:

- Blank



You can find out the possible length of the option value either from the corresponding RFC or from the manufacturer's documentation of their DHCP options.



## 18.1.8 Addition(s) to LCOS 8.00

### Alternative DHCP server for forwarding

#### Introduction

The DHCP server offers various operating modes. In the forwarding mode, the device acts in the local network like a DHCP relay and forwards requests to one of more pre-defined DHCP servers. This setting facilitates the operation of central DHCP servers in another network.

All DHCP messages sent by DHCP clients as a broadcast are forwarded to all predefined DHCP servers. The client selects the first server to answer and sends all subsequent messages as unicasts directly to that server. If the selected server becomes unavailable, the client once again transmits broadcast messages and selects another DHCP server.

#### Configuration

To configure the DHCP server for forwarding, refer to the following menus:

- LANconfig: TCP/IP / DHCP / DHCP networks
- WEBconfig: LCOS menu tree / Setup / DHCP / Network list

- 1st server address

This is where the IP address for the upstream DHCP server is entered when the mode 'Relay requests' is selected.

Possible values:

- IP address or the broadcast address of the network in which the server is located. The broadcast address is the highest address in an IP network. All packets sent to this address are received by all hosts.

Default:

- 0.0.0.0

### 18.1.9 Addition(s) to LCOS 8.80

#### Displaying status information from the DHCP server

The status table of the DHCP server shows the following information about the devices that to which the DHCP server has assigned IP addresses:

- IP address, which the DHCP server has assigned to the network device
- MAC address of the network device
- Timeout, remaining validity period in minutes
- Computer name
- Type of address assignment, dynamic or from cache
- LAN-Ifc, logical interface over which the DHCP server assigned the IP address to the network device
- Ethernet port, physical interface over which the DHCP server assigned the IP address to the network device
- VLAN ID of the network
- Network name
- Assignment, date and time when the DHCP server assigned the IP address to the network device

You can find the status information for the DHCP server at the following locations:

- Telnet: /Setup/DHCP/DHCP-Table

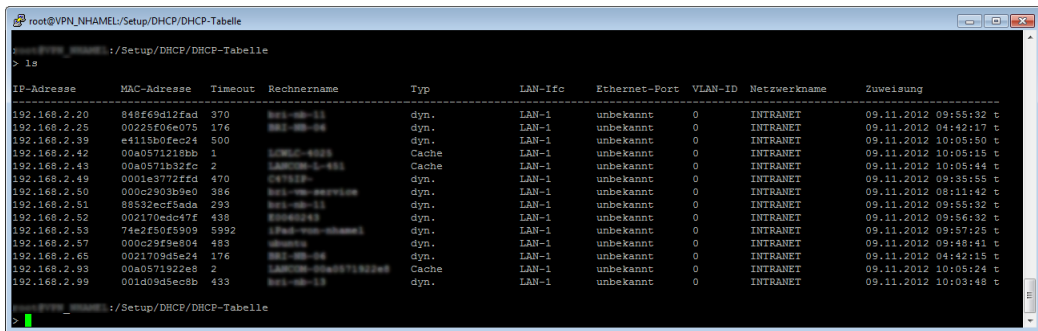

- WEBconfig: /Setup/DHCP/DHCP-Table

LCOS Menu Tree

- Setup
  - DHCP

#### DHCP-Table

IP-Address	MAC-Address	Timeout	Hostname	Type	LAN-Ifc	Ethernet-Port	VLAN-ID	Network-name	Assignment
✘ 192.168.2.20	848f69d12fad	269	bri-nb-11	dyn.	LAN-1	unknown	0	INTRANET	11/23/2012 13:23:16 tics
✘ 192.168.2.21	c09f42b46ace	5994		dyn.	LAN-1	unknown	0	INTRANET	11/23/2012 14:01:44 tics
✘ 192.168.2.25	00225f06e075	87	BRI-NB-06	dyn.	LAN-1	unknown	0	INTRANET	11/23/2012 07:37:17 tics
✘ 192.168.2.39	e4115b0fec24	499		dyn.	LAN-1	unknown	0	INTRANET	11/23/2012 14:07:15 tics
✘ 192.168.2.42	00a0571218bb	1	LCWLC-4025	cache	LAN-1	unknown	0	INTRANET	11/23/2012 14:07:01 tics
✘ 192.168.2.43	00a0571b32fc	1	LANCOM-00a0571b32fc	cache	LAN-1	unknown	0	INTRANET	11/23/2012 14:06:50 tics
✘ 192.168.2.48	00159976eab8	4158		unkn.	LAN-1	unknown	0	INTRANET	11/22/2012 07:26:11 tics
✘ 192.168.2.49	0001e3772ffd	393	C475IP-	dyn.	LAN-1	unknown	0	INTRANET	11/23/2012 12:20:41 tics
✘ 192.168.2.50	000c2903b9e0	393	bri-vm-service	dyn.	LAN-1	unknown	0	INTRANET	11/23/2012 12:21:09 tics
✘ 192.168.2.51	002170edc47f	258	E0060243	dyn.	LAN-1	unknown	0	INTRANET	11/23/2012 12:08:54 tics
✘ 192.168.2.53	74e2f50f5909	5755	iPad	dyn.	LAN-1	unknown	0	INTRANET	04/22/1900 21:33:20 tics
✘ 192.168.2.57	000c29f9e304	450	ubuntu	dyn.	LAN-1	unknown	0	INTRANET	11/23/2012 13:18:18 tics

- LANmonitor: Broken down by network name under DHCP-server > Network list

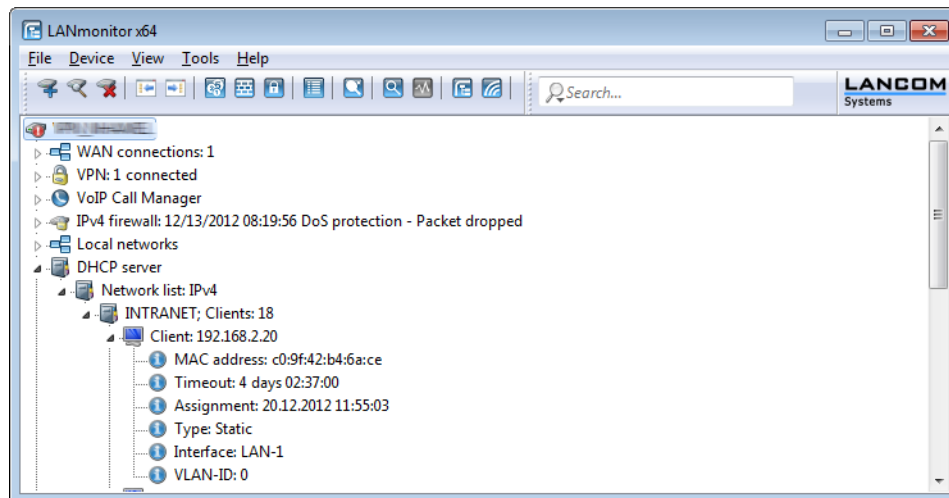

## 18.2 Vendor Class and User Class Identifier

The DHCP client in LANCOM can insert additional information in the DHCP request sent, which simplify request recognition within the network.

- The vendor class identifier (DHCP option 60) shows the device type, e.g. 'LANCOM L-54'. The vendor class ID is always transmitted.
- The user class identifier (DHCP option 77) displays a user-defined string, which can be entered under `Setup/DHCP` or in LANconfig in the configuration area under 'TCP/IP' on the 'DHCP' tab in the 'User Class ID' field (default: empty). The user class ID is only transmitted when the user has configured a value.

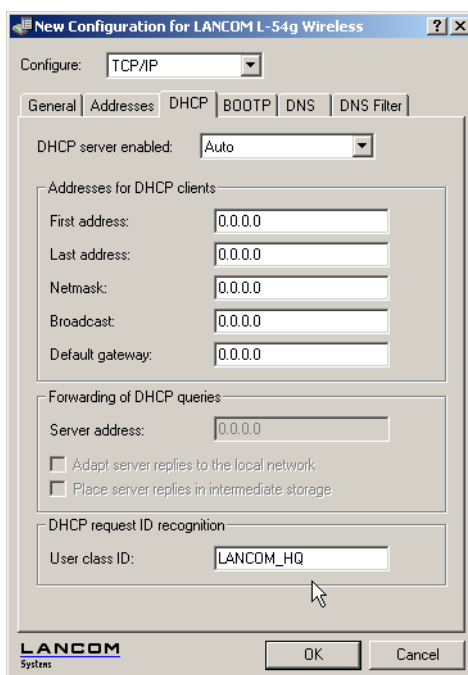

## 18.3 DNS

The domain name service (DNS) is responsible in TCP/IP networks for associating computer names and/or network (domains) and IP addresses. This service is required for Internet communications, to return the correct IP address for a request such as 'www.lancom.de' for example. However, it's also useful to be able to clearly associate IP addresses to computer names within a local network or in a LAN interconnection.

### 18.3.1 What does a DNS server do?

The names used in DNS server requests are made up of several parts: one part consists of the actual name of the host or service to be addressed; another part specifies the domain. Specifying the domain is optional within a local network. These names could thus be 'www.domain.com' or 'ftp.domain.com', for example.

If there is no DNS server in the local network, all locally unknown names will be searched for using the default route. By using a DNS server, it's possible to immediately go to the correct remote station for all of the names with known IP addresses. In principle, the DNS server can be a separate computer in the network. However, the following reasons speak for locating the DNS server directly in the LANCOM:

- LANCOM can automatically distribute IP addresses for the computers in the local network when in DHCP server mode. In other words, the DHCP server already knows the names and IP addresses of all of the computers in its own network that were assigned IP addresses via DHCP. With the dynamic address assignments of a DHCP server, an external DNS server might have difficulties in keeping the associations between the names and IP addresses current.
- When routing Microsoft Networks via NetBIOS, the LANCOM also knows the computer names and IP addresses in the other connected NetBIOS networks. In addition, computers with fixed IP addresses can also enter themselves in the NetBIOS table and thus be known by their names and addresses.
- The DNS server in the LANCOM can also be used as an extremely convenient filter mechanism. Requests for domains can be prohibited throughout the LAN, for subnetworks, or even for individual computers—simply by specifying the domain name.

### How does the DNS server react to the request?

When processing requests for specific names, the DNS server takes advantage of all of the information available to it:

- First, the DNS server checks whether access to the name is not prohibited by the filter list. If that is the case, an error message is returned to the requesting computer stating that access to the address has been denied.
- Next, it searches in its own static DNS table for suitable entries.
- If the address cannot be found in the DNS table, it searches the dynamic DHCP table. The use of DHCP information can be disabled if required.
- If no information on the name can be located in the previous tables, the DNS server then searches the lists of the NetBIOS module. The use of the NetBIOS information can also be disabled if necessary.
- Finally, the DNS server checks whether the request to another DNS server is to be forwarded to another DNS server via a WAN interface (special DNS forwarding via the DNS destination table).

If the requested name cannot be found in any of the information sources available to it, the DNS server sends the request to another server—that of the Internet provider, for example—using the general DNS forwarding mechanism, or returns an error message to the requesting computer.

### 18.3.2 DNS forwarding

If it cannot serve the request from its own DNS tables, the DNS server forwards the request to other DNS servers. This process is called DNS forwarding.

Here a distinction is made between

- special DNS forwarding Requests for certain name areas are forwarded to certain DNS servers.
- general DNS forwarding All other names not specified in detail are forwarded to the "higher-level" DNS server.

## Special DNS forwarding

With "special DNS forwarding" name areas can be defined for the resolution of which specified DNS server are addressed.

A typical application for special DNS forwarding results for a home workstation: The user wants to be able to connect to the company intranet and directly to the Internet at the same time. The requests sent into the intranet must be routed to the company DNS server, and all other requests to the DNS server of the provider.

## General DNS forwarding

All DNS requests that cannot be resolved in another way are forwarded to a DNS server. This DNS server is determined according to the following rules:

- Initially the router checks whether a DNS server has been entered in its own settings. If it is successful there, it obtains the desired information from this server. Up to two higher-level DNS servers can be specified.

LANconfig: TCP/IP / Addresses / Primary DNS / Secondary DNS

WEBconfig: LCOS menu tree / Setup / TCP-IP / DNS-default / DNS-backup

- If no DNS server is entered in the router, it will attempt to reach a DNS server over a PPP connection (e.g. from the Internet provider) to get the IP address assigned to the name from there. This can only succeed if the address of a DNS server is sent to the router during PPP negotiation.
- The default route is established and the DNS server searched for there if no connection exists.

This procedure does not require you to have any knowledge of the DNS server address. Entering the Intranet address of your router as the DNS server for the workstation computers is sufficient to enable you obtain the name assignment. This procedure also automatically updates the address of the DNS server. Your local network always receives the most current information even if, for example, the provider sending the address changes the name of his DNS server or you change to another provider.

### 18.3.3 Setting up the DNS server

The settings for the DNS server are contained in the following menu or list:

LANconfig:TCP/IP / DNS

WEBconfig: LCOS menu tree / Setup / DNS

Proceed as follows to set the DNS server:

1. Switch the DNS server on.
2. Enter the domain in which the DNS server is located. The DNS server uses this domain to determine whether the requested name is located in the LAN. Entering the domain is optional.

- Specify whether information from the DHCP server and the NetBIOS module should be used.

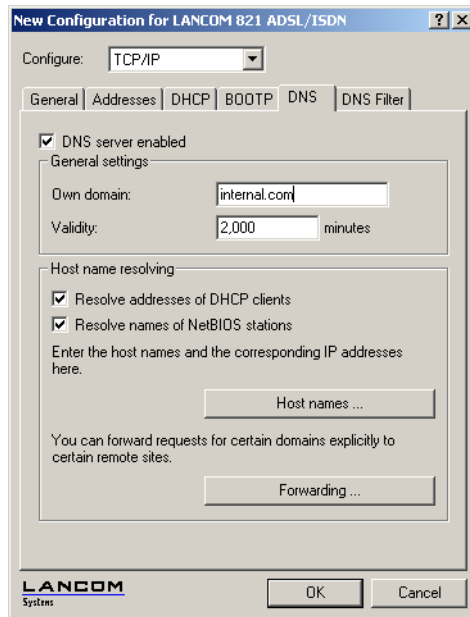

- The main task of the DNS server is to distinguish requests for names in the Internet from those for other remote stations. Therefore, enter all computers in the Host names table,
  - for which you know the name and IP address,
  - that are not located in your own LAN,
  - that are not on the Internet and
  - that are accessible via the router.

For example, if you would like to access the mail server at your headquarters (name: mail.yourdomain.com, IP: 10.0.0.99) via the router from a branch office, enter:

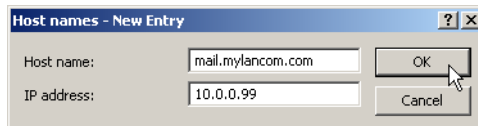

Stating the domain is optional but recommended.

When you now start your mail program, it will probably automatically look for the server 'mail.yourdomain.com'. The DNS server thereupon returns the IP address '10.0.0.99'. The mail program will then look for that IP address. With the proper entries in the IP routing table and peer list, a connection is automatically established to the network in the headquarters, and finally to the mail server.

- To resolve entire name areas of another DNS server, add a forwarding entry consisting of a name area and remote station:

When entering the name areas, the wildcards '?' (for individual characters) and '\*' (for multiple characters) may be used.

To reroute all domains with the ending '.intern' to a DNS server in the LAN of the remote station 'COMPANY', create the following entry:

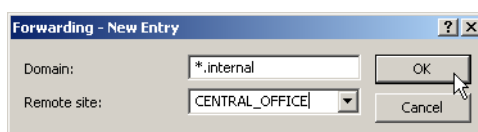

- ! The DNS server may either be specified by the remote site name (for automatic setting via PPP), or by an explicit IP address of the according name server.

### 18.3.4 URL blocking

- Finally, one can restrict access to certain names or domains with the filter list.

To block the domain (in this case the web server) 'www.offlimits.com' for all computers in the LAN, the following commands and entries are required:

LANconfig: TCP/IP / DNS Filter / DNS filter... / Add

WEBconfig: ... / Filter-list / Add

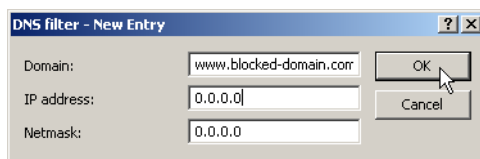

The index '001' in the console command can be selected as desired and is used only for clarity.

- ! When entering the domains, the wildcards '?' (represents exactly one character) and '\*' (for any number of characters) are permitted.

To only block the access of a certain computer (e.g. with IP 10.0.0.123) to COM domains, enter the following values:

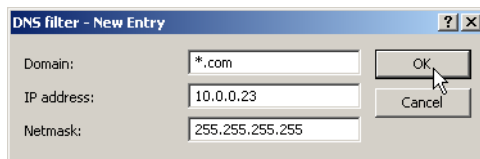

In the console mode the command is:

```
set 002 *.com 10.0.0.123 255.255.255.255
```

- ! The hit list in the DNS statistics contains the 64 most frequently requested names and provides a good basis for setting up the filter list.

If your LAN uses subnetting, you can also apply filters to individual departments by carefully selecting the IP addresses and subnet masks. The IP address '0.0.0.0' stands for all computers in the network, and the subnet mask '0.0.0.0' for all networks.

### 18.3.5 Dynamic DNS

Systems with dynamic IP addresses become accessible over the WAN - for example over the Internet - via so-called Dynamic DNS service providers, e.g. [www.dynDNS.org](http://www.dynDNS.org).

Thereby a LANCOM becomes available under a certain DNS-resolvable name (FQDN - 'fully qualified Domain Name', for example "http://MyLANCOM.dynDNS.org").

The advantage is obvious: If you want to accomplish e.g. remote maintenance for a remote site without ISDN available (e.g. over WEBconfig/HTTPS), or to connect with the LANCOM VPN Client to a branch office with dynamic IP address, then you just need to know the appropriate Dynamic DNS name.

## How to deposit the current IP address at the Dynamic DNS server?

All Dynamic DNS provider support a set of client programs, which can determine the current assigned WAN IP address of a LANCOM via different methods , and transfer this address - in case of a change - to their respective Dynamic DNS server .



The current WAN IP address of a LANCOM can be picked under the following address:

`http://<address of LANCOM>/config/1/6/8/3/`

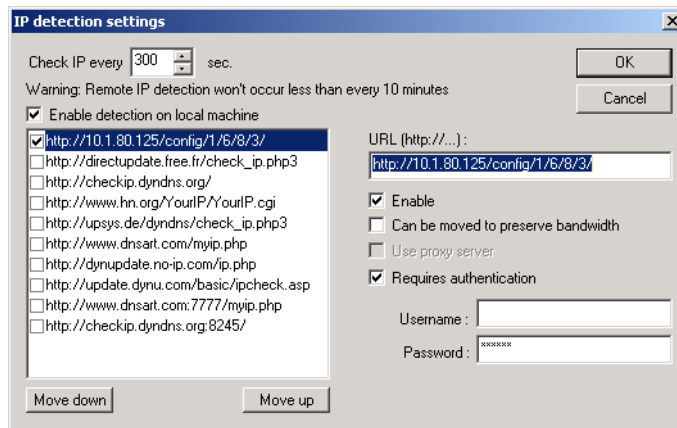

Alternatively the LANCOM can directly transmit the present WAN IP to the DynDNS provider.





The required settings can be changed comfortably with the Setup Wizard:

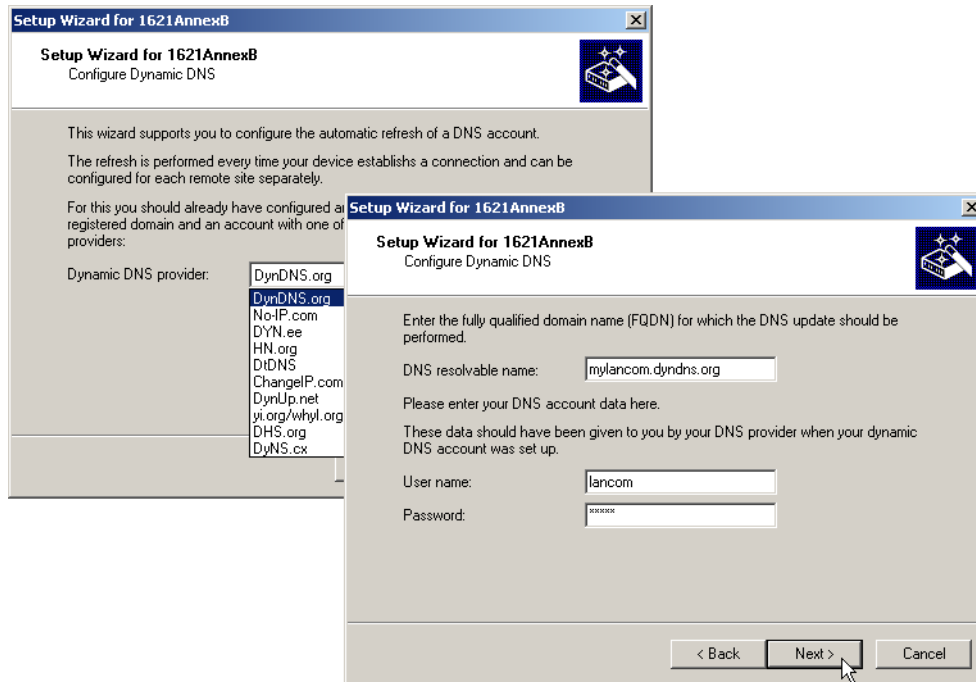

### 18.3.6 Addition(s) to LCOS 8.82

#### DNS forwarding configurable per ARF context

As of LCOS version 8.82 multiple independent forwarding definitions (especially general wildcard definitions with "\*\*") are possible for DNS forwarding by identifying them with unique routing tags. Depending on the routing context of the requesting client, the router considers only the forwarding entries that are identified accordingly and the general entries marked with "0".

#### Advanced Routing and Forwarding (ARF)

##### Routing tags for DNS forwarding

For DNS forwarding, multiple independent forwarding definitions (especially general wildcard definitions with "\*\*") are possible for DNS forwarding by identifying them with unique routing tags. Depending on the routing context of the

requesting client, the router considers only the forwarding entries that are identified accordingly and the general entries marked with "0".

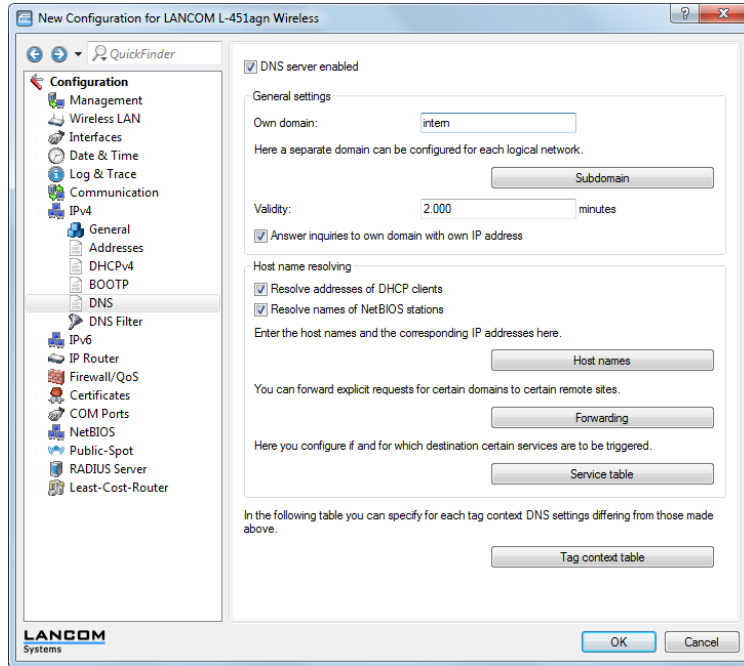

**Host names**

The item **Configuration > IPv4 > DNS > Host names** is used to define the tag context and IP number used by the device to resolve the station names.

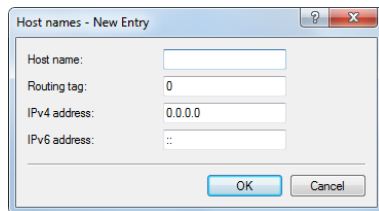

**DNS forwarding**

The item **Configuration > IPv4 > DNS > Forwarding** is used to set the routing tags for the forwarding rules, so ensuring they only apply when the correct routing tags are used.

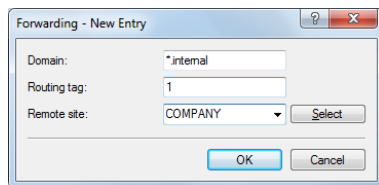

## Service table

The item **Configuration > IPv4 > DNS > Service table** is used to assign routing tags to the services, so ensuring that they are only available when the correct routing tags are used.

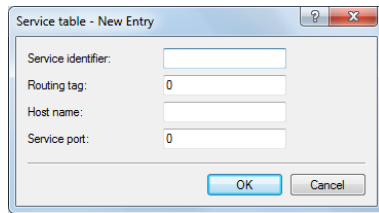

## Tag context table

It is possible to define tag contexts in LANconfig under **Configuration > IPv4 > DNS > Tag context table**, which override the global settings of the DNS server for specific interface and routing tags (routing context):

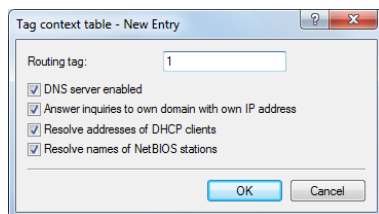

If an entry for a tag context exists, then only the DNS settings in this table apply for this context. However, if there is no entry in this table, then the global settings of the DNS server apply.

The following options are possible for each tag context:

- **Routing tag:** Unique interface or routing tag in the range of 1 to 65535, the subsequent settings will override the global settings of the DNS server.
- **DNS server enabled:** Enables the DNS server of the device.
- **Answer inquiries to own domain with own IP address:** If enabled, DNS requests relating to the router's own domain will be answered with the router's IP address.
- **Resolve addresses of DHCP clients:** Enables resolution of station names that have requested an IP address through DHCP.
- **Resolve names of NetBIOS stations:** Enables resolution of station names that are known to the NetBIOS router.

## Additions to the Setup menu

### Routing tag

When resolving a station name, the device uses the routing tag to set the tag context for that station.

#### SNMP ID:

2.17.5.4

#### Telnet path:

Setup > DNS > DNS-List

#### Possible values:

0 to 65535

#### Default:

0

**Routing tag**

The routing tag determines which filters apply in each tag context.

**SNMP ID:**

2.17.6.6

**Telnet path:**

**Setup > DNS > Filter-List**

**Possible values:**

0 to 65535

**Default:**

0

**Routing tag**

The routing tag makes it possible to specify multiple forwarding definitions that are independent of each other (especially general wildcard definitions with "\*"). Depending on the routing context of the requesting client, the router considers only the forwarding entries that are identified accordingly and the general entries marked with "0".

**SNMP ID:**

2.17.9.3

**Telnet path:**

**Setup > DNS > DNS-Destinations**

**Possible values:**

0 to 65535

**Default:**

0

**Routing tag**

The routing tag determines whether and how the router should resolve specific service requests within the current tag context.

**SNMP ID:**

2.17.10.4

**Telnet path:**

**Setup > DNS > Service-Location-List**

**Possible values:**

0 to 65535

**Default:**

0

## 18.4 Accounting

Information on connections between clients in the local network and various remote stations is saved in the accounting table with entries for the connection time and the transferred data volume. Using accounting snapshots, accounting data can be regularly saved at specific times for later evaluation.

## 18.4.1 Configuring accounting

When configuring accounting, the general parameters must be defined:

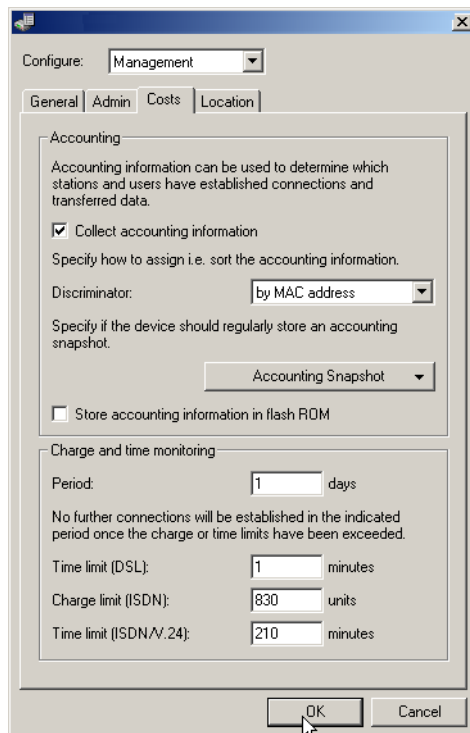

LANconfig: Management / Costs

WEBconfig: LCOS menu tree / Setup / Accounting

- Collect accounting information
  - Turn accounting on or off.
- Store accounting information in flash ROM
  - Turn accounting data in flash memory on or off. Accounting data saved to flash will not be lost in the event of a power outage.

### ■ Discriminator

Selection of the feature according to which the accounting data are to be gathered:

- MAC address: The data are collected according to the client's MAC address.
- IP address: The data are collected according to the client's IP address.



When varying IP addresses are in use, e.g. when using a DHCP server, the option 'IP address' can lead to inaccurate accounting data. In this case, it may not be possible to accurately assign the data to users. Conversely, with this setting, data can be separated from clients that are behind another router and therefore appear with the same MAC address as the router in the accounting list.

### ■ Sort according to

Select here whether the data should be sorted in the accounting table according to connection times or data volume.

## 18.4.2 Snapshot configuration

When configuring the snapshot, the interval is set in which the accounting data are temporarily saved into a snapshot:

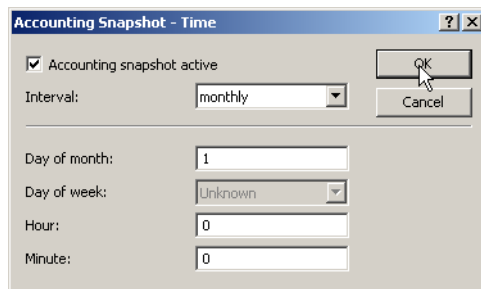

LANconfig: Management / Costs / Accounting Snapshot

WEBconfig: LCOS menu tree / Setup / Accounting / Time snapshot

 The snapshot function can only be used when the device is set with the correct system time.

- Accounting snapshot active
  - Turn intermediate storage of accounting data on or off.
- Interval
  - Daily, weekly or monthly
- Day of month
 

The day of the month on which caching will take place: Only relevant if the interval is 'monthly'.
- Day of week
 

The weekday on which caching will take place. Only relevant if the interval is 'weekly'.
- Hour
 

The hour on which caching will take place:

  - '0' to '23'
- Minute
 

The minute in which caching will take place:

  - '0' to '59'

## 18.5 Call charge management

The capability of the router to automatically establish connections to all desired remote sites and to close them again when no longer required provides users with extremely convenient access, e.g. to the Internet. However, quite substantial costs may be incurred by data transfer over paid lines if the router is not configured properly (e.g. in the filter configuration) or by excessive use of the communications opportunities (e.g. extended surfing in the Internet).

To reduce these costs, the software provides various options:

- The available online minutes can be restricted to a specific period.
- For ISDN connections, a limit on time or charges can be set for a particular period.

## 18.5.1 Connection limits for DSL and cable modem

Even though a DSL or cable modem connection behaves like a leased line, which is always online, depending on the provider connection charges can be accounted by the time.

! In this section all connections over a ethernet WAN port of the LANCOM, e. g. cable modem connection, will be referred as DSL connection.

To limit the costs, the maximal connection duration can be controlled with time, by arranging a time limit for DSL connections for a period of time. By default the DSL connections can only be used for a maximum of 600 minutes in six days.

! If the limit is reached, all DSL connections are automatically terminated. As soon as the current period has passed the time count is reset and the connection enabled. The administrator can of course reset the time count and enable the connection beforehand.

! If the connection has a charge limit and a short hold of '0' or '9999' seconds, the charge control is switched off and the connection is kept even if the limit is exceeded.

If in an exceptional case you would like to extend the online budget, e.g. to download a large file from the internet, you do not necessarily have to change the time limit. In this case you can manually reset the limit.

Click with the right mouse button on the error in LANmonitor and select in the menu the entry 'Reset Charge And Time Limit'

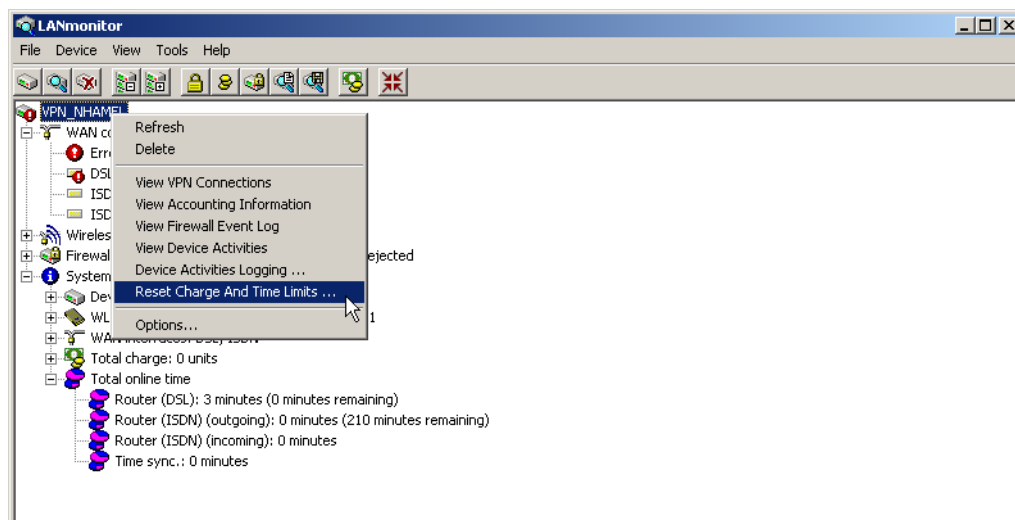

! If you cannot see the system information in LANmonitor, activate the view with **View / Show Details / System Information**.

In WEBconfig and in the console the commands to activate the additional time limit are as follows:

WEBconfig: LCOS menu tree / Setup / Charges / Activate-additional-budget

The additional time limit is activated for the current period, in the following period normal time limit is set.

## 18.5.2 Charge-based ISDN connection limits

If charge information is sent to an ISDN connection, the resulting connection charges can be limited quite easily. For example, in its default state, a maximum of 830 charge units may be used in six days. The router will not permit the establishment of any further connections once this limit has been reached.

! The best way to use the router's call charge monitoring function is if you have "call charge information enabled during the connection" to the ISDN network (i.e. AOCD). If necessary, subscribe to this facility from your

telecommunications carrier. Charge monitoring with the "Charge information **after** connection" feature is also possible in principle, but in this case continuous connections may not be detected!

- 
- ⚠ If you have enabled least-cost routing on the router modules, connections may be established to providers who do not transmit any charge information!

### 18.5.3 Time dependent ISDN connection limit

However, this mechanism of ISDN connection monitoring will not work if the ISDN connection does not provide charge information. That may be the case, for example, if the provision of charge information was not requested for the connection, or if the telecommunications provider generally does not supply this information.

To reduce the costs of ISDN connections even if no call charge information is available, maximum connection lengths based on time can be regulated. This requires setting up a time budget for a specified period. In the router's default state, for example, connections may only be established for a maximum of 210 minutes within six days.

- 
- ⚠ When the limit of a budget is reached, all open connections that were initiated by the router itself will be shut down automatically. The budgets will not be reset to permit the establishment of connections until the current period has elapsed. Needless to say, the administrator can reset the budgets at any time if required!

The charge and time monitoring of the router functions can be disabled by entering a budget of 0 units or 0 minutes.

- 
- ⚠ Only the router functions are protected by the charge and time monitoring functions! Connections via LANCAPI are not affected.

### 18.5.4 Settings in the charge module

LANconfig: Management / Costs

WEBconfig: LCOS menu tree / Setup / Charges

In the charges module, the online time can be monitored and used to control call establishment.

- Day(s)/Period

The duration of the monitoring period in days can be specified here.

- Budget units, Online minutes budget

The maximum number of ISDN units or online minutes in a monitoring period

- 
- ⚠ The current charge and connect-time information is retained when rebooting (e.g. when installing new firmware) is not lost until the unit is switched off. All the time references here are in minutes.

## 18.6 Time server for the local net

LANCOM routers can apply exact information of time either over ISDN or over public time servers on the internet (NTP-Server with 'Open Access' policy). The LANCOM can then provide the detected time for all stations in the local network.

### 18.6.1 Configuration of the time server under LANconfig

To provide the current time in the local network your LANCOM has to regularly apply the time from a time server. For this so called real time clock click in the configuration area 'Date & time' on the tab 'Synchronization'. Under 'NTP



settings' open the list of time servers by clicking on the button **Time Server ...**. With the button **Add...** you can extend the list.

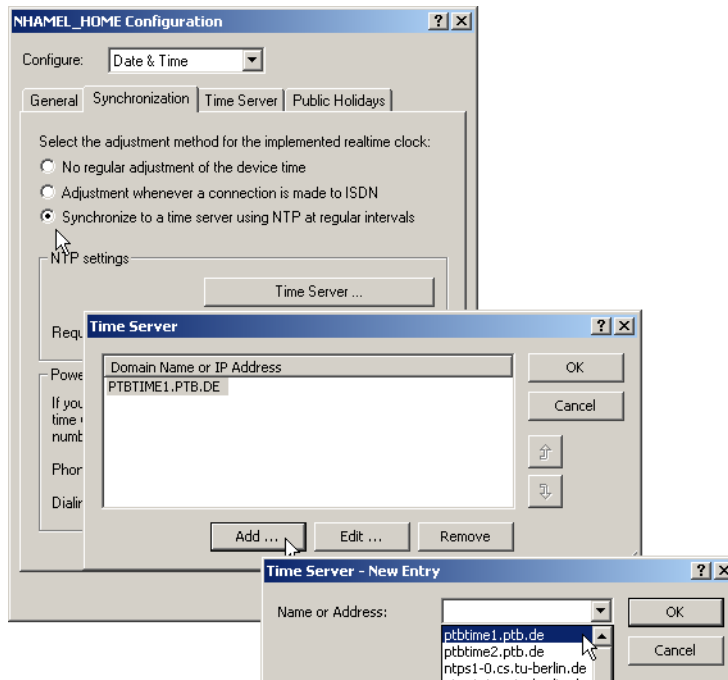

With these settings only the LANCOM applies the time from public time servers. To provide the real time for the remaining device enable the local time server under the tab 'Time Server'. Furthermore activate the broadcast mode and enter the broadcast interval.

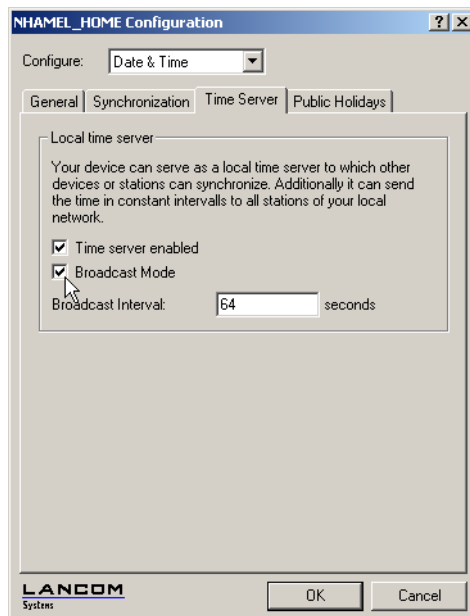

## 18.6.2 Configuration of the time server with WEBconfig or Telnet

When configuring with WEBconfig or Telnet you can find the required parameters in the following areas:

WEBconfig: LCOS menu tree / Setup / NTP

### 18.6.3 Configuring the NTP clients

The NTP clients must be configured so that they use the time information from the LANCOM. Not all operating systems provide an integrated NTP client: Windows XP does so, for other Windows operating systems a separate NTP client is required, Linux distributions have to be installed with NTP.

The settings of date and time in a XP system can be opened with a double click on the time at the bottom left, where you can select the server for synchronization.

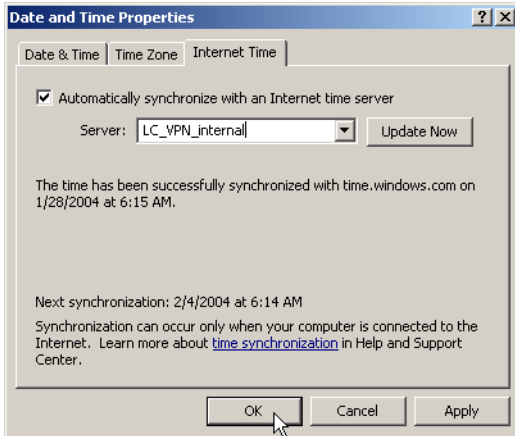

- **Configuring daylight-saving time change according to UTC**

LANCOM devices work internally with the coordinated world time (UTC). For protocol displays and time-related settings (e.g. cron jobs), the local time is taken as calculated from the defined time zone. To take local daylight-saving time into account, settings can be configured according to requirements.

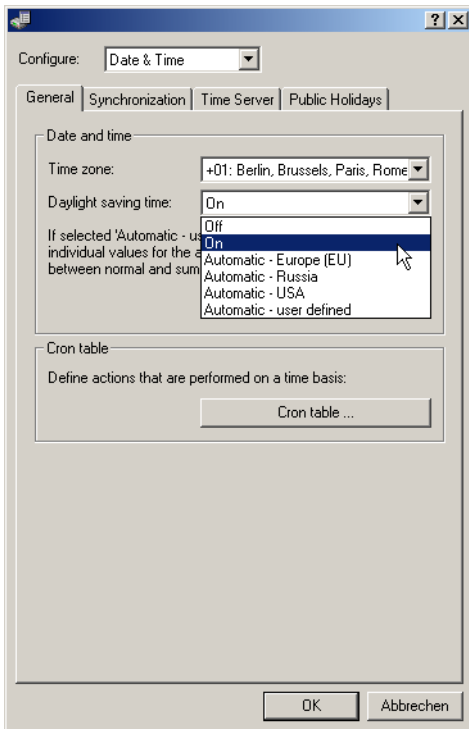

LANconfig: Date & time / General

WEBconfig: LCOS menu tree / Setup / Time / Daylight-saving time

- Daylight-saving time
  - Off: The system time will not be adjusted to daylight-saving time.
  - On: As long as this option is enabled, one hour is added statically to the current system time (comprised of UTC and time zone).
  - Automatic (EU, USA, Russia): In this setting, the daylight-saving time change is performed automatically in conformance with the time zone of the device's location.
  - Automatic (user-defined): If the device is located in an area that is not listed here, then the daylight-saving time change options can be manually defined by the user.

### User-defined daylight-saving time change

User-defined values can be set for the beginning and the end of the automatic daylight-saving time change.

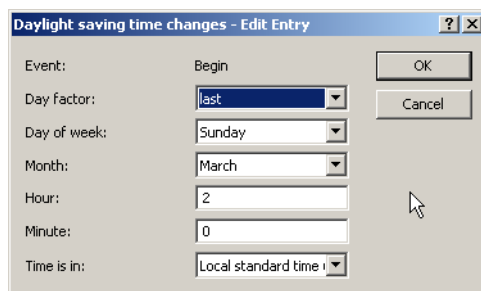

LANconfig:Date & time / General / Daylight-saving time

WEBconfig: LCOS menu tree / Setup / Time / DST clock changes

- Index
  - First, second, third, fourth, last, second to last, third to last, fourth to last: The time change will take place on this recurring day of the month.
- Day of week
  - Monday to Sunday: The day on which the change will take place.
- Month
  - January to December: The month on which the change will take place.
- Hour
  - 0 to 23: The hour in which the change will take place.
- Minute
  - 0 to 59: The minute in which the change will take place.
- Time type
  - Local standard time or UTC: Defines the time zone the data refers to.



In the last hour of daylight-saving time or the first hour that follows in standard time, it is possible for time entries to be ambiguous. If the time is acquired via ISDN or set manually during this time, then it is always assumed that the time entry is in daylight-saving time.

## 18.7 Scheduled Events

### 18.7.1 Regular Execution of Commands

This feature is intended to allow the device to execute predefined commands in a telnet-like environment, at times defined by the user. The functionality is equivalent to the UNIX cron service. Subject of execution can be any LANCOS command line command. Therefore, the full feature set of all LANCOS devices can be controlled by this facility.

Application examples:

- scheduled connection

Many leased lines disconnect automatically after 24 hours of continuous operation. This enforced disconnection can have some unwanted side-effects for example if it happens to an unsuitable time during the day, because e.g. the VPN tunnel is disconnected and the IP address of the LANCOS is changed. To control the disconnecting time a manual disconnection can be set e.g. at midnight, so it can not happen at an unsuitable time.

As a second example devices with a distributed network with only dynamic IP addresses can build up a connection at a certain time to a VPN gateway, so that data can be transferred safely. This way a protected access is even possible without an ISDN connection.

- time-dependant firewall or QoS rules

The firewall and QoS rules are at first temporally constant. But it can be useful to make variable settings for different daytimes or weekdays. At e. g. off-hours or weekends different priorities for guaranteed bandwidths can be set than at business hours.

- regular firmware or configuration updates

Time-controlled rules do not only provide the settings of particular values, it is even possible to switch to a whole different configuration. This possibility allows you to pool a whole string of settings and change them all at once with one command. Therefore changing the configuration of the device with completely different values at the weekend and switching back on monday mornings can be done with just one command.

Additionally the regular update of the newest firmware from one single source is adjustable.

- Email messages

With the time-controlled rules you have the option that the LANCOS informs the administrator by email not only about specific firewall events, but even to set times. The email can e.g. inform about building up an internet connection successfully after an enforced disconnection or after booting the device because of a restart.

- time-dependant interfaces

The time dependant use of interfaces for a set duration is also provided by the time-controlled rules. Therewith e.g. a WLAN interface can permit the wireless access to the network only at certain times.

- Deleting certain tables

It can be useful to delete the content of some tables in LCOS regularly. If your internet access for example has a monthly limited transfer volume, you can delete your accounting table monthly to have a survey of the present transferred data volume.

### 18.7.2 CRON jobs with time delay

CRON jobs are used to carry out recurring tasks on a LANCOS automatically at certain times. If the installation features a large number of active devices, all of which are subjected to the same CRON job at the same time (e.g. updating a configuration by script), unpleasant side effects can result if, for example, all devices try to establish a VPN connection at once. To avoid these effects, the CRON jobs can be set with a random delay time between 0 and 59 minutes.

### 18.7.3 Configuring the CRON job

The following parameters are available in the LANCOM for configuring CRON jobs:

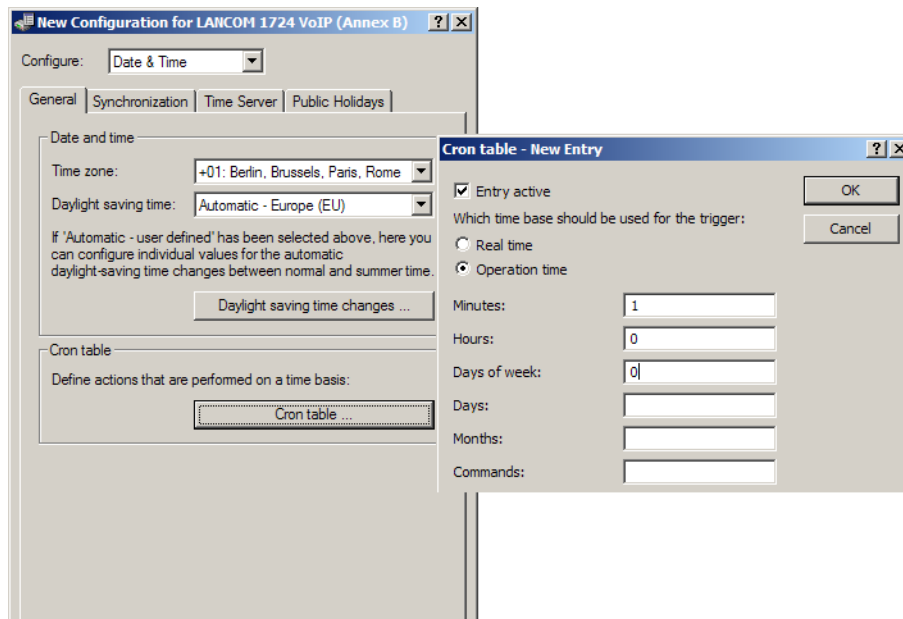

LANconfig: Date & time / General / CRON table

WEBconfig: LCOS menu tree / Setup / Config / CRON table

- Entry active

Activates or deactivates the entry.

- Default: Active

- Time base

The 'Time base' field determines whether time control is based on real time or on the device's operating time.

- Real time: These rules evaluate all time/date information.
- Operation time: These rules only evaluate the minutes and hours since the last time the device was started.
- Default: Real time

- Minutes

- Hours

- Week days

- Month days

- Months

The values 'minutes' to 'months' define the times when a command is to be executed. With no value entered, it is not included in the controlling. For each parameter, a comma-separated list of values can be entered, or alternatively a range of minimum and maximum values.

The syntax of the 'Week day' field corresponds with the usual CRON interpretation:

- 0: Sunday
- 1: Monday
- 2: Tuesday
- 3: Wednesday
- 4: Thursday
- 5: Friday

- 6: Saturday

- Command

The command to be executed or a comma-separated list of commands. **Any** LANCOS command-line function can be executed.

- Owner

An administrator defined in the device can be designated as owner of the CRON job. If an owner is defined, then the CRON job commands will be executed with the rights of the owner.

- Default: root

- Variation

This parameter specifies the maximum delay in minutes for the start of the CRON job after the set start time. The actual delay time is determined randomly and lies between 0 and the time entered here.

- Default: 0
- Values: 0 to 65535 seconds.
- Particular values: With the variation set to zero the CRON job will be executed at the set time.

 Real-time based rules can only be executed if the device has a time from a relevant source, e.g. via NTP.

Examples:

time base	min.	hours	w.-days	m.-days	months	command
real time	0	4	0-6	1-31	1-12	do /oth/man/disconnect internet
real time	59	3	0-6	1-31	1-12	mailto:admin@lancom.de Subject: disconnected body=Manual disconnection of the internet connection
real time	0	0		1		do /setup/accounting/delete
real time	0	18	1,2,3,4,5			do /oth/man/connect HEADQUARTER

- The first entry cuts the connection to the internet provider every morning at 4 am (forced disconnection).
- The second entry sends an information mail every morning at 3:59 am (directly before the forced disconnection) to the admin.
- The third entry deletes on the first of every month the accounting table.
- The fourth entry builds up a connection to the headquarter every week day at 6 pm.

 Time based rules are performed with an exactness of one minute. Please keep in mind, that the language of the used commands should be the same as the language of the console, otherwise the commands of the time automatic can not be considered. The default language is english, but can be changed.

## 18.8 PPPoE Servers

### 18.8.1 Introduction

In accordance with the widespread availability of DSL, PPPoE clients have now been widely integrated into all operating systems. These can be used to "log on to the network" as well as to manage access rights to services such as the Internet, e-mail or remote stations.

### PPPoE can only be used on a network segment.

As it is what is known as a "Layer 2" technology, PPPoE can only be used within a network segment, i.e. it cannot be used across IP subnets. The PPPoE connection cannot be established across network segment limits, such as via a router.

After a user logs on to the LAN (e.g. username: 'Purchasing', password: 'secret') using a specified PPPoE logon, further rights can be regulated via the firewall. This enters the PPPoE user name as a 'remote station' in the firewall. With a deny all rule, and a PPPoE rule in the following format, user Anyone can be permitted to use the Internet with Web and FTP:

- Source: Anyone
- Target: All stations

Services: WWW, FTP

## 18.8.2 Example application

All employees in the 'Purchasing' department must first authenticate themselves to the LANCOM using Ppoe (IP routing, PAP check) in order to access the Internet.

Constraint: The LANCOM can be accessed directly by the users in the LAN as a router, firewall and gateway, i.e. there are no other routers in between them.

The computers in Purchasing are assigned with an IP address from a certain address range (e.g. 192.168.100.200 to 192.168.100.254) from the list of addresses for dial-in connections (LANconfig/ TCP/IP / Addresses).

! The LANCOM itself is in a different IP address range!

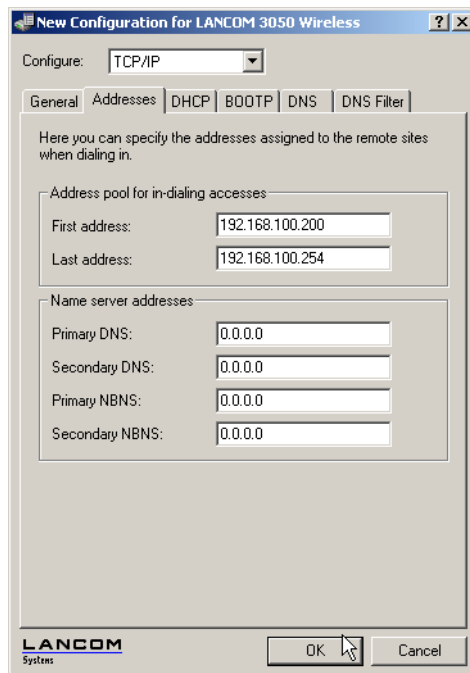

To prevent users from bypassing the authentication, a DENY ALL rule is defined in the firewall to stop local connections from being established.

The user 'Purchasing' is then entered into the PPP list (LANconfig / Communication / Protocols) without a user name but with a password which is to be used by all staff members in the department, and authentication (encrypted) is set up as CHAP. Both IP routing and NetBIOS (Windows Networking) are to be activated for this PPP user:

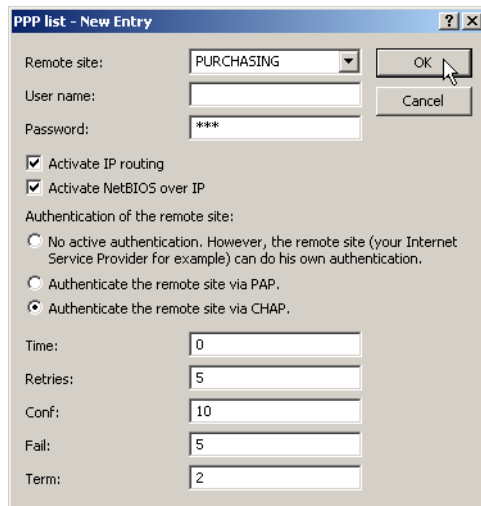

PPP list - New Entry

Remote site: PURCHASING

User name:

Password: \*\*\*

Activate IP routing

Activate NetBIOS over IP

Authentication of the remote site:

No active authentication. However, the remote site (your Internet Service Provider for example) can do his own authentication.

Authenticate the remote site via PAP.

Authenticate the remote site via CHAP.

Time: 0

Retries: 5

Conf: 10

Fail: 5

Term: 2

Along with the activation of the PPPoE server (LANconfig / Communication / General), further limitations (e.g. permissible MAC addresses) can also be defined in the PPPoE server. The example uses the existing entry 'DEFAULT' with the MAC address '00.00.00.00.00.00', thereby permitting all MAC addresses.

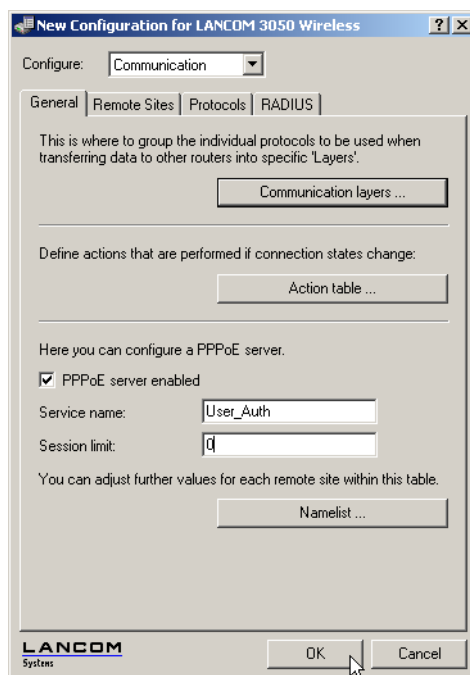

New Configuration for LANCOM 3050 Wireless

Configure: Communication

General Remote Sites Protocols RADIUS

This is where to group the individual protocols to be used when transferring data to other routers into specific 'Layers'.

Communication layers ...

Define actions that are performed if connection states change:

Action table ...

Here you can configure a PPPoE server.

PPPoE server enabled

Service name: User\_Auth

Session limit: 1

You can adjust further values for each remote site within this table.

Nameist ...

LANCOM Systems

OK Cancel



The firewall (LANconfig / Firewall/QoS / Rules) can be used to control which services are available to the employees in Purchasing (e.g. release of HTTP and EMAIL only).

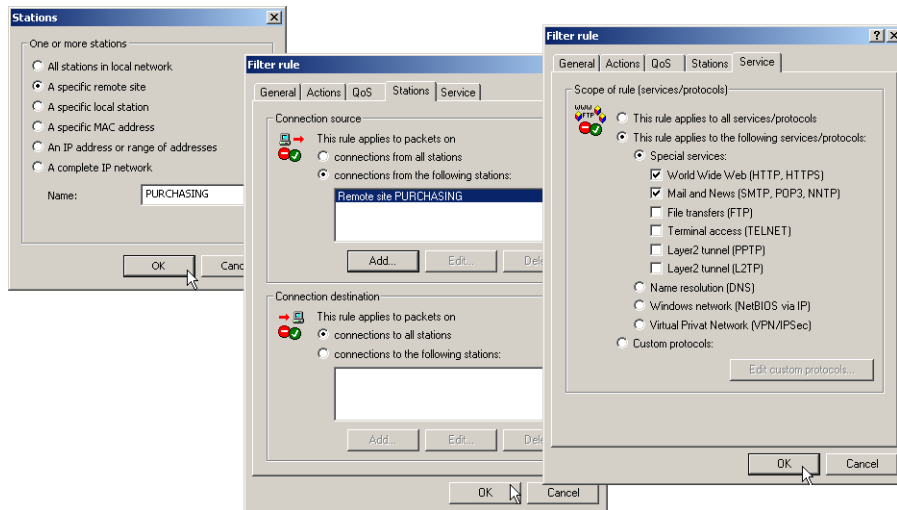

### 18.8.3 Configuration

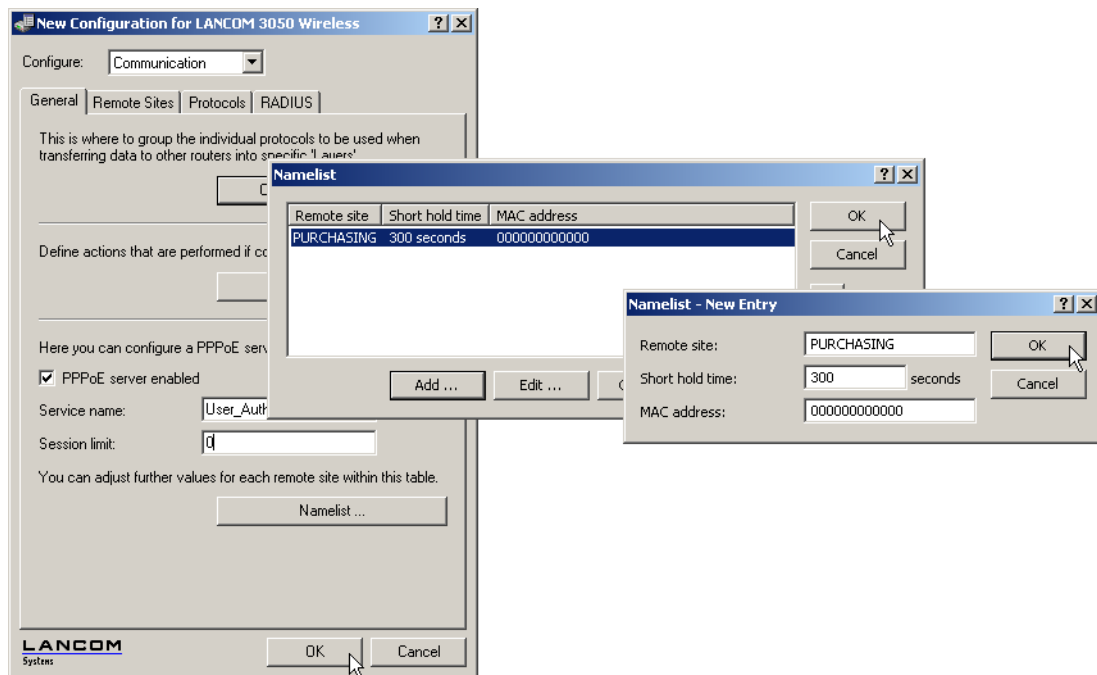

LANconfig: Communication / General

WEBconfig: LCOS menu tree / Setup / PPPoE server

- **Operating:** The 'Operating' button switches the server on or off. The default value is 'Off'.
- **Service:** The name of the service offered is entered under 'Service'. This enables a PPPoE client to select a certain PPPoE server that is entered for the client.
- **Session limit:** The 'Session limit' specifies how often a client can be logged on simultaneously with the same MAC address. Once the limit has been reached, the server no longer responds to the client queries that are received. Default value is '1', maximum value '99'. A Session limit of '0' stands for an unlimited number of sessions.

- **Name list:** Different parameters (such as shorthold time and MAC address) can be assigned to users in the name list:

ⓘ A MAC address of '000000000000' means that the user may log on with any MAC address. If a MAC address is entered, then the PPP negotiation is terminated if the user logs on from a different MAC address. The user's shorthold time is set after the logon. If no entry exists, then the time belonging to user 'DEFAULT' is used.

In addition to this table, an entry has to be made in the PPP table in which the password, the rights (IP, IPX, NetBIOS) and other PPP parameters (LCP polling) are entered. The user can therefore also be authenticated using a RADIUS server.

## 18.9 Remote bridge

The remote bridge links two remotely networks, as they would be linked physical. The two networks are completely independently from the used network protocols.

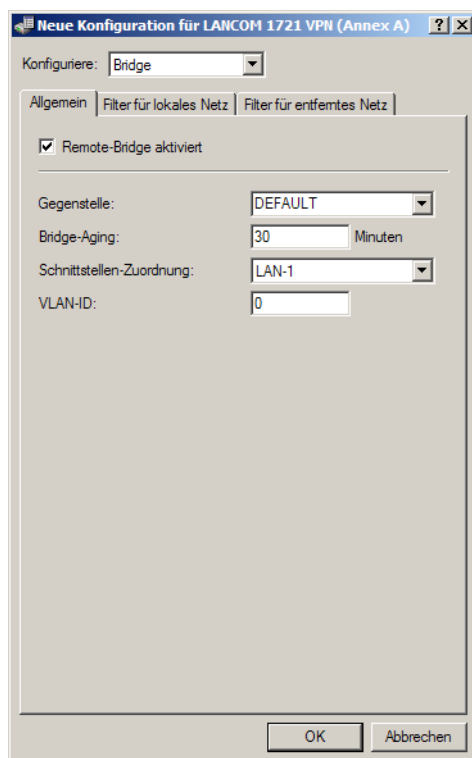

LANconfig: Bridge / General

WEBconfig: LCOS menu tree / Setup / Bridge

- Remote station  
Name of the remote station, which is linked with the remote bridg.
- Bridge-Aging  
Duration after a once learned MAC address will be deleted.
- Interface allocation  
Logical interface, which the remote bridge is assigned to.

❗ For the interface allocation are no WLANs possible, because the WAN bridge exists only in devices without WLAN. Therefore the interface allocation "any" is not possible.

- VLAN-ID

ID of the VLAN, on which the remote bridge is active.

## 18.10 RADIUS

RADIUS stands for "Remote Authentication Dial-In User Service" and is referred to as a "triple-A" protocol. The three "A"s stand for

- Authentication
- Authorization
- Accounting (billing)

This protocol allow you to grant users access to a network, to assign them certain rights and to track their actions. Where necessary, the RADIUS server can also be used in the billing of user services such as WLAN hot spots. For every action performed by the user, the RADIUS server can run an authorization procedure releasing or blocking access to network resources on a per user basis.

3 different devices are required for RADIUS to work.

- Client: This is a device (PC, notebook etc.) from which the user wishes to dial in to the network.
- Authenticator: A network component positioned between network and client and which forwards on the authorization. This task can be performed by an LANCOM Access Point for example. The authenticator is referred to as the Network Access Server (NAS).

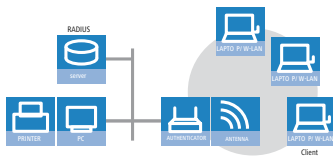

- Authentication server: RADIUS server on which user data is configured. This is usually located within the same network for which it issues access authorizations. It is accessible to the client via the authenticator. Some scenarios may also allow the use of a LANCOM access point for this task.

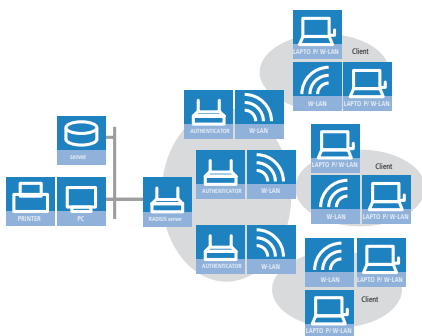

The authenticator has no initial information on the clients wanting to register. This is all stored in a database on the RADIUS server. The registration information the RADIUS server needs for the authentication process is stored in the database there and can vary from network to network. The authenticator has just the one task, that of transferring the information between the client and the RADIUS server.

Access to a RADIUS server can be configured in several ways:

## 18 More services

- Using PPP when dialing into a network
- Via WLAN
- Via a public spot for users who register using a browser (see
- Via the 802.1x protocol

### 18.10.1 How RADIUS works

The authentication process of a client using the authenticator on a RADIUS server can vary in complexity and is implementation dependent. In a simplified application, the client sends its registration data to the RADIUS server via the authenticator and receives back either an "Accept" or a "Reject".



In more complicated applications, the RADIUS server can request additional registration data using what is known as a "Challenge". The handshake sequence looks something like this:

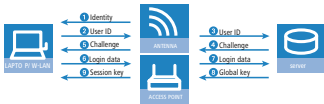

### 18.10.2 Configuration of RADIUS as authenticator or NAS

The RADIUS protocol is supported by LANCOM devices in a range of different applications. For each of these cases there is a specific set of parameters which may be configured independently of other applications. There are also general parameters which need to be configured for each of these applications. Not all devices support all applications.

#### General settings

General settings apply to all RADIUS applications. Default values have been selected such that they need not usually be changed.

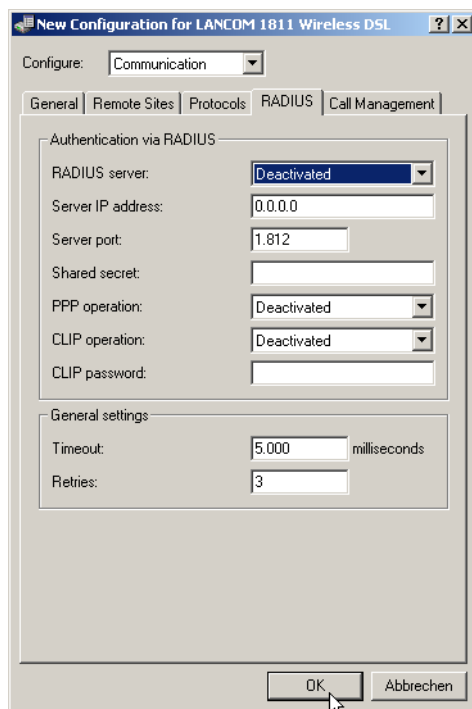

LANconfig: Communication / RADIUS

WEBconfig: LCOS menu tree / Setup / RADIUS module

- Timeout [default: 5.000]

This value specifies how many milliseconds should elapse before retrying RADIUS authentication.



With PPP authentication using RADIUS, please note that the device dialing accepts the RADIUS timeout configured here.

- Retries [default: 3]

This value specifies how many authentication attempts are made in total before a Reject is issued.

## RADIUS accounting

Accounting for a logical WLAN network can be enabled from a RADIUS server by enabling the "RADIUS Accounting" option in the logical WLAN settings for the network.

LANconfig: Interfaces / Wireless LAN / Logical WLAN settings

WEBconfig: LCOS menu tree / Setup / RADIUS module

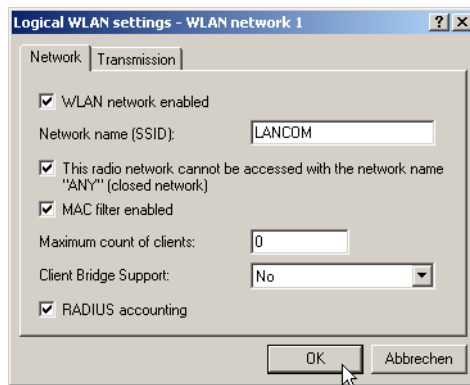

## Dial-in using PPP and RADIUS

When dialing-in using the PPP protocol (Point-to-Point protocol), RADIUS can be used to check client access authorizations. A client can dial-in to the network from anywhere. The resulting data transmission between client and authenticator is encrypted.

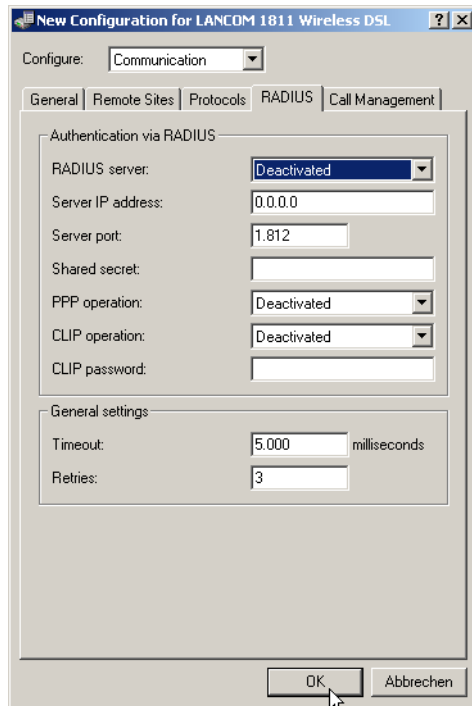

LANconfig: Communication / RADIUS

WEBconfig: LCOS menu tree / Setup / WAN / RADIUS

- Radius server [default: disabled]

When authenticating using RADIUS, the user administration and authentication tasks are passed on to a RADIUS server.

- Disabled: The functionality of RADIUS is disabled and no requests are forwarded to the RADIUS server.
- Enabled: The functionality of RADIUS is enabled and requests may be forwarded to the configured RADIUS server. Depending on the setting, other sources may be used for the authentication process (e.g. PPP list).
- Exclusive: RADIUS functionality is enabled and the authentication process is run exclusively by RADIUS.

The appropriate RADIUS server must be configured to use the functionality of RADIUS. All user data, such as user name and password, is entered on the RADIUS server.

- Server IP address

Specify here the IP address of your RADIUS server from which users are managed centrally.

- Server port [default: 1.812]

Specify here the port used for communication to your RADIUS server.

- Key (shared secret)

Specify here the key to be used for coding data. The key must also be configured on the RADIUS server.

- PPP mode [default: disabled]

A RADIUS server may be used for the authentication process when dialing-in using PPP.

- Disabled: PPP clients are not authenticated using RADIUS. They are checked **exclusively** using the PPP list.

- Enabled: RADIUS authentication for PPP clients is enabled. User data supplied by clients is **first** checked using the PPP list. If no matching entry is found in the PPP list, the client is checked by the RADIUS server. Authentication is successful if the PPP list check **or** RADIUS server check returns as positive.
- Exclusive: RADIUS authentication for PPP clients is enabled. User data supplied by clients is checked **exclusively** by the RADIUS server. In this mode, it is just the advanced settings of the PPP list for the user which are interpreted (e.g. check for PAP/CHAP – or the allowed protocols IP, IPX and/or NetBIOS).

- CLIP mode [default: disabled]

A RADIUS server may be used for control of a return call when dialing-in using PPP.

- Disabled: The return call function is not controlled by RADIUS. **Only** those entries in the name list are used.
- Enabled: The RADIUS function for the return call is enabled. Telephone numbers reported by clients are **first** checked using the name list. If no matching entry is found in the name list, the telephone number is checked by the RADIUS server. If the name list check **or** RADIUS server check returns as positive, a return call can be established.



If the telephone number communicated is in the name list, but no return call is active there, RADIUS ceases checking.

- Exclusive: The RADIUS function for the return call is enabled. User data reported by clients is checked **exclusively** by the RADIUS server.

In order to use the return call control from RADIUS, a user must be set up on the RADIUS server for each telephone number to be authenticated. The user name corresponds to the telephone number and the user password is the CLIP password specified here.

- CLIP password

Password for return call control.



The generic values for retry and timeout must also be configured. They are under PPP on the same page as PPP parameters.

## Dial-in using WLAN and RADIUS

When using a RADIUS server for the authentication of WLAN clients, the RADIUS server uses the MAC address to check client authorizations.

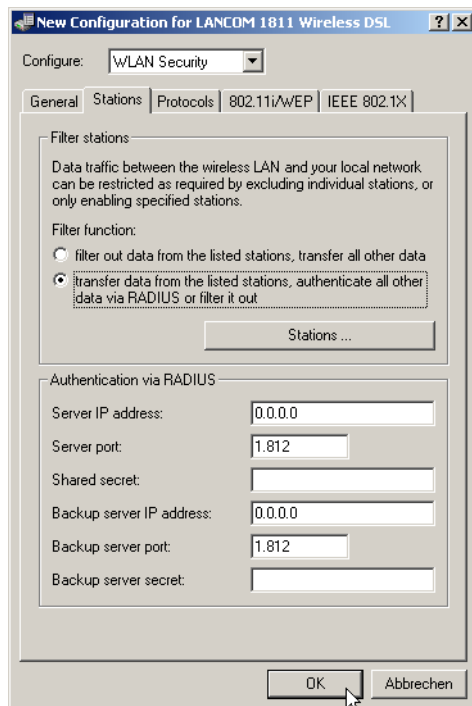

LANconfig: WLAN Security / Stations

WEBconfig: LCOS menu tree / Setup / WLAN / RADIUS access check

! To use the RADIUS functionality for WLAN clients, the option "Transfer data from the listed stations, authenticate all others via RADIUS or filter them out" must be selected for the "Filter stations" parameter.

- Server IP address  
Specify here the IP address of your RADIUS server from which users are managed centrally.
- Server port [default: 1.812]  
Specify here the port used for communication to your RADIUS server.
- Key (shared secret)  
Specify here the key to be used for coding data. The key must also be configured on the RADIUS server.
- Backup server IP address [default: 1.812]  
Specify here the IP address of your backup RADIUS server from which users are managed centrally.
- Backup server port  
Specify here the port used for communication to your backup RADIUS server.
- Backup key  
Specify here the key to be used for coding data. The key must also be configured on the backup RADIUS server.

! The generic values for retry and timeout must also be configured.



## Dial-in using a public spot and RADIUS

When configuring a public spot (enable using software option for the LANCOM access points), user registration data can be forwarded to one or more RADIUS servers. These are configured in the provider list. The registration data individual RADIUS servers require from the clients is not important to the LANCOM access point since this data is passed on transparently to the RADIUS server.

LANconfig: Public Spot / Public Spot Users/ Provider list

WEBconfig: LCOS menu tree / Setup / WLAN / RADIUS accounting

- Provider

Name of the provider for whom the RADIUS server is defined.

- Auth. server IP address

The IP address of the RADIUS server for this provider.

- Auth. server port

The port over which the LANCOM access point can communicate with the RADIUS server for this provider.

- Auth. server secret

Key (shared secret) for access to the RADIUS server of the provider. The key must also be configured on the appropriate RADIUS server.

- Acc. Server IP address

IP address of the Accounting server for accesses to the public spot.

- Acc. server port

The port over which the LANCOM access point can communicate with the accounting server.

- Acc server secret

Key (shared secret) for access to the Accounting server. The key must also be configured on the Accounting server.

- Backup provider

The name of a different provider can be selected as the backup from the current table. Using these types of entries, backup chains linking several RADIUS servers can be easily configured.

---

! The generic values for retry and timeout must also be configured.

## Dial-in using 802.1x and RADIUS

WLAN clients can use the 802.1x protocol for network registration. The LANCOM access point can use this protocol to forward the registration to the RADIUS server. The MAC address is used for user identification.

! Please refer to for further information on the 802.1 x protocol.

LANconfig: WLAN Security E IEEE 802.1X / RADIUS server

WEBconfig: LCOS menu tree / Setup / IEEE802.1x / Radius server

- Name

In this table, each RADIUS server needs a unique name. The name 'DEFAULT' is reserved for all WLAN networks that use an authentication process in line with IEEE 802.1x and that have not specified their own RADIUS server.

By using the name defined in the 'Key 1/passphrase' field, each WLAN network using authentication in line with IEEE 802.1x can be assigned its own RADIUS server.

- Server IP address

Specify here the IP address of your RADIUS server from which users are managed centrally.

- Server port

Specify here the port used for communication to your RADIUS server.

- Key (shared secret)

Specify here the key to be used for coding data. The key must also be configured on the RADIUS server.

- Backup server

Name of the backup server from the list of RADIUS servers configured so far.

! The generic values for retry and timeout must also be configured.

WLAN clients must be entered as follows on the RADIUS server:

The user name is the MAC address in the format AABBCD-DEEFF. The password for all users is identical to the key (shared secret) for the RADIUS server.

### 18.10.3 Configuring RADIUS as server

In addition to its function as RADIUS authenticator or NAS, a LANCOM access point can also operate as a RADIUS server. When in this mode, information in the device on users authorized to register is made available to other access points in Authenticator mode.

#### RADIUS server parameters

When configuring the RADIUS server, a definition is needed of which authenticator can access the RADIUS server, the password required for this access, and the open port that is to be used to communicate with the RADIUS server. The authentication port applies globally for all authenticators.

LANconfig: WLAN security / RADIUS

WEBconfig: LCOS menu tree / Setup / Radius / Server

- Authentication port [default: 0]

Specify here the port used by the authenticators to communicate with the RADIUS server in the LANCOM access point. Port '1812' is normally used.

Port '0' disables the RADIUS server.

In addition to the port, 16 authenticators that are allowed to communicate with the RADIUS server may be entered here. Entries are made in the corresponding table and with the following parameters:

- IP address  
IP address of the authenticator which may communicate with the RADIUS server in the LANCOM access point.
- Secret  
Password required by the authenticator for access to the RADIUS server in the LANCOM access point.

---

 In addition to the configuration of the RADIUS server, the client information source must also be defined .

### WLAN access list as a basis for RADIUS information

512 WLAN clients, all able to register with the LANCOM access point, may be entered in the access list. When operating in RADIUS server mode, this list can also be used to check on RADIUS clients wanting to register at other access points. In an installation having several access points, client access authorizations can be maintained centrally.

LANconfig: WLAN security / RADIUS

WEBconfig: LCOS menu tree / Setup / WLAN / RADIUS access check

- Provide server database [default: yes]  
This parameter specifies whether the WLAN access list is to be used as an information source for the RADIUS server in the LANCOM access point.  
The WLAN access list contains the user name in the form of the MAC address and the password ('WPA passphrase'). In addition to this access data, the access list provides information such as bandwidth restriction and association to a specific VLAN.
- Recheck cycle [default: 0]  
Once a WLAN client is logged on after authentication by RADIUS, it remains active until it logs off itself or is logged off by the RADIUS server. By specifying a recheck cycle [minutes], the RADIUS server can regularly check whether the WLAN clients logged in are still in the access list. If a WLAN client is removed from the access list, it remains logged in to the WLAN up to the point when the recheck cycle runs again.

---

 A recheck cycle of '0' disables regular checking. WLAN clients remain logged in until they log themselves out.

## 18.10.4 Addition(s) to LCOS 7.70

### Restarting RADIUS accounting

The accounting function in the LANCOM can be used to check the budgets of associated wireless LAN clients, among other things. Wireless Internet Service Providers (WISPs) use this option as a part of their accounting procedure. Accounting periods generally switch at the end of the month. A suitable action will cause the accounting session to be restarted at this time. Existing WLAN connections remain intact. A cron job can be used to automate a restart.

WEBconfig: LCOS menu tree / Setup / WLAN E RADIUS accounting

- Restart accounting  
Terminates all current accounting sessions and opens new accounting sessions on the RADIUS server.

## 18.11 Extensions to the RADIUS server

### 18.11.1 New authentication method

Up to version 6.30 the LCOS RADIUS server supported PAP as an authentication method only, i.e. the RADIUS client (henceforth referred to as the NAS, Network Access Server) passed on the user name and password and the server responded with an access accept or access reject. This is just one of a range of authentication methods which can be processed by RADIUS. With LCOS version the RADIUS server in the LANCOM supports additional methods of authentication:

- PAP: The NAS passes the user name and password. The RADIUS server searches its data sets for an entry matching the user name, compares the password, and responds with a RADIUS accept or RADIUS reject.
- CHAP: The NAS passes the user name, the CHAP challenge and characteristics of the password (but not the password itself). The RADIUS server searches its data sets for an entry matching the user name; it uses the associated password and the CHAP challenge from the NAS to compute the CHAP response. If this computed response and the answer sent by the client via the NAS correspond, then the RADIUS server sends a RADIUS accept; otherwise it sends a RADIUS reject.
- MS-CHAP: The NAS passes the user name, the MS-CHAP challenge and the MS-CHAP password characteristics. The method continues in the same way as CHAP, although the responses are computed with the MS-CHAP algorithm (RFC 2433).
- MS-CHAPv2: The NAS passes the user name, the MS-CHAP challenge and the MS-CHAPv2 response. The method continues in the same way as CHAP and MS-CHAP, although the responses are computed with the MS-CHAPv2 algorithm (RFC 2759). Furthermore the RADIUS server transmits an MS-CHAPv2 confirmation once the authentication was successful. This confirmation contains the server's response to the client's challenge, so enabling a mutual authentication.
- EAP: The NAS passes the user name and an EAP message. Unlike the methods outlined above, EAP is not stateless, i.e. in addition to sending an access accept or access reject, the RADIUS server issues its own challenge before authentication is completed. EAP itself is a modular authentication protocol that accommodates various methods of authentication.

### 18.11.2 EAP authentication

EAP is not a specific authentication mechanism, it is more like a framework for various authentication methods. The LCOS RADIUS server supports a range of EAP methods:

- EAP/MD5, defined in RFC 2284. EAP/MD5 is a simple challenge/response protocol. It does not cater for mutual authentication nor does it offer a dynamic key such as those required for 802.1x authentication in wireless networks (WLANs). Thus it is only used for the authentication of non-wireless clients or as a tunneled method as a part of TTLS.
- EAP/MSCHAPv2, defined in draft-kamath-pppext-eap-mschapv2-01.txt. As opposed to EAD/MD5, EAP/MSCHAPv2 does supports mutual authentication but does not support dynamic keys, making it just as prone to dictionary attacks as EAP/MD5. This method is usually used within PEAP tunnels.
- EAP/TLS, defined in RFC2716. The use of EAP/TLS requires the use of a root certificate, a device certificate and a private key in the device. EAP/TLS provides outstanding security and the dynamic keys necessary for wireless connections; its implementation is complex, however, because each individual client requires a certificate and a private key.



Please note that the TLS implementation in LCOS does not support certificate chains or certificate revocation lists (CRLs).

- EAP/TTLS, defined in draft-ietf-pppext-eap-ttls-05.txt. TTLS is based on TLS; it does not make use of client certificates and it utilizes the existing TLS tunnel to authenticate the client. The LCOS RADIUS server supports the following TTLS methods:
  - PAP
  - CHAP

- MSCHAP
- MSCHAPv2
- EAP, preferably EAP/MD5
- EAP/PEAPv0, defined in draft-kamath-pppext-peapv0-00.txt. Similar to TTLS, PEAP is based on TLS and works with an EAP negotiation inside the TLS tunnel.



Please note that although PEAP enables the use of any authentication method, the LCOS RADIUS server only supports MSCHAPv2 for tunneling.

At this time, authentication methods cannot be suppressed. The EAP supplicant and the RADIUS server negotiate the EAP method with the standard EAP mechanism. Clients requesting a non-EAP method will be rejected by the RADIUS server.

### 18.11.3 RADIUS forwarding

In the case of multi-layer EAP protocols such as TTLS or PEAP, the actual "internal" authentication can be carried out by a separate RADIUS server. Thus an existing RADIUS server can continue to be operated to provide user tables, even though it is not EAP(TLS) capable itself. In this situation the TLS/TTLS/PEAP tunnel is managed from the LCOS RADIUS server.

The configuration of multi-layer protocols of this type is an element of a general method for the forwarding of RADIUS requests, whereby a LCOS RADIUS server can also be used as a RADIUS proxy. The concept of "realms" is the basis for request forwarding and the proxy function. A realm is a character string which defines the validity of a range of user accounts. Once defined, the realm is a suffix to the user name separated by an @ character as follows:

```
user@realm
```

The realm can be seen as a pointer to the RADIUS server where the user account is managed. The realm is removed from the string prior to the search of the RADIUS server's user table. Realms allow entire networks which are mutually trustworthy to work with common RADIUS servers located in partner networks, and to authenticate users who move between these networks. The LCOS RADIUS server stores any connected RADIUS servers along with their associated realms in a forwarding table. The realm is searched for in this table in connection with the communicated user name. If no entry is found, the request is answered with an access reject. An empty realm is treated as a local request, i.e. the LCOS RADIUS server searches its own user tables and generates its response accordingly.

To support the processing of realms the LCOS RADIUS server uses two special realms:

- Default realm: This realm is used where a realm is communicated for which no specific forwarding server has been defined. Importantly, a corresponding entry for the default realm itself must be present in the forwarding table.
- Empty realm: This realm is used when **no** realm is communicated, but the user name only.

In the default state the forwarding table has no entries, i.e. the default and empty realms are empty. This means that all requests are treated as local requests and any realms which are communicated are ignored. To operate the LCOS RADIUS server purely as a forwarding server or RADIUS proxy, the default and empty realms must be set to a value that corresponds with a server defined in the forwarding table.

Please note that the forwarding of RADIUS requests does not alter the user name. No realm is added, changed or removed. The next server may not be the last one in the forwarding chain, and the realm information may be required by that server to ensure that forwarding is carried out correctly. Only the active RADIUS server which processes the request resolves the realm from the user name, and only then is a search made of the table containing the user accounts. Accordingly the LCOS RADIUS server resolves the realm from the user name for processing requests locally.

The processing of tunneled EAP requests using TTLS and PEAP makes use of a special EAP tunnel server, which is also in the form of a realm. Here you select a realm that will not conflict with other realms. If no EAP tunnel server is defined then the LCOS RADIUS server forwards the request to itself, meaning that both the internal and the external EAP authentications are handled by the LCOS RADIUS server itself.

## 18.11.4 RADIUS server parameters

For the configuration of the RADIUS server, the clients which are permitted to access the RADIUS server are defined (including password), as is the UDP port which the clients can use to communicate with the RADIUS server. The authentication port applies globally for all clients.

WEBconfig: LCOS menu tree / Setup / Radius / Server

### Global settings for the RADIUS server

- Authentication port [default: 0]

Specify here the port used by the authenticators to communicate with the RADIUS server in the LANCOM access point. Port '1812' is normally used.

- Port '0' disables the RADIUS server.

- Default realm

This realm is used if the user name is supplied with an **unknown** realm that is not in the list of forwarding servers.

- Empty realm

This realm is used when the user name supplied does **not contain** a realm.

### RADIUS clients

The client table can contain up to 16 clients that can communicate with the RADIUS server.

- IP address

Enter the IP address of the client that may communicate with the RADIUS server in the LANCOM access point.

- Secret

Password required by the client for access to the RADIUS server in the LANCOM access point.



In addition to the configuration of the RADIUS server, the user information source must also be defined .

### RADIUS user

Up to 64 users can be entered into the user table, and these can be authenticated by the RADIUS server without reference to other databases. This user table is used for local requests to the RADIUS server, i.e. for requests with user name but no realm.

- User name

User name.

- Password

User password.

- Limit auth. methods

This option allows you to place limitations on the authentication methods permitted for the user.

- Values: PAP, CHAP, MSCHAP, MSCHAPv2, EAP, All
- Default: All

### Forwarding server

The table of forwarding servers contains up to 16 realms with the associated forwarding destinations.

- Realm

Character string identifying the forwarding destination.

- IP address

IP address of the RADIUS server to which the request is to be forwarded.

- Port

Open port for communications with the forwarding server.

- Secret

Password required for accessing the forwarding server.

- Backup

Alternative forwarding server in case the first forwarding server is not available.

### EAP options for the RADIUS server

- EAP tunnel server

This realm refers to the entry in the table of the forwarding server that is to be used for tunneled TTLS or PEAP requests.

- TLS check username

TLS authenticates the client via certificate only. If this option is activated, the RADIUS server additionally checks if the username in the certificate is contained in the RADIUS user table.

## 18.11.5 Addition(s) to LCOS 7.80

### XAUTH with external RADIUS servers

As of LCOS version 7.60, LANCOM devices can identify and authenticate remote stations with the Extended Authentication Protocol (XAUTH). Authentication referred to the user data in the PPP list.

As of LCOS version 7.80, XAUTH authentication can also be handled by an (external) RADIUS server. For example, this allows reference to existing RAS user data on the RADIUS server, assuming that RADIUS-authenticated dial-in via PPP has been set up for VPN with XAUTH.

To supplement VPN dial-in with XAUTH for authentication, please proceed as follows:

1. Set up a VPN dial-in account, for example with the LANconfig Setup Wizard.

2. Activate XAUTH in the VPN client at the station which is to dial in. The user name and password are the same as those stored on the RADIUS server.

**Assistant for New Profile**

**VPN Gateway Parameters**  
To which VPN gateway should the connection be established?

Enter the DNS name (i.e. vpnserver.domain.com) or the official IP address (i.e. 212.10.17.29) of the VPN gateway you want to connect to.  
Using Extended Authentication (XAUTH) you can enter the user ID and password for the authentication. If no authentication data are entered they will be requested when establishing the connection.

 **Gateway (Tunnel Endpoint):**  
vpnserver.company.com

**Extended Authentication (XAUTH)**

 **User ID:**  
user

**Password:** [masked]      **Password (confirm):** [masked]

< Back      Next >      Cancel



1. Activate the authentication of dial-in remote stations via the XAUTH protocol on an external RADIUS server. In LANconfig, access the configuration area **Communication** and the **RADIUS** tab to activate the "Exclusive" operating mode for the RADIUS server. With this setting, all incoming XAUTH requests are authenticated by the RADIUS server.

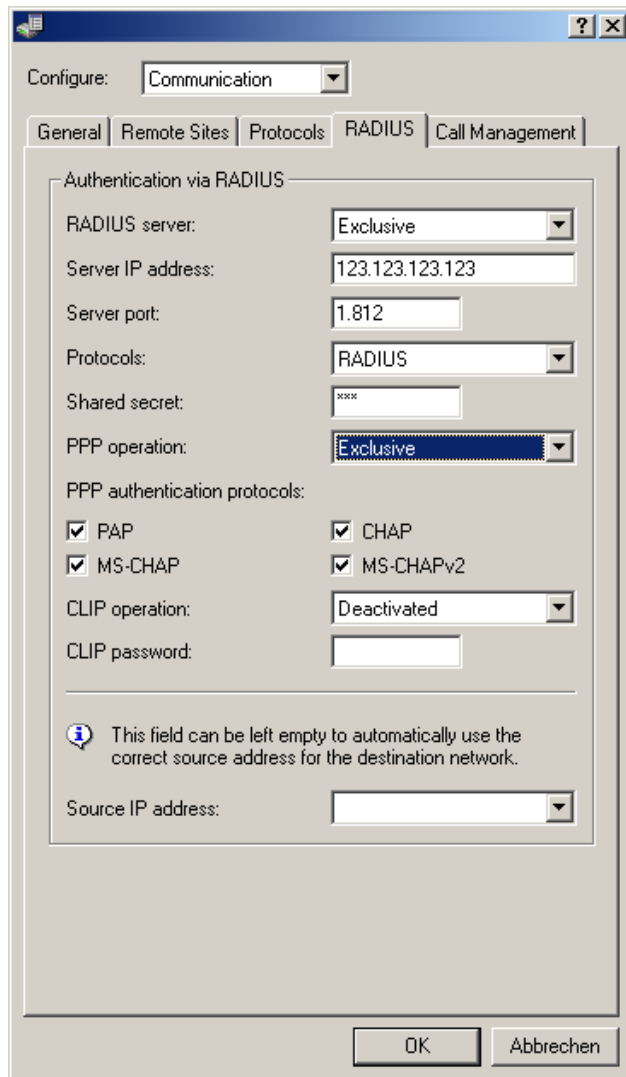

1. You should also specify the IP address, the port, and the key for the external RADIUS server.
2. Also set PPP operation to "Exclusive" so that incoming XAUTH requests are authenticated by the RADIUS server only.

### 18.11.6 Addition(s) to LCOS 8.80

#### LCS WPA passphrase in the RADIUS server's user table

As of LCOS version 8.80, of the RADIUS server's user table additionally contains the associated WPA passphrase of the registered user. This enables a device which is connected to the LAN to operate as a central RADIUS server and use the benefits of LEPS (LANCOM Enhanced Passphrase Security).

#### Configuration

The configuration of LEPS merely involves the assignment of an individual passphrase to the MAC address of each client that is approved for the WLAN. To this end, the MAC filter is set to positive, i. e. the data from clients entered here will be transmitted.

---

 The passphrases should consist of a random string at least 32 characters long.

The client-specific passphrase is stored in the RADIUS server's user table. This enables a device which is connected to the LAN to operate as a central RADIUS server and use the benefits of LEPS.

### Additions to the menu system

#### WPA passphrase

Here you can specify the WPA passphrase with which users can login to the WLAN.

---

 The RADIUS server stores this passphrase in the user table. This enables a device which is connected to the LAN to operate as a central RADIUS server and use the benefits of LEPS (LANCOM Enhanced Passphrase Security).

#### SNMP ID:

2.25.10.18

#### Telnet path:

**Setup > RADIUS > Server > Users**

#### Possible values:

8 to 63 characters

from ABCDEFGHIJKLMNOPQRSTUVWXYZ@[]~!\$%&'()+-./,:;<=>?[\]^\_0123456789

#### Default:

Blank

## 18.11.7 Addition(s) to LCOS 8.82

### Input length for RADIUS forwarding destinations

As of LCOS version 8.82, realms can be up to 64 characters long, in order to use roaming providers with long realms.

#### Additions to the Setup menu

##### Realm

String with which the RADIUS server identifies the forwarding destination.

#### SNMP ID:

2.25.10.3.1

#### Telnet path:

**Setup > RADIUS > Server > Forward-Server**

#### Possible values:

Max. 64 characters

#### Default:

Blank

##### Backup

Alternative routing server that the RADIUS server forwards requests to when the first routing server is not reachable.

**SNMP ID:**

2.25.10.3.5

**Telnet path:****Setup > RADIUS > Server > Forward-Server****Possible values:**

Max. 64 characters

**Default:**

Blank

**Default realm**

This realm is used if the supplied username uses an unknown realm that is not in the list of forwarding servers.

**SNMP ID:**

2.25.10.5

**Telnet path:****Setup > RADIUS > Server****Possible values:**

Max. 64 characters

**Default:**

Blank

**Empty realm**

This realm is used when the specified username does not contain a realm.

**SNMP ID:**

2.25.10.6

**Telnet path:****Setup > RADIUS > Server****Possible values:**

Max. 64 characters

**Default:**

Blank

**Bandwidth allocation by RADIUS**

As of LCOS version 8.82, the LANCOM RADIUS server can assign each registered client a bandwidth limitation regardless of the interface used. Up until now, that was only possible for Public Spot scenarios if the Public Spot gateway and the associated WLAN interface were both enabled on the same device.

## Extensions to the RADIUS server

### RADIUS user

You can enter up to 64 users in the user database that the RADIUS server can authenticate without needing other databases. This user table uses the RADIUS server for local requests, also for requests with usernames without a realm.

- **Name:** Enter the name of the user
- **Please note that the username is case-sensitive:** When enabled, the RADIUS server distinguishes between uppercase and lowercase. "User12345" and "user12345" are therefore two different users.
- **Password:** User password.
- **VLAN ID:** ID of the logical subnet
- **Comment:** Additional information about the user
- **Service type:** The service type is a special attribute of the RADIUS protocol, which the NAS (Network Access Server) transmits with the authentication request. The request will only receive a positive response if the requested service type fits the service type of the user account. Possible values include:
  - `Any`: The service type can be any type.
  - `Framed`: For checking WLAN MAC addresses via RADIUS or IEEE 802.1x.
  - `Login`: For Public-Spot logins.
  - `Authentication only`: For RADIUS authentication of dialup peers via PPP.



Please note that, depending on the device, the number of entries can be limited with the service type `Any` or `Login`. If your device, for example, is able to manage a total of 64 Public Spot users, the LANconfig rejects them after 64. User account with the service type `Any/Login` requires the creation of additional user accounts with these service types.

- **Protocol restriction:** This option limits the selection of authentication methods allowed for the user. Possible values include:
  - PAP
  - CHAP
  - MSCHAP
  - MSCHAPv2
  - EAP
- **Passphrase:** Associated WPA passphrase of the registered user
- **TX bandwidth limit:** Bandwidth limitation for sending data
- **RX bandwidth limit:** Bandwidth limitation for receiving data

 The bandwidth limitation for sending and receiving applies regardless of the interface used (LAN and WLAN).

- **Calling station:** This mask limits the validity of the entry to certain IDs transmitted by the calling station (WLAN client). When authenticating via 802.1x the calling station's MAC address is transmitted in ASCII format (capital letters only) with a hyphen separating pairs of characters (for example, "00-10-A4-23-19-C0").
- **Called station:** This mask limits the validity of the entry to specified IDs as transmitted by the called station (BSSID and SSID of the access point). When authenticating via 802.1x the called station's MAC address (BSSID) is transmitted in ASCII format (capital letters only) with a hyphen separating pairs of characters. The SSID is appended using a colon as a separator (e.g., "00-10-A4-23-19-C0:AP1").
- **Expiry type:** This option specifies the type of the validity period of the user account. Possible values include:
  - Relative & absolute:
  - Relative
  - Absolute
  - Never
- **Relative expiry:** Validity period in seconds from the initial successful login
- **Absolute expiry:** Validity period in hours, minutes and seconds from a certain date
- **Multiple login:** Activates the option for the client to register more than once
- **Maximum number:** Maximum number of concurrent logins by the client
- **Time budget:** Specifies the time in seconds available to the client.
- **Volume budget:** Specifies the data volume available to the client.

#### Additions to the Status menu

##### Station table

This table contains the bandwidth allocations for the clients registered on the RADIUS server, regardless of the interface that the clients are connected to.

##### SNMP ID:

1.5.90

##### Telnet path:

Status > LAN

##### Interface

Interface to which the client is connected.

##### MAC address

MAC address of the client

##### Tx limit

Bandwidth limitation for the reception of data.

##### Rx limit

Bandwidth limitation for sending data.

##### VLAN ID

VLAN ID of the network over which the client communicates.

## 18.12 RADSEC

RADIUS has become established as the standard for server-based authentication, authorization and billing. RADIUS is now being used for applications outside of its original design purpose, for example in combination with EAP/802.1x, and a number of deficits have become apparent:

- RADIUS operates via UDP and thus offers no native procedure for packet-loss detection. Although this is no problem in a LAN environment, it is becoming increasingly important over WAN connections or on the Internet.
- RADIUS is equipped only with simple procedures for authentication by means of a "shared secret" and a low level of confidentiality.

RADSEC is an alternative protocol that transmits RADIUS packets through a TLS-encrypted tunnel. TLS is based on TCP, thus providing a proven mechanism for monitoring packet loss. Furthermore, TLS is highly secure and it features a method of mutual authentication by means of X.509 certificates.

### 18.12.1 Configuring RADSEC for the client

#### LANCOM as a RADIUS client

To function as a RADIUS client, a LANCOM is set up to use RADIUS via UDP or RADSEC via TCP with TLS. Additionally the port to be used has to be set. 1812 for authentication with RADIUS, 1813 for billing with RADIUS and 2083 for RADSEC.

These settings are made at all locations where a LANCOM is configured as a RADIUS client.

WEBconfig: **Setup / WAN / RADIUS**

WEBconfig: **Setup / WLAN / RADIUS-access-check**

WEBconfig: **Setup / WLAN / RADIUS-accounting**

WEBconfig: **Setup / Public-spot-module / Provider-table**

WEBconfig: **Setup / IEEE802.1x / RADIUS-server**

#### LANCOM as a RADIUS server

If a LANCOM operates as a RADIUS server, the RADSEC port for receiving logins can be set up. In addition to that, the protocol to be used (RADIUS, RADSEC or all) can be set for each of the RADIUS clients in the client list. This allows, for example, RADIUS to be used for LAN-based clients and the more robust RADSEC via TCP to be used for registrations arriving over the Internet.

### 18.12.2 Certificates for RADSEC

Separate X.509 certificates are required for TLS encryption of the RADSEC connection. The individual certificates (root certificate, devices certificate and private key) can be uploaded to the device individually or as a PKCS#12 container.

WEBconfig: **Upload certificate or file**

## Upload Certificate or File

Select which file you want to upload, and its name/location, then click on 'Start Upload':

File Type:

File Name/Location:

Passphrase (if required):

Caution: Files are not being performed by the individual user. These checks are performed by the individual user. These error messages can be seen in the VPN logs.

05/07/2008 22:59

[Previous Page](#)

SSL - Certificate (\*.pem, \*.crt, \*.cer [BASE64])  
 SSL - Certificate (\*.pem, \*.crt, \*.cer [BASE64])  
 SSL - Private Key (\*.key [BASE64 unencrypted])  
 SSH - RSA Key (\*.key [BASE64 unencrypted])  
 SSH - DSA Key (\*.key [BASE64 unencrypted])  
 SSH - accepted public keys  
 VPN - Root CA Certificate (\*.pem, \*.crt, \*.cer [BASE64])  
 VPN - Device Certificate (\*.pem, \*.crt, \*.cer [BASE64])  
 VPN - Device Private Key (\*.key [BASE64 unencrypted])  
 VPN - Container as PKCS#12-File (\*.pfx, \*.p12 [requires passphrase])  
 EAP/TLS - Root CA Certificate (\*.pem, \*.crt, \*.cer [BASE64])  
 EAP/TLS - Device Certificate (\*.pem, \*.crt, \*.cer [BASE64])  
 EAP/TLS - Device Private Key (\*.key [BASE64 unencrypted])  
 EAP/TLS - Container as PKCS#12-File (\*.pfx, \*.p12 [requires passphrase])  
 RADSEC - Root CA Certificate (\*.pem, \*.crt, \*.cer [BASE64])  
 RADSEC - Device Certificate (\*.pem, \*.crt, \*.cer [BASE64])  
 RADSEC - Device Private Key (\*.key [BASE64 unencrypted])  
 RADSEC - Container as PKCS#12-File (\*.pfx, \*.p12 [requires passphrase])  
 Public Spot - Welcome Page (\*.html, \*.htm)

## 18.13 Operating printers at the USB connector of the LANCOM

With the USB port of various LANCOM models, printers can be connected up and made available to the entire network. The LANCOM provides a print server to manage the printing jobs from the network. Supported protocols are RawIP and LPR/LPD.

 Parallel print jobs arriving from different stations are saved on the respective computer. The print server in the LANCOM processes the waiting jobs one after the other.

### 18.13.1 Configuring the printer server in the LANCOM

When configuring the USB port for the connection of a printer, the first thing is to define the ports which will receive the print jobs as transported by the various protocols.

#### Printer table

The printer table contains the settings for the connected printer.

WEBconfig: Expert-Configuration / Setup / Printer / Printer

Normally there will be no need to adjust the printer settings. With the default settings, the print server works with RawIP and LPR/LPD and reacts to the standard ports as suggested by Windows when the printer connection is being configured. If printer operation does not work with these settings, the printing parameters can be adjusted.

- **Printer** [Default: \*]

Printer name.

- **RawIP-Port** [Default: 9100]

This port can be used to accept print jobs over RawIP.

 RawIP is used by Windows as standard and is recommended for operating printers at a USB port.

- **LDP-Port** [Default: 515]

This port can be used to accept print jobs over LDP.

 The protocol and port options entered here must agree with the settings for the printer connection in the corresponding computer's operating system.

- **Active** [Default: No]
  - Yes: The print server is active.
  - No: The print server is not active.
- **Bidirectional** [Default: No]
  - Yes: The LANCOM transmits the printer's status information at regular intervals to the connected computers.
  - No: The LANCOM does not transmit and status information.

**Access list:**

Up to 16 networks that have access to the configured printer can be entered into the access list.

LANconfig: Printer / General / Access list

WEBconfig: Expert-Configuration / Setup / Printer / Access-List

- **IP address**

IP address of the network with clients requiring access to the printer.
- **Net mask**

Netmask of the permitted networks.

 If the access list is empty, any computer with any IP address can use the printer at the LANCOM's USB port.

 For reasons of security, access from the WAN to the printer at the USB port of the LANCOM is not permitted.

### 18.13.2 Printer configuration at the computer

To use the printer at the USB port over the network, the printer drivers on the computers have to be connected with a corresponding printer connection. The following is a description of the setup under Windows XP; the configuration under Windows 2000 is similar. Controlling printers via TCP/IP ports with older version of Windows is rather unsatisfactory.

1. In the Control Panel, open the dialog for the configuration of a new printer and start the Wizard to add a new printer.
2. Select the option for a local printer and deactivate Plug&Play.

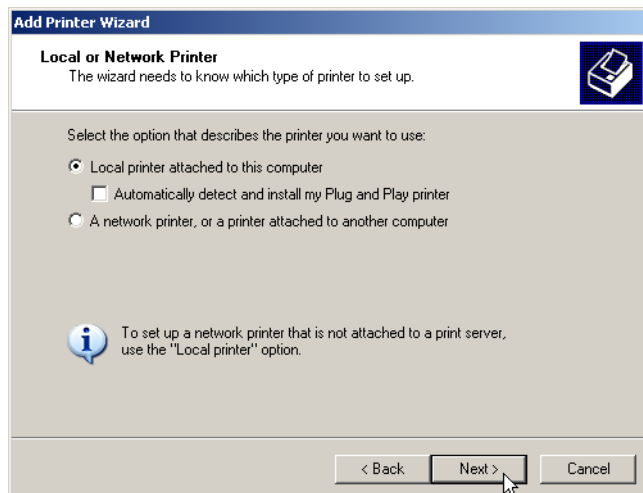



1. Select the option to add a new printer port.

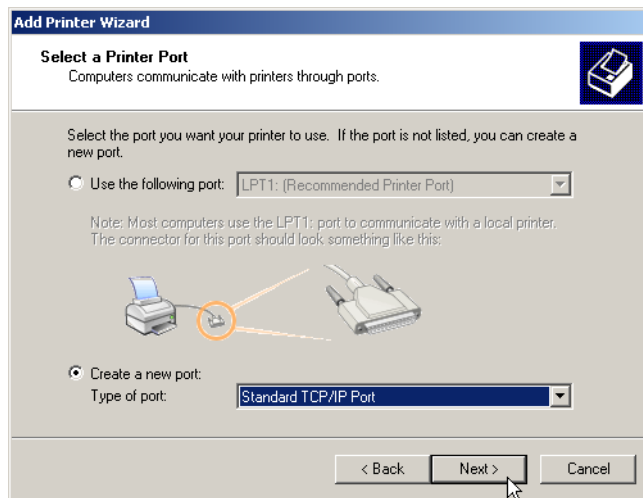

1. Enter the IP address of the LANCOM as the IP address of the printer port. The name for the printer port will automatically be filled out with 'IP\_<IP address of the LANCOM>'.

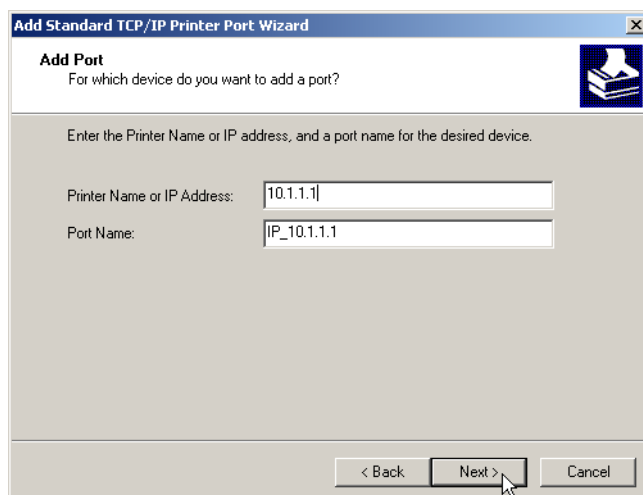

1. As the device type, select the option 'Standard' for a 'Generic Network Card'. If you wish to keep the standard settings (recommended), press on **Next** to proceed to the next dialog.

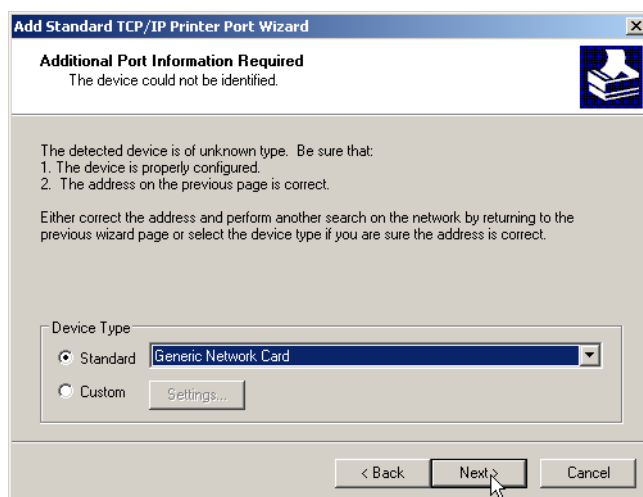

- Alternatively, you can select 'Custom' and press on the **Settings** button to open an additional dialog. In this dialog, you can select the protocol to be used for transmitting the print jobs to the printer at the USB port of the LANCOM ('Raw' for RawIP or 'LPR').. The port to be used can be entered here too (for RawIP only). For LPR, port '515' is always used as standard.

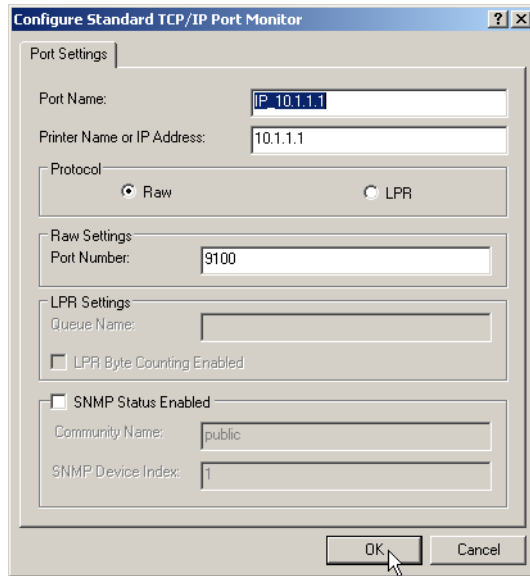

! The protocol and port options entered here must agree with the settings for the printer in the LANCOM configuration.

! The dialog for selecting the protocol and port can also be accessed via the Control Panel by opening the Printer Properties and accessing the 'Ports' tab.

- Once the settings have been made, the printer port is set up. The Wizard now goes on with the selection of the printer driver.

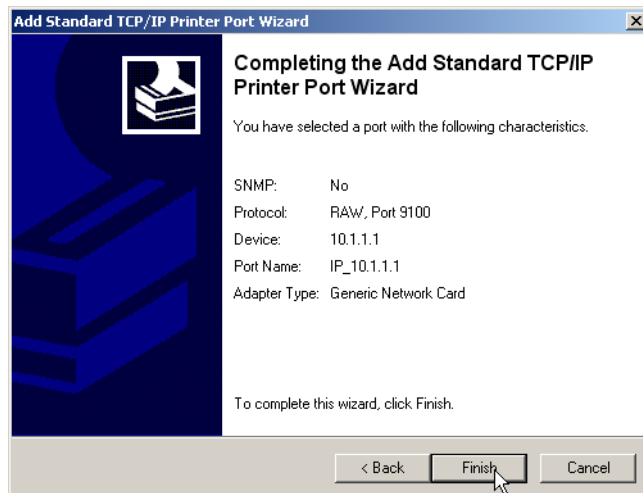

! Further information about the installation of a printer driver is available in the documentation for the printer.

## 18.14 Addition(s) to LCOS 7.70

### 18.14.1 IGMP snooping

#### Introduction

All LANCOM devices with wireless LAN interfaces feature a "LAN bridge", a software entity for transferring data between the Ethernet ports and the WLAN interface(s). In many ways the LAN bridge works like a switch. The core task of a switch, as opposed to a hub, is to forward packets precisely to the port which the relevant user is connected to. Based on the incoming data packets, the switch automatically creates a table listing the senders' MAC addresses and their ports.

If the table contains the destination address for an incoming packet, the switch forwards the packet to the corresponding port. If the destination address is not in the table, the switch forwards the packet to all ports. This means that a switch can only deliver a packet precisely if the destination address appeared earlier in a packet arriving at a certain port from the sender's address. However, broadcast or multicast packets can never be entered as a sender address into a packet, and so these packets end up being "flooded" to all ports.

This may be the correct action for broadcasts which are supposed to reach all available receivers, but this may not be the case for multicasts. Multicasts are generally aimed at a certain group of receivers within a network, but not all of them:

- For example, video streams are frequently transmitted as multicasts, but not all of the network stations are intended to receive that stream.
- Various applications in the medical field rely on multicasts to send data to certain terminal devices, but this data should not be available to all stations.

A LAN bridge in the LANCOM will have ports to which no multicast recipients are connected. This "unnecessary" transmission of multicasts to ports without any receivers is not an error, but it can compromise overall performance.

- Many stations are unable to reject the unwanted multicasts in their hardware. Instead, the packets are forwarded to higher protocol layers, which leads to an increase in CPU load.
- WLANs are particularly susceptible to bandwidth restrictions due to multicasts if none of the associated WLAN clients want to receive the multicast.

The TCP/IP protocol suite defines a protocol called IGMP that allows network stations to register their desire to receive certain IP multicasts to their router. Stations carry out a multicast registration with their router to subscribe to certain multicast groups which deliver the relevant packets. IGMP makes use of Join messages and Leave messages to register and de-register respectively.

---

 Information about which multicast groups a station can or should join are available from other protocols than IGMP.

As a layer-3 protocol, IGMP only performs multicast guiding/routing for whole IP subnets. However, network devices such as bridges, switches or WLAN access points only forward the packets on layer 2, meaning that IGMP itself does not help in any way to further guide multicast traffic through this substructure. For this reason, the bridges use the multicast registrations between stations and routers to receive additional information for targeting the distribution of multicasts. IP multicasts only need to be forwarded to an interface where a router is located that is capable of multicast routing and therefore of forwarding multicasts to other IP subnets. This method is called IGMP snooping. The bridges, which normally use the MAC on layer 2 for packet forwarding, thus additionally use the layer 3 information in the IP multicast packets.

For more detailed description of the functions of IGMP snooping in LCOS, we have to differentiate between two important terms:

- A port is "member" of a multicast group if at least one station connected to it wishes to receive the packets for a certain multicast address. Multicast registration can be dynamic via IGMP snooping or configured manually.

- A port is a "router port" if it is connected to a router that is capable of multicast routing and therefore of forwarding multicasts to other IP subnets.
- A multicast group is "unregistered" if none of the interfaces attached to the bridge is a member of this multicast group.

### IGMP snooping operation

Whenever a packet is received, the bridge initially determines whether it is a unicast, broadcast, or multicast packet. For broadcast and unicast packets, the bridge operates in the usual way, i.e. it floods to all ports or sends to a specific port based on the MAC table entry for the receiver.

Two types of IP multicast packet are differentiated (whereby packets which are truncated or contain an invalid checksum are discarded entirely):

- IGMP messages are handled in different ways depending on their content:
  - A Join message results in the incoming port becoming member of the respective multicast group. This message is forwarded to router ports only.
  - Similarly, a Leave message results in the incoming port being removed from the multicast group's member list. This message is also forwarded to router ports only.
  - An incoming IGMP query results in the port being marked as a router port. These messages are flooded to all interfaces.
  - All other messages are flooded to all interfaces—no ports experience a change of state.
  - If an IP multicast packet does not contain an IGMP message, the IP destination address is examined. Packets for the destination address "224.0.0.x" are flooded to all ports because this is a "reserved" range. For all other packets the destination address is looked up in the IGMP membership table:
    - If the address is found, the packet is forwarded according to the membership stored in the table.
    - If the address is not found, the packet may either be discarded, flooded to all ports, or forwarded exclusively to all router ports (depending on the configuration).

In either case, packets are forwarded to all router ports.

### IGMP snooping through multiple bridges

As described, IGMP snooping only forwards incoming Join or Leave messages via router ports. In a structure with multiple bridges, initially none of the ports are router ports or members of a multicast group. If a station connected to the bridge registers with a multicast group, the port automatically becomes a member of this group. However, none of the ports are router ports at this phase, so the Join messages are not forwarded anywhere. Other bridges thus receive no information about the port's membership with the multicast group.

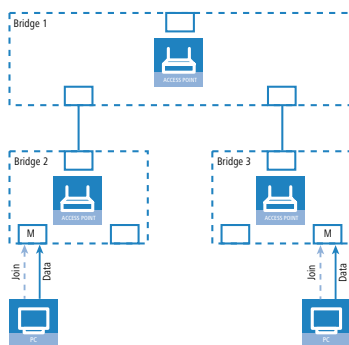

Consequently, bridges must have router ports in order for membership information to be propagated. Since the ports of a bridge only become router ports in the case of IGMP queries, one of the multicast-capable routers in the network must take over the task of distributing the necessary IGMP queries throughout the network. This router is referred to as the IGMP querier. If the network does not contain a multicast router, the LANCOM access points are capable of simulating a querier. To avoid parallel queries arriving from various queriers, a querier will deactivate itself if it discovers another querier with a lower IP number. The distribution of IGMP information by the querier can be explained with the following example:

1. The querier (Bridge 2 in this example) regularly sends out IGMP queries on all ports of bridge 2 (dotted lines). The next bridge (Bridge 1) receives the query on a port which is then marked as a router port (R). PC 1 responds to this query with a Join message for all multicast groups (light dashed lines). The port connecting PC 1 to Bridge 2 then becomes a member of the multicasting group(s).
2. In addition to this, Bridge 1 sends the queries on all other ports to the bridges and stations lower down in the structure. In Bridge 3 the port receiving the query becomes a router port (R).
3. The station (PC 2) connected to bridge 3 responds to this query with a Join message for all registered multicast groups. The port connecting PC 2 to Bridge 3 then becomes a member of the multicasting group(s).
4. Bridge 3 forwards this Join message to Bridge 1 over the router port. The receiving port on Bridge 1 thus also takes on membership of the multicast groups that PC 2 has registered for.
5. In the final step, Bridge 1 forwards the Join message from PC 2 via the router port to Bridge 2, where the receiving port also takes on membership of PC 2's multicast groups.

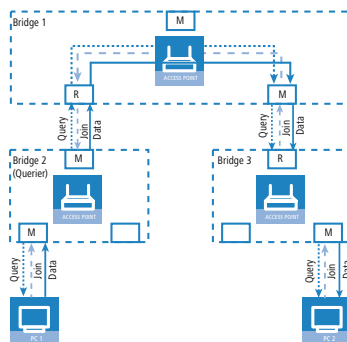

If PC 1 now transmits a multicast for which PC 2 has registered, all of the bridges (2, 1 and then 3) forward the packets to PC 2 via the member port.

## Configuration

### General settings

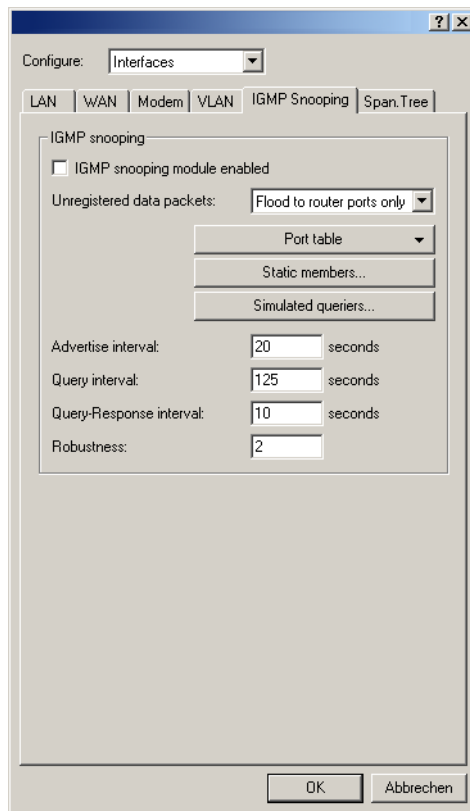

LANconfig: Interfaces / IGMP snooping

WEBconfig: LCOS menu tree / Setup / LAN bridge / IGMP snooping

#### ■ Operating

Activates or deactivates IGMP snooping in the device and all of the defined querier instances. Without IGMP snooping the bridge functions like a simple switch and forwards all multicasts to all ports.

Possible values:

- Yes, No

Default:

- No

! If this function is deactivated, all IP multicast packets are sent on all ports. If the device operating state changes, the IGMP snooping function is completely reset, i.e. all dynamically learned values are lost (membership, router-port states).

#### ■ Query interval

Interval in seconds in which a multicast-capable router (or a simulated querier) sends IGMP queries to the multicast address 224.0.0.1, so prompting the stations to transmit return messages about multicast group memberships. These regular queries influence the time in which memberships age, expire, and are then deleted.

- After the startup phase, the querier sends IGMP queries in this interval.
- A querier returns to the querier status after a time equal to "Robustness\*Query-Interval+(Query-Response-Interval/2)".

- A port loses its router-port status after a time equal to "Robustness\*Query-Interval+(Query-Response-Interval/2)".

Possible values:

- 10-figure number greater than 0.

Default:

- 125

---

 The query interval must be greater than the query response interval.

- Query response interval

Interval in seconds influencing the timing between IGMP queries and router-port aging and/or memberships.

Interval in seconds in which a multicast-capable router (or a simulated querier) expects to receive responses to its IGMP queries. These regular queries influence the time in which memberships age, expire, and are then deleted.

Possible values:

- 10-figure number greater than 0.

Default:

- 10

---

 The query response interval must be less than the query interval.

- Robustness

This value defined the robustness of the IGMP protocol. This option tolerates packet losses of IGMP queries with respect to Join messages.

Possible values:

- 10-figure number greater than 0.

Default:

- 2

- Advertise interval

The interval in seconds in which devices send packets advertising themselves as multicast routers. This information makes it quicker for other IGMP-snooping devices to find which of their ports are to operate as router ports. When activating its ports, a switch (for example) can query for multicast routers, and the router can respond to this query with an advertisement of this type. Under some circumstances this method can be much quicker than the alternative IGMP queries.

Possible values:

- 4 to 180 seconds.

Default:

- 20

- Unregistered data packet handling

This setting defines the handling of multicast data packets with a destination address outside the 224.0.0.x range and for which neither static memberships were defined nor were dynamic memberships learned.

Possible values:

- Router ports only: Sends these packets to all router ports.
- Flood: Sends these packets to all ports.
- Discard: Drops these packets.

Default:

- Router ports only

### Port settings

This table defines the port-related settings for IGMP snooping.

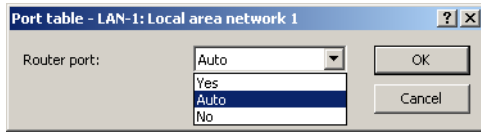

LANconfig: Interfaces / IGMP snooping / Port table

WEBconfig: LCOS menu tree / Setup / LAN bridge / IGMP snooping / Port settings

- Port

The port for which the settings apply.

Possible values:

- Selects a port from the list of those available in the device.

Default:

- N/A

- Router port

This option defines the port's behavior.

Possible values:

- Yes: This port will always work as a router port, irrespective of IGMP queries or router messages received at this port.
- No: This port will never work as a router port, irrespective of IGMP queries or router messages received at this port.
- Auto: This port will work as a router port if IGMP queries or router messages are received. The port loses this status if no packets are received for the duration of "Robustness\*Query-Interval+(Query-Response-Interval/2)".

Default:

- Auto

### Static members

This table enables members to be defined manually, for example if they cannot or should not be learned automatically.

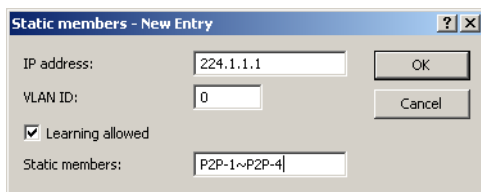

LANconfig: Interfaces / IGMP snooping / Static members

WEBconfig: LCOS menu tree / Setup / LAN bridge / IGMP snooping / Static members

- Address

The IP address of the manually defined multicast group.



Possible values:

- Valid IP multicast address.

Default:

- Blank

#### ■ VLAN ID

The VLAN ID which is to support this static member. Each IP multicast address can have multiple entries with different VLAN IDs.

Possible values:

- 0 to 4096.

Default:

- 0

Special values:

- If "0" is selected as VLAN, the IGMP queries are sent without a VLAN tag. For this reason, this value only makes sense when VLAN is deactivated in general.

#### ■ Allow learning

This option activates the automatic learning of memberships in this multicast group. If automatic learning is deactivated, packets can only be sent via the ports which have been manually defined for the multicast group.

Possible values:

- Yes, No.

Default:

- Yes

#### ■ Static members

These ports will always be the destination for packets with the corresponding IP multicast address, irrespective of any Join messages received.

Possible values:

- Comma-separated list of the desired ports, max. 215 alphanumerical characters.

Default:

- Blank

### Simulated queriers

This table contains all of the simulated queriers defined in the device. These units are employed if IGMP functions are required but there is no multicast router in the network. The querier can be limited to certain bridge groups or VLANs by defining multiple independent queriers to support the corresponding VLAN IDs.

LANconfig: Interfaces / IGMP snooping / Simulated queriers

WEBconfig: LCOS menu tree / Setup / LAN bridge / IGMP snooping / Simulated queriers

- Name  
Name of the querier instance  
Possible values:
  - 8 alphanumerical characters.Default:
  - Blank
- Operating  
Activates or deactivates the querier instance  
Possible values:
  - Yes, No.Default:
  - No
- Bridge group  
Limits the querier instance to a certain bridge group.  
Possible values:
  - Select from the list of available bridge groups.Default:
  - noneSpecial values:
  - If bridge group is set to "none", the IGMP queries will be sent via all bridge groups.
- VLAN ID  
Limits the querier instance to a certain VLAN.  
Possible values:
  - 0 to 4096.Default:
  - 0Special values:
  - If "0" is selected as VLAN, the IGMP queries are sent without a VLAN tag. For this reason, this value only makes sense when VLAN is deactivated in general.

## IGMP status

### General statistics

Status messages for IGMP snooping are to be found under the following paths:

WEBconfig: LCOS menu tree / Status / LAN bridge statistics / IGMP snooping

- Operating  
Indicates whether IGMP snooping is activated or deactivated.
- IPv4 packets

Shows the number of IPv4 multicast packets received at all ports, whether they were IGMP packets or not.

- Data packets

Shows the number of intact IPv4 multicast packets received at all ports and which were not IGMP packets.

- Control packets

Shows the number of intact IGMP packets received at all ports.

- Bad packets

Shows the number of damaged data or IGMP packets received at all ports. Possible causes for damage to packets may be IP checksum errors or truncated packets.



For performance reasons, IP checksums are evaluated for IGMP packets only and not for the data portion of multicast packets. This is why packets with a faulty checksum in the TCP/UDP or IP header are not detected. These packets are counted as data packets.

- Deleted values

This action deletes all statistical entries.

### Port status

This table shows all port-related statistics.

WEBconfig: LCOS menu tree / Status / LAN bridge / IGMP snooping / Port status

- Router port

Shows whether the port is currently in use as a router port or not, irrespective of whether this status was configured statically or learned dynamically.

- IPv4 packets

Shows the number of IPv4 multicast packets received at this port, whether they were IGMP packets or not.

- Data packets

Shows the number of intact IPv4 multicast packets received at this port and which were not IGMP packets.

- Control packets

Shows the number of intact IGMP packets received at this port.

- Bad packets

Shows the number of damaged data or IGMP packets received at this port. Possible causes for damage to packets may be IP checksum errors or truncated packets.



For performance reasons, IP checksums are evaluated for IGMP packets only and not for the data portion of multicast packets. This is why packets with a faulty checksum in the TCP/UDP or IP header are not detected. These packets are counted as data packets.

### Groups

This table displays all the the multicast group memberships known to the device, irrespective of whether they were configured statically or learned dynamically. If both static and dynamic memberships exist for a multicast group, these are shown in separate entries.

WEBconfig: LCOS menu tree / Status / LAN bridge / IGMP snooping / Groups

- Address

Shows the group's IP multicast address.

- VLAN ID

Shows the VLAN ID that this entry applies to.

- Allow learning  
Shows whether new memberships for this group can be learned dynamically or not.
- Static members  
Shows the list of statically defined members for this group.
- Dynamic members  
Shows the list of dynamically learned members for this group.

### Simulated queriers

This table shows the status of all defined and active IGMP querier instances.

- Name  
Shows the name of the multicast group.
- Bridge group  
Shows the bridge group that this entry applies to.
- VLAN ID  
Shows the VLAN that this entry applies to.
- Status  
Shows the current status of the entry.
  - Initial: The querier instance has just started and is sending IGMP queries in short intervals (four-times faster than the query interval defined).
  - Querier: The querier instance considers itself to be the active querier and is sending IGMP queries in the defined query interval.
  - Non-Querier: Another querier instance with a lower IP address has been detected, and the instance listed here is not sending any IGMP queries.

## 18.14.2 TACACS+

### Introduction

Tacacs+ (Terminal Access Controller Access-Control System) is a protocol for authentication, authorization and accounting (AAA). It thus provides access to the network for certain authorized users only, it regulates the rights of those users, and it is a logging mechanism to keep track of user actions. TACACS+ is an alternative to other AAA protocols such as RADIUS.

 TACACS+ must be used in order to meet with PCI compliance (Payment Card Industry).

Modern networks with their numerous types of service and network components present a massive challenge in terms of controlling access rights for the user. In large installations in particular, the overhead would be enormous to keep user data consistent on all devices or for all services. For this reason, user data should be managed on a central server.

As a simple example, a user wishes to register at a router and sends the corresponding login details (user ID) to it. In this case the router functions as a Network Access Server (NAS): It does not check the user data itself; rather, the data is forwarded to the central AAA server, which responds by checking the data and answering with an accept or a reject.



The advanced TACACS+ functions include, among others, the option of requesting user to change their passwords after logging in for the first time, or if the password has expired. The corresponding messages are sent from the NAS to the user.

- ⓘ Please note that LANconfig cannot process all of the messages in the extended login dialog. Should LANconfig reject a login attempt at a LANCOM even if the correct data is entered, please use an alternative method of configuration (such as WEBconfig or telnet).

TACACS+ is an alternative AAA server to the widespread RADIUS servers. The following table shows some of the major differences between RADIUS and TACACS+:

TACACS+	RADIUS
Connection-orientated data transfer via TCP	Connectionless data transfer via UDP
Fully encrypted data transfer	Password only encrypted, other content remains unencrypted
Complete separation of authentication, authorization and accounting possible	Authentication and authorization combined

- TCP-based communication with TACACS+ is more reliable than RADIUS. Communications between the NAS and AAA server are confirmed, so the NAS is always informed if the AAA server is unavailable.
- TACACS+ encrypts not only the password like RADIUS but the entire payload data (except for the TACACS+ header). This assures the confidentiality of information such as user names or the permitted services. TACACS+ encryption works with a one-time pad based on MD5 hashes.
- The separation of the three AAA functions enables TACACS+ to operate with multiple servers. Whereas RADIUS always combines authentication and authorization, TACACS+ allows these to be separated. In this way, for example, TACACS+ servers can be employed for authentication only, in that only the users are managed but not the permissible commands.

- ⓘ Please note: Even though TACACS+ is used to centrally manage user accounts on an AAA server, you should ensure that you set a secure password for root access to the LANCOM. If no root password is set, access to the device configuration can be blocked for security reasons if no connection is available to the TACACS+ server. In this case, the device may have to be reset to its factory settings in order to regain access to the configuration.

## Configuring the TACACS+ parameters

The parameters for configuring TACACS+ are to be found under the following paths:

WEBconfig: LCOS menu tree / Setup / TACACS+

- Accounting
 

Activates accounting via TACACS+ server. If TACACS+ accounting is activated, all accounting data is transmitted via TACACS+ protocol to the configured TACACS+ server.

Possible values:

- Activated, deactivated

Default

- Deactivated

- ⓘ TACACS+ accounting will only activate if the defined TACACS+ server is available.

- Authentication
 

Activates authentication via TACACS+ server. If TACACS+ authentication is activated, all authentication data is transmitted via TACACS+ protocol to the configured TACACS+ server.

Possible values:

- Activated, deactivated

Default

- Deactivated

---

 TACACS+ authentication will only activate if the defined TACACS+ server is available. Fallback to local users is only possible if a root password has been set for the LANCOM. The fallback to local users must be deactivated for devices without a root password. Otherwise a failure of the network connection (TACACS+ server unavailable) would make the LANCOM accessible without a password.

- Authorization

Activates authorization via TACACS+ server. If TACACS+ authorization is activated, all authorization data is transmitted via TACACS+ protocol to the configured TACACS+ server.

Possible values:

- Activated, deactivated

Default

- Deactivated

---

 TACACS+ authorization will only activate if the defined TACACS+ server is available. If TACACS+ authorization is activated, the TACACS+ server will be queried for authorization each time a user enters a command. Data traffic during configuration will increase correspondingly. Also, the user rights must be defined in the TACACS+ server.

- Fallback to local users

Should the defined TACACS+ server be unavailable, it is possible to fallback to local user accounts on the LANCOM. This allows for access to the device even if the TACACS+ connection should fail, e.g. when deactivating the usage of TACACS+ or for correcting the configuration.

Possible values:

- Allowed, prohibited

Default

- Allowed

---

 The fallback to local user accounts presents a security risk if no root password is set for the LANCOM. For this reason, TACACS+ authentication with fallback to local user accounts can only be activated if a root password has been set. If no root password is set, access to the device configuration can be blocked for security reasons if no connection is available to the TACACS+ server. In this case, the device may have to be reset to its factory settings in order to regain access to the configuration.

- Shared secret

The password for encrypting the communications between NAS and TACACS+ servers.

Possible values:

- 31 alphanumeric characters

Default

- Blank

---

 The password must be entered identically into the LANCOM and the TACACS+ server. We recommend that you do not operate TACACS+ without encryption.

- SNMP-GET requests accounting

Numerous network management tools use SNMP for requesting information from network devices. LANmonitor also uses SNMP to access the LANCOM devices to display information about current connections, etc., or to execute actions such as disconnecting a connection. SNMP can be used to configure devices. For this reason TACACS+ requires authentication for SNMP access requests. Since LANmonitor regularly queries these values, a large number of

unnecessary TACACS+ connections would be established. If authentication, authorization and accounting by TACACS+ are activated, then each request would initiate three sessions with the TACACS+ server.

This parameter allows the regulation of the behavior of LANCOM devices with regard to SNMP access in order to reduce the number of TACACS+ sessions required for accounting. Authentication via the TACACS+ server remains necessary if authentication for TACACS+ is activated generally.

 Entering a read-only community under LCOS menu tree / Setup / SNMP enables authentication by TACACS+ to be deactivated for LANmonitor. The read-only community defined here is then entered into LANmonitor as a user name.

Possible values:

- `only_for_SETUP_tree`: With this setting, accounting via TACACS+ server is only required for SNMP access via the setup branch of LCOS.
- `All`: With this setting, accounting by TACACS+ server will be carried out for every SNMP access. In case of regular request for status information, for example, the load on the TACACS+ server will increase significantly.
- `None`: With this setting, accounting by TACACS+ server will not be carried out for SNMP accesses.

Default:

- `only_for_SETUP_tree`
- SNMP-GET requests authorization

This parameter allows the regulation of the behavior of LANCOM devices with regard to SNMP access in order to reduce the number of TACACS+ sessions required for authorization. Authentication via the TACACS+ server remains necessary if authentication for TACACS+ is activated generally.

Possible values:

- `only_for_SETUP_tree`: With this setting, authorization via TACACS+ server is only required for SNMP access via the setup branch of LCOS.
- `All`: With this setting, authorization by TACACS+ server will be carried out for every SNMP access. In case of regular request for status information, for example, the load on the TACACS+ server will increase significantly.
- `None`: With this setting, authorization by TACACS+ server will not be carried out for SNMP accesses.

Default:

- `only_for_SETUP_tree`
- Encryption

Activates or deactivates the encryption of communications between NAS and TACACS+ servers.

Possible values:

- Activated, deactivated

Default

- Activated

 We recommend that you do not operate TACACS+ without encryption. If encryption is activated here, the password for encryption entered here must match with the password on the TACACS+ server.

## Configuring the TACACS+ server

Two servers can be defined to work with TACACS+ functions. One server acts as a backup in case the other one fails. When logging in via telnet or WEBconfig, the user can select the server to be used.

The parameters for configuring the TACACS+ server are to be found under the following paths:

WEBconfig: LCOS menu tree / Setup / TACACS+ / Server

- Server address

Address of the TACACS+ server to which requests for authentication, authorization and accounting are to be forwarded.

Possible values:

- Valid DNS resolvable name or valid IP address.

Default

- Blank

- Loopback address

Optionally you can configure a loopback address here.

Possible values:

- Name of the IP networks whose addresses are to be used
- "INT" for the address of the first intranet.
- "DMZ" for the address of the first DMZ.
- LB0 to LBF for the 16 loopback addresses
- Any valid IP address

Default

- Blank

- Compatibility mode

TACACS+ servers are available as open-source or commercial versions, each of which works with different messages. The compatibility mode enables the processing of messages from free TACACS+ servers.

Possible values:

- Activated, deactivated

Default

- Deactivated

## Login to the TACACS+ server

Once TACACS+ has been activated for authentication and/or authorization, all logins to the device are redirected to the TACACS+ server. The remaining login procedure differs according to the access method.

### TACACS+ login via LANconfig

Using LANconfig to login to a device with activated TACACS+ authentication is only possible with the user named "root". Correspondingly, the user "root" must be configured on the TACACS+ server. To login via LANconfig, enter the password as configured for the user "root" on the TACACS+ server.



ⓘ Once authenticated by TACACS+, "root" is the only user automatically assigned with full supervisor rights, and thus able to edit the configuration without having to change privilege level. When authorization is in use, the TACACS+ server decides whether this is allowed or not.



- ! If authorization is activated for the device as well as authentication, the TACACS+ server must permit the commands "readconfig" and "writeconfig" for the user "root" in order for the user to read the configuration from the device and to upload any changes.

### TACACS+ login via WEBconfig

Using WEBconfig to login to a device with activated TACACS+ authentication is possible for any user configured on the TACACS+ server. When logging in with WEBconfig, enter the user name configured on the TACACS+ server and select the server which is to carry out authentication.

The corresponding password is requested in the following dialog. After logging in, the user initially sees a reduced WEBconfig user interface. If authorization is not being used, all WEBconfig users (except for the user "root") initially have read rights only.

To gain further rights, click on the link **Change privilege level** on the left of the screen.

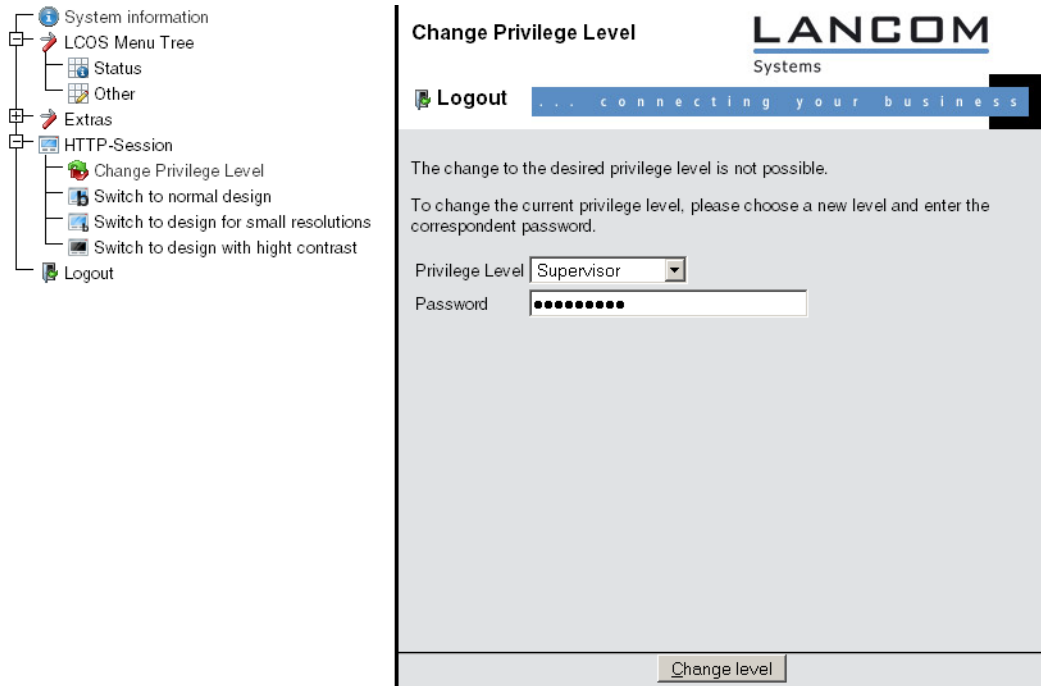

In this dialog you select the required user rights and enter the corresponding password.

- ! The passwords for individual user rights are configured as "enable" passwords in the TACACS+ server.
- ! If authorization is activated for the device as well as authentication, the TACACS+ server must permit the required commands for each user in order for the user to read and edit the device configuration.

### TACACS+ login with telnet or SSH

Using tenet or SSH to login to a device with activated TACACS+ authentication is possible for any user configured on the TACACS+ server.

When logging in with telnet, enter the user name configured on the TACACS+ server and select the server which is to carry out authentication. When logging in with SSH, enter the user name followed by a colon and then the server name, i.e. "user:1" or "user:2".

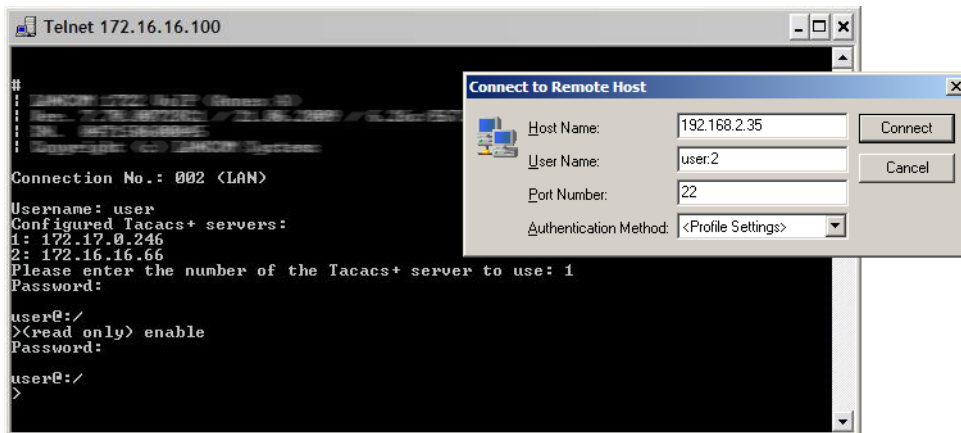

After login, all users initially have read-rights only (except for the user "root").

To gain further rights, enter the command `enable` and enter the password. Rights will be assigned according to configuration for that password. The parameters for the `enable` command are the numbers 1-15. 1 is the lowest level, 15 the highest. If no parameter is entered, 15 is taken automatically.

! The passwords for individual user rights are configured as "enable" passwords in the TACACS+ server.

! If authorization is activated for the device as well as authentication, the TACACS+ server must permit the required commands for each user in order for the user to read and edit the device configuration.

### Assigning rights under TACACS+

TACACS+ uses privilege levels to separate users into different groups. For the local authorization of users via the "enable" command under telnet/SSH or via privilege levels under WEBconfig, the various administrator rights of LCOS are mapped to the TACACS+ privilege levels:

TACACS+ level	LCOS administrator rights
0	No rights
1	Read only
3	Read-write
5	Read-only limited admin
7	Read-write limited admin
9	Read-only admin
11	Read-write admin
15	Supervisor (root)

### Authorizing functions

If authorization is activated for the device as well as authentication, the TACACS+ server must permit the corresponding functions for the user. Enter the required values into the user configuration on the TACACS+ server.

#### LANconfig

Command	Arguments	Remark
<code>readconfig</code>	none	Read out the entire configuration
<code>writeconfig</code>	none	Write the entire configuration

#### WEBconfig

Command	Arguments	Remark
<code>delRow</code>	SNMP-ID of the table	Delete row
<code>addRow</code>	SNMP-ID of the table	Add row
<code>editRow</code>	SNMP-ID of the table	Edit row
<code>modifyItem</code>	SNMP-ID of the menu item	Edit a menu item
<code>viewTable</code>	SNMP-ID of the table	View table
<code>viewRow</code>	SNMP-ID of the row	View row
<code>setValue</code>	SNMP-ID of the menu item	Set value of a menu item
<code>listmenu</code>	SNMP-ID of the menu	List sub menu
<code>action</code>	SNMP-ID of the action	Execute an action

Command	Arguments	Remark
reboot	none	Restart device
\$URL	none	Display a certain URL

 When working with WEBconfig, all URLs sent to the TACACS+ server during configuration must be enabled. For example, the URL "config2" under WEBconfig provides access to the configuration branch of the LCOS menu tree. Additionally, the individual parameters which the user may edit must also be enabled. You can view the URLs sent by WEBconfig to the TACACS+ server with the trace "trace+ tacacs".

### Telnet/SSH

Command	Arguments	Remark
dir	SNMP-ID of the directory	View directory content
list	SNMP-ID of the directory	View directory content
ls	SNMP-ID of the directory	View directory content
llong	SNMP-ID of the directory	View directory content
del	SNMP-ID of the table	Delete row
delete	SNMP-ID of the table	Delete row
rm	SNMP-ID of the table	Delete row
cd	SNMP-ID of the target directory	Change directory
add	SNMP-ID of the table	Add row
tab	SNMP-ID of the table	Changes the order of the columns for adding values
do	SNMP-ID of the action	Execute action
show	Parameter name	View information
trace	Parameter name	Execute trace
time	Parameter name	Time
feature	Parameter name	Add function
repeat	Parameter name	Repeat the command
readmib	none	Read-out SNMP-MIB
readconfig	none	Read out the entire configuration
readstatus	none	Read-out status menu
writeflash	none	Update firmware
activateimage	Parameter name	Activate another firmware image
ping	Parameter name	Start ping
wakeup	Parameter name	Sends wakeup packet
linktest	Parameter name	WLAN link test
writeconfig	none	Write the entire configuration
ll2mdetect	none	Start LL2M detection
ll2mexec	Parameter name	Execute LL2M command
scp	Parameter name	Secure copy
rcp	Parameter name	Secure copy

Command	Arguments	Remark
readscript	Parameter name	Read-out script
beginscript	none	Start script
endscript	none	Stop script
flash	Parameter name	Activate/deactivate flash mode

 For telnet access, all of the parameters that the user may edit must be enabled. You can view the values sent by telnet to the TACACS+ server with the trace "trace+ tacacs".

## SNMP

Command	Arguments	Remark
get	SNMP-ID of the menu item	Read-out value
set	SNMP-ID of the menu item	Set value

## Addition(s) to LCOS 7.80

### Bypassing TACACS+

#### Introduction

TACACS+ enables every change to a network-device configuration to be subject to special authorization. TACACS+ accounting enables each of these steps to be logged. TACACS+ is a requirement for systems used in electronic payment (PCI compliance).

Strict monitoring of this type leads to an increase in traffic to and from the TACACS+ server(s). In large-scale scenarios, the TACACS+ communications caused when using scripts for centralized configuration changes or if CRON commands are run regularly could lead to an overload of the TACACS+ server.

#### Configuration

To avoid overloading the TACACS+ server when carrying out automatic configuration changes, it is possible to exclude CRON, action tables and scripts from the authorization and accounting by TACACS+.

WEBconfig: LCOS menu tree / Setup / TACACS+

- Bypass-Tacacs-for-CRON/scripts/action-table

You can activate or deactivate the bypassing of TACACS+ authorization and TACACS+ accounting for various actions.

Possible values:

- Activated, deactivated.

Default:

- Disabled.

 Please observe that this option influences the TACACS+ function for the entire system. Be sure that you restrict the use of CRON, the action tables, and scripts only to an absolutely trustworthy circle of administrators!

## 18.15 Addition(s) to LCOS 8.00

### 18.15.1 Basic HTTP file server for LCOS 8.0

#### Introduction

The HTTP server integrated into the LCOS uses the HTTP protocol to connect to an external storage medium, so providing a basic data server.

This function is supported by all LANCOM devices with a USB connector.

#### Preparing the USB storage medium

The following describes how to set up a USB medium for operating with a LANCOM device:

- File system: Format the USB medium with the FAT16 or FAT32 file system.
- Base directory: Create the directory `public_html` on the USB medium. The LCOS HTTP server only accesses the files and subdirectories in this directory. All other files on the USB medium are ignored.
- USB connection: Connect the mass storage device to the USB connector on the LANCOM.

#### Determine the mount point of the USB medium in the LCOS

When a USB medium is connected to a LANCOM device, a mount point is created automatically for the LCOS's internal management of the medium. This mount point always remains the same for a certain USB medium, even after rebooting or restarting. Different media are each allocated their own unique mount point.

The mount point must be known in order to access the files on the USB medium. The mount points for USB media are shown in the status table:

- WEBconfig: LCOS menu tree / Setup / File system / Volumes

Volumes					
ID	Mountpoints	Filesystem	Unmountable?	Free	Size
BlkDev-1	/PKBACK#.001, /usb	FAT32	1	53382 KB	122 MB
MiniFs	/minifs	MiniFs	0	209 KB	256 KB

The status table displays all of the volumes discovered by the device.

- MiniFs is the flash file system integrated into most devices.
- BlkDev-n are descriptors for the known USB media. If there is just one USB mass storage device connected, it is named BlkDev-1 and is mounted under /usb.

#### Accessing the files on a USB medium

Use the following URL to access the files on the USB medium by using the HTTP server in the LCOS:

- `http://<IP address of device>/filesrv/<mount point>/<file name>`

If, for example, the file is named `coupon.jpeg` and it is stored in the base directory `public_html` of the only USB medium, then you can access it with the following link:

`http://<IP address of device>/filesrv/usb/coupon.jpeg`



Files can be accessed with HTTPS as well as HTTP.

## Supported content type

The HTTP server in the LCOS uses the file extension to determine the MIME content type required to display the content correctly in a browser. The following extensions are currently recognized and will be translated into the correct MIME content type:

- .htm and .html for HTML files
  - .gif, .jpg, .jpeg, .png, .bmp, .pcx for images in the corresponding format
  - .ico for icon files
  - .pdf for Adobe Acrobat PDF files
  - .css for cascading style sheet files

## Directory structure

The directory `public_html` can contain sub-directories. The LCOS HTTP server observes certain rules for accessing the directories:

- If a file named 'index.html' exists in the sub-directory, then this is sent to the HTTP client, or else:
- If a file named 'index.htm' exists in the sub-directory, then this is sent to the HTTP client, or else:
- The file server simply displays a list of the files and sub-directories in the main directory.

## 18.15.2 SSH client

### Introduction

In addition to an SSL server for the secure and authenticated dialing-in to LANCOM devices, LCOS also features an SSH client. This SSH client enables SSH connections to be established from a LANCOM device to a remote server, such as another LANCOM device or a Unix server. This function is highly useful if it is impossible to connect directly to a remote device, but by using an indirect connection via the LANCOM device that can be accessed from both subnets instead.

The SSH client can be started with simple commands at the command line interface, similar to the OpenSSH client on a Linux or Unix system.

### CLI arguments for the SSH client

The SSH connection to a remote system is initiated with the following command:

- `ssh [-?] [-h] [-b loopback-address] [-p port] [-C] [-j interval] [user@]host [command]`
  - `-?`, `-h`: Display a brief help text about the available arguments
  - `-b`: Specifies the loopback address to be used. This option is important in the context of ARF.
  - `-p`: Specifies the port to be used. If the port is not specified here, the default is TCP port 22.
  - `command`: The SSH client either starts an interactive shell on the remote system or it can execute a single command. If no command is entered, the interactive shell starts.
  - `user`: User name for logging in to the remote system. If you do not explicitly enter a user name here, then the user name for your current local session is used for logging in at the LCOS CLI.
  - `-C`: If this option is specified, the SSH client uses the zlib algorithm to attempt to negotiate a method for data compression with the remote system. If the remote system does not support compression, then the data is transmitted uncompressed. The use of compression is generally worthwhile only for slow connections (e.g. ISDN). With fast connections, the performance loss from the additional overhead due to compression tends to be greater than the gain from reduced data amounts.
  - `-j interval`: If the connection to the remote system is routed via a NAT router or a firewall, it may be worthwhile to leave the connection running permanently. With an interactive SSH session, data is not transferred at all at certain phases, which can lead to disconnection because of timeouts. In such cases the SSH client can regularly transmit keep-alive packets. These are irrelevant to the remote station, but they inform the gateway

that the connection is still being used. This argument specifies the interval in seconds for transmitting keep-alive packets. The keep-alive packets are only transmitted when the SSH client is not sending other data to the remote system.

## Public keys for authentication

Authentication with SSH works with public keys sent from the remote system. If an SSH client needs to connect to an SSH server, the server sends the public key to the client, which then looks for that key in its files. The following situations can occur here:

- The SSH client finds the key in its list of known server keys, and the key is allocated to the corresponding host name or IP address. The SSH connection can be established without further activity from the user.
- The SSH client does **not** find the key in its list of known server keys, and also no other key of the same type (RSA or DSS) for the corresponding host name or IP address. The SSH client assumes that this is the first connection to the server. It shows its public key and the associated fingerprint. The user can verify the key using a copy from another source, and can then decide whether the server should be stored in the list of known SSH servers. If the user declines this verification, the SSH connection is broken immediately.
- The SSH client finds a key for the corresponding host name or IP address, but this is different from the key currently in use. Both keys are displayed, but the SSH connection will be terminated because the SSH client suspects a man-in-the-middle attack. If the public key on the remote system was recently changed, then the administrator has to delete the outdated entry from the list of known servers.

After successfully verifying the server key, the administrator can enter the password for accessing the remote system. The password cannot be entered directly at the command line.

SSH connections are usually closed at the server, e.g. by entering "Exit" in the shell. Sometimes it may be necessary to close the SSH connection with the client, e.g. if the application on the server has problems. The SSH client in the LCOS uses the same character string as OpenSSH to close the connection, i.e. tilde - dot.

---

 If the LCOS CLI session itself was opened with an OpenSSH client, you must use the string tilde – tilde – dot; otherwise the wrong connection will be closed.

## Creating SSH keys

SSH authentication works with two different procedures:

- Interactive with password entry by keyboard
- By exchanging public keys

Keys have to be created for each individual as there are no predefined standard keys. For this reason, LANCOM devices with their factory settings only support authentication by password.

Keys are generated by entering the command `sshkeygen` at the command line on the device that the administrator want to run the SSH client on. The following syntax applies:

- `sshkeygen [-?] [-h] [-t dsa|rsa] [-b bits] [-f output-file]`
  - `-?`, `-h`: Display a brief help text about the available arguments
  - `-t`: This argument sets the key type.

SSH supports two types of key:

RSA keys are most widely used and have a length between 512 and 16384 bits. If possible you should work with keys of 1024 to 2048 bits in length.

DSS keys follow the standard set down by the National Institute of Standards and Technology (NIST) and are typically used in environments which are required to comply with the Federal Information Processing Standard (FIPS). DSS keys are always 1024 bits long, but they are slower to process than a corresponding RSA key.

An RSA type key will be generated if no key type is specified.

- `-b`: This argument sets the length of the RSA key in bits.



If no length is specified, the default value is 1024 bits.

- `-f`: Name for the output file of the key.

After generating the key, the public part must be transmitted to the remote system. The public part of the key can be displayed with the following command:

- `show ssh idkeys`

This command generates output similar to the following:

```
Configured Client-Side SSH Host Keys For User 'root':
ssh-rsa AAAAB3NzaC1yc2EAAAABEQAAAQEA2
8BtNFFlnAi8I5B1aOwq5g2YfwIX20/vMX+9SLZ
AJVAhFnhdOG4wjTpLVuaQRNIITpBESPaWPLqoA
...
wd0T0nkuNQ== root@sshctest
```

Even though the output is divided into a number of lines, it is a single key consisting of three parts:

- The first part shows the key type (ssh-rsa or ssh-dss).
- The second part is the binary output of the key itself, coded as Base64.
- The third part contains the host name and is intended for entering comments.

This file can be edited with a convenient function in WEBconfig (WEBconfig / Extras / Edit list of allowed SSH public keys). Copy the first and second parts and replace the third part with a list of users to limit the use of this key to a selection of LCOS administrators.

## Editing the files

During operations, the SSH client uses various files which may require manual editing.

### The list of known SSH servers

The SSH client uses the list of known SSH servers to store the corresponding key. This file is changed each time a connection is established to an SSH server for the first time and the administrator accepts the key displayed for the remote system.

Each key is stored to a line in this file and contains three fields:

- The name or IP address of the remote system as entered into the SSH command when establishing the connection.
- The key type, i.e. ssh-rsa or ssh-dss.
- The binary output of the key itself, coded as Base64.

 Once an administrator has accepted the public key of an SSH server, this key applies to all LCOS administrators; there is no differentiation at user level.

### The files `ssh_id_rsa` and `ssh_id_dsa`

These files contain the keys generated with the `sshkeygen` command, i.e. the keys for authenticating the remote SSH server in PEM format. The keys for all LCOS administrators are stored in a central file. This is accessible to root administrators only, although not for the uploading or downloading of files or certificates.

The ID files have the following structure, which defines the use of a key for a certain LCOS administrator:

```
*** User xyz
Key
*** End
```

## Priorities for SSH authentication

SSH authentication follows a strict order of priorities:

- The first method always attempts to authenticate by means of public key, unless the remote system does not support this method or the current LCOS administrator does not possess a public key.
- The second method is the interactive authentication by keyboard where public-key authentication is unavailable or when the remote system has rejected the public key of the current LCOS administrator. Depending on the application, interactive authentication may consist of exchanging a number of messages between the SSH client and SSH server. In the simplest case, the password just has to be entered one time.

## Rights for operating the SSH client

Rights to work with the SSH client can be allocated on an individual basis to each administrator of LANCOM devices.

The rights for the administrators are to be found in the following menu:

- LANconfig: Management / Admin / Additional administrators
- WEBconfig: LCOS menu tree / Setup / Config / Admins

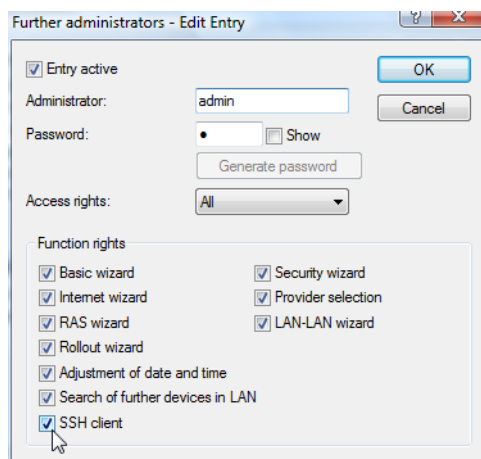

## 18.15.3 LANCOM Content Filter

### Introduction

The LANCOM Content Filter enables you to filter certain content from your network, so preventing access to Internet pages with content that is illegal or offensive. It also enables you to stop private surfing on specific sites during working hours. This not only increases staff productivity and network security but also ensures that the full bandwidth is available exclusively for your business activities.

The LANCOM Content Filter is an intelligent content filter that works dynamically. It contacts a rating server that evaluates Internet sites reliably and accurately in accordance with the categories that you select.

The LANCOM Content Filter operates by checking the IP addresses behind the URLs that are entered. For any given domain it is possible to differentiate according to the path, meaning that specific areas of a URL may be rated differently.

**!** It is not possible for users to avoid the LANCOM Content Filter website rating simply by entering the website's IP address into their browsers. The LANCOM Content Filter checks only unencrypted websites via HTTP.

The LANCOM Content Filter license you purchase is valid for a certain number of users and for a specific period (for one or three years). You will be informed of the expiry of your license in good time. The number of current users is monitored in the device, with the users being identified by their IP address. You can configure what should happen when the number of licensed users is exceeded: Access can either be denied or an unchecked connection can be made.

- ! You can test the LANCOM Content Filter on all router models, which generally support this function, by activating a demo license that is valid for 30-days. Demo licenses are generated directly with LANconfig. Click on the device with the right-hand mouse key and select the context menu entry **Activate software option**. In the dialog that follows, click on the button **Demo license**. You will automatically be connected to the website for the LANCOM registration server. Simply select the required demo license and you can register your device.

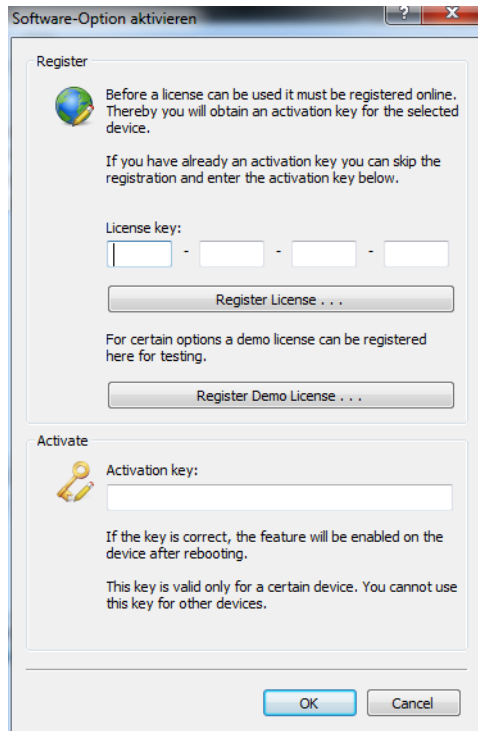

All settings relating to categories are stored in category profiles. You select from predefined main and sub-categories in the LANCOM Content Filter: 58 categories are divided into 14 subject groups such as "Pornography, Nudity", "Shopping" or "Illegal Activities". You can activate or deactivate each of the categories in these groups. Sub-categories for "Pornography/Nudity" are, for example, "Pornography/Erotic/Sex" and "Swimwear/Lingerie".

When configuring these categories, administrators have an additional option of activating an override. When the override option is active, users may still access the forbidden site for a particular period of time by clicking on a corresponding button, but the administrator will be notified of this by e-mail, syslog, or SNMP trap.

The category profile, whitelist and blacklist can be used to create a content filter profile that you can assign to particular users by means of the firewall. For example you can create a profile called "Employees\_department\_A" and assign this to all of the computers in that department.

When you install the LANCOM Content Filter, basic default settings are created automatically. These only need to be activated for the initial start. You can subsequently customize the behavior of the LANCOM Content Filter to match your own requirements.

## Requirements for using the LANCOM Content Filter

The following requirements must be met before you can use the LANCOM Content Filter:

1. The LANCOM Content Filter option has been activated.
2. The firewall must be activated and an appropriate firewall rule must select the content filter profile.
3. The content filter profile must specify a category profile and if desired a whitelist and or blacklist for each part of the day. A content filter profile can consist of several different entries to provide different levels of protection during different parts of the day.
  - If a certain part of the day is not covered by an entry, access to websites will go unchecked for this period.

 If the content filter profile is subsequently renamed, the firewall must also be modified.

## Quick start

After installing the LANCOM Content Filter, all the settings have been made to get it up and running quickly.

 The operation of the LANCOM Content Filter may be restricted by your country's data protection regulations or by company guidelines. Please check any regulations that may apply before putting the system into operation.

You activate the LANCOM Content Filter by:

1. Start the Setup Wizard for the device.
2. Select the Setup Wizard for configuring the Content Filter.



1. Select one of the pre-defined security profiles (basic, work, parental control):
  - Basic profile: This profile mainly blocks access to the categories pornography, illegal, violent or discriminatory content, drugs, SPAM and phishing
  - Work profile: In addition to the settings for the basic profile, this profile also blocks the categories shopping, job search, gaming, music, radio and certain communications services such as chat.
  - Parental-control profile: In addition to the settings for the basic profile, this profile also blocks nudity and weapons/military.

Should the firewall be deactivated, the Wizard will switch the firewall on. The Wizard then checks if the firewall rule is set correctly for the content filter and, if necessary, will take corrective measures. After activating the Content Filter with the steps outlined above, all stations in the network are being filtered according to the settings of the selected content-filter profile and the as-yet empty blacklist and whitelist. You can adapt these settings for your purposes, if necessary.

 Detailed information about manually configuring the content filter is available in the content filter manual available as a PDF on the CD or as a download from [www.lancom.eu](http://www.lancom.eu).

## Standard settings in the LANCOM Content Filter

The following elements have been created in the default configuration of the LANCOM Content Filter:

- A firewall rule
- Three firewall action objects
- Three content filter profiles
- Two timeframes

- A blacklist
- A whitelist
- Three category profiles

### Firewall rule

The preset firewall rule is named CONTENT-FILTER and uses the action object CONTENT-FILTER-BASIC.

 The firewall rule is not created automatically if the LANCOM Content Filter is installed on a device that has been configured already. The rule must be added manually. This firewall rule must include one of the action objects that are pre-defined for the Content Filter.

### Firewall action objects

There are three firewall action objects: CONTENT-FILTER-BASIC, CONTENT-FILTER-WORK and CONTENT-FILTER-PARENTAL-CONTROL. These action objects work with the corresponding content-filter profiles.

### Content filter profiles

There are three content filter profiles. All content-filter profiles use the timeframe ALWAYS, the blacklist MY-BLACKLIST and the whitelist MY-WHITELIST. Each content-filter profile uses one of the predefined category profiles:

- CF-BASIC-PROFILE: This content-filter profile features a low level of restrictions and works with the category profile BASIC-CATEGORIES.
- CF-PARENTAL-CONTROL-PROFILE: This content-filter profile protects minors (e.g. trainees) from unsuitable Internet content, and it works with the category profile PARENTAL-CONTROL.
- CF-WORK-PROFILE: This content-filter profile is intended for companies wishing to place restrictions on categories such as Job Search or Chat. It works with the category profile WORK-CATEGORIES.

Name	Time frame	Blacklisted	Whitelisted	Category profile
CF-BASIC-PROFILE	ALWAYS	MY-BLACKLIST	MY-WHITELIST	BASIC-CATEGORIES
CF-PARENTAL-CONTROL-PROFILE	ALWAYS	MY-BLACKLIST	MY-WHITELIST	PARENTAL-CONTROL
CF-WORK-PROFILE	ALWAYS	MY-BLACKLIST	MY-WHITELIST	WORK-CATEGORIES

### Timeframe

There are two predefined timeframes:

- ALWAYS: 00.00-23.59 hrs
- NEVER: 00.00-0.00 hrs

### Blacklist

The preset blacklist is named "MY-BLACKLIST" and it is empty. Here you can optionally enter URLs which are to be forbidden.

### Whitelist

The preset whitelist is named "MY-WHITELIST" and it is empty. Here you can optionally enter URLs which are to be allowed.

### Category profiles

There are three category profiles: BASIC-CATEGORIES, WORK-CATEGORIES and PARENTAL-CONTROL. The category profile specifies the categories which are to be allowed and forbidden, and for which one an override can be activated.

## General settings

Global settings for the LANCOM Content Filter are made here:

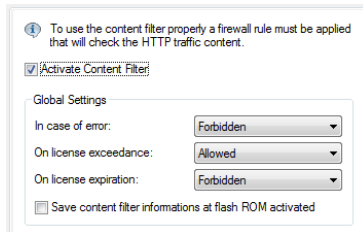

LANconfig: Content-Filter / General

WEBconfig: LCOS menu tree / Setup / UTM / Content-Filter / Global-Settings

### ■ Operating

This is where you can activate the LANCOM Content Filter.

### ■ Action-on-Error:

This is where you can determine what should happen when an error occurs. For example, if the rating server cannot be contacted, this settings either allows the user to surf without restrictions or access to the entire web is blocked.

Possible values:

- Block, Pass

Default:

- Block

### ■ Action-on-License-Exceedance:

This is where you can determine what should happen when the licensed number of users is exceeded. Users are identified by their IP address. The system keeps count of the IP addresses that connect via the LANCOM Content Filter. When the eleventh user establishes a connection with a 10-user license, no further checking is performed by the LANCOM Content Filter. Depending on this setting, the unlicensed user can either surf the web without restrictions, or access to the entire web is blocked.

Possible values:

- Block, Pass

Default:

- Block



The users of the content filter are automatically removed from the user list when no connection has been made from the IP address concerned via the content filter for 24 hours.

### ■ Action-on-License-Expiration:

The license to use the LANCOM Content Filter is valid for a certain period. You will be reminded of the license expiry date 30 days, one week and one day before it actually expires (at the e-mail address configured in LANconfig: Log & Trace / General).

This is where you can specify what should happen when the license expires (i.e. block everything or allow everything through). After the license used expires, this setting either allows the user to surf the web without restrictions, or access to the entire web is blocked.

Possible values:

- Block, Pass

Default:

- Block

## Settings for blocking

You adjust the website-blocking settings here:

The screenshot shows a configuration window for blocking settings. At the top, there is a text input field labeled 'Alternative blocking URL:' containing the text 'www.mycompany.com/block'. Below this is a label 'A text to be shown at blocking can be defined here.' followed by a button labeled 'Block text...'. Underneath is another label 'A text to be shown on error can be defined here.' followed by a button labeled 'Error text...'. A horizontal line separates this section from the next. Below the line is an information icon (i) and a paragraph: 'The device determines the correct source address for the destination network automatically. If a certain source address should be used insert it here.' Below this is a label 'Alt. source IP for block URL:' followed by a dropdown menu.

LANconfig: Content-Filter / Blocking

WEBconfig: LCOS menu tree / Setup / UTM / Content-Filter / Global-Settings

- URL-To-Show-On-Blocking:

This is where you can enter the address of an alternative URL. If access is blocked, the URL entered here will be displayed instead of the requested website. You can use this external HTML page to display your company's corporate design, for example, or to perform functions such as JavaScript routines, etc. You can also use the same HTML tags here as in blocking text. If you do not make any entry here, the default page stored in the device will be displayed..

Possible values:

- Valid URL address

Default:

- Blank

- Loopback-To-Use-On-Blocking:

This is where you can configure an optional sender address to be used instead of the one that would normally be automatically selected for this target address. If you have configured loopback addresses you can specify them here as sender address.

Possible values:

- Name of the IP networks whose address should be used
- "INT" for the address of the first intranet
- "DMZ" for the address of the first DMZ (caution: If there is an interface called "DMZ", its address will be taken in this case)
- LBO ... LBF for the 16 loopback addresses
- GUEST

- Any IP address in the form x.x.x.x

Default:

- Blank

! The sender address specified here is used unmasked for every remote station.

### Block-Text

This is where you can define text to be displayed when blocking occurs. Different blocking texts can be defined for different languages. The display of blocking text is controlled by the language setting transmitted by the browser (user agent).

Language	Text
default	The site <CF-URL/> is blocked because <CF-IF BL>it is blacklisted by the administrator
de	Die Webseite <CF-URL/> wurde blockiert, da <CF-IF BL>sie vom Administrator verboten
en	The site <CF-URL/> is blocked because <CF-IF BL>it is blacklisted by the administrator

- Language

Entering the appropriate country code here ensures that users receive all messages in their browser's preset language. If the country code set in the browser is found here, the matching text will be displayed.

You can add any other language.

Examples of the country code:

- de-DE: German-Germany
- de-CH: German-Switzerland
- de-AT: German-Austria
- en-GB: English-Great Britain
- en-US: English-USA

! The country code must match the browser language setting exactly, e.g, "de-DE" must be entered for German ("de" on its own is not sufficient). If the country code set in the browser is not found in this table, or if the text stored under that country code is deleted, the predefined default text ("default") will be used. You can modify the default text.

Possible values:

- 10 alphanumerical characters

Default:

- Blank

- Text

Enter the text that you wish to use as blocking text for this language.

Possible values:

- 254 alphanumerical characters

Default:

- Blank

Special values:



You can also use special tags for blocking text if you wish to display different pages depending on the reason why the website was blocked (e.g. forbidden category or entry in the blacklist).

The following tags can be used as tag values:

- `<CF-URL/>` for a forbidden URL
- `<CF-CATEGORIES/>` for the list of categories why the website was blocked
- `<CF-PROFILE/>` for the profile name
- `<CF-OVERRIDEURL/>` for the URL used to activate the URL (this can be integrated in a simple `<a>` tag or in a button)
- `<CF-LINK/>` adds a link for activating the override
- `<CF-BUTTON/>` for a button for activating the override

You can use a tag with attributes to display or hide parts of the HTML document: `<CF-IF att1 att2> ... </CF-IF>`.

Possible attributes are:

- **BLACKLIST**: If the site was blocked because it is in the profile blacklist
- **CATEGORY**: If the site was blocked due to one of its categories
- **ERR**: If an error has occurred.

Since there are separate text tables for the blocking page and the error page, this tag only makes sense if you have configured an alternative URL to show on blocking.

- **OVERRIDEOK**: If users have been allowed an override (in this case, the page should display an appropriate button)

If several attributes are defined in one tag, the section will be displayed if at least one of these conditions is met. All tags and attributes can be abbreviated to the first two letters (e.g. `CF-CA` or `CF-IF BL`). This is necessary as the blocking text may only contain a maximum of 254 characters.

- Example:

```
<CF-URL/> is blocked because it matches the categories <CF-CA/>.
Your content profile is <CF-PR/>.
<CF-IF
OVERRIDEOK>
<CF-BU/></CF-IF>
```

! The tags described here can also be used in external HTML pages (alternative URLs to show on blocking).

## Error-Text

This is where you can define text to be displayed when an error occurs.

Language	Text
default	The site <CF-URL/> is blocked because <CF-IF BL>it is blacklisted by the administr
de	Die Webseite <CF-URL/> wurde blockiert, da <CF-IF BL>sie vom Administrator ver
en	The site <CF-URL/> is blocked because <CF-IF BL>it is blacklisted by the administr

- Language

Entering the appropriate country code here ensures that users receive all messages in their browser's preset language. If the country code set in the browser is found here, the matching text will be displayed.

You can add any other language.

Examples of the country code:

- de-DE: German-Germany
- de-CH: German-Switzerland
- de-AT: German-Austria
- en-GB: English-Great Britain
- en-US: English-USA

-  The country code must match the browser language setting exactly, e.g, "de-DE" must be entered for German ("de" on its own is not sufficient). If the country code set in the browser is not found in this table, or if the text stored under that country code is deleted, the predefined default text ("default") will be used. You can modify the default text.

Possible values:

- 10 alphanumerical characters

Default:

- Blank
- Text

Enter the text that you wish to use as error text for this language.

Possible values:

- 254 alphanumerical characters

Default:

- Blank

Special values:

You can also use HTML tags for the error text.

The following empty element tags can be used as tag values:

- <CF-URL/> for a forbidden URL
- <CF-PROFILE/> for the profile name
- <CF-ERROR/> for the error message
- Example:

<CF-URL/> is blocked because an error has occurred:<br><CF-ERROR/>

## Override settings

The override function allows a website to be accessed even though it is classified as forbidden. The user must click on the override button to confirm that the forbidden page should be opened. You can configure this feature so that the administrator is notified when the override button is clicked (LANconfig: Content-Filter / Global-Settings).

-  If the override type "Category" has been activated, clicking on the override button makes **all** of the categories for that URL accessible to the user. The next blocking page to be displayed has just one category explaining why access to the URL was blocked. After clicking on the override button, all of the allowed categories are displayed. If the override type "Domain" has been activated, then the entire domain can be accessed.

The settings for the override function are to be found here:

LANconfig: Content-Filter / Override

WEBconfig: LCOS menu tree / Setup / UTM / Content-Filter / Global-Settings

- **Override-Active**

This is where you can activate the override function and make further related settings.

- **Override-Duration**

The override duration can be restricted here. When the period expires, any attempt to access the same domain and/or category will be blocked again. Clicking on the override button once more allows the website to be accessed again for the duration of the override and, depending on the settings, the administrator will be notified once more.

Possible values:

- 1-1440 (minutes)

Default:

- 5 (minutes)

- **Override-Type:**

This is where you can set the type of override. It can be allowed for the domain, for the category of website to be blocked, or for both.

Possible values:

- **Category:** For the duration of the override, all URLs are allowed that fall under the affected categories (as well as those which would already have been allowed even without the override).
- **Domain:** For the duration of the override all URLs in this domain are allowed, irrespective of the categories they belong to.
- **Category-and-Domain:** For the duration of the override, all URLs are allowed that belong to this domain and also to the allowed categories. This is the highest restriction.

Default:

- **Category-and-Domain**

- URL-To-Show-On-Override:

This is where you can enter the address of an alternative URL. In the event of an override, the URL entered here will be displayed instead of the usual website. You can use this external HTML page to display your company's corporate design, for example, or to perform functions such as JavaScript routines, etc. You can also use the same tags here as in the override text. If you do not make any entry here, the default page stored in the device will be displayed..

Possible values:

- Valid URL address

Default:

- Blank

- Loopback-To-Use-On-Override:

- This is where you can configure an optional sender address to be used instead of the one that would normally be automatically selected for this target address. If you have configured loopback addresses you can specify them here as sender address.

Possible values:

- Name of the IP networks whose address should be used
- "INT" for the address of the first intranet
- "DMZ" for the address of the first DMZ (caution: If there is an interface called "DMZ", its address will be taken in this case)
- LBO ... LBF for the 16 loopback addresses
- GUEST
- Any IP address in the form x.x.x.x

Default:

- Blank



The sender address specified here is used unmasked for every remote station.

### Override text

This is where you can define text that is displayed to users confirming an override.

Language	Text
default	<CF-IF OK>Successfully override </CF-IF> <CF-IF CA BO>the categories <CF-CAT/></CF-IF>
de	<CF-IF CA BO>Die Kategorien <CF-CAT/> sind</CF-IF><CF-IF BO> auf der Seite <CF-DO/></CF-IF>
en	<CF-IF OK>Successfully override </CF-IF><CF-IF CA BO>the categories <CF-CAT/></CF-IF>

- Language

Entering the appropriate country code here ensures that users receive all messages in their browser's preset language. If the country code set in the browser is found here, the matching text will be displayed.

You can add any other language.

Examples of the country code:

- de-DE: German-Germany
- de-CH: German-Switzerland
- de-AT: German-Austria
- en-GB: English-Great Britain
- en-US: English-USA

 The country code must match the browser language setting exactly, e.g, "de-DE" must be entered for German ("de" on its own is not sufficient). If the country code set in the browser is not found in this table, or if the text stored under that country code is deleted, the predefined default text ("default") will be used. You can modify the default text.

Possible values:

- 10 alphanumerical characters

Default:

- Blank

#### ■ Text

Enter the text that you wish to use as override text for this language.

Possible values:

- 254 alphanumerical characters

Default:

- Blank

Special values:

You can also use HTML tags for blocking text if you wish to display different pages depending on the reason why the website was blocked (e.g. forbidden category or entry in the blacklist).

The following tags can be used as tag values:

- `<CF-URL/>` for the originally forbidden URL that is now allowed
- `<CF-CATEGORIES/>` for the list of categories that have now been allowed as a result of the override (except if domain override is specified).
- `<CF-BUTTON/>` displays an override button that forwards the browser to the original URL.
- `<CF-BUTTON/>` displays an override link that forwards the browser to the original URL.
- `<CF-HOST/>` or `<CF-DOMAIN/>` displays the host or the domain for the allowed URL. The tags are of equal value and their use is optional.
- `<CF-ERROR/>` generates an error message in the event that the override fails.
- `<CF-DURATION/>` displays the override duration in minutes.

You can use a tag with attributes to display or hide parts of the HTML document: `<CF-IF att1 att2> ... </CF-IF>`.

Attributes can be:

- CATEGORY when the override type is "Category" and the override was successful
- DOMAIN when the override type is "Domain" and the override was successful
- BOTH when the override type is "Category-and-Domain" and the override was successful
- ERROR when the override fails
- OK if either CATEGORY or DOMAIN or BOTH are applicable

If several attributes are defined in one tag, the section should be displayed if at least one of these conditions is met. All tags and attributes can be abbreviated to the first two letters (e.g. CF-CA or CF-IF BL). This is necessary as the blocking text may only contain a maximum of 254 characters.

- Example:

```
<CF-IF CA BO>Categories <CF-CAT/> are </CF-IF><CF-IF BO> in domain <CF-DO/></CF-IF><CF-IF DO>. Access to
domain <CF-DO/> is allowed for </CF-IF><CF-IF OK> für <CF-DU/> minutes.
<CF-LI/></CF-IF><CF-IF
ERR>Override error :
<CF-ERR/></CF-IF>
```

## Profiles in the LANCOM Content Filter

This is where you can create content filter profiles that are used to check websites for prohibited content. A content filter profile always has a name and, for various time periods, it activates the desired category profile and, optionally, a blacklist and a whitelist.

In order to provide different configurations for the various timeframes, several content-filter profile entries are created with the same name. The content filter profile is thus made up of the sum of all entries with the same name.

The firewall refers to this content-filter profile.

 Please note that you must make corresponding settings in the firewall in order to use the profiles in the LANCOM Content Filter.

### Profiles

The settings for the profiles are to be found here:

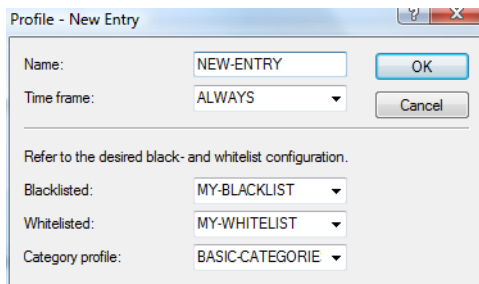

LANconfig: Content-Filter / Profiles / Profiles

WEBconfig: LCOS menu tree / Setup / UTM / Content-Filter / Profiles / Profiles

#### ■ Name

The profile name that the firewall references must be specified here.

Possible values:

- Name of a profile

Default:

- Blank

#### ■ Timeframe

Select the timeframe for this category profile and, optionally, the blacklist and the whitelist. The timeframes "ALWAYS" and "NEVER" are predefined. You can configure other timeframes under:

LANconfig: Date/Time / General / Timeframe

WEBconfig: LCOS menu tree / Setup / Time / Timeframe

One profile may have several lines with different timeframes.

Possible values:

- Always
- Never
- Name of a timeframe profile

Default:

- Blank

❗ If timeframes overlap when multiple entries are used for a content filter profile, all pages contained in one of the active entries will be blocked for that period of time. If a period remains undefined when several entries are used for a content filter profile, access to all websites is unchecked for this period.

#### ■ Blacklist

Name of the blacklist profile that is to apply for this content filter profile during the period in question. A new name can be entered, or an existing name can be selected from the blacklist table.

Possible values:

- Name of a blacklist profile
- New name

Default:

- Blank

#### ■ Whitelist

Name of the whitelist profile that is to apply for this content filter profile during the period in question. A new name can be entered, or an existing name can be selected from the whitelist table.

Possible values:

- Name of a whitelist profile
- New name

Default:

- Blank

#### ■ Category-Profile

Name of the category profile that is to apply for this content filter profile during the period in question. A new name can be entered, or an existing name can be selected from the category table.

Possible values:

- Name of a category profile
- New name

Default:

- Blank

### Blacklist addresses (URL)

This is where you can configure websites which are to be blocked.

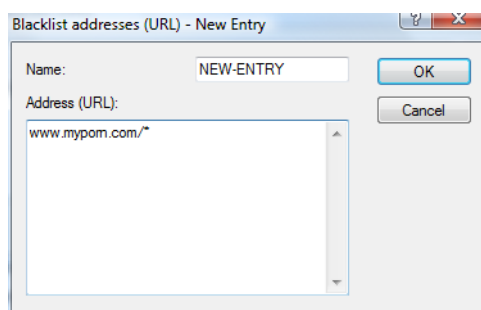

LANconfig: Content-Filter / Profiles / Blacklist addresses (URL)

WEBconfig: LCOS menu tree / Setup / UTM / Content-Filter / Profiles / Blacklists

- Name

Enter the name of the blacklist for referencing from the content-filter profile.

Possible values:

- Blacklist name

Default:

- Blank

- Address (URL)

Access to the URLs entered here will be forbidden by the blacklist.

Possible values:

- Valid URL address

The following wildcard characters may be used:

- \* for any combination of more than one character (e.g. www.lancom.\* encompasses the websites www.lancom.de, www.lancom.eu, www.lancom.es, etc.)
- ? for any single character (e.g. encompasses www.lancom.e\* the websites www.lancom.eu and www.lancom.es)

ⓘ Please enter the URL **without** the leading http://. Please note that in the case of many URLs a forward slash is automatically added as a suffix to the URL, e.g. www.mycompany.de/. For this reason it is advisable to enter the URL as: www.mycompany.de\* .

Individual URLs are separated by a blank.

Default:

- Blank

### Whitelist addresses (URL)

This is where you can configure websites to which access is to be allowed.

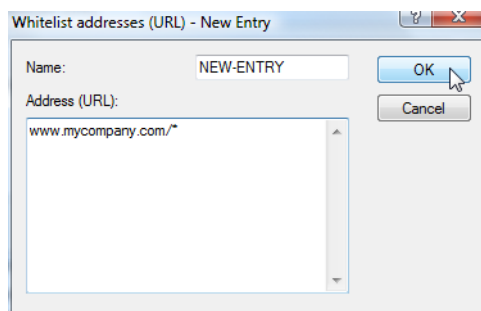

LANconfig: Content-Filter / Profiles / Whitelist addresses (URL)

WEBconfig: LCOS menu tree / Setup / UTM / Content-Filter / Profiles / Whitelists

- Name

Enter the name of the whitelist for referencing from the content-filter profile.

Possible values:

- Name of a whitelist

Default:

- Blank



- Addresses (URL)

This is where you can configure websites which are to be checked locally and then accepted.

Possible values:

- Valid URL address

The following wildcard characters may be used:

- \* for any combination of more than one character (e.g. www.lancom.\* encompasses the websites www.lancom.de, www.lancom.en, www.lancom.es, etc.)
- ? for any single character (e.g. encompasses www.lancom.e\* the websites www.lancom.en and www.lancom.es)

ⓘ Please enter the URL **without** the leading http://. Please note that in the case of many URLs a forward slash is automatically added as a suffix to the URL, e.g. www.mycompany.de/. For this reason it is advisable to enter the URL as: www.mycompany.de\* .

Individual URLs are separated by a blank.

Default:

- Blank

### Category-Profiles

Here you create a category profile and determine which categories or groups should be used to rate websites for each category profile. You can allow or forbid the individual categories or activate the override function for each group.

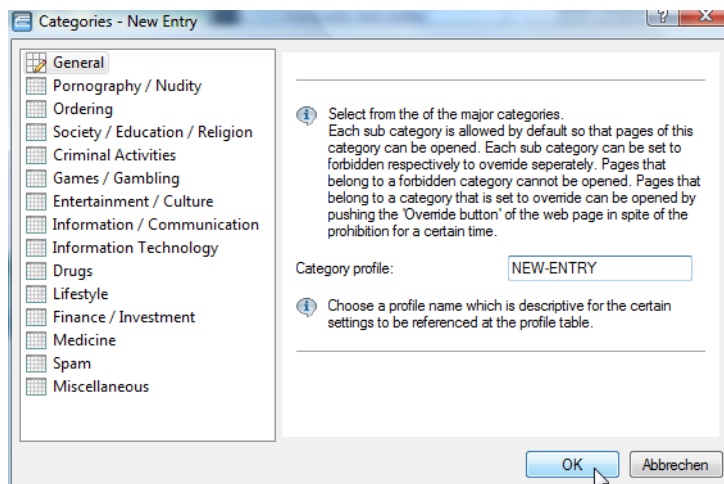

LANconfig: Content-Filter / Profiles / Categories

WEBconfig: LCOS menu tree / Setup / UTM / Content-Filter / Profiles / Category-Profiles

- Category profile

The name of the category profile for referencing from the content-filter profile is entered here.

Possible values:

- Name of a category profile

Default:

- Blank

- Category settings

For each main category and the associated sub-categories, it is possible to define whether the URLs are to be allowed, forbidden or allowed with override only.

The following main categories can be configured:

- Pornography/Nudity
- Shopping
- Society/Education/Religion
- Illegal Activities
- Games/Gaming
- Entertainment/Culture
- Information/Communication
- Information Technology
- Drugs
- Lifestyle
- Finance/Investment
- Medicine
- Spam
- Miscellaneous

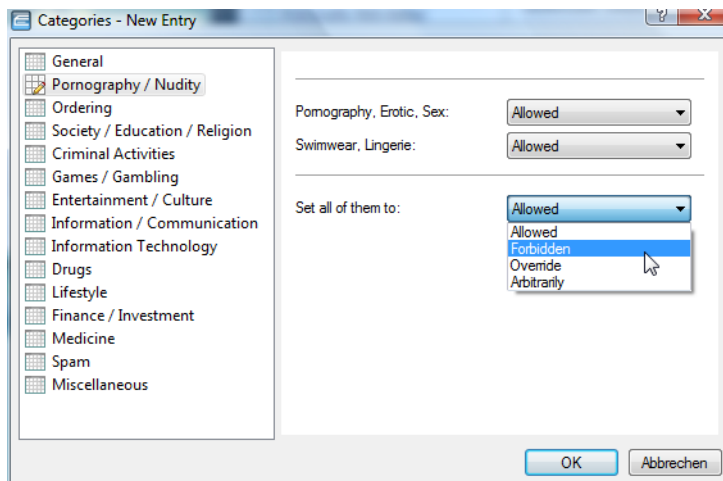

The category profile must subsequently be assigned to a content-filter profile (together with a timeframe) to become active.

Possible values:

- Allowed, forbidden, override

Default:

- Allowed

## Options with the LANCOM Content Filter

This is where you can determine whether you wish to be notified of events and where LANCOM Content Filter information is to be stored.

The screenshot shows a configuration window with two main sections:

- Event notification:**
  - Text: "Here you may define how to be informed about particular events."
  - Button: "Events..."
  - E-Mail recipient: "admin@mycompany.com"
- Save information:**
  - Text: "Specify whether the device should regularly store an content filter snapshot."
  - Checkbox:  "Content filter snapshot activated"
  - Interval: "monthly" (dropdown menu)
  - Day of month: "1" (input field)
  - Day of week: "Sunday" (dropdown menu)
  - Time of day: "00 : 00" (input field)

LANconfig: Content-Filter / Options

WEBconfig: LCOS menu tree / Setup / UTM / Content-Filter / Global-Settings

- Events:

This is where you define how you wish to receive notification of specific events. Notification can be made by e-mail, SNMP or SYSLOG. You can specify that messages for different events should be output in different ways.

Error:

- For SYSLOG: Source "System", priority "Alarm".
- Default: SNMP notification

License expiration:

- For SYSLOG: Source "Admin", priority "Alarm".
- Default: SNMP notification

License exceeded:

- For SYSLOG: Source "Admin", priority "Alarm".
- Default: SNMP notification

Override applied:

- For SYSLOG: Source "Router", priority "Alarm".
- Default: SNMP notification

Proxy Limit:

- For SYSLOG: Source "Admin", priority "Info".

- Default: SNMP notification

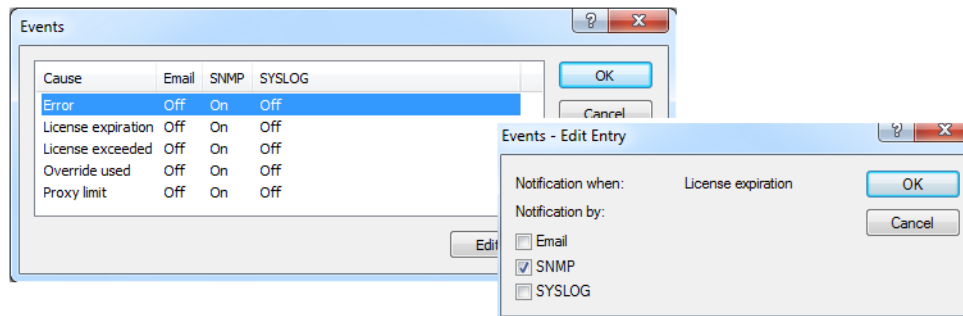

- E-mail recipient:

An SMTP client must be defined if you wish to use the e-mail notification function. You can use the client in the device, or another client of your choice.

! No e-mail will be sent if no e-mail recipient is defined.

WEBconfig: LCOS menu tree / Setup / UTM / Content-Filter / Global-Settings / Snapshot

- Content-Filter-Snapshot

This is where you can activate the content filter snapshot and determine when and how often it should be taken. The snapshot copies the category statistics table to the last snapshot table, overwriting the old contents of the snapshot table. The category statistics values are then reset to 0.

- Interval

Here you decide whether the snapshot should be taken monthly, weekly or daily.

Possible values:

- Monthly
- Weekly
- Daily

Default:

- Monthly

- Day of month:

For monthly snapshots, set the day of the month when the snapshot should be taken.

Possible values:

- Max. 2 characters

Default:

- 1

! It is advisable to select a number between 1 and 28 in order to ensure that it occurs every month.

- Weekday:

For weekly snapshots, set the day of the week when the snapshot should be taken.

Possible values:

- Monday, Tuesday, Wednesday, Thursday, Friday, Saturday, Sunday

Default:

- Monday
- Time:
 

If you require a daily snapshot, then enter here the time of day for the snapshot in hours and minutes.

Possible values:

  - Maximum 5 characters, format HH:MM

Default:

  - 00:00

## Additional settings for the LANCOM Content Filter

### Firewall settings for the content filter

The firewall must be activated in order for the LANCOM Content Filter to function. You can activate the firewall under:

LANconfig: Firewall/QoS / General

WEBconfig: LCOS menu tree / Setup / IP-Router / Firewall

In the default configuration, you will find the firewall rule CONTENT-FILTER that refers to the action object CONTENT-FILTER-BASIC:

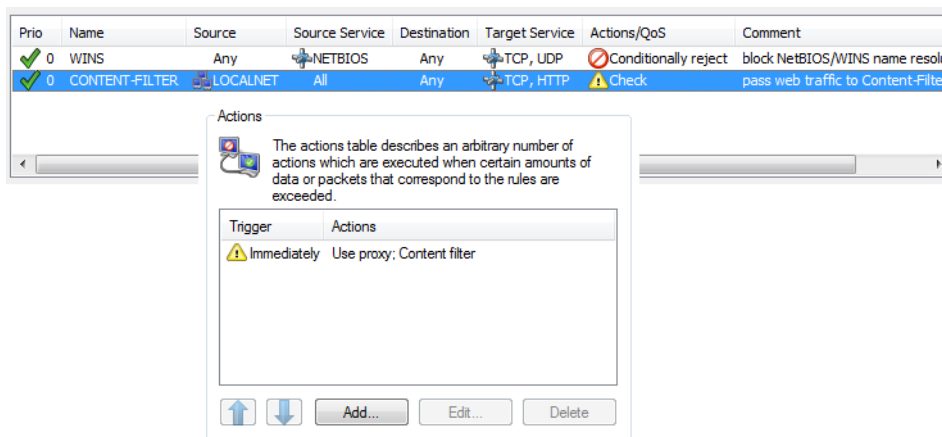

⚠ The firewall rule should be limited to the target service "http" so that only outgoing HTTP connections are examined. Without this restriction all packets will be checked by the content filter, which could lead to a loss of system performance.

A content-filter related firewall rule must contain a special action object that uses packet actions to check the data according to a content-filter profile. In the default configuration you will find the action objects CONTENT-FILTER-BASIC,

CONTENT-FILTER-WORK and CONTENT-FILTER-PARENTAL-CONTROL, each of which refer to their corresponding content-filter profile:

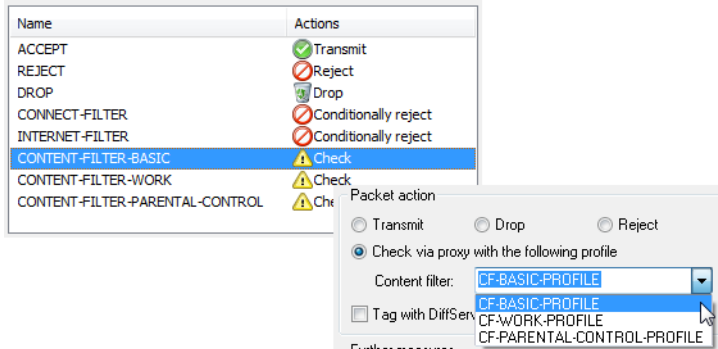

Example: When a web page is accessed, the data packets pass through the firewall and are processed by the rule CONTENT-FILTER. The action object CONTENT-FILTER-BASIC checks the data packets using the content-filter profile CONTENT-FILTER-BASIC.

**Timeframe**

Timeframes are used to define the periods when the content-filter profiles are valid. One profile may have several lines with different timeframes. Different lines in a timeframe should complement each other, i.e. if you specify WORKTIME you will probably wish to specify a timeframe called FREETIME to cover the time outside of working hours.

The timeframes "ALWAYS" and "NEVER" are predefined. You can configure other timeframes under:

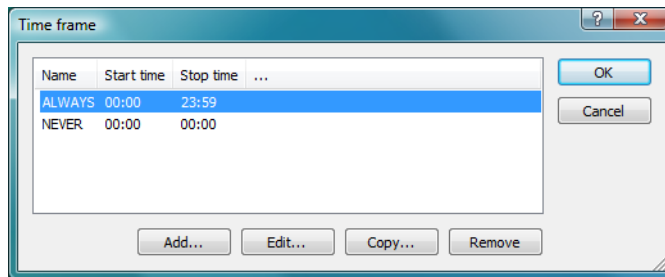

LANconfig: Date/Time / General / Timeframe

WEBconfig: LCOS menu tree / Setup / Time / Timeframe

- Name

Enter the name of the timeframe for referencing from the content-filter profile.

Possible values:

- Name of a timeframe

Default:

- Blank

- Start

Here you set the start time (time of day) when the selected profile becomes valid.

Possible values:

- Maximum 5 characters, format HH:MM

Default:

- 00:00

- Stop

Here you set the stop time (time of day) when the selected profile ceases to be valid.

Possible values:

- Maximum 5 characters, format HH:MM

Default:

- 23:59

- Weekdays

Here you select the weekday on which the timeframe is to be valid.

Possible values:

- Monday, Tuesday, Wednesday, Thursday, Friday, Saturday, Sunday

Default:

- Activated for Monday, Tuesday, Wednesday, Thursday, Friday, Saturday, Sunday

You can form a time schedule with the same name but with different times extending over several lines:

Name	Start time	Stop time	...
ALWAYS	00:00	23:59	
LEISURE	00:00	07:00	
LEISURE	12:01	13:00	
LEISURE	17:01	23:59	
NEVER	00:00	00:00	

## Addition(s) to LCOS 8.50

### Content filter for HTTPS pages

The first version content filter supported only HTTP pages, whereas LCOS 8.50 now also supports HTTPS pages.

By default the content filter uses the firewall rule 'CONTENT-FILTER'. When the content filter option is activated on a device with LCOS 8.50 or newer, the rule refers to the target 'WEB', which monitors outbound HTTP and HTTPS connections on ports 80 and 443.



If you enabled the content filter option on a device with an LCOS version older than 8.50, the firewall rule only uses HTTP port 80 as the target. If this is the case, then you can reset the target of the firewall rule to 'WEB' so that outgoing HTTPS connections are also checked with the content filter.

### One-click override

The override function allows a website to be accessed even though it is classified as forbidden. With this feature enabled, the content filter informs the user why the page was blocked and also provides the option of unlocking the category for the set period of time.

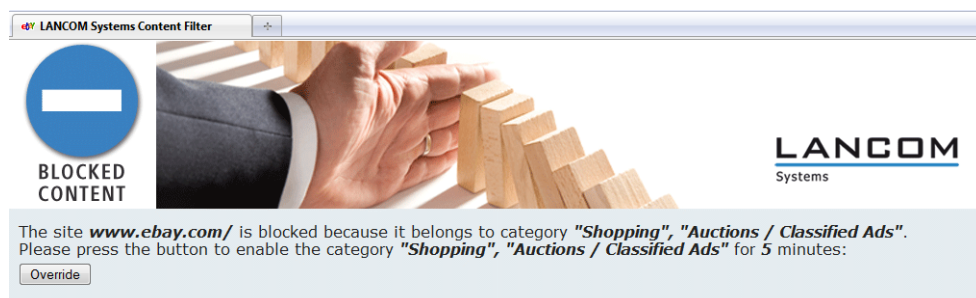

In case of an override, the content filter displays the relevant entry from the block-text table and directly below this, the text from the override-text table together with the 'Override' button. When the user clicks this button the content filter forwards the user to the requested page, if possible. If it is not possible to forward the user to the requested page, the content filter displays an error page.

In the LCOS versions earlier than version 8.50, the block texts, override texts and error texts and associated attributes were used slightly differently than in the LCOS versions 8.50 and newer.

 When updating to LCOS 8.50, you should check the texts in the different tables and adjust them if necessary.

Depending on the application, the arguments relating to HTTP requests are transmitted in different ways according to the requested URL. In most cases, the browser sends a GET request with the arguments in the URL (e.g. a search term). In the case of an override, the content filter is able to forward GET requests as all the required information is included in the URL. However, in some cases the browser sends POST requests, for example for file uploads where the data to be transmitted is in the header of the request. In this case, the information that should be forwarded in case of an override is not contained in the URL. The content filter can only successfully forward post requests in case of an override if JavaScript has been enabled in the user's browser. Browsers based on the HTML rendering library 'WebKit' do not support the override of post requests with JavaScript.

 Content filters operating on a system without JavaScript activated or with WebKit browsers display an error page after clicking on the 'Override' button. These users can then click the button for reloading the web page and forwarding will then succeed.

The following sections show the changes made to the content filter menu system.

#### URL to show on error

This is where you can enter an alternative URL. In the event of an error, the URL entered here will be displayed instead of the usual web site. You can use this external HTML page to display your company's corporate design, for example, or to perform functions such as JavaScript routines, etc. You can also use the same tags here as used in the override text. If you do not make any entry here, the default page stored in the device will be displayed..

**Telnet path:** /Setup/UTM/Content-Filter/Global-Settings

#### Possible values:

- Valid URL address

**Default:** Blank

#### Loopback to use on error

This is where you can configure an optional sender address for the error URL to be used instead of the one that would normally be automatically selected for this target address. If you have configured loopback addresses, you can specify them here as sender address.

**Telnet path:** /Setup/UTM/Content-Filter/Global-Settings

**English description:** Loopback-To-Use-On-Override

#### Possible values:

- Name of the IP networks whose address should be used
- "INT" for the address of the first intranet
- "DMZ" for the address of the first DMZ (Note: If there is an interface named "DMZ", its address will be taken).
- LB0 ... LBF for the 16 loopback addresses
- GUEST
- Any IP address in the form x.x.x.x

**Default:** Blank



 The sender address specified here is used unmasked for every remote station.

### Text

Enter the text that you wish to use as blocking text for this language.

**Telnet path:** /Setup/UTM/Content-Filter/Global-Settings/Block-Text

### Possible values:

- 254 alphanumeric characters

### Default:

Blank

### Special values:

You can also use special tags for blocking text if you wish to display different pages depending on the reason why the web site was blocked (e.g. forbidden category or entry in the blacklist).

The following tags can be used as tag values:

- `<CF-URL/>` for the forbidden URL
- `<CF-HOST/>` or `<CF-DOMAIN/>` displays the host or the domain for the allowed URL. The tags are of equal value and their use is optional.
- `<CF-CATEGORIES/>` for the list of categories why the web site was blocked
- `<CF-PROFILE/>` for the profile name
- `<CF-DURATION/>` displays the override duration in minutes.
- `<CF-OVERRIDEURL/>` for the URL used to activate the URL (this can be integrated in a simple `<a>` tag or in a button)
- `<CF-LINK/>` adds a link for activating the override
- `<CF-BUTTON/>` for a button for activating the override

You can use a tag with attributes to display or hide parts of the HTML document: `<CF-IF att1 att2> ... </CF-IF>`.

### Possible attributes are:

- **BLACKLIST:** If the site was blocked because it is in the profile blacklist
- **FORBIDDEN:** If the site was blocked due to one of its categories
- **CATEGORY:** When the override type is "Category" and the override was successful
- **ERR:** If an error has occurred.

Since there are separate text tables for the blocking page and the error page, this tag only makes sense if you have configured an alternative URL to show on blocking.

- **OVERRIDEOK:** If users have been allowed an override (in this case, the page should display an appropriate button)

If several attributes are defined in one tag, the section will be displayed if at least one of these conditions is met. All tags and attributes can be abbreviated to the first two letters (e.g. CF-CA or CF-IF BL). This is necessary as the blocking text may only contain a maximum of 254 characters.

Example:

- `<CF-URL/>` is blocked because it matches the categories `<CF-CA/>`.`</p><p>Your content profile is <CF-PR/>`.`</p><p><CF-IF OVERRIDEOK></p><p><CF-BU/></CF-IF>`

 The tags described here can also be used in external HTML pages (alternative URLs to show on blocking).

### Text

Enter the text that you wish to use as error text for this language.

**Telnet path:** /Setup/UTM/Content-Filter/Global-Settings/Error-Text

**Possible values:**

254 alphanumerical characters

**Default:**

Blank

**Special values:**

You can also use HTML tags for the error text.

The following empty element tags can be used as tag values:

- `<CF-URL/>` for the forbidden URL
- `<CF-HOST/>` or `<CF-DOMAIN/>` displays the host or the domain for the forbidden URL. The tags are of equal value and their use is optional.
- `<CF-DURATION/>` displays the override duration in minutes.
- `<CF-PROFILE/>` for the profile name
- `<CF-ERROR/>` for the error message

You can use a tag with attributes to display or hide parts of the HTML document: `<CF-IF att1 att2> ... </CF-IF>`.

**Possible attributes are:**

- CHECKERROR: The error occurred while checking the URL
- OVERRIDEERROR: The error occurred while approving an override

**Example:**

`<CF-URL/>` is blocked because an error has occurred:`</p><p><CF-ERROR/>`

`<CF-URL/>`: Blocked URL `<CF-HOST/>` or `<CF-DOMAIN/>`: Host part of the blocked URL `<CF-PROFILE/>`: User content-filter profile `<CF-DURATION/>`: Override time in minutes `<CF-ERROR/>`: Error message `<CF-IF>` to `</CF-IF>`: Conditional evaluation of the following parameters with the logical OR: CHECKERROR: The error occurred while checking the URL (as earlier) OVERRIDE ERROR: The error occurred while approving an override

**Text**

Enter the text that you wish to use as override text for this language.

**Telnet path:** /Setup/UTM/Content-Filter/Global-Settings/Override-Text

**Possible values:**

- 254 alphanumerical characters

**Default:**

Blank

**Special values:**

You can also use HTML tags for blocking text if you wish to display different pages depending on the reason why the web site was blocked (e.g. forbidden category or entry in the blacklist).

The following tags can be used as tag values:

- `<CF-URL/>` for the originally forbidden URL that is now allowed
- `<CF-CATEGORIES/>` for the list of categories that have now been allowed as a result of the override (except if domain override is specified).
- `<CF-BUTTON/>` displays an override button that forwards the browser to the original URL.
- `<CF-BUTTON/>` displays an override link that forwards the browser to the original URL.
- `<CF-HOST/>` or `<CF-DOMAIN/>` displays the host or the domain for the allowed URL. The tags are of equal value and their use is optional.

- `<CF-ERROR/>` generates an error message in the event that the override fails.
- `<CF-DURATION/>` displays the override duration in minutes.

You can use a tag with attributes to display or hide parts of the HTML document: `<CF-IF att1 att2> ... </CF-IF>`.

#### Attributes can be:

- **BLACKLIST:** If the site was blocked because it is in the profile blacklist
- **FORBIDDEN:** If the site was blocked due to one of its categories
- **CATEGORY:** When the override type is "Category" and the override was successful
- **DOMAIN:** When the override type is "Domain" and the override was successful
- **BOTH:** When the override type is "Category-and-Domain" and the override was successful
- **ERROR:** When the override fails
- **OK:** When either **CATEGORY** or **DOMAIN** or **BOTH** are applicable

If several attributes are defined in one tag, the section should be displayed if at least one of these conditions is met. All tags and attributes can be abbreviated to the first two letters (e.g. `CF-CA` or `CF-IF BL`). This is necessary as the blocking text may only contain a maximum of 254 characters.

#### Example:

```
<CF-IF CA BO>The categories <CF-CAT/> are</CF-IF><CF-IF BO> in the domain <CF-DO/></CF-IF><CF-IF DO>The
domain <CF-DO/> is</CF-IF><CF-IF OK> released for <CF-DU/> minutes.</p><p><CF-LI/></CF-IF><CF-IF ERR>Override
error:</p><p><CF-ERR/></CF-IF>
```

## Addition(s) to LCOS 8.80

### Concurrent user model in the content filter

As of LCOS 8.80, the content filter supports a true concurrent user model. This model licenses the number of **concurrent** users of the content filter. In contrast to this, the previous "per-user model" licenses the number of all **potential** users.

Until now, the content filter retained a user in its internal user list for 24 hours. After using the content filter for the first time within a 24-hour period, the user is permanently listed and thus licensed.

As of LCOS 8.80, the content filter only maintains a user in its internal user list for 5 minutes. This change makes it possible for a changing selection of users to use the content filter. Your license now checks only the actual number of concurrent users (within the 5-minute period).

## General settings

Global settings for the LANCOM Content Filter are made here:

LANconfig: Content Filter / General

WEBconfig: LCOS Menu Tree / Setup / UTM / Content-Filter / Global-Settings

- Operating

This is where you can activate the LANCOM Content Filter.

- Action-on-Error:

This is where you can determine what should happen when an error occurs. For example, if the rating server cannot be contacted, this setting either allows the user to surf without restrictions or access to the web is blocked entirely.

Possible values:

- Block, Pass

Default:

- Block

- Action on license exceedance:

This is where you can determine what should happen when the licensed number of users is exceeded. Users are identified by their IP address. The system keeps count of the IP addresses that connect via the LANCOM Content Filter. When the eleventh user establishes a connection with a 10-user license, no further checking is performed by the LANCOM Content Filter. Depending on this setting, the unlicensed user can either surf the web without restrictions, or access to the web is blocked entirely.

Possible values:

- Block, Pass

Default:

- Block

---

 The users of the content filter are automatically removed from the user list when no connection has been made from the IP address concerned via the content filter for 5 minutes.

- Action-on-License-Expiration:

The license to use the LANCOM Content Filter is valid for a certain period. You will be reminded of the license expiry date 30 days, one week and one day before it actually expires (at the e-mail address configured in LANconfig: Log & Trace / General).

This is where you can specify what should happen when the license expires (i.e. block everything or allow everything through). After the license expires, this setting either allows the user to surf the web without restrictions, or access to the web is blocked entirely.

Possible values:

- Block, Pass

Default:

- Block

---

 In order for the reminder to be sent to the specified e-mail address, you must configure the SMTP account.

- Max. proxy connections

This setting is for the maximum allowable number of simultaneous proxy connections. This limits the load that can be placed on the system. A notification is sent if this number should be exceeded. You can set the type of notification under **Content filter > Options > Events**.

Possible values:

- 0 to 999999 connections

Default:

- Depends on device

- Proxy processing timeout

Specifies the maximum time in milliseconds that the proxy can take for processing. A timeout error page is displayed if this time is exceeded.

Possible values:

- 0 to 999999 milliseconds

Default:

- 3000 milliseconds

Special values:

- The value 0 sets no time limit. Values less than 100 milliseconds make no sense.

- Save content filter information to flash ROM activated

If you enable this option, you can additionally save the content filter information to the flash ROM memory of the device.

Default:

- Deactivated

### **New content filter category, Command/Control Server**

As of LCOS 8.80, the content filter supports the new Web filter category Command and Control Server ("C&C server" for short). C&C servers monitor and control bots in a botnet.

## Introduction

The LANCOM Content Filter enables you to filter certain content from your network, so preventing access to Internet pages with content that is illegal or offensive. It also enables you to stop private surfing on specific sites during working hours. This not only increases staff productivity and network security but also ensures that the full bandwidth is available exclusively for your business activities.

The LANCOM Content Filter is an intelligent content filter that works dynamically. It contacts a rating server that evaluates Internet sites reliably and accurately in accordance with the categories that you select.

The LANCOM Content Filter operates by checking the IP addresses behind the URLs that are entered. For any given domain it is possible to differentiate according to the path, meaning that specific areas of a URL may be rated differently.

 It is not possible for users to avoid the LANCOM Content Filter website rating simply by entering the website's IP address into their browsers. The LANCOM Content Filter checks unencrypted (HTTP) and also encrypted Web pages (HTTPS).

The LANCOM Content Filter license you purchase is valid for a certain number of users and for a specific period (for one or three years). You will be informed of the expiry of your license in good time. The number of current users is monitored in the device, with the users being identified by their IP address. You can configure what should happen when the number of licensed users is exceeded: Access can either be denied or an unchecked connection can be made.

 You can test the LANCOM Content Filter on any router that supports this function. All you have to do is to activate a 30-day demo license for each device. Demo licenses are generated directly with LANconfig. Click on the device with the right-hand mouse key and select the context menu entry **Activate Software Option**. In the dialog that follows, click on the button **Register demo license**. You will automatically be connected to the website for the LANCOM registration server. Simply select the required demo license and you can register your device.

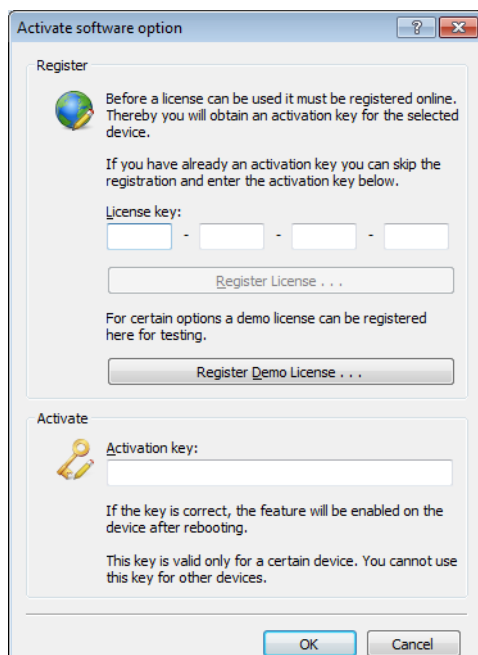

All settings relating to categories are stored in category profiles. You select from predefined main and sub-categories in the LANCOM Content Filter: 59 categories are divided into 14 subject groups such as "Pornography, Nudity", "Shopping" or "Illegal Activities". You can activate or deactivate each of the categories that these groups contain. Sub-categories for "Pornography/Nudity" are, for example, "Pornography/Erotic/Sex" and "Swimwear/Lingerie".

When configuring these categories, administrators have an additional option of activating an override. When the override option is active, users may still access the forbidden site for a particular period of time by clicking on a corresponding button, but the administrator will be notified of this by e-mail, SYSLOG, or SNMP trap.

The category profile, whitelist and blacklist can be used to create a content filter profile that you can assign to particular users by means of the firewall. For example you can create a profile called "Employees\_department\_A" and assign this to all of the computers in that department.

When you install the LANCOM Content Filter, basic default settings are created automatically. These only need to be activated for the initial start. You can subsequently customize the behavior of the LANCOM Content Filter to match your own requirements.

### Additions to the menu system

#### Command/Control server

For each main category and the associated sub-categories, it is possible to define whether the URLs are to be allowed, forbidden or allowed with override only.

**Telnet path:** /Setup/UTM/Content-Filter/Profiles/Category-Profiles

The category profile must subsequently be assigned to a content-filter profile (together with a timeframe) to become active.

#### Possible values:

Allowed, forbidden, override

#### Default:

Forbidden

## 18.16 Addition(s) to LCOS 8.50

### 18.16.1 Bandwidth restriction of the LAN interfaces

#### Introduction

For a device with an integrated WLAN module, you can specify a bandwidth limit for individual LAN ports. The table of LAN interfaces contains the parameters necessary to configure bandwidth restrictions.

#### Additions to the menu system

##### LAN interfaces

This menu contains the settings for the LAN interfaces.

**Telnet path:** Setup/Interfaces/LAN-Interfaces

##### Tx limit

Enter the bandwidth limit (kbps) in the transmission direction. The value 0 means there is no limit.

**Telnet path:** Setup/Interfaces/LAN-Interfaces

##### Possible values:

- Maximum 10 numerical characters

**Default:** 0



This setting is only available for devices with a WLAN module.

**Rx limit**

Enter the bandwidth limit (kbps) in the receive direction. The value 0 means there is no limit.

**Telnet path:** Setup/Interfaces/LAN-Interfaces

**Possible values:**

- Maximum 10 numerical characters

**Default:** 0

---

 This setting is only available for devices with a WLAN module.

## 18.17 Addition(s) to LCOS 8.80

### 18.17.1 LLDP

The Link Layer Discovery Protocol (LLDP) provides a simple and reliable way to exchange information between neighboring devices on the network and for determining the topology of networks. LLDP provides discovery functions to identify individual devices and entire network structures using the procedures defined in the IEEE 802.1AB standard. Since the protocol works on Layer 2 (security level) of the OSI layer model and it is, therefore, used for physically addressing devices, its functionality is not limited to logical networks such as IP networks. In principle, LLDP covers all physically accessible devices on the network.

In particular, the vendor-independent LLDP protocol offers many advantages in complex networks:

- It enables the automatic detection of components attached to a network such as routers, switches, and WLAN access points.
- It simplifies the integration of a wide range of different devices, which support the LLDP standard, into an existing network: Using central network management software, and automatic testing and diagnostic processes, the time required for setup, operation and maintenance of a network is reduced.
- The information sent by the individual devices provides an overview of the topology (i.e., structure and arrangement) of the entire network. Central management software provides the administrator with a virtual image of the network, which is automatically updated when there are changes in the topology.
- With the help of management software, the administrator can also easily monitor and manage complex networks. Using this software, he can determine which components and devices are interconnected and can easily locate any faults.
- LLDP can reduce the costs of buying, building or restructuring a network, since companies are no longer dependent on specific manufacturers because of this open standard. Individual network components can be selected based on which one is best for your implementation. This was previously not possible when proprietary protocols were in use.

**How it works**

LLDP works on a simple principle: The so-called LLDP agent runs on all devices with LLDP support. On the one hand, this software component sends information to all interfaces of the device at regular intervals. This is done using either Unicast or Multicast, depending on the destination addresses, which you can configure as required. On the other hand,



the LLDP agent is continuously receiving information from neighboring devices. The transmission and reception of the respective data packets is handled independently from each other.

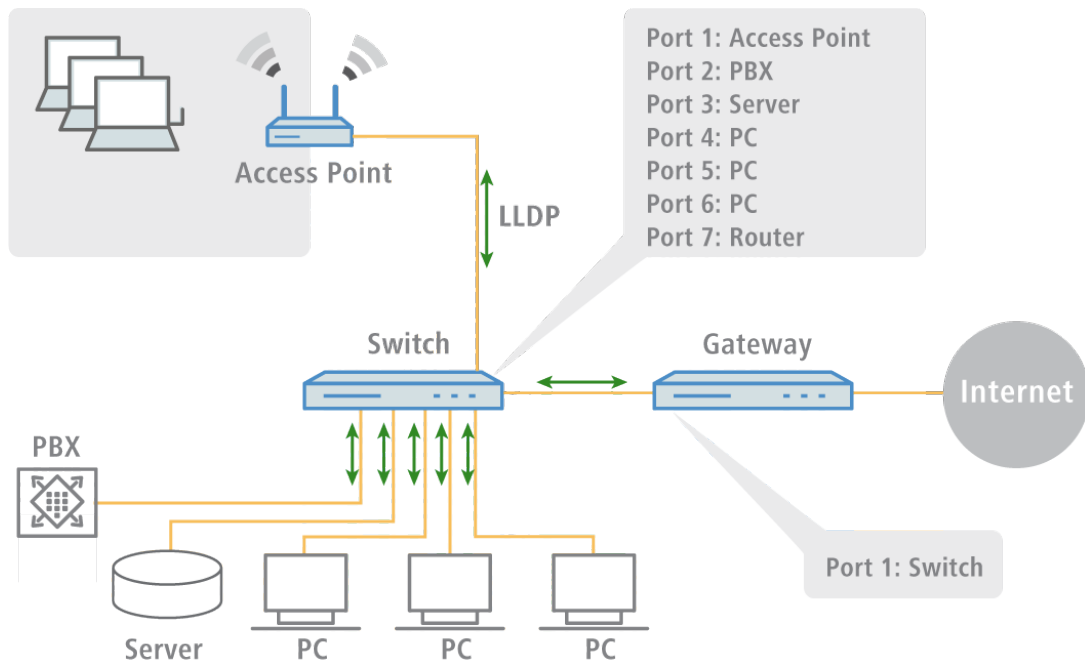

The data packets being sent and received contain information such as the name and the description of the device, the ID and description of ports, the IP address or MAC address of the device, the specific capabilities of the device (e.g., in terms of switching and routing), VLAN identifiers and vendor-specific details. In this case, LLDP defines basic information that a data packet must always include, as well as optional additional information.

The individual devices store the information received locally in a data structure, the so-called MIB (Management Information Base). An MIB therefore contains data from its own LLDP agent and of the detected, direct neighbor agent.

The information exchange provides a continuing identification of the devices within the network, because the devices normally send packets cyclically (i.e. in configurable intervals). Furthermore, the devices also inform their network neighbors when changes occur on the device or in its network connection.

For the actual device identification process it is crucial that each connection point in the topology is clearly identified as a "Media Service Access Point" (MSAP). An MSAP is composed of a device ID (Chassis ID) and a port identification (Port ID). The unique identification or assignment of devices is therefore based on the fact that each MSAP in the monitored network topology may occur only once.

The Administrator can query and capture the data reported by the devices via a central network management software on his computer, where the query of the individual MIBs is performed using the SNMP protocol. The management software thus documents the entire topology of the network and allows automatic display of this topology along with a graphic representation of the current diagnostic data.

### Structure of LLDP messages

Information is exchanged using specific units of data known as LLDP Data Units (LLDPDU). These data unit consists of TLVs (Type-Length-Values), and each TLV field corresponds to a certain type and has a certain length.

In accordance with the LLDP standard IEEE 802.1AB three TLVs are mandatory at the beginning of an LLDPDU in the following order:

- Type 1 = Chassis ID
- Type 2 = Chassis ID
- Type 3 = Time to live

Following these mandatory TLVs, an LLDPDU can include additional, optional TLVs:

- Type 4 = Port description
- Type 5 = System name
- Type 6 = System description
- Type 7 = System capabilities
- Type 8 = Management address

At the end of an LLDPDU the following TLV is mandatory:

- Type 0 = End of LLDPDU

Tabular overview of the TLVs

TLV	Usage	Name	Example	Function
Type 1	Mandatory	Chassis ID	0018.2fa6.b28c	Identifies the device
Type 2	Mandatory	Port ID	Fi-0/12	Identifies the port
Type 3	Mandatory	Time to live	60 sec	Signals to the receiving device how long the received information should remain valid
Type 4	Optional	Port description	GigabitEthernet0/12	Displays details about the port such as the hardware version
Type 5	Optional	System name	PN-I/O 3	Displays the name given to the device by the administrator
Type 6	Optional	System description	LCOS software, version 8.9.1 SE	Displays details about the device such as the version of the networking software
Type 7	Optional	System capabilities	Router	Displays the primary function and capabilities of the device.
Type 8	Optional	Management address	192,168.0.1	Shows the IP or MAC address of the device
Type 0	Mandatory	End of LLDPDU	-----	Signals the end of the data unit

## Supported operating systems

In principle, LLDP works on all popular systems, provided that LLDP agents or an appropriate software for evaluation of the LLDP packages is available. For Linux there are various open source projects, such as "LLDPD", "Open-LLDP" (with hyphen) or "ladvd", which deploy an LLDP agent.

The project "OpenLLDP" aims to achieve a further dissemination and acceptance of the LLDP protocol (802.1AB). The software supports the transmission and reception of LLDP messages on the Linux, Mac OS X, FreeBSD, and NetBSD platforms. Currently, however, this development seems to be stalled.

Microsoft Windows Vista and Windows 7 contain a proprietary protocol called LLTD (Link Layer Topology Discovery), which is essentially the same functionality as LLDP. On Windows XP, the LLTD component can be installed later as a patch. However, the patch is limited compared to the features implemented in Vista and Windows 7 because the "LLTD Responder" only reports IPv4 addresses, and not IPv6 addresses.

If you want to install LLDP on Windows systems, you can use a shareware called "haneWIN LLDP Agent". Using this, LLDP works on all Windows systems as of Windows 2000, i.e., on both 32-bit and 64-bit systems.

The most widely used free software for evaluation and analysis is Wireshark. The basic version of Wireshark is free of charge and now well-established as a standard. The software supports a wide variety of operating systems and can read and evaluate a wide variety of protocols (including LLDP). However, the focus of the basic version of Wireshark is the analysis of problems within the network. If you need more features (such as the visualization of network traffic in the form of colored graphs), you can purchase add-on modules.

## Additions to the menu system

### Additions to the Setup menu

#### LLDP

This submenu contains the configuration options relating to the Link Layer Discovery Protocol (LLDP). The options are similar to the configuration options according to LLDP MIB. If the information contained here is not sufficient, you can find more details in the IEEE 802.1AB standard.

#### SNMP ID:

2.38

#### Telnet path:

**Setup > LLDP**

### Management addresses

In this table, enter the management address(es) that the device transmits via LLDPDUs. Management addresses take their names from the TCP/IP network list. The device only transfers the network and management addresses in this table for the LLDPDUs. A network from this list has the option of using the port list to limit the wider disclosure of the individual device addresses.

#### SNMP ID:

2.38.7

#### Telnet path:

**Setup > LLDP > Management-Addresses**

 Defining address bindings limits the disclosure of management addresses regardless of the settings in the port lists. The device only reports a network that is connected to an interface. This is irrespective of the settings of the port list.

#### Network name

The name of the TCP/IP network, as entered in the TCP-IP network list.

#### SNMP ID:

2.38.7.1

#### Telnet path:

**Setup > LLDP > Management-Addresses > Network-Name**

#### Possible values:

Max. 16 alphanumerical characters

#### Default:

Blank

#### Port list

The list of interfaces and ports belonging to the corresponding management address.

#### SNMP ID:

2.38.7.2

#### Telnet path:

**Setup > LLDP > Management-Addresses > Port-List**

**Possible values:**

>Comma-separated list of ports, max 251 alphanumeric characters, e.g., LAN-1 or WLAN-1. Use wildcards to specify a group of ports (e.g., "\*\_\*").

**Default:**

Blank

**Ports**

This table includes all port-dependent configuration options. The table index is a string, specifically the interface/port name.

**SNMP ID:**

2.38.6

**Telnet path:**

**Setup > LLDP > Ports**

Name

The name of the port or interface

**SNMP ID:**

2.38.6.1

**Telnet path:**

**Setup > LLDP > Ports > Name**

**Possible values:**

Depending on the interfaces, e.g., LAN-1, WLAN-1

Admin status

Specifies whether PDU transfer and/or reception is active or inactive on this port. This parameter can be set individually for each port.

**SNMP ID:**

2.38.6.2

**Telnet path:**

**Setup > LLDP > Ports > Admin-Status**

**Possible values:**

Off

TX only

RX only

Rx/Tx

**Default:**

Off

Notification

Use this to set whether changes in an MSAP remote station for this port are reported to possible network management systems.

**SNMP ID:**

2.38.6.3

**Telnet path:****Setup > LLDP > Ports > Notifications****Possible values:**

No

Yes

**Default:**

No

Admin status

Specify the quantity of the optional standard TLVs that will be transmitted to the PDUs.

**SNMP ID:**

2.38.6.4

**Telnet path:****Setup > LLDP > Ports > TLVs****Possible values:**

Port description

System name

System description

System properties

None

**Default:**

Port description

TLVs-802.3

Specify the quantity of the optional standard TLVs-802.3 that will be transmitted to the PDUs.

**SNMP ID:**

2.38.6.6

**Telnet path:****Setup > LLDP > Ports > TLVs-802.3****Possible values:**

PHY config status

Power via MDI

Link aggregation

Max frame size

None

**Default:**

PHY config status

Maximum neighbors

This parameter specifies the maximum number of LLDP neighbors.

**SNMP ID:**

2.38.6.7

**Telnet path:****Setup > LLDP > Ports > Max-Neighbors****Possible values:**

0 to 65535

**Default:**

0

## Update source

This parameter specifies the optional sources for LLDP updates.

**SNMP ID:**

2.38.6.8

**Telnet path:****Setup > LLDP > Ports > Update-Source****Possible values:**

Auto

LLDP only

Other only

Both

**Default:**

Auto

## TLVs-LCS

These settings define the quantity of the optional standard LCS TLVs that the device sends to PDUs.

**SNMP ID:**

2.38.6.9

**Telnet path:****Setup > LLDP > Ports > TLVs-LCS****Possible values:**

SSID

Radio channel

PHY type

None

**Default:**

SSID

**Protocol**

This table contains the LLDP port settings for the spanning-tree and rapid-spanning-tree protocols.

**SNMP ID:**

2.38.8

**Telnet path:****Setup > LLDP > Protocols**

## Protocol

This parameter sets the protocol for which the LLDP ports are enabled.

**SNMP ID:**

2.38.8.1

**Telnet path:**

**Setup > LLDP > Protocols > Protocol**

**Possible values:**

Spanning-Tree

Rapid-Spanning-Tree

**Default:**

Spanning-Tree, Rapid-Spanning-Tree

## Port list

This value describes the ports, which the LLDP uses with the associated protocol (spanning-tree or rapid-spanning-tree).

**SNMP ID:**

2.38.8.2

**Telnet path:**

**Setup > LLDP > Protocols > Port-List**

**Possible values:**

>Comma-separated list of ports, max 251 alphanumeric characters, e.g., LAN-1 or WLAN-1. Use wildcards to specify a group of ports (e.g., "\*\_\*").

**Default:**

Blank

**Notification interval**

This value specifies the time interval until the device sends notifications of changes to the remote station tables. The value defines the smallest time period between notifications. Thus the default value of 5 seconds causes the device to send messages at most once every 5 seconds, even if the device has detected multiple changes in the meantime.

**SNMP ID:**

2.38.5

**Telnet path:**

**Setup > LLDP > Notification-Interval**

**Possible values:**

0 to 9999 seconds

**Default:**

5

**Operating**

This parameter enables or disables the use of LLDP.

**SNMP ID:**

2.38.10

**Telnet path:****Setup > LLDP > Operating****Possible values:**

Yes

No

**Default:**

No

**Message TX hold multiplier**

This value is used to calculate the time in seconds after which the device discards the information received with LLDP messages (hold time or time to live – TTL). The device calculates this value as the product of the *Message TX hold multiplier* specified here and the current *Message TX interval*:

$$\text{Hold time} = \text{Message TX hold multiplier} \times \text{Message TX interval}$$

The default settings result in a hold time for received LLDP messages of 120 seconds.

**SNMP ID:**

2.38.2

**Telnet path:****Setup > LLDP > Message-TX-Hold-Multiplier****Possible values:**

0 to 99

**Default:**

4

**Message TX interval**

This value defines the interval in seconds for the regular transmission of LLDPDUs by the device.



If the device detects changes to the LLDP information during an interval, the device can send additional LLDP messages. The *Tx delay* parameter defines the maximum frequency of LLDP messages caused by these changes.



The device also uses this *Message TX interval* for calculating the hold time for received LLDP messages with the help of the *Message TX hold multiplier*,

**SNMP ID:**

2.38.1

**Telnet path:****Setup > LLDP > Message-TX-interval****Possible values:**

0 to 65535 seconds

**Default:**

30

**Reinit delay**

This value defines the time the device suppresses transmission of LLDPDUs despite the LLDP being activated.



**SNMP ID:**

2.38.3

**Telnet path:****Setup > LLDP > Reinit-Delay****Possible values:**

0 to 99 seconds

**Default:**

2

**Immediate delete**

This parameter enables or disables the direct deletion of LLDPDUs.

**SNMP ID:**

2.38.9

**Telnet path:****Setup > LLDP > Immediate-Deletion****Possible values:**

Yes

No

**Default:**

Yes

**Tx delay**

In principle the device sends LLDP messages in the interval set under *Message TX interval*. If the device detects changes to the LLDP information during an interval, the device can send additional LLDP messages.

The value set here defines the maximum frequency in seconds, in which the device uses LLDP messages. Thus the default value of 2 seconds causes the device to send LLDP messages once every 2 seconds, even if the device has detected multiple changes in the meantime.

**SNMP ID:**

2.38.4

**Telnet path:****Setup > LLDP > Tx-Delay****Possible values:**

0 to 9999 seconds

**Default:**

2

## 19 Appendix

### 19.1 Error messages in LANmonitor

It is possible to read out VPN error messages over the LANmonitor.

#### 19.1.1 General error messages

Connection attempt cancelled	
Connection establishment failed (D-channel layer 1)	Bus activation failed
Connection establishment failed (D-channel layer 2)	no UA on SABME
Connection establishment failed (Layer 1)	a/b ports
Connection establishment failed (Layer 2)	a/b ports
ISDN line error (Layer 1)	Cable not connected
Connection aborted (layer 2)	X.75 / V.110
Local error	Required resource not available -> ISDN problem; boot telecommunications system
PP login at remote site - PAP rejected	Remote device can only handle PAP, but CHAP is required
PPP login from remote site - timeout (PPP-PAP RX)	Remote did not send PAP request
PPP login at remote site - timeout (PPP-PAP TX)	Remote did not respond to PAP request
PPP login from remote site - CHAP rejected	a CHAP reject was received after a CHAP challenge
PPP login from remote site - timeout (PPP-CHAP RX)	Remote did not send CHAP response
PPP login at remote site - timeout (PPP-CHAP TX)	Remote did not respond to CHAP response
Time limit exceeded	exactly like fee limit... .
Connection establishment failed (Layer 1)	no HDLC flags found
Connection establishment failed (Layer 2)	X.75 / V.110 not working
DSL line error (Layer 1)	Cable not connected

#### 19.1.2 VPN error messages

 For correct evaluation of error messages for VPN connections, at least LCOS version 3.22 must be installed on both LANCOM devices.

A VPN connection is always either an outgoing or an incoming connection. To make searching for the error faster and more efficient, the error messages are different for the initiator and the responder. The initiator is the remote device which initiates the connection. The responder is the device which receives the connection. After the error message is read out, look in the appropriate menu item on the corresponding remote.

Example:

For the error message 'IKE or IPSec establishment timeout (Initiator)', no direct error can be determined. The responder, however, has determined an error like 'No proposal matched (Responder, IPSec)', which it send to an SNMP client

(LANmonitor) using an SNMP trap. Using this error message, the corresponding parameter in the configuration can be checked and changed if necessary. Thus it is always necessary to verify the error messages on both sides.

Message	Initiator	Responder	
License exceeded - no more VPN tunnels available (Responder, IKE)	x	x	The maximum number of possible VPN channels has been reached.
No route to remote gateway	x	x	The router to the remote gateway could not be found. Please check the public IP address or the DynDNS name of the remote device.
Dynamic VPN - no PPP table entry matched	x		In dynamic VPN, the outgoing call could not be authenticated with the PPP data sent. Please check the PPP username and PPP password on both sides under "Configure --> Communication --> Protocols --> PPP list --> Remote site".
Dynamic VPN - no PPP table entry matched		x	The incoming call cannot be authenticated with the PPP data received. Please check the PPP username and PPP password on both sides under "Configure --> Communication --> Protocols --> PPP list --> Remote site".
IKE or IPSec establishment timeout	x	x	A time limit was reached. The router on the remote side is no longer responding. Please check the VPN error message in the LANmonitor on the remote device.
Line polling to remote gateway failed			The LCP polling failed. Please check on the remote device whether ping blocking is enabled in the firewall menu under "Configure --> Firewall --> General --> Ping blocking"
No entry in polling table and keep alive in configured			The holding time of the VPN tunnel under "Configure --> VPN --> Connection list --> Names" is set to Short hold (9999 sec.). However, the required ICMP polling is missing. Please add them under "Configure --> Communication --> Remote Sites --> Polling Table". As remote site, enter the VPN remote device, for the IP address enter an IP address from the LAN at the remote site.
Dynamic VPN - predefined charge limit exceeded	x		The fee limit under "Configure --> Costs --> Fees - Limit (ISDN)" was reached. Please reboot the device.
Dynamic VPN - preset time limit exceeded	x		The time limit under "Configure --> Costs --> Time limit (ISDN)" was reached. Please reboot the device.
Dynamic VPN - no ISDN call number for negotiator channel	x		The ISDN call number for the remote device for dynamic VPN is missing. Please enter the call number under "Configure --> Communication --> Remote sites --> Name list (ISDN) --> Name".
Dynamic VPN - Multiple connections on ISDN interface for negotiator channel not allowed			While establishing multiple ISDN connections, a limit was reached. Please check under "Configure --> Management --> Interfaces --> Interface Settings --> ISDN --> Max. outgoing calls".
Predefined charging limit exceeded	x		The fee limit under "Configure --> Management --> Costs --> Charge limit (ISDN)" was reached. Indicated by a synchronized blinking of the Power LED.
Predefined time limit exceeded	x		The time limit under "Configure --> Management --> Costs --> Time Limit (ISDN)" was reached. Indicated by a synchronized blinking of the Power LED.
No IP address for PPTP server	x		The IP address of the PPTP selected has not been entered. Enter the IP address under "Configure --> Communication --> Protocols --> PPTP list". Also see .

Message	Initiator	Responder	
Exchange type mismatch (Main or Aggressive mode)		x (IKE)	The exchange type does not match that of the remote device. Please check the value under "Configure --> VPN --> Connection list --> Edit VPN remote site entry --> IKE Exchange"
No proposal matched	x (IKE)		The IKE proposals do not match. --> Check VPN rules
No proposal matched		x (IKE)	The IKE proposals do not match. --> Check VPN rules
IKE group mismatch		x (IKE)	Please check the IKE groups on both sides under "Configure --> VPN --> Connection parameters --> VPN remote site identification --> IKE Group"
Life type unsupported (other than Kbytes or seconds?)		x (IKE)	The value for the lifetime is not supported. Please use a life type in "sec = seconds" or "kb = kilobytes". Check this entry under "Configure --> VPN --> Parameters --> Lifetime"
Lifetime mismatched		x (IKE)	The lifetime specified does not match that of the remote device. Check this entry under "Configure --> VPN --> Parameters --> Lifetime"
ID type value unsupported (other than IP network, domain, or email)		x (IKE)	False entry of identity. Please correct your entry under "Configure --> VPN --> IKE --> IKE key"
ID type mismatch (e.g. IP network, domain, or email)		x (IKE)	The two sites are using different identities. Compare the identification at both sites under "Configure --> VPN --> IKE --> IKE key"
No rule matched ID - unknown connection or wrong ID (e.g. remote gateway definition)		x (IKE)	The incoming VPN connection could not be assigned to a remote device.
IKE key mismatch	x (IKE)		Please compare the preshared keys under "Configure --> VPN --> IKE --> IKE key"
IKE key mismatch		x (IKE)	Please compare the preshared keys under "Configure --> VPN --> IKE --> IKE key"
Out of memory	x (IKE)		The number of VPN connections has overloaded the device's memory. To maintain the stability of the device, no further VPN connections should be established.
Out of memory		x (IKE)	The number of VPN connections has overloaded the device's memory. To maintain the stability of the device, no further VPN connections should be established.
No rule matched IDs - unknown connection or wrong ID (e.g. IP network definition)		x (IKE)	The incoming VPN connection could not be assigned to a remote device. Please check the following parameters: ID type does not match (see this document), incorrect network definition, VPN rules do not match (see VPN RULES).
No proposal matched	x (IPsec)	x (IPsec)	The devices cannot agree on a matching proposal. Please check the settings under "Configure --> VPN --> IKE --> IKE Proposals" and under "Configure --> VPN --> IPsec parameters --> IPsec proposal lists".
IPSec PFS group mismatch			Please check the PFS (Perfect Forward Sequence) under "Configure --> VPN --> Connection parameters --> VPN remote identification --> PFS Group"

## 19.2 SNMP Traps

MIB2 Traps	Explanation
coldstart	Device was restarted by switching power off and on.
warmstart	LCOS was restarted, for instance by a software reboot
authentication failed (= console login failed)	Login failed during access to the configuration

Enterprise specific Traps	Explanation
Firmware upload started	Firmware upload was started
Configuration upload started	The reading of the firmware or configuration was started
Upload succeeded	The reading of the firmware or configuration was successful
Upload failed (timeout)	The reading of the firmware or configuration failed: maximum time was exceeded
Upload failed (incomplete)	The reading of the firmware or configuration failed: incomplete configuration
Upload failed (bad device)	The reading of the firmware or configuration failed: wrong device
Configuration download started	Output of the configuration was started
Download succeeded	Output of the configuration was successful
Console login	Login to configuration successful
Console logout	Logout from configuration was successful
Firewall trap	Information about a firewall event
Connection status	WAN connection status
VPN Connection status	Status of VPN connection
WAN-Ethernet UP/DOWN	WAN interface available or not available

WLAN traps	Operating mode	Explanation
WLAN Scan started	Access point or client	The WLAN station has started a scan for free radio channels
Started WLAN BSS ID	Access point	The WLAN station has created a new radio cell
Joined WLAN BSS ID	Client	The WLAN station has found a radio cell
Authenticated WLAN station	Access point	The authentication of a client WLAN station was successful
Deauthenticated WLAN station	Access point	The client WLAN station has signed off
Associated WLAN station	Access point	Client WLAN station connected
Reassociated WLAN station	Access point	Client WLAN station has reconnected, was previously signed in to another access point
RADIUS access check for WLAN station succeeded	Access point	Checking of RADIUS access to the WLAN station was successful
RADIUS access check for WLAN station failed	Access point	Checking of RADIUS access to the WLAN station was unsuccessful
Disassociated WLAN station due to station request	Access point	WLAN station was signed off due to a request from the station
Rejected association from WLAN station	Access point	The sign on of the WLAN station was rejected

WLAN traps	Operating mode	Explanation
WLAN card hung, resetting	Access point or client	WLAN card stopped, reset

## 19.3 Radio channels

### 19.3.1 Radio channels in the 2,4 GHz frequency band

In the frequency range from 2400 to 2483 MHz are up to 13 channels available. The following overview shows which channels are supported by the different regions (EU/WORLD). The last column shows which channels can be used without overlapping.

Frequency range	2400–2500 MHz		no overlapping with
Channel No.	EU (ETSI)	WORLD (ETSI + FCC)	
1	2412	2412	6, 11
2	2417	2417	7
3	2422	2422	8
4	2427	2427	9
5	2432	2432	10
6	2437	2437	1, 11
7	2442	2442	2
8	2447	2447	3
9	2452	2452	4
10	2457	2457	5
<b>11</b>	<b>2462</b>	<b>2462</b>	1, 6
12	2467	–	–
13	2472	–	–

Bold values indicate the default setting of the LANCOM DSL/I-10 Office radio adapters when utilized in a base station.

### 19.3.2 Radio channels in the 5 GHz frequency band

In the frequency range from 5,13 to 5,805 GHz up to 19 non-overlapping channels are available in Europe, defined as the sub-bands as follows:

- Band 1: 5150 - 5350 MHz (channels 36, 40, 44, 48, 52, 56, 60 and 64)
- Band 2: 5470 - 5725 MHz (channels 100, 104, 108, 112, 116, 120, 124, 128, 132, 136 and 140)
- Band 3: 5725 - 5875 MHz (channels 147, 151, 155, 167)

 Please note that frequency ranges and radio channels in band 3 are reserved for operation in UK only!

The following overview shows which channels are allowed in different regions.

	Channel No.	Frequency	ETSI (EU)	FCC (US)
<b>Band 1</b>	36	5,180 GHz	yes	yes
	40	5,200 GHz	yes	yes

	Channel No.	Frequency	ETSI (EU)	FCC (US)
<b>Band 2</b>	44	5,220 GHz	yes	yes
	48	5,240 GHz	yes	yes
	52	5,260 GHz	yes	yes
	56	5,280 GHz	yes	yes
	60	5,300 GHz	yes	yes
	64	5,320 GHz	yes	yes
	100	5,500 GHz	yes	no
	104	5,520 GHz	yes	no
	108	5,540 GHz	yes	no
	112	5,560 GHz	yes	no
	116	5,580 GHz	yes	no
	120	5,600 GHz	yes	no
	124	5,620 GHz	yes	no
	128	5,640 GHz	yes	no
	132	5,660 GHz	yes	no
<b>Band 3 (UK only)</b>	136	5,680 GHz	yes	no
	140	5,700 GHz	yes	no
	147	5,735 GHz	no	yes
	151	5,755 GHz	no	yes
	155	5,775 GHz	no	yes
	167	5,835 GHz	no	yes

### 19.3.3 Radio channels and frequency ranges for Indoor and Outdoor operating

In several countries specific regulations are valid concerning the use of frequency ranges and radio channels for indoor and outdoor operating. The following table gives information on the permitted application:

Country	Band (GHz)	Sub band	Frequency	Channels	Turbo channels	Emitted power (dBm)	Indoor/ Outdoor
Germany, Austria, Switzerland, Netherlands, Belgium, Luxembourg, Italy, Malta, France	2,4	1	2,4-2,4835	1-13	6	100/20	I+O
UK	5	1	5,15-5,35	36-64	42-58	200/23	I
		2	5,470-5,725	100-140	106-130	1000/30	I+O
	2,4	1	2,4-2,4835	1-13	6	100/20	I+O
		3	5,725-5,585	147, 151, 155, 167	—	2000/33,1	(only fixed WLAN outdoor installations!)
Czechia	2,4	1	2,4-2,4835	1-13	6	100/20	I+O

Country	Band (GHz)	Sub band	Frequency	Channels	Turbo channels	Emitted power (dBm)	Indoor/ Outdoor
	5	1	5,15-5,35	36-64	42-58	200/23	I

Further details to the restrictions for the use of wlan adapters within the EU can be found in the internet:

Country	Organization	Link
Belgium	Institut Belge des Postes et Telecommunications (BIPT)	<a href="http://www.bipt.be">www.bipt.be</a>
Denmark	National Telecom Agency	<a href="http://www.tst.dk">www.tst.dk</a>
Germany	Regulierungsbehörde für Telekommunikation und Post	<a href="http://www.regtp.de">www.regtp.de</a>
Finland	Finnish Communications Regulatory Authority (FICORA)	<a href="http://www.ficora.fi">www.ficora.fi</a>
France	Autorité de Régulation des Télécommunications (ART)	<a href="http://www.art-telecom.fr">www.art-telecom.fr</a>
Greece	National Telecommunications Commission (EET)	<a href="http://www.eett.gr">www.eett.gr</a>
Great Britain	Office of Telecommunications (OfTel)	<a href="http://www.oftel.gov.uk">www.oftel.gov.uk</a>
	Postal Services Commission (Postcomm)	<a href="http://www.postcomm.gov.uk/">www.postcomm.gov.uk/</a>
	Radiocommunications Agency	<a href="http://www.open.gov.uk/radiocom">www.open.gov.uk/radiocom</a>
Ireland	Commission for Communications Regulation (ComReg)	<a href="http://www.comreg.ie">www.comreg.ie</a>
Iceland	Post and Telecom Administration (PTA)	<a href="http://www.pta.is">www.pta.is</a>
Italy	L'Autorità per le garanzie nelle comunicazioni (AGC)	<a href="http://www.agcom.it">www.agcom.it</a>
Latvia	Telecommunication State Inspection	<a href="http://www.vei.lv">www.vei.lv</a>
Liechtenstein	Amt für Kommunikation (AK)	<a href="http://www.ak.li">www.ak.li</a>
Lithuania	Radio Administration	<a href="http://www.rrt.lt/">www.rrt.lt/</a>
Luxembourg	Institut Luxembourgeois des Télécommunications (ILT)	<a href="http://www.etat.lu/ILT">www.etat.lu/ILT</a>
Netherlands	Onafhankelijke Post en Telecommunicatie Autoriteit (OPTA)	<a href="http://www.opta.nl">www.opta.nl</a>
	Agentschap Telecom	<a href="http://www.agentschap-telecom.nl">www.agentschap-telecom.nl</a>
	Ministerie Economische Zaken	<a href="http://www.ez.nl">www.ez.nl</a>
Norway	Norwegian Post and Telecommunications Authority (NPT)	<a href="http://www.npt.no">www.npt.no</a>
Austria	Rundfunk und Telekom Regulierungs-GmbH	<a href="http://www.rtr.at">www.rtr.at</a>
	Bundesministerium für Verkehr, Innovation und Technologie	<a href="http://www.bmvit.gv.at">www.bmvit.gv.at</a>
Poland	Urząd Regulacji Telekomunikacji (URT)	<a href="http://www.urt.gov.pl">www.urt.gov.pl</a>
Portugal	Autoridad Nacional De Comunicações (ICP-Anacom)	<a href="http://www.anacom.pt">www.anacom.pt</a>
Sweden	National Post and Telecom Agency	<a href="http://www.pts.se">www.pts.se</a>
Switzerland	Bundesamt für Kommunikation	<a href="http://www.bakom.ch">www.bakom.ch</a>
Slowenia	Agencija za telekomunikacije, radiodifuzijo in pošto	<a href="http://www.atrp.si">www.atrp.si</a>



Country	Organization	Link
Spain	Comision del Mercado de las Telecomunicaciones (CMT)	<a href="http://www.cmt.es">www.cmt.es</a>
Czechia	Czech Telecommunication Office	<a href="http://www.ctu.cz">www.ctu.cz</a>
Hungary	Communication Authority (HIF)	<a href="http://www.hif.hu">www.hif.hu</a>

 Please inform yourself about the current radio regulations of the country you want to operate a Wireless LAN device.

## 19.4 RFCs supported

RFC	Title
1058	Routing Information Protocol
1331	The Point-to-Point Protocol (PPP) for the Transmission of Multi-protocol Datagrams over Point-to-Point Links
1334	PPP Authentication Protocols
1389	RIP Version 2 MIB Extensions
1483	Multiprotocol Encapsulation over ATM Adaptation Layer 5
1542	Clarifications and Extensions for the Bootstrap Protocol
1552	The PPP Internetworking Packet Exchange Control Protocol (IPXCP)
1577	Classical IP and ARP over ATM
1631	The IP Network Address Translator (NAT)
1877	PPP Internet Protocol Control Protocol Extensions for Name Server Addresses
1974	PPP Stack LZS Compression Protocol
2284	Extensible Authentication Protocol
2104	HMAC: Keyed-Hashing for Message Authentication
2131	Dynamic Host Configuration Protocol
2132	DHCP Options and BOOTP Vendor Extensions
2225	Classical IP and ARP over ATM
2364	PPP Over AAL5
2401	Security Architecture for the Internet Protocol
2402	IP Authentication Header
2403	The Use of HMAC-MD5-96 within ESP and AH
2404	The Use of HMAC-SHA-1-96 within ESP and AH
2405	The ESP DES-CBC Cipher Algorithm With Explicit IV
2406	IP Encapsulating Security Payload (ESP)
2407	The Internet IP Security Domain of Interpretation for ISAKMP
2408	Internet Security Association and Key Management Protocol (ISAKMP)
2409	The Internet Key Exchange (IKE)
2410	The NULL Encryption Algorithm and Its Use With IPsec

RFC	Title
2412	The OAKLEY Key Determination Protocol
2451	The ESP CBC-Mode Cipher Algorithms
2516	A Method for Transmitting PPP Over Ethernet (PPPoE)
2684	Multiprotocol Encapsulation over ATM Adaptation Layer 5
3280	Internet X.509 Public Key Infrastructure Certificate and Certificate Revocation List (CRL) Profile

## 19.5 Glossary

802.11	Wireless LAN specification of the IEEE; data rate up to 2 Mbps; in 2.4 GHz ISM band; FHSS and DSSS; infrared spectrum communications also planned
802.11a	Extension to 802.11; data rate up to 54 Mbit/s; in 5 GHz band; OFDM
802.11b	Extension to 802.11; data rate up to 11 Mbit/s; in 2.4 GHz band; high market penetration; DSSS/CCK
802.11g	Extension to 802.11; data rate up to 54 Mbit/s; in 2.4 GHz band; OFDM and DSSS
802.11h	802.11a customization, data rate up to 54 Mbit/s; in 5 GHz band; in area of transmission power and frequency management; for use in Europe; OFDM
802.11i	Future 802.11 extension with additional security features
802.1x	Specification of a port-based authentication mechanism from the IEEE
AES	Advanced Encryption Standard
Access point	Base station in a wireless LAN; independent LAN-WLAN bridge; connects stations of a LAN (local network) with a WLAN (wireless network) in a point-to-multipoint mode; connects two networks over a wireless network in point-to-point mode
Access router	Active network component for connection of a local network to the Internet or a company network
ADSL	Asymmetrical Digital Subscriber Line - transmission process for high-speed data transmission over normal telephone lines. With ADSL, transmissions (downstream) of up to 6 Mbps can be implemented over normal telephone lines; for bidirectional transmission there is a second frequency band with transmission speeds of up to 640 kbps (upstream) - hence the name "asymmetric".
Bandwidth	Data rate with which a user can surf the Internet; the higher the bandwidth, the faster the connection
Broadband	Service which provides high bandwidth; e.g.: DSL or WLAN
Bridge	Transport protocol-independent, transparent network component; transmits all packets which are identified as "not local" and only understands the difference between "local" and "remote". Works on Layer 2 of the OSI model
Broadcast	Broadcasts are packets to all stations of a local network; bridges transmit broadcasts; routers do not transmit broadcasts
BSS	Basic Service Set
CAPI	Common ISDN Application Programming Interface - CAPI is a standard for control of ISDN adapters
CCK	Code Complementary Keying; type of modulation used by DSSS
Client	Any computer equipped with a wireless LAN adapter (wireless LAN card), which uses services provided by other participants in the wireless network
CSMA/CA	Carrier Sense Multiple Access with Collision Avoidance; access procedure to the radio channel used under 802.11
CRC	Cyclic Redundancy Check; process for detecting bit errors
Data throughput	Speed at which you can surf on the Internet; depends on the bandwidth and the number of users

DHCP	Dynamic Host Configuration Protocol
DNS	Domain Name Service - computers communicate with computers in remote networks using IP addresses; DNS servers translate names into IP addresses; without DNS servers, you would have to remember all IP addresses and couldn't work with names (e.g. www.lancom.de)
Domain	area of network closed to outside; => Intranet
Download / Downstream	Download / downstream denotes the direction of dataflow in a WAN. Downstream is the direction from the head end or Internet to the participant connected to the network.
DS	Distribution System
DSL	Digital Subscriber Line - DSL procedures include all procedures for digital-broadband use of telephone lines, such as ADSL, HDSL, SDSL, VDSL and so on, which are also called xDSL.
DSSS	Direct Sequence Spread Spectrum; code multiplex -- band spreading process
Dynamic DNS	IPsec-VPN implementation which allows the transparent connection of local networks into a VPN solution, even when their routers work with dynamic addresses (dial-up)
EAP	Extensible Authentication Protocol
EAP-MD5	EAP variant which uses password for one-sided authentication
EAP-TLS	EAP Transport Layer Security; EAP variant which uses certificates for mutual authentication
EAP-TTLS	EAP Tunneled Transport Layer Security; EAP variant which uses certificates for mutual authentication
EIRP	Effective Isotropic Radiated Power
ESS	Extended Service Set
ESSID	Extended Service Set Identity; "network name" of the wireless LAN
Ethernet	Strand or star-formed physical transport medium; all stations can send simultaneously; collisions are detected and corrected through the network protocol
FHSS	Frequency Hopping Spread Spectrum; frequency skipping band spread procedure
Firewall	Protective mechanism for an Intranet against attacks from outside
Frequency	Number of oscillations per second (given in Hertz; 1 Hz = 1 oscillation per second; GHz = Gigahertz = 1 billion Hertz or oscillations per second)
FTP	File Transfer Protocol enables data transfer between different systems and simple file manipulation; FTP is based on the TCP transmission protocol
Frequency band	Contiguous frequency range which has the same transmission properties
Radio frequency	Every radio application uses globally regulated radio frequencies
Gateway	Network component which provides access to other network components on a layer of the => OSI model. Packets which do not go to a local partner are sent to the gateway. The gateway takes care of communication with remote networks.
Hub	Network component; distributor; collector; also used to translate from one connection type to another
HotSpot	Locally limited wireless network with a base station with Internet access; public wireless Internet access
IAPP roaming	Roaming between the cells of a wireless network using IAPP (Inter Access Point Protocol)
IBSS	Independent Basic Service Set
IDS	Intrusion Detection System -- earliest possible detection of attacks on the network
IEEE	Institute of Electrical and Electronics Engineers, New York - www.ieee.org
IP	Internet Protocol
IP masquerading	Combination of PAT (Port Address Translation) and NAT (Network Address Translation) from LANCOM Systems process used for connection of an intranet (multiple workstations) to the Internet over a single IP address; simultaneously, the internal computers are protected from attacks from outside
IPSec	Internet Protocol Security

IP Quality of Service	These functions give precedence to enterprise-critical applications, particular services, or user groups
ISDN	Integrated Services Digital Network -- fast connection; two independent channels; higher transmission rates than analog (up to 128 Kbit/s); uses the old analog lines; comfort features (call forwarding, callback on busy, etc.); supports both analog and digital services
ISM frequency band	Industrial-Scientific-Medical, license-free frequency bands which can be used for industrial, scientific, and medical purposes.
ISP	Internet Service Provider -- service provider with a connection to the Internet (backbone) who provides connection points for end customers
LCOS	LANCOM Operating System - uniform operating system for LANCOM products
LAN	Local Area Network - local network limited to one site
LANcapi	Virtual CAPI which is provided over the network; with LANcapi, which is implemented in all LANCOM routers with ISDN interfaces, a PC connected to the LAN can use ISDN telematic services
LANconfig	Software for configuration of LANCOM devices under Windows
LANtools	Diverse, user-friendly set of tools for the management and monitoring of LANCOM products and systems
MAC	Media Access Control; radio access protocol on ISO Layer 2 data link; it defines packet format, packet addressing, and error detection
MAC address	Serial number of a network component which is assigned by the manufacturer
Mbit	Megabit: standard unit for the specification of data quantities in the context of bandwidths
MIC	Message Integrity Check, cryptographic integrity protection mechanism
NetBIOS	Network Basic Input/Output System. Non-routable network protocol for local networks developed by IBM and later taken over by Microsoft.
NTBA	Network Termination Basic Adaptor . The NTBA (network termination adapter) is responsible in an ISDN base connection for the translation of the connection created by the telephone company to the S0 bus.
OFDM	Orthogonal Frequency Divison Multiplex
PEAP	Protected EAP, EAP variant for mutual authentication
PKI	Public Key Infrastructure
PPP	Point to Point Protocol: network protocol for connections between two computers. PPP is based on TCP/IP.
PPTP	Point to Point Tunneling Protocol: Network protocol for the construction of virtual private networks over the Internet.
Point-to-Multipoint (WLAN)	Multiple WLAN stations log into a base station and constitute a common network with the wired stations
Point-to-Point (WLAN)	Two base stations connect two wired networks over WLAN; point-to-point operation enables coupling of networks even across streets without cables
QoS	Quality of Service (see also IP Quality of Service)
RADIUS	Remote Authentication Dial-In User Service; authentication and monitoring protocol on the application level for authentication, integrity protection, and accounting for network access
RC4	Streaming cipher process by Ron Rivest, "Ron's Code"
RFC	Request for Comments
Router	Intelligent network components; comparable with a post office, which can determine from the logical destination address of a packet which next network component should transmit the packet; knows the overall topology of the network
SDSL	Single Line Digital Subscriber Line - downstream and upstream with 2.048 Mbit/s (two-strand wire)
Server	Computer which provides services over the network (e.g. files, news, email, WWW pages)
SINA	Secure Inter-Network Architecture

SMTP	Simple Mail Transfer Protocol - SMTP protocol is the Internet standard for distribution of electronic mail; the protocol is based on the TCP protocol
SNMPv3	Simple Network Management Protocol Version 3
SSID	Service Set Identity; "network name" of the wireless LAN
SSL	Secure Socket Layer
Splitter	The splitter is comparable with an audio frequency filter; in an ADSL connection, the splitter separates the ISDN signals from the DSL signals; the ISDN signals go to the NTBA and the DSL signals go to the DSL modem
Switch	A central distributor in a star-shaped network; each station has the entire bandwidth available; if a station fails, the rest of the network is not affected; is used for collision prevention; increases the overall throughput of the network; switches are cascadable
TAE	Telephone connection unit used in Germany. Plug for the connection of analog devices like a telephone or modem into the telephone network.
TCP/IP	Transmission Control Protocol/Internet Protocol; family of protocols (ARP, ICMP, IP, UDP, TCP, HTTP, FTP, TFTP) used mainly in the Internet, although it is making headway in intranets as well
TKIP	Temporal Key Integrity
TLS	Transport Layer Security
TPC	Transmission Power Control
Upload/Upstream	Upload / upstream denotes the direction of dataflow in a WAN; upstream is the direction from the node connected to the network to the head end/Internet
Chaining	Concatenation of bit sequences
VPN	Virtual Private Network - a VPN is a network consisting of virtual connections over which non-public or company internal data can be transmitted securely, even if public network infrastructures are used
WAN	Wide Area Network - network connection over long distances (e.g. over ISDN with a LANCOM router)
WECA	Wireless Ethernet Compatibility Alliance; alliance of manufacturers of wireless LAN components based on IEEE 802.11; renamed the WiFi Alliance
WEBconfig	Web-based configuration interface for LANCOM devices.
WEP	Wired Equivalent Privacy
WiFi	Wireless Fidelity; marketing concept generated by the WECA
WiFi-Alliance	Alliance of manufacturers of wireless LAN components based on IEEE 802.11; formerly the WECA
WLAN	Wireless Local Area Network - local radio network
WPA	WiFi Protected Access; name for security mechanisms beyond IEEE 802.11; generated by the WiFi Alliance
WISP	Wireless Internet Service Provider
xDSL	xDSL stands for the family of Digital Subscriber Line technologies
XOR	Logical operation "exclusive OR"